

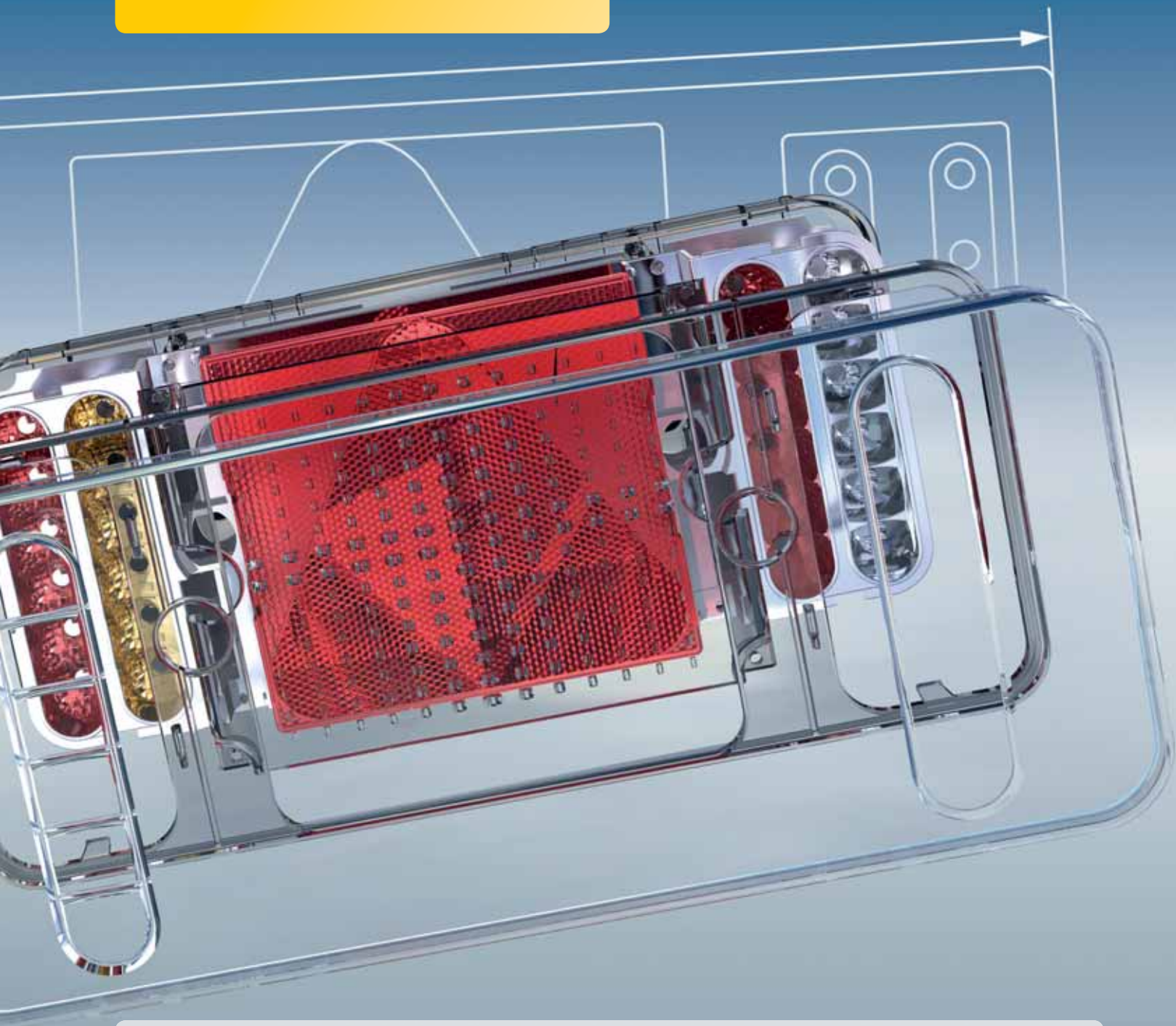

LIGHTING
UNIVERSAL PARTS 2016-17
LEFT HAND DRIVE



HELLA PRINT AND ONLINE CATALOGUES EXPERIENCE HELLA LIVE ON THE INTERNET



**Quickly find the product you need:
with our print and online catalogues**

VEHICLE-SPECIFIC PARTS

www.hella.com/catalogue

Vehicle-specific parts from HELLA can be found in our current print catalogues and in the HELLA online catalogue

The HELLA online catalogue provides you with a comprehensive overview of the products that are compatible with your vehicle in the categories of lighting, electrics/electronics, thermal management and brakes. Regardless of where you are starting your search, the search system helps you find the right solution very quickly. With up-to-date information and the greatest flexibility.

Depending on requirements, you can search for the part required by vehicle or by using a selection of different criteria such as article number, OE number or other information. In addition to extensive basic facts, the online catalogue also features additional information and links to other documents.

UNIVERSAL PARTS

www.hella.com/upc

HELLA universal parts can be found in our current print catalogues and in the online universal parts catalogue.

The online universal parts catalogue offers a quick and up-to-date overview of products in the categories lighting, electrics and thermal management for a wide range of vehicles: passenger cars, trucks, trailers, agricultural and construction machinery, buses and caravans.

TOOLS

www.hella-gutmann.com

Best tools. Efficient repair

To ensure that repair and maintenance work is carried out correctly, we offer professional tools and diagnostic equipment, comprehensive vehicle data and reliable garage units such as tools and devices for light service (headlamp adjustment devices), battery service (battery testers and battery chargers) and manual, inspection and garage lamps.



Experience HELLA live

www.hella.com/onlineservices

Further information on products from the complete HELLA range is available under ONLINE SERVICES

Here you will find a selection of important and interactive information at a glance, presented in a compact and easy-to-read manner: Online tools, configurators and catalogues as well as microsites that target specific customer groups.

Our selection of apps also provide interactive product experiences and practical service for when you are on the move.

Welcome to the mobile world of HELLA!

www.hella.com/apps



LIGHTING 2016 – 17

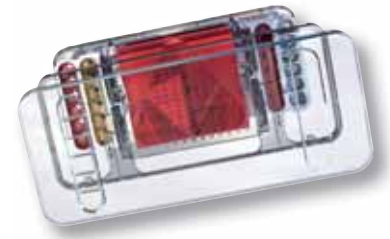

Range overview	2 – 3
Find the right product with ease	4 – 5
1. Universal headlights	1.01 – 1.194
<ul style="list-style-type: none"> Fog lights Driving lights Built-in headlights External fitting headlights 	<ul style="list-style-type: none"> Headlights Work lights Search lights
2. Universal signal lights, reflectors, cabling	2.01 – 2.362
<ul style="list-style-type: none"> Signal lights Light mounts Light series Side marker lights Rear-, clearance- and position lights Position lights Daytime running lights Licence plate lights Track-control lights Rear fog lights Reverse lights Safety brake lights 	<ul style="list-style-type: none"> Indicator lights Indicator lights for two-wheeled vehicles Auxiliary indicators Indicator-position lights Interior lights Reading lights Handlights Door lights Warning lights Hazard flasher lights Emergency triangle Reflectors Signal lights and cabling
3. Optical and acoustic warning systems	3.01 – 3.76
<ul style="list-style-type: none"> Rotating beacons Flashing beacons Warning lights 	<ul style="list-style-type: none"> Optical warning systems Rotating beacon and siren combinations
4. Bulbs	4.01 – 4.20
<ul style="list-style-type: none"> Bulb sets Bulbs for headlights Bulbs for signal lights Fluorescent tubes for ceiling lights Bulbs with glass sockets 	<ul style="list-style-type: none"> Bulbs with plastic caps for dashboard and interior lighting Bulb holders Connectors
5. Overviews	5.01 – 5.84
<ul style="list-style-type: none"> List of part numbers Vehicle manufacturer's no. - HELLA no. 	<ul style="list-style-type: none"> List of type approval numbers - HELLA numbers List of HELLA numbers - type approval numbers

1. UNIVERSAL HEADLAMPS



Just as in broad daylight – that is our motto in developing our headlamps.

HELLA is the number 1 player on the independent component market for vehicle-specific lighting, and has the most extensive market coverage. By leveraging our innovative spirit, which also makes us increasingly attractive for volume-based models in the auto industry, we continue to expand on our entire line of headlamps. Functional safety, a perfect fit and product durability are all guaranteed through 'HELLA Original Parts Quality'.

The end result is frequently nothing less than true lighting innovations that have made driving at night and in poor weather conditions even safer - innovations such as dynamic curve illumination, the AFS adaptive front illumination system, cornering lights, halogen and xenon technology. Our developments simply mean more safety for every driver. We therefore maintain a very large assortment of universal headlamps, work lights, high beam lights and fog lights. HELLA creates milestones of light for you.

2. UNIVERSAL LAMPS, REFLEX REFLECTORS, CABLING SYSTEMS



Communication at light speed.

When driving, understanding is often achieved with light signals. Reliable lights by HELLA are indispensable for safety in traffic. From rear combination lamps and side-marker lamps for clear positioning reference, to braking and indicator lamps for ensuring safety in traffic, through to clearance lights and reflex reflectors that allow you to make your presence unmistakable. An innovative modular and flexible cabling and lighting system also safeguards process reliability as well as a wide variety of hardware for almost all application scenarios.

HELLA's high-performance interior lights will also enable you to find things easily in your vehicle in the middle of the night. Whether you're looking for a crystal clear built-in solution or a flexible reading lamp for good visibility even in the tightest of spaces – HELLA offers you the optimal solution for every vehicle, shape and function.

3. VISUAL AND ACOUSTIC WARNING SYSTEMS



Quality you can rely on time and time again.

The optical warning systems of our OWS series, the signaling systems of the RTK series and beacons mean we consistently implement everything that makes HELLA so special. Rotating beacons, flashing beacons, warning lamps: This is where our specialists combine top technology with extreme robustness.

And the result: High-quality xenon or LED technology, sophisticated rotating mirror technology, which stands up to even the hardest conditions and continual use without any problems.

HELLA thus enables you to be absolutely sure about being seen.

4. BULBS



**Safety is also on board.
Bulbs from HELLA**

As the expert and technological leader in smart light distribution systems, halogen, xenon and full LED headlights, and as a partner to renowned vehicle manufacturers around the world, HELLA meets and exceeds the highest expectations and quality standards.

It is exactly these standards that we place on our comprehensive line of bulbs: Product variety from conventional halogen lights through to stylish (design-oriented) xenon lights, top technology in uncompromisingly high quality that has been thoroughly tested and optimal illumination even in the most severe of weather conditions. This ensures that our long-lasting, robust products not only have the lowest possible failure rates, but are also significantly brighter.

For your own safety on the road.

FIND THE RIGHT PRODUCT WITH EASE

Here you will find a compact, brief overview of important additional information on our comprehensive HELLA product range:

1. UNIVERSAL HEADLAMPS

ELIVER – The light comparison tool

This online tool allows you to compare many HELLA work lights and auxiliary headlamps based on your illumination configuration in a realistic environment.

www.hella.com/eliver



www.hella.com/worklight-configurator

Work light configurator

Which worklight is the right choice for your application? The online configurator from HELLA provides you with matching product recommendations, including all relevant information on the product.



www.hella.com/90mm-modules

90 mm configurator

90 mm modules are used in almost all vehicles. They are small, but powerful. Their modular design allows individual front design. In our 90 mm configurator, you can select and design your own front illumination configuration.



2. UNIVERSAL LAMPS, REFLEX REFLECTORS, CABLING SYSTEMS

www.hella.com/trailer

Website trailer

Discover the HELLA highlights for trailers: Innovative rear combination lamps and reversing lamps, LED interior and licence plate lamps and everything you wanted to know about our cabling and wiring expertise.



www.hella.com/trailertool

Trailer tool

In only 3 steps, the HELLA trailer tool takes you from the light to the technology selection and finally to your individual system proposal. Including application scenarios, a detailed system description, and product recommendations.



3. VISUAL AND ACOUSTIC WARNING SYSTEMS

ELIVER – The light comparison tool

This online tool allows you to compare many HELLA beacons and visual warning systems based on your illumination configuration in a realistic environment.

www.hella.com/eliver



4. BULBS

Lumion – The bulb configurator

The Lumion online tool allows you to quickly and easily find the right bulb for your vehicle. Simply select your vehicle category (passenger cars or trucks), the manufacturer and the model and model year.

www.hella.com/bulbs



OWS⁷ configurator

Configure your own OWS⁷ here. Starting with your vehicle selection, to various roof bar widths, through to individual light modules. It goes without saying that you can also choose additional equipment such as work lights, flashing light signals and lateral close-range illumination.

www.hella.com/ows7



A		I	
Accessories for fog- and driving lights	1.35	Indicator lights	2.207-2.213
Accessories for old-type rotating- and flashing beacons	3.26-3.28	Indicator lights for two-wheeled vehicles	2.213
Accessories for rotating- and flashing beacons	3.24-3.25	Indicator-position lights	2.214-2.217
Accessories for work lights and search lights	1.186-1.190	Informations of LED technology headlights and work lights	1.08-1.09
Accessories for 50 mm dia., 90 mm dia. and 100 mm dia. built-in headlights	1.55	Instructions for LED lights	2.05-2.07
Accessories for signal lights and cabling	2.329-2.330	Interior lights	2.220-2.243
Auxiliary indicators	2.214-2.217		
B		L	
Built-in headlights	1.36-1.68	LED-flashing beacons and spare parts	3.19-3.23, 3.30-3.32
Bulbs with glass sockets	4.11, 4.14-4.16	Licence plate lights	2.180-2.186
Bulbs with plastic caps for dashboard and interior lighting	4.16-4.19	Light mounts	2.56
Bulb holders	4.19	List of part numbers	5.02-5.13
Bulb overview for cars and trucks	4.02	List of type approval numbers	5.62-5.84
Bulb sets	4.03-4.05		
Bulbs for headlights	4.05-4.11	O	
Bulbs for signal lights	4.11-4.15	Optical warning systems OWS 7: product descriptions and spare parts	3.37-3.53
		Optical warning systems OWS 4: Spare parts for old-type systems	3.62
C		Optical warning systems OWS 540 up to 1600: Product descriptions, accessories and spare parts	3.56-3.61
Cabling	2.331-2.338	Optical warning systems OWS-QS: Accessories and spare parts	3.54-3.55
Clearance lights	2.187-2.191	Optical warning systems Raptor: Product descriptions and accessories	3.35-3.36
Connectors	4.20		
Contents fog lights and driving lights	1.02-1.03	P	
Contents headlights and work lights series	1.04	Position lights	2.169-2.170
Contents light series	2.02-2.04		
Contents work lights	1.05-1.07	R	
		Reading lights	2.244-2.246
D		Rear fog lights	2.193-2.196
Daytime running lights	2.171-2.179	Rear warning lights	3.33-3.34
Door lights	2.247-2.249	Rear-, clearance and position lights	2.165-2.168
Driving lights	1.10-1.34	Reflectors	2.255-2.260
		Reverse lights	2.193-2.201
E		Rotating-/flashing beacon and siren combinations RTK 7: product descriptions, accessories and spare parts	3.63-3.73
Emergency triangle	2.254	Rotating beacon and siren combinations RTK-VE 7: product descriptions and accessories	3.74-3.76
External-fitting headlights	1.69-1.82	Rotating beacons and spare parts	3.04-3.13
F		S	
Failure control for LED indicators	2.06-2.07	Safety brake lights	2.202-2.206
Flashing beacons and spare parts	3.14-3.18, 3.29	Searchlights	1.185, 1.191-1.192
Fluorescent tubes for ceiling lights	4.16	Side-marker lights	2.161-2.164
Fog lights and driving lights	1.10-1.34	Signal lights	2.08-2.64
		Signal lights and cabling for towing vehicles, trailers and semi-trailers	2.262-2.338
H		Signal lights and cabling - front	2.262-2.264
Handlights	2.246	Signal lights and cabling - side	2.265-2.270
Hazard flasher lights	2.252-2.253	Signal lights and cabling - rear	2.271-2.328
		Spare parts for old-type rotating/flashing beacons	3.26-3.28



Alphabetical Index

T

Track-control lights	2.192
----------------------	-------

U

Universal light mounts	2.56
------------------------	------

V

VLUEFIT Signal lights	2.239-2.362
-----------------------	-------------

Vehicle manufacturer's no. - HELLA no.	5.14-5.60
--	-----------

W

Warning lights	2.250-2.251
----------------	-------------

Work lights	1.108-1.185, 1.193-1.194
-------------	-----------------------------

Type approval numbers E1 - E26

All HELLA devices have E type approval.
 Exceptions to this are devices with national type approval that are only marked for Germany and equipment for local authority vehicles.
 See overview of type approval numbers in Chapter 5.

What does GGVS/ADR mean?



Some headlights and lights in the range are marked with this symbol. This means that these products are approved for mounting to transport equipment which complies with the requirements of GGVS/ADR B Rn 10251 and Rn 11251 for electrical equipment.

GGVS

Act governing the transportation of hazardous goods by road

ADR

Accord européen relatif au transport international des marchandises dangereuses par route (European Agreement concerning the International Carriage of Dangerous Goods by Road)

What do the IP protective ratings mean?

Protective rating IP5K4K

Dust may only penetrate to such an extent that function and safety are not impaired.
 Water being sprayed against the housing at increased pressure may not have a harmful effect; water pressure approx. 4 bar.

Protective rating IP6K4K

Dust must not penetrate.
 Water being sprayed against the housing at increased pressure may not have a harmful effect; water pressure approx. 4 bar.

Protective rating IPX9K

Water that is directed against the housing during high-pressure/steam jet cleaning may not have a harmful effect; water pressure approx. 80 bar.

Decisive for the specification of the protective rating are the splashwater test and the dust test

The splash-water test provides information about how headlights, lights and beacons resist rain, splashwater, mud and high-pressure cleaners.
 For this purpose, water is sprayed constantly onto the test specimen in a closed chamber as if through a high-pressure cleaner.

The dust test examines the degree to which the test specimen is protected against penetration by solid particles including dust.
 For this purpose, the test sample is exposed to a flow of dust/air mixture for a certain length of time in the chamber.

Lighting technology - examples for terminal descriptions according to DIN 72552

54	Trailer signals, trailer plug fitting and light combinations, stop light
54g	Trailer signals, compressed air valve for permanent brake in the trailer, electromagnetic actuation
55	Fog lights
56	Headlight
56a	Headlight, spotlight and spotlight control
56b	Headlight, low beam
56d	Headlight, flashing lights
57	Parking light for motorbikes (outside Germany also for cars and trucks)
57a	Parking light
57L	Parking light left
57R	Parking light right
58	Position light, tail light, licence plate lighting and instrument lighting
58b	Tail light switchover for single-axle tractors
58c	Trailer plug fitting for tail light laid with a single wire and fused in the trailer
58d	Adjustable instrument lighting, tail light and position light
58L	Position light left
58R	Position light right

















Contents fog lights and driving lights	1.02-1.03
Contents headlights and work lights series	1.04
Contents work lights	1.05-1.07
Information on LED-technology headlights and work lights	1.08-1.09
Fog lights and driving lights	1.10-1.34
Accessories for fog- and driving lights	1.35
Built-in headlights	1.36-1.68
Accessories for 50 mm, 90 mm and 100 mm dia. built-in headlights	1.55
External fitting headlights	1.69-1.82
Work lights	1.108-1.185
Accessories for work lights and searchlights	1.186-1.190
Searchlights	1.185, 1.191-1.192

**HELLA
VALUEFIT**

Work lights	1.193-1.194
--------------------	--------------------

Fog lights and driving lights













	Module 70 LED	1.10
	DynaView Evo 2	1.10
	Comet 200	1.11-1.12
	Classic 160	1.12
	Comet 500	1.13-1.14
	Luminator Compact	1.15-1.17
	Luminator X	1.18
	Rallye 1000	1.19
	Rallye 3000	1.20-1.21
	Rallye 3003	1.22-1.23
	Luminator	1.24-1.28
	FF 40	1.28
	FF 50	1.29
	FF 75	1.29







Fog lights and driving lights



















1













	Comet FF 100, FF 300	1.29-1.30
	Micro-FF	1.30
	Comet 450	1.31
	Comet FF 450	1.31
	181 Chrom	1.32
	Comet 550	1.32
	Comet FF 550	1.33
	Jumbo 210	1.33
	Jumbo 220	1.34
	Jumbo 320	1.35
	LED Light Bar	1.35













Head- and work light series



	5760	1.83-1.85
	Oval 100	1.85-1.100
	Oval 120	1.100-1.101
	Module 6213	1.102-1.106
	7145	1.107

		5760	1.83-1.85
		Oval 90	1.115-1.116
		Oval 100	1.85-1.100
		Oval 120	1.101
		Module 6213	1.102-1.106
		7145	1.107
		Double-Beam	1.108-1.109
		Master 5060	1.110
		Picador	1.111-1.113
		Flatbeam	1.113
		Torero 5700	1.114
		3590	1.114
		ETL 250	1.115

	ECO 21	1.116
	AS 200	1.117-1.121, 1.185
	AS 300	1.122
	AS 400	1.123
	Ultra Beam	1.124-1.139
	Power Xen	1.140
	Q90 LED	1.141
	Power Beam	1.142-1.149
	AP 700 - 1800 LED	1.150-1.151
	Flat Beam	1.152
	Mega Beam	1.153-1.160
	Micro DE	1.161

	Module 50 LED	1.162
	Module 70	1.163-1.173
	Module 90	1.174-1.176
	Proflex-Gladiator	1.177
	W131	1.178-1.179
	Matador	1.180
	Torro II	1.181
	7033	1.181
		1.182
		1.183
	HypaLUME	1.184
		1.185

Information for headlights with protection caps



Protective caps are not allowed by law in some countries.
Please check with the appropriate authorities before use on public roads.
Under German law (StVZO), headlights must be ready for operation at all times when driving on public roads.
Violation of this regulation is an offence.
The correct function of these lamp failure checks can only be determined by the vehicle manufacturer.

Information for LED headlights



In connection with these low power ratings, which differ significantly from those of a bulb-based version, problems arise with indicator failure control on various traction vehicles, because further light functions are detected by some traction vehicles. This is a comfort function of the vehicle which is not required by law and does not release the driver from its duty to visually check the lighting system. The failure control of an LED headlight demanded by law within the scope of ECE R48 has to be ensured in the vehicle by suitable measures. The customer is responsible for this. Here as well, faulty diagnosis may occur due to the small power (instrument panel in the driver's cab shows lamp failure although function is OK).
The functional ability of these light failure checks can only be established by the vehicle manufacturer.

Operation of the LED headlight with alternating voltage or clocked direct voltage is not permitted!
The individual functions of a headlight must only be operated with an onboard fuse of max. 10A (vehicle-specific 5A).
In the case of onboard current limitation with the values specified above by the onboard control unit an additional fuse for the headlight is not required.

Informations for work lights

Working at night – no problem with the right headlights

Special headlight types have been developed for this purpose:
 Low-beam headlights and spotlights:
 for illuminating the road in road traffic.
 Fog lights:
 for poor visibility conditions in road traffic.
 Work lights:
 for the illumination of a working area near the vehicle and away from public road traffic.

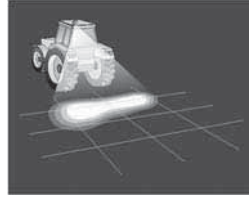

Dipped beam

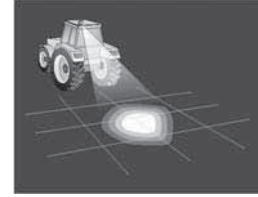

Main beam

At the mounting height typical for work lighting (2.50 m), only worklights provide sufficient illumination of the working area. Standard vehicle lighting is nowhere near good enough!
 Outstanding features of a good worklight include the homogeneous illumination of as large an area as possible and a soft transition at the edge.

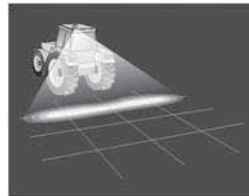

Fog light

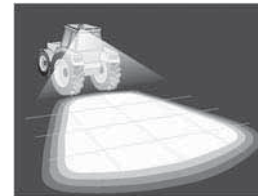

Work light

Active safety through proper illumination!

It's not only the selection of the correct type of headlight that is decisive for the choice of optimum worklight, but its correct positioning on the vehicle, too. Worklights shine at an angle to the surface they are illuminating. This means that even small changes in the angle of inclination and the mounting height have a great influence on the illumination of the working area. For large-surface illumination, the higher the mounting position the better.

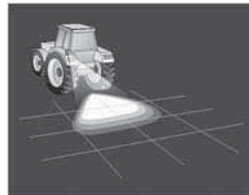

low mounting position

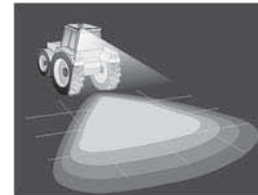

high mounting position

Legal notes:

According to FMVSS § 52 (7) [Germany], all multi-track vehicles may be equipped with one or more worklights. Worklights must not be used when these vehicles are being driven on public roads, only when they are at a standstill, e.g. during loading and unloading.
 Exceptions to this are made for vehicles used for constructing, maintaining or cleaning the roads or for waste disposal vehicles, if the action of driving is part of a working process.
 Worklights may only be switched on as long as they do not dazzle other road users.
 Worklights must be able to be switched on independently of all other headlights or lights, e.g. joint circuitry with the reverse light is not permitted. HELLA provides special reversing spotlights for this purpose.
 There are no special approval regulations, e.g. according to ECE or EC, since worklights may only be used when driving away from public roads.

For upright or pendant mounting

Modul 70 LED

Approved for motorcycles and tractors.

Black finish aluminium body
 Lens with clear-glass look.
 With 2000 mm long lead with stripped ends.
 Voltage range: 12V - 24V.

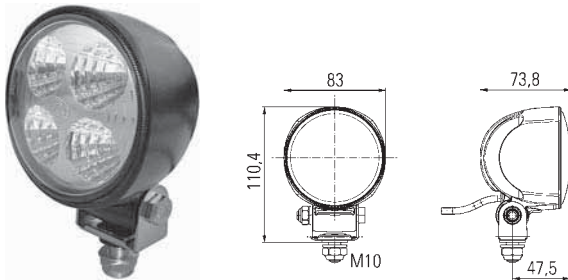

Part no.	Pk.	
1F0 996 376-181	1	LED driving light

For surface/flush mounting

DynaView Evo 2

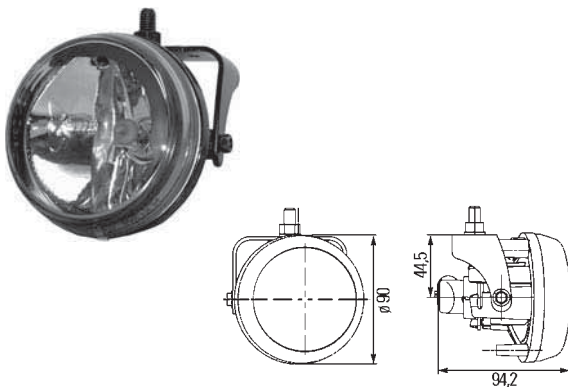

Part no.	Pk.	
1N0 009 295-801	1	H7 fog-/tracking light set with bracket for surface mounting, 12V bulbs and tracking light unit
5DF 009 244-007	24	Spare parts: Tracking light unit
8KB 163 160-801	1	Lead set to the electric connection of the tracking light unit
8KA 202 117-001	1	Adapter lead from 2-pole plug connector of the headlamp to 4-pole FEP plug
8GH 007 157-121	1	H7 bulb, 12V55W
1N0 009 295-011	1	H7-fog-/tracking light with bracket for surface mounting and 12V bulb, left
1N0 009 295-021	1	right
1N0 009 295-031	1	H7 fog-/tracking light with supporting frame for flush mounting and 12V bulb, left
1N0 009 295-037	36	
1N0 009 295-041	1	right
1N0 009 295-047	36	
1N0 009 295-057	36	H7 fog-/tracking light with supporting frame for flush mounting and 24V bulb, left
1N0 009 295-067	36	right
5DF 009 244-007	24	Spare parts/Accessories: Tracking light unit
8KB 163 160-801	1	Lead set to the electric connection of the tracking light unit
8KA 202 117-011	1	Adapter lead from 2-pole plug connector of the headlamp to 4-pole FEP plug
8GH 007 157-121	1	H7 bulb, 12V55W
8GH 007 157-241	1	24V70W

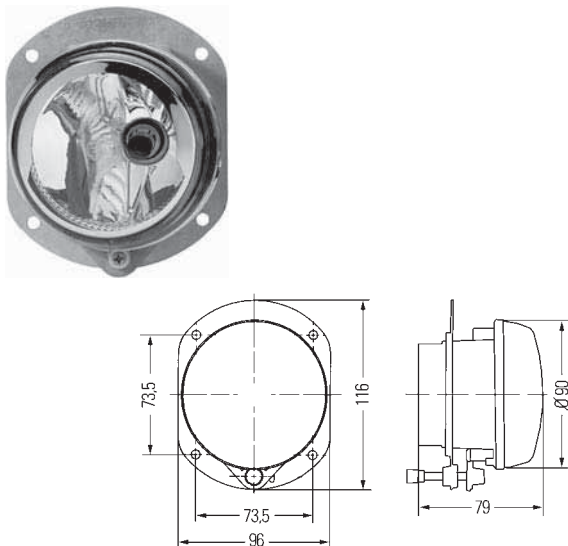

For upright mounting

Comet FF 200

Ref. 37.5: 1F4 007 893-811/-841/-021/-081/-191

Ref. 17.5: 1F4 007 893-921/-911/-201/-241

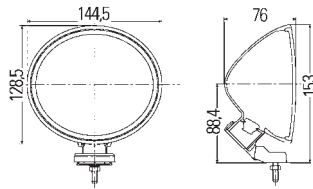

Part no.	Pk.	Description
1N4 007 893-821	1	H3 fog light set with 12V bulbs, relay, lead set, on/off switch, with basalt grey body
1N4 007 893-001	1	H3 fog light with 12V bulb and ivory body
<hr/>		
Ref. 37,5		
1F4 007 893-811	1	H3 driving light set with 12V bulbs, relay with lead set and on/off switch, with ivory body
1F4 007 893-841	1	H3 driving light set with 12V bulbs, relay, lead set, on/off switch, with basalt grey body
1F4 007 893-021	1	H3 driving light with 12V bulb, with ivory body
1F4 007 893-081	1	with basalt grey body
<hr/>		
Ref. 17,5		
1F4 007 893-921	1	H3 driving light set with 12V bulbs, relay with lead set and on/off switch, with ivory body
1F4 007 893-911	1	H3 driving light set with 12V bulbs, relay, lead set and on/off switch, with basalt grey body
1F4 007 893-201	1	H3 driving light without 12V bulb, with chrome-plated body
1F4 007 893-241	1	with blue lens and basalt grey body
Spare parts/Accessories:		
1N4 149 531-011	1	Light unit with 12V bulb, for -821/-001
1F4 149 537-011	1	for -811/-841/-021/-081
1F4 160 302-011	1	for -201
4RA 965 400-001	1	Normally-open relay for -811/-821/-841/-921/-911
6EH 007 946-001	1	Switch for -811/-821/-841/-921/-911
8GH 002 090-133	1	H3 bulb, 12V55W

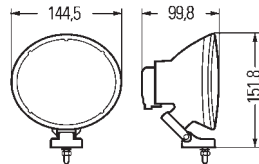

For upright mounting

Comet 200 Xenon

With anthracite body, silver coloured rim.

Part no.	Pk.	
1F4 007 893-871	1	Xenon driving light set with gas discharge bulbs, 12V ballast unit, lead set and relay
1F4 007 893-141	1	Xenon driving light, with gas discharge bulb, 12V ballast unit, lead set and relay
Spare parts/Accessories:		
1F4 157 022-011	1	Light unit
5DV 007 760-631	1	Ballast unit, 12V
8GS 007 949-261	1	D2S gas discharge bulb, 35W

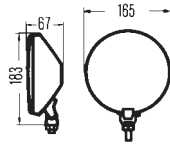

Classic 160

Chrome-plated body.

Part no.	Pk.	
1N4 002 608-021	1	H3 fog light, 12V
1F4 002 608-001	1	H3 driving light, 12V
Accessories:		
8GH 002 090-133	1	H3 bulb, 12V55W

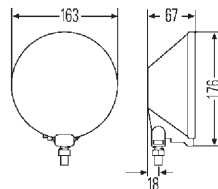

Comet 500

Black plastic body.

Part no.	Pk.	
1N4 005 750-801	1	H3 fog light set with 12V bulbs, relay with lead and on/off switch
1N4 005 750-601	1	H3 fog light, 12V/24V, without bulb
1N4 005 750-041	1	with 12V bulb, amber light
Ref. 37.5		
1F4 005 750-811	1	H3 driving light set with 12V bulbs
1F4 005 750-101	1	H3 driving light with 12V bulb and protection cap
1F4 005 750-611	1	H3 driving light without bulb, without protective cap
Ref. 17.5		
1F4 005 750-871	1	H3 driving light set with 12V bulbs
1F4 005 750-071	1	H3 driving light, 12V/24V, without bulb
Spare parts/Accessories:		
1N4 135 224-011	1	Light unit for -801
1F4 135 230-011	1	Light unit for -811
6EG 001 567-041	1	On/off switch for -801
8GH 002 090-133	1	H3 bulb, 12V55W
8GH 002 090-251	1	H3 bulb, 24V70W

For upright mounting

Comet FF 500

Black plastic body.
Lens with clear-glass look.

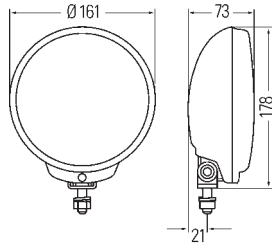

Part no.	Pk.	
1N6 010 952-811	1	H3 fog light set with 12V bulbs, relay with lead and on/off switch, without protection caps
1N6 010 952-101	1	H3 fog light 12V/24V, without bulb, without protection cap
1N6 010 952-111	1	with 12V bulb and protection cap
1F6 010 952-801	1	H3 driving light set with 12V bulbs and relay with lead set, without protection caps
1F6 010 952-821	1	with protection caps
1F6 010 952-001	1	H3 driving light 12V/24V, without bulb, without protection cap
1F6 010 952-011	1	with 12V bulb and protection cap
Spare parts/Accessories:		
1N6 010 952-101	1	Light unit for -811/-101/-111
1F6 010 952-001	1	for -801/-001/-011
8XS 186 531-012	4	Protection cap
8GH 002 090-133	1	H3 bulb, 12V55W
8GH 002 090-251	1	24V70W

For upright mounting

Luminator Compact Celis

Die-cast zinc body, rim and bracket.
Lens with clear-glass look.

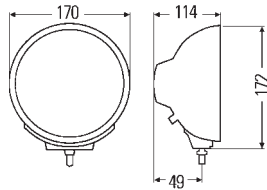

Part no.	Pk.	
1F1 009 094-041	1	Ref. 37.5 H1 main light, 12V/24V, with CELIS position light incl. LEDs, without bulb, black lacquered
1F1 009 094-051	1	Ref. 37,5 H1 driving light, 12V/24V, with CELIS position light incl. LEDs, without bulb, chrome-plated
1F1 009 094-091	1	Ref. 17.5 H1 driving light, 12V/24V, with CELIS position light incl. LEDs, without bulb, chrome-plated
Spare parts/Accessories:		
1F1 161 825-021	1	Light unit for -041/-051
1F1 161 825-041	1	for -091
9AG 161 844-011	1	Lens-retaining rim, black
9AG 161 844-021	1	chrome-plated
8XS 165 048-001	1	Protection cap
8GH 002 089-133	1	H1 bulb, 12V55W
8GH 002 089-251	1	24V70W

For upright mounting

Luminator Compact

Die-cast zinc body, rim and bracket.
Lens with clear-glass look.

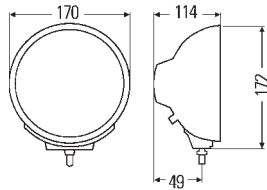

Part no.	Pk.	
1F3 009 094-021	1	Ref. 37.5 H1 driving light, 12V/24V, black lacquered
1F3 009 094-061	1	Ref. 17.5 H1 driving light, 12V/24V, black lacquered
1F3 009 094-031	1	Ref. 37.5 H1 driving light, 12V/24V, chrome plated
1F3 009 094-171	1	H1 driving light, 12V/24V, with blue lens, chrome plated
1F3 009 094-071	1	Ref. 17.5 H1 driving light, 12V/24V, chrome plated
Spare parts/Accessories:		
1F3 161 825-011	1	Light unit for -021/-031
1F3 161 825-031	1	for -061/-071
1F3 161 825-081	1	for -171
9AG 161 844-011	1	Lens-retaining rim, black
9AG 161 844-021	1	chrome-plated
8XS 165 048-001	1	Protection cap
8GH 007 157-121	1	H7 bulb, 12V/55W
8GH 007 157-241	1	24V/70W H1 bulb,
8GH 002 089-133	1	12V/55W
8GH 002 089-251	1	24V/70W

For upright mounting

Luminator Compact Xenon

Die-cast zinc body and bracket, black.
Lens with clear-glass look.

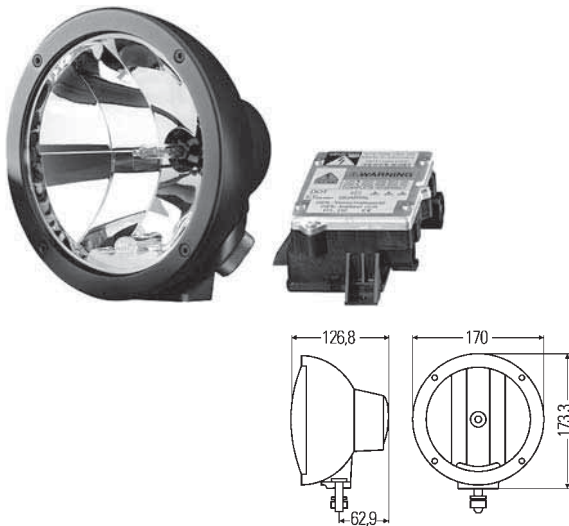

Part no.	Pk.	
1F3 009 094-142	1	Xenon driving light with black rim, gas discharge bulb and 12V ballast unit
1F3 009 094-311	1	Xenon driving light with chrome-plated rim, gas discharge bulb and 12V ballast unit integrated into body
1F3 161 825-071	1	Spare parts: Light unit
9AG 161 844-011	1	Lens-retaining rim, black
9AG 161 844-031	1	chrome-plated
8GS 009 028-111	1	D1S gas discharge bulb, 35W
8XS 165 048-001	1	Protection cap for -142
8XS 165 048-011	1	for -011

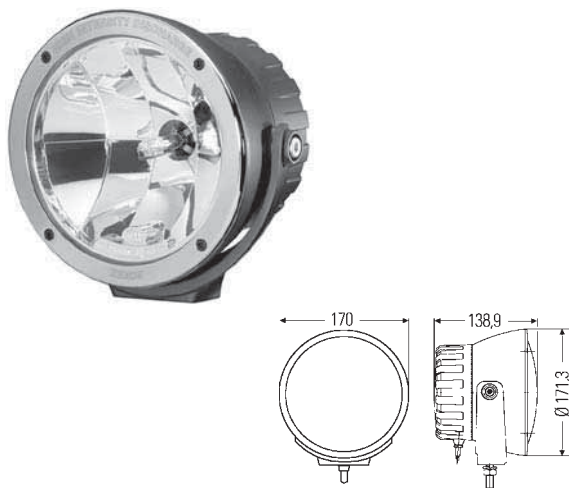

For upright or pendant mounting

Luminator Compact LED

Black die-cast aluminium body and bracket.
Lens with clear-glass look.
With 3000 mm long connection lead.
Voltage range: 12V - 24V, 11W.

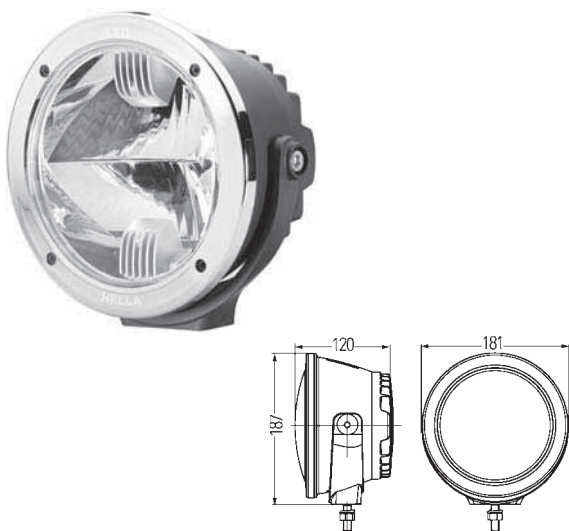

Part no.	Pk.	
1F3 011 815-001	1	LED driving light with chrome-plated lens-retaining rim
1F3 011 815-011	1	with matt black lens-retaining rim
1F3 011 815-031	1	with ventilation hose for Heavy Duty Off Road and matt black lens-retaining rim
9AG 195 614-001	1	Accessories: Chrome plated lens-retaining rim, with clear glass, 4 fixing screws and gasket, for -001
9AG 195 614-011	1	Black lens-retaining rim, with clear glass, 4 fixing screws and gasket, for -011/-031
8XS 199 170-011	1	Protection cap

For upright or pendant mounting

Luminator X LED

Black finish metal body.
Silver finish bracket.
With clear-glass look and 3000 mm long connection lead.
Voltage range: 12V - 24V.

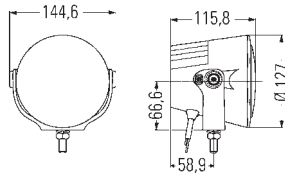

Part no.	Pk.	
1F0 012 206-001	1	LED driving light with chrome-plated lens-retaining rim
1F0 012 206-011	1	with black lens-retaining rim
1F0 012 206-112	1	with grey cover lens and black lens-retaining rim
Spare parts:		
9ES 199 813-001	1	Cover lens for -001/-011
9AG 199 812-001	1	Lens-retaining rim, chrome-plated
9AG 199 812-011	1	black

For upright mounting

Rallye 1000 Xenon

Black/red body. Lens with clear-glass look.

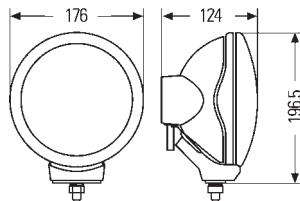

Part no.	Pk.	
1F5 008 273-041	1	Xenon driving light with gas discharge bulb and 12V ballast unit
Spare parts:		
1F5 154 875-011	1	Light unit
5DV 007 760-631	1	Ballast unit
8GS 007 949-261	1	D2S gas discharge bulb, 35W

Rallye 1000

Black plastic body and lens-retaining rim.
With black lens (Colour-Design), without bulb.

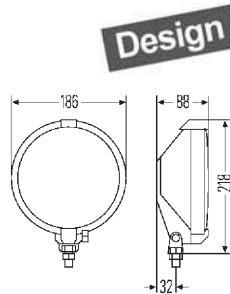

Part no.	Pk.	
1F7 004 700-431	1	H2 driving light, 12V

For upright mounting

Rallye 3000

Black plastic body.

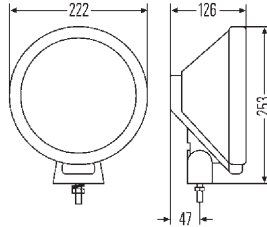

Part no.	Pk.	
1N8 006 800-001	1	H3 fog light, 12V/24V
1F8 006 800-191	1	Ref. 37.5 H1 driving light, 12V/24V, lens with optical pattern, with position light
1F8 006 800-301	1	lens with clear-glass look, without position light
1F8 006 800-311	1	with clear-glass look and position light
1F8 006 800-361	1	Ref. 17.5 H1 driving light, 12V/24V, lens with clear-glass look, without position light
1F8 006 800-341	1	with clear-glass look and position light
1F8 006 800-401	1	with lens with clear-glass look and CELIS position light incl. LEDs
Spare parts/Accessories:		
1F8 147 077-011	1	Light unit for -191
1F8 162 872-011	1	for -301
1F8 162 873-011	1	for -311
1F8 165 941-011	1	for -341
1F8 165 943-011	1	for -361
1F8 161 326-011	1	for -401
9AG 141 819-001	6	Lens-retaining rim for -191
9AG 141 819-041	1	for -301/-311/-341/-361
9AG 162 938-001	1	for -401
8HG 116 741-801	1	Bracket for two-point fixing (2 pcs.)
8KA 002 309-811	1	Lead set
8KB 161 334-007	5	Lead set with LED control electronics for -401
8GH 002 090-133	1	H3 bulb, 12V55W
8GH 002 090-251	1	24V70W H1 bulb, 12V55W
8GH 002 089-133	1	24V70W
8GH 002 089-251	1	W5W bulb, 12V5W
8GP 003 594-121	10	24V5W
8GP 003 594-251	10	24V5W

For upright mounting

Rallye 3000 Blue

Black plastic body,
silver lens-retaining rim with blue stripes.
With blue lens.

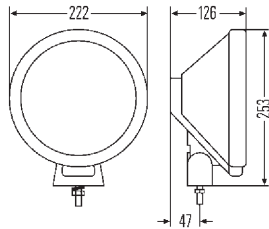
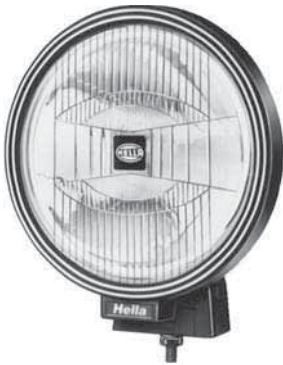

Part no.	Pk.	
1F8 006 800-221	1	Ref. 37.5 H1 driving light, 12V/24V, lens with optical pattern, with position light
1F8 006 800-321	1	lens with clear-glass look, with position light
1F8 006 800-331	1	Ref. 17.5 H1 driving light, 12V/24V, lens with clear-glass look, without position light
1F8 006 800-351	1	lens with clear-glass look, with position light
Spare parts/Accessories:		
1F8 157 042-011	1	Light unit for -221
1F8 162 874-011	1	for -321
1F8 165 940-011	1	for -331
1F8 165 942-011	1	for -351
9AG 141 819-011	6	Lens-retaining rim
8HG 116 741-801	1	Bracket for two-point fixing (2 pcs.)
8KA 002 309-811	1	Lead set
8GH 002 089-133	1	H1 bulb, 12V55W
8GH 002 089-251	1	24V70W W5W bulb,
8GP 003 594-121	10	12V5W
8GP 003 594-251	10	24V5W

For upright mounting

Rallye 3003

Black body.

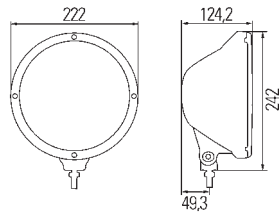

Part no.	Pk.	
1F8 009 797-321	1	Ref. 50 H1 driving light, 12V/24V, with clear-glass look and position light, silver lens-retaining rim
1F8 009 797-341	1	chrome-plated rim
1F8 009 797-331	1	Ref. 50 H1 driving light, 12V/24V, blue lens with clear-glass look, with position light, silver lens-retaining rim
1F8 009 797-351	1	chrome-plated rim
1F8 009 797-021	1	Ref. 37.5 H1 driving light, 12V/24V, with clear-glass look and position light, silver lens-retaining rim
1F8 009 797-101	1	chrome-plated rim
1F8 009 797-031	1	Ref. 37.5 H1 driving light, 12V/24V, blue lens with clear-glass look, with position light, silver lens-retaining rim
1F8 009 797-111	1	chrome-plated rim
1F8 009 797-421	1	Ref. 25 H1 driving light, 12V/24V, lens with clear-glass look, with position light in LED-technology, silver lens-retaining rim
1F8 009 797-431	1	chrome-plated rim
1F8 009 797-121	1	Ref. 17.5 H1 driving light, 12V/24V, silver lens-retaining rim with clear-glass look and position light
1F8 009 797-131	1	blue lens with clear-glass look, with position light
1F8 009 797-451	1	Ref. 17,5 H1 driving light, 12V/24V, lens with clear-glass look, with LED position light incl. LEDs and 450 mm long lead with 6.3 mm blade terminals, silver lens-retaining rim
Spare parts/Accessories:		
Light unit		
1F8 162 870-031	1	for -321/-341
1F8 162 871-021	1	for -331/-351
1F8 162 870-011	1	for -021/-101
1F8 162 871-011	1	for -031/-111
1F8 165 947-011	1	for -121
1F8 165 946-011	1	for -131
1F8 161 326-011	1	for -451
9DS 180 786-011	1	for -421/-431
Lens-retaining rim		
9AG 168 666-001	2	silver coloured
9AG 168 666-011	1	chrome-plated
H1 bulb,		
8GH 002 089-133	1	12V55W
8GH 002 089-251	1	24V70W
W5W bulb,		
8GP 003 594-121	10	12V5W
8GP 003 594-251	10	24V5W

For upright mounting

Rallye 3003 Compact

Black body, silver lens-retaining rim.

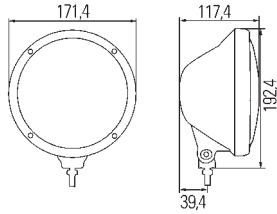

Part no.	Pk.	
1F3 010 119-011	1	Ref. 37.5 H1 driving light, 12V/24V, lens with clear-glass look
1F3 010 119-111	1	lens with clear-glass look, chrome-plated rim
1F3 010 119-021	1	lens with blue, clear-glass look, silver rim
1F3 010 119-121	1	lens with blue, clear-glass look, chrome-plated rim
<hr/>		
1F3 010 119-001	1	Ref. 17.5 H1 driving light, 12V/24V, lens with clear-glass look
1F3 010 119-101	1	lens with clear-glass look, chrome-plated rim
Spare parts/Accessories:		
Light unit		
1F3 161 825-011	1	for -011
1F3 161 825-081	1	for -021
1F3 161 825-031	1	for -001
H1 bulb,		
8GH 002 089-133	1	12V55W
8GH 002 089-251	1	24V70W

For upright mounting

Luminator-Metal

Black die-cast cinc body and lens-retaining rim.

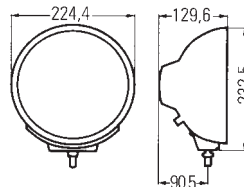

Part no.	Pk.	
1N8 007 560-031	1	H3 fog light, 12V/24V
1F8 007 560-401	1	Ref. 50 H1 driving light, 12V/24V, with clear-glass look and position light
1F8 007 560-301	1	Ref. 37.5 H1 driving light, 12V/24V, with clear-glass look and position light
1F8 007 560-041	1	lens with clear-glass look, with position light
1F8 007 560-011	1	Ref. 17.5 H1 driving light, 12V/24V, lens with clear-glass look, with position light
		Spare parts/Accessories:
		Light unit
1N8 148 103-011	1	for -031
1F8 162 870-031	1	for -401
1F8 148 131-011	1	for -041
1F8 162 870-011	1	for -301
1F8 148 009-011	1	for -011
9AG 147 939-011	1	Lens-retaining rim
8HG 116 741-801	1	Bracket for two-point fixing (2 pcs.)
8GH 002 090-133	1	H3 bulb, 12V55W
8GH 002 090-251	1	24V70W H1 bulb, 12V55W
8GH 002 089-133	1	12V55W
8GH 002 089-251	1	24V70W W5W bulb,
8GP 003 594-121	10	12V5W
8GP 003 594-251	10	24V5W

For upright mounting

Luminator-Metal CELIS

Black die-cast cinc body and lens-retaining rim.

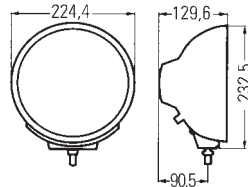

Part no.	Pk.	
1F8 007 560-201	1	H1 driving light, 12V24V, with clear-glass look and position light in CELIS technology incl. LEDs
Spare parts/Accessories:		
1F8 161 326-011	1	Light unit
9AG 147 939-011	1	Lens-retaining rim
8KB 161 334-007	5	Lead set with LED control electronics
8GH 002 089-133	1	H1 bulb, 12V55W
8GH 002 089-251	1	24V70W

Luminator Chromium CELIS

Chrome-plated die-cast cinc body and lens-retaining rim.

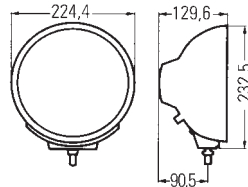

Part no.	Pk.	
1F8 007 560-211	1	H1 driving light, 12V24V, with clear-glass look and position light in CELIS technology incl. LEDs
Spare parts/Accessories:		
1F8 161 326-011	1	Light unit
8KB 161 334-007	5	Lead set with LED control electronics
8GH 002 089-133	1	H1 bulb, 12V55W
8GH 002 089-251	1	24V70W

For upright mounting

Luminator-Chromium

Chrome-plated die-cast cinc body and lens-retaining rim.

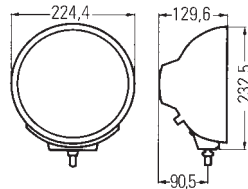

Part no.	Pk.	
1N8 007 560-021	1	H3 fog light, 12V/24V
		Ref. 50 H1 driving light, 12V/24V, with position light and lens with clear-glass look
1F8 007 560-411	1	
		with position light and blue lens with clear-glass look
1F8 007 560-421	1	
		Ref. 37.5 H1 driving light, 12V/24V, with position light and patterned cover lens
1F8 007 560-051	1	
		with position light and lens with clear-glass look
1F8 007 560-311	1	
		with position light and blue, patterned cover lens
1F8 007 560-131	1	
		with position light and blue lens with clear-glass look
1F8 007 560-321	1	
		Ref. 25 H1 driving light, 12V/24V, with position light in LED-technology and lens with clear-glass look
1F8 007 560-451	1	
		Ref. 17.5 H1 driving light, 12V/24V, with position light and lens with clear-glass look
1F8 007 560-341	1	
		with position light and blue lens with clear-glass look
1F8 007 560-331	1	
		Spare parts/Accessories:
		Light unit
1N8 148 103-011	1	for -021
1F8 162 870-031	1	for -411
1F8 162 871-021	1	for -421
1F8 148 131-011	1	for -051
1F8 162 870-011	1	for -311
1F8 158 926-011	1	for -131
1F8 162 871-011	1	for -321
9DS 180 786-011	1	for -451
1F8 165 946-011	1	for -331
1F8 165 947-011	1	for -341
9AG 147 939-021	1	Lens-retaining rim
8HG 116 741-801	1	Bracket for two-point fixing (2 pcs.)
		H3 bulb,
8GH 002 090-133	1	12V55W
8GH 002 090-251	1	24V70W
		H1 bulb,
8GH 002 089-133	1	12V55W
8GH 002 089-251	1	24V70W
		W5W bulb,
8GP 003 594-121	10	12V5W
8GP 003 594-251	10	24V5W

For upright mounting

Luminator Xenon

Red/black body, red lens-retaining rim and bracket made of die-cast cinc.

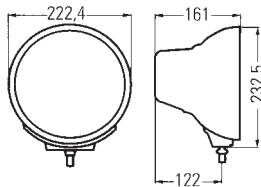

Part no.	Pk.	
1F8 007 560-561	1	Xenon driving light with gas discharge bulb and 12V ballast unit
1F8 007 560-571	1	and 24V ballast unit
Spare parts/Accessories:		
1F8 149 644-011	1	Light unit
9AG 147 939-031	1	Lens-retaining rim
5DV 007 760-631	1	Ballast unit, 12V
5DV 007 810-171	1	24V
8HG 116 741-801	1	Bracket for two-point fixing (2 pcs.)
8XS 147 945-001	1	Protection cap
8GS 007 949-261	1	D2S gas discharge bulb, 35W

Black body, red lens-retaining rim and bracket made of die-cast cinc. Lens with clear-glass look.

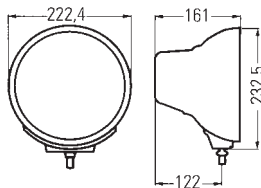

Part no.	Pk.	
1F8 007 560-621	1	Xenon driving light with gas discharge bulb and 12V ballast unit
1F8 007 560-631	1	and 24V ballast unit
Spare parts/Accessories:		
1F8 165 949-011	1	Light unit for -621
1F8 165 951-011	1	for -631
9AG 147 939-031	1	Lens-retaining rim
5DV 008 855-001	1	Ballast unit, 12V
5DV 008 856-001	1	24V
8HG 116 741-801	1	Bracket for two-point fixing (2 pcs.)
8XS 147 945-001	1	Protection cap
8GS 009 028-111	1	D1S gas discharge bulb, 35W

Black body and bracket made of die-cast cinc. Chrome-plated rim. Lens with clear-glass look

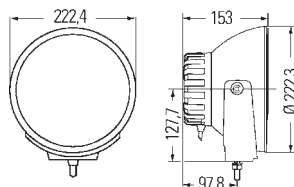

Part no.	Pk.	
1F8 007 560-721	1	Xenon driving light with gas discharge bulb and 12V ballast unit integrated into body
1F8 007 560-731	1	and 24V ballast unit integrated into body
Spare parts/Accessories:		
1F8 173 055-021	1	Light unit
9AG 147 939-061	1	Lens-retaining rim
8XS 147 945-011	1	Protection cap
5DV 010 286-001	1	Ballast unit, 12V
5DV 010 286-011	1	24V
8XS 147 945-011	1	Protection cap
8GS 009 028-111	1	D1S gas discharge bulb, 35W

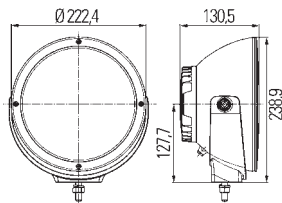

For upright mounting

Luminator LED

Black die-cast aluminium body and bracket, chrome-plated lens-retaining rim.

Part no.	Pk.	
1F8 011 002-001	1	LED driving light, 12V/24V, with clear-glass look and LED position light incl. LEDs, Ref. 40
1F8 011 002-011	1	Ref. 50
Spare parts:		
1F8 181 541-011	1	Light unit for -001
1F8 181 541-031	1	for -011

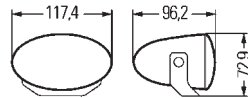

For flush mounting

FF 40

With 12V bulb.

Mounting with supporting frame in the vehicle front. Lens with clear-glass look.

Part no.	Pk.	
1NA 010 047-101	1	H8 fog light
Spare parts:		
8GH 008 356-121	1	H8 bulb, 12V35W

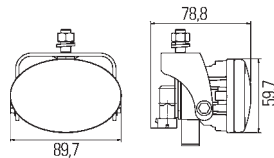

For surface mounting

Part no.	Pk.	
1NA 010 047-811	1	H8 fog light set with brackets, 12V bulbs, relay with lead and accessories
1NA 010 047-111	1	H8 fog light with bracket and 12V bulb
1FA 010 047-801	1	H11 driving light set with brackets, 12V bulbs, relay with lead and accessories
1FA 010 047-011	1	H11 driving light with bracket and 12V bulb
Spare parts:		
8GH 008 356-121	1	H8 bulb, 12V35W
8GH 008 358-121	1	H11 bulb, 12V55W

For upright or pendant mounting

FF 50

Black plastic body. Lens with clear-glass look.

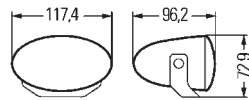

Part no.	Pk.	
1NA 008 283-801	1	H7 fog light set with 12V bulbs, relay, switch and lead set
1NA 008 283-001	1	H7 fog light with 12V bulb
1FA 008 283-811	1	H7 driving light set with 12V bulbs, relay, switch and lead set
1FA 008 283-011	1	H7 driving light with 12V bulb
1FA 008 283-861	1	H7 driving light set with blue lenses, 12V bulbs, relay, switch and lead set
1FA 008 283-031	1	H7 driving light with blue lens and 12V bulb
8GH 007 157-121	1	Spare parts: H7 bulb, 12V55W

FF 75

Black plastic body. Lens with clear-glass look.



Part no.	Pk.	
1NA 008 284-801	1	H7 fog light set with 12V bulbs, relay, switch and lead set
1NA 008 284-001	1	H7 fog light with 12V bulb
1FA 008 284-811	1	H7 driving light set with 12V bulbs, relay, switch and lead set
1FA 008 284-011	1	H7 driving light with 12V bulb
1FA 008 284-861	1	H7 driving light set with blue lenses, 12V bulbs, relay, switch and lead set
1FA 008 284-031	1	H7 driving light with blue lens and 12V bulb
8GH 007 157-121	1	Spare parts: H7 bulb, 12V55W

For upright or pendant mounting

Comet FF 100

Plastic body. Lens with clear-glass look.

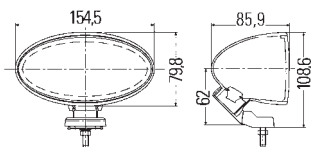

Part no.	Pk.	
1NA 007 891-821	1	H3 fog light set with 12V bulbs, relay with lead set, on/off switch and basalt grey body
1NA 007 891-041	1	H3 fog light with 12V bulb and basalt grey body
1FA 007 891-811	1	H3 driving light set with 12V bulbs, relay with lead set, on/off switch and ivory body
1FA 007 891-841	1	and basalt grey body
1FA 007 891-061	1	H3 driving light with 12V bulb
1FA 149 504-011	1	Spare parts: Light unit with 12V bulb for -811/-841/-061
4RA 965 400-001	1	Normally-open relay for -811/-821/-841
8GH 002 090-133	1	H3 bulb, 12V55W

For upright or pendant mounting

Comet FF 300

Plastic body. Lens with clear-glass look.

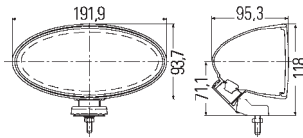

Part no.	Pk.	
1NB 007 892-821	1	H3 fog light set with 12V bulbs, relay with lead set, on/off switch and basalt grey body
1NB 007 892-041	1	H3 fog light with 12V bulb and basalt grey body
1NB 007 892-001	1	and ivory body
1FB 007 892-811	1	H3 driving light set with 12V bulbs, relay with lead set, on/off switch and ivory body
1FB 007 892-841	1	and basalt grey body
1FB 007 892-011	1	H3 driving light with 12V bulb and ivory body
1FB 007 892-071	1	H3 driving light without bulb, with basalt grey body
1FB 007 892-131	1	without bulb, with blue lens with clear-glass look and basalt grey body
1FB 149 519-011	1	Spare parts/Accessories: Light unit with 12V bulb for -811/-841/-011/-071
4RA 965 400-001	1	Normally-open relay for -811/-821/-841
8GH 002 090-133	1	H3 bulb, 12V55W

For upright mounting

Micro-FF

Black plastic body. Lens with clear-glass look.

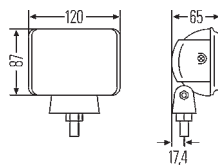

Part no.	Pk.	
1NA 007 133-001	1	H3 fog light, 12V
1FA 007 133-021	1	H3 driving light, 12V
8GH 002 090-133	1	Accessories: H3 bulb, 12V55W

For upright or pendant mounting

Comet 450

Black plastic body.

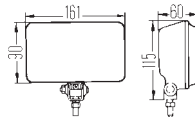

Part no.	Pk.	
1NB 005 860-801	1	H3 fog light set with 12V bulbs, relay with lead set and switch
1NB 005 860-131	1	H3 fog light, 12V, without bulb
1NB 005 860-021	1	with 12V bulb, amber light
1FB 005 860-831	1	H3 driving light set with 12V bulbs and relay with lead set
1FB 005 860-031	1	H3 driving light with 12V bulb
1FB 005 860-061	1	with 12V bulb, amber light
Spare parts/Accessories:		
1NB 137 001-021	2	Light unit, white for -801/131
1FB 137 006-021	2	for -831/-031
8GH 002 090-133	1	H3 bulb, 12V55W

Comet FF 450

Black plastic body.

Lens with clear-glass look.

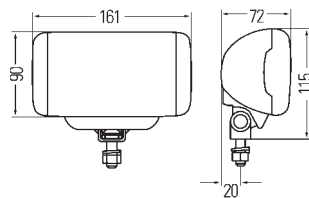

Part no.	Pk.	
1NB 010 951-831	1	H3 fog light set with 12V bulbs, relay with lead set, on/off switch and protection caps
1NB 010 951-101	1	H3 fog light, 12V/24V, without bulb, without protection cap
1NB 010 951-111	1	with 12V bulb and protection cap
Spare parts/Accessories:		
1NB 187 883-101	1	Light unit
8GH 002 090-133	1	H3 bulb, 12V55W
8GH 002 090-251	1	24V70W
1FB 010 951-821	1	H3 driving light set with 12V bulbs, relay with lead set and protection caps
1FB 010 951-001	1	H3 driving light, 12V/24V, without bulb, without protection cap
1FB 010 951-011	1	with 12V bulb and protection cap
Spare parts/Accessories:		
1FB 187 883-001	1	Light unit
8XS 186 532-012	6	Protection cap
8GH 002 090-133	1	H3 bulb, 12V55W
8GH 002 090-251	1	24V70W

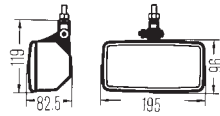
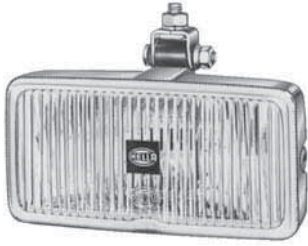

For pendant surface mounting

181 Chrome

Chrome-plated plastic body.

Part no.	Pk.	
1ND 003 590-401	1	H3 fog light, 12V/24V
1FD 003 590-411	1	H3 driving light, 12V/24V
Spare parts/Accessories:		
1FD 135 198-011	1	Light unit for -411
8GH 002 090-133	1	H3 bulb, 12V/55W
8GH 002 090-251	1	H3 bulb, 24V/70W

For upright or pendant mounting

Comet 550

Black plastic body.

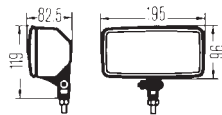

Part no.	Pk.	
1ND 005 700-841	1	H3 fog light set with 12V bulbs, relay with lead set and switch
1ND 005 700-001	1	H3 fog light with 12V bulb
1ND 005 700-061	1	with hardened lens, without bulb, 12V/24V
1ND 005 700-021	1	with 12V bulb, amber light
1FD 005 700-851	1	H3 driving light with 12V bulbs, relay with lead set and switch
1FD 005 700-051	1	without bulb, 12V
1FD 005 700-301	1	with 12V bulb
Spare parts/Accessories:		
1ND 136 933-011	1	Light unit for -061
1FD 135 198-011	1	Light unit for -851/-051
6EG 001 567-041	1	On/off switch for -841
8GH 002 090-133	1	H3 bulb, 12V/55W
8GH 002 090-251	1	H3 bulb, 24V/70W

For upright or pendant mounting

Comet FF 550

Black plastic body.
Lens with clear-glass look.

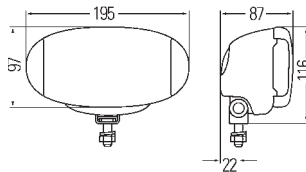

Part no.	Pk.	
1ND 010 953-811	1	H3 fog light set with 12V bulbs, relay with lead set, on/off switch and protective caps
1ND 010 953-101	1	H3 fog light, 12V/24V, without bulb, without protection cap
1ND 010 953-111	1	with 12V bulb and protection cap
1FD 010 953-801	1	H3 driving light set with 12V bulb, relay with lead set and protective caps
1FD 010 953-001	1	H3 driving light, 12V/24V, without bulb, without protection cap
1FD 010 953-011	1	with 12V bulb and protection cap
Spare parts/Accessories:		
1ND 187 888-101	1	Light unit for -811/-101/-111
1FD 187 888-001	1	Light unit for -801/-001/-011
8XS 186 532-012	6	Protection cap
8GH 002 090-133	1	H3 bulb, 12V55W
8GH 002 090-251	1	H3 bulb, 24V70W

Jumbo 210 Chrome

Chrome plated body and lens-retaining rim.

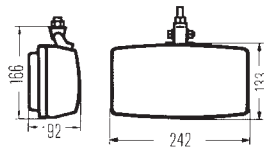

Part no.	Pk.	
1NE 002 537-201	1	H3 fog light, 12V/24V
1FE 002 537-191	1	H3 driving light, 12V/24V
Spare parts/Accessories:		
9DF 112 246-001	1	Reflector with lens and retaining spring for -201
8GH 002 090-133	1	H3 bulb, 12V55W
8GH 002 090-251	1	H3 bulb, 24V70W

For upright or pendant mounting

Jumbo 220

Black plastic body.

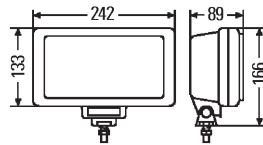

Part no.	Pk.	
1NE 006 300-051	1	H3 fog light, 12V/24V with black lens-retaining rim
1NE 006 300-011	1	with chrome-plated lens-retaining rim
1NE 006 300-101	1	with black lens-retaining rim, amber light
<hr/>		
1FE 006 300-041	1	Ref. 37.5 H3 driving light, 12V/24V, with black lens-retaining rim
1FE 006 300-001	1	with chrome-plated lens-retaining rim
1FE 006 300-261	1	with chrome-plated lens-retaining rim and blue lens
1FE 006 300-081	1	Ref. 17.5 H3 driving light, 12V/24V, with black lens-retaining rim
Spare parts/Accessories:		
		Light unit
1NE 138 555-011	1	for -051/-011
1FE 138 520-011	1	for -041/-001
1FE 158 877-011	1	for -261
9AG 138 131-001	5	Lens-retaining rim, chrome-plated
		H3 bulb,
8GH 002 090-133	1	12V55W
8GH 002 090-251	1	24V70W

For upright or pendant mounting

Jumbo 320 FF

Black plastic body. Lens with clear-glass look.

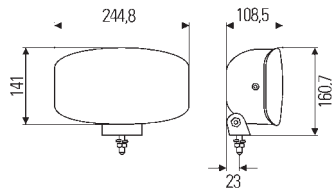

Part no.	Pk.	
1NE 008 773-031	1	H7 fog light, 12V/24V
1FE 008 773-001	1	Ref. 37.5 H7 driving light, 12V/24V, without position light
1FE 008 773-041	1	with position light in bulb technology
1FE 008 773-081	1	with position light in LED technology incl. LEDs
1FE 008 773-061	1	with blue lens with clear-glass look, without position light
1FE 008 773-011	1	Ref. 17.5 H7 driving light, 12V/24V, without position light
Spare parts/Accessories:		
Light unit		
1FE 161 641-011	1	for -001
1FE 161 641-021	1	for -061
1FE 161 642-011	1	for -011
1FE 161 644-011	1	for -041
9DW 196 483-001	1	LED module position light for -081
8GH 007 157-121	1	H7 bulb, 12V55W
8GH 007 157-241	1	24V70W
8GP 003 594-121	10	W5W bulb, 12V5W
8GP 003 594-251	10	24V5W

Jumbo 320 Xenon

Black plastic body. Lens with clear-glass look.

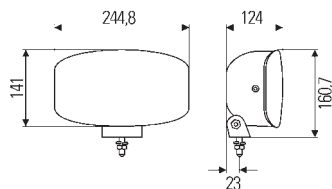

Part no.	Pk.	
1FE 008 773-021	1	Xenon driving light with gas discharge bulb and LED position light incl. LEDs, with 12V ballast unit
1FE 008 773-051	1	with 24V ballast unit
Spare parts/Accessories:		
Light unit		
9DW 196 483-001	1	LED module position light
Ballast unit,		
5DV 008 855-001	1	12V
5DV 008 856-001	1	24V
8GS 007 949-261	1	D2S gas discharge bulb, 35W

LED Light Bar 350 mm

With 12 Power LEDs, 25W, 2500 mm long lead with stripped ends and polarity reversal protection.

PC lens with clear-glass look.

Black plastic body.

2 mounting brackets with variable locking positions.

Voltage range: 12V - 24V.

Type of protection: IP6K7 and IP6K9K.

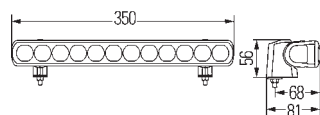

Part no.	Pk.	
1FJ 958 040-001	1	LED driving light, Ref. 20
1FJ 958 040-051	1	Ref. 30

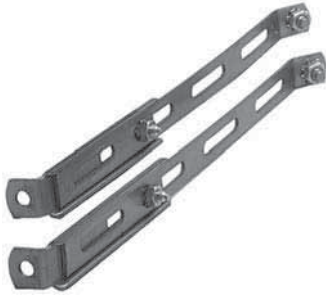

Two-point fixing

Fixing system made of stainless steel which can be shortened, bent or twisted as required.
Length: 80 - 240 mm. Contents: 2 pieces.

Part no.	Pk.	
8HG 116 741-801	1	Two-point fixing



Universal lead set

For 1 to 2 auxiliary lights.
Including relay with 16A fuse, lead and installation material.

Part no.	Pk.	
8KA 002 309-811	1	Universal lead set



Normally-open relay

With bracket and blade-type fuse.

With four 6.3 mm blade terminal contacts.
Max. load (at +80 °C): 15A at 12V and 24V.

Part no.	Pk.	
4RA 003 530-001	1	Normally-open relay, 4-pole, 12V
4RA 003 530-051	1	24V



On-off switches

Rocker switch with green warning light and 12V bulb.

With three 6.3 mm blade terminal contacts.
Max. load: 10A at 12V.

Part no.	Pk.	
6EH 007 946-001	1	On-off switch

Built-in headlights

Micro DE

Ref. 17.5

Light aperture: 40 mm dia.

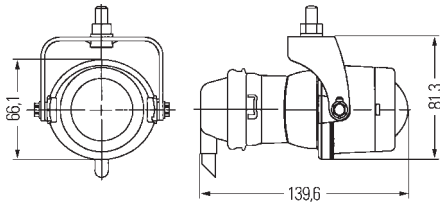

Part no.	Pk.	
1NL 008 090-821	1	DE H3 fog light set with 12V bulbs, black body, cap, alu-ring, designpanels, black brackets and relay with lead set
1NL 008 090-031	1	DE H3 fog light with black ring, cap, holder and screws, with 12V bulb
1NL 008 090-037	60	
1NL 008 090-117	1	with 24V bulb
Spare parts/Accessories:		
9GH 147 009-007	30	Rubber sealing cap
9HD 149 253-007	1	Plastic sealing cap with plug
8JD 156 150-807	1	Delphi socket set, 2-pole (20 pcs.)
6EH 007 946-001	1	On/off switch
		H3 bulb,
8GH 002 090-133	1	12V55W
8GH 002 090-251	1	24V70W

DE-Xenon

Ref. 17.5

Light aperture: 40 mm dia.

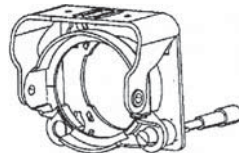
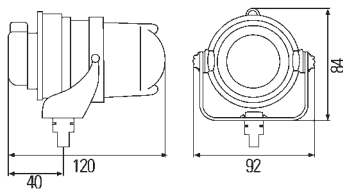
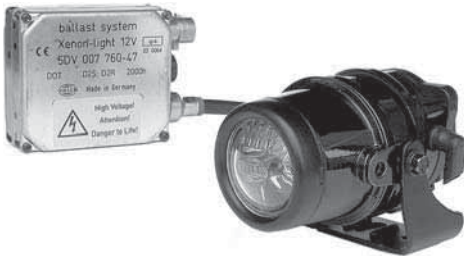

Part no.	Pk.	
1F0 008 390-801	1	DE Xenon driving light set with black decorative rings and brackets, gas discharge bulbs, 12V ballast units and relay with lead set
1F0 008 390-001	1	DE Xenon driving light with black decorative ring and bracket, gas discharge bulb, 12V ballast unit and relay with lead set
Spare parts/Accessories:		
5DV 007 760-631	1	Ballast unit, 12V
6EH 007 946-001	1	On/off switch
8GS 007 949-261	1	D2S gas discharge bulb, 35W
8HG 153 152-001	1	Convenience mount with adjustment screw

Built-in headlights

With H3 light and bulb.
Light aperture: 54 mm dia.

Mounting depth: 105 mm.

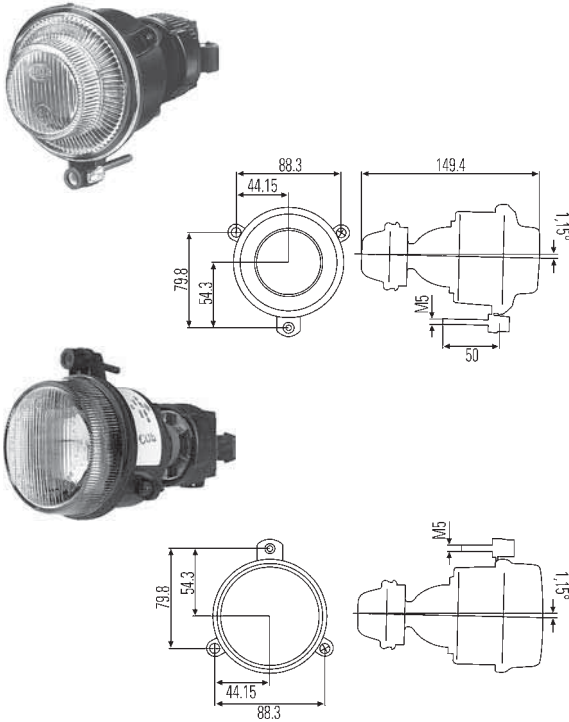

Part no.	Pk.	
1NL 007 186-061	1	DE H3 fog light, 12V, with plastic sealing cap
1NL 007 186-021	1	DE H3 fog light, 12V, without plastic sealing cap
1NL 007 186-027	30	
1NL 007 186-047	1	DE H3 fog light, 24V, plastic sealing cap with cover and lead
Spare parts/Accessories:		
9HD 149 253-007	1	Plastic sealing cap with cover, lead and plug
9GH 147 009-007	30	Rubber sealing cap
8JD 156 150-807	1	Delphi socket set, 2-pole (20 pcs.)
		H3 bulb,
8GH 002 090-133	1	12V55W
8GH 002 090-251	1	24V70W

Premium 50

With H3 light. Light aperture: \varnothing 50 mm dia.

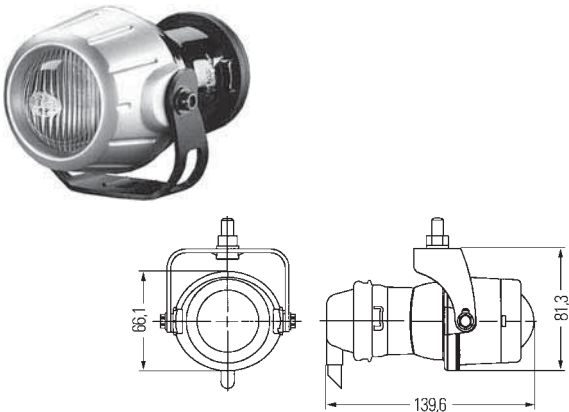

Part no.	Pk.	
1NL 008 090-301	1	DE H3 fog light with 12V bulb, alu-designpanel, black metal body and bracket
Spare parts/Accessories:		
9GH 147 009-007	30	Rubber sealing cap
9HD 149 253-007	1	Plastic sealing cap with plug
8JD 156 150-807	1	Delphi socket set, 2-pole (20 pcs.)
		H3 bulb,
8GH 002 090-133	1	12V55W
8GH 002 090-251	1	24V70W

Built-in headlights

Premium 50 mm

With H3 light. Light aperture: Ø 50 mm dia.

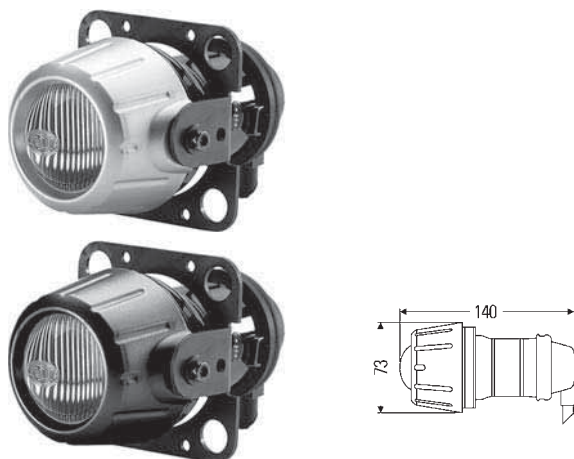

Part no.	Pk.	
1NL 008 090-317	24	DE H3 fog light with 12V bulb and alu-designpanel
1NL 008 090-397	24	with 12V bulb and black designpanel
1NL 008 090-327	24	with 3 attachment elements, 24V bulb and black designpanel
Spare parts/Accessories:		
9AH 161 786-017	12	Supporting frame
9GH 147 009-007	30	Rubber sealing cap
9HD 149 253-007	1	Plastic sealing cap with plug
8JD 156 150-807	1	Delphi socket set, 2-pole (20 pcs.)
		H3 bulb,
8GH 002 090-133	1	12V55W
8GH 002 090-251	1	24V70W

DE-Xenon Premium

Black body and bracket, with alu-ring, designpanel.
Light aperture: 50 mm dia.

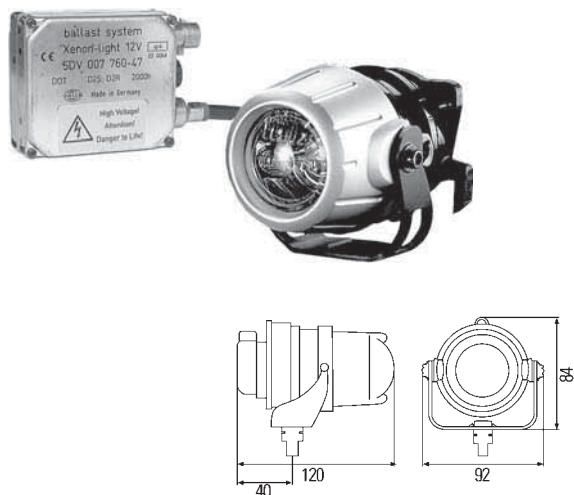

Part no.	Pk.	
1F0 008 390-821	1	DE Xenon driving light set with gas discharge bulbs and 12V ballast units
1F0 008 390-301	1	DE Xenon driving light with gas discharge bulb and 12V ballast unit
Spare parts/Accessories:		
5DV 007 760-631	1	Ballast unit, 12V
8GS 007 949-261	1	D2S gas discharge bulb, 35W
8JD 156 151-807	1	Delphi socket set, 2-pole (20 pcs.)

Premium 50 mm

With gas discharge bulb. Light aperture: 50 mm dia.

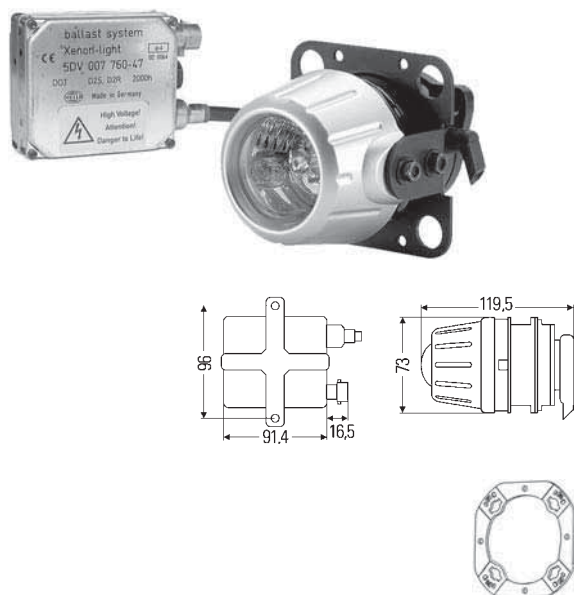

Part no.	Pk.	
1F0 008 390-317	12	DE Xenon driving light with 12V ballast unit
1F0 008 390-327	12	with 3 attachment elements and 24V ballast unit
Spare parts/Accessories:		
		Ballast unit,
5DV 007 760-631	1	12V
5DV 007 810-171	1	24V
8GS 007 949-261	1	D2S gas discharge bulb, 35W
8JD 156 151-807	1	Delphi socket set, 2-pole (20 pcs.)
9AH 161 786-017	12	Supporting frame

Built-in headlights

Premium 50 mm

With H7 light. Light aperture: 50 mm dia.

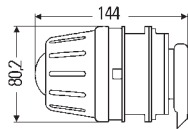
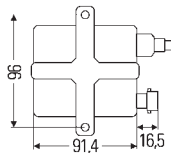
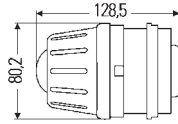

Part no.	Pk.	
1BL 009 071-001	1	DE H7 dipped-beam headlight with 12V bulb and alu-designpanel
1BL 009 071-007	24	
1BL 009 071-107	24	and black designpanel
1BL 009 071-047	12	DE Xenon dipped-beam headlight with gas discharge bulb, alu-designpanel and 12V ballast unit
1BL 009 071-067	12	and 24V ballast unit
Spare parts/Accessories:		
8GH 007 157-121	1	H7 bulb, 12V55W
8GH 007 157-241	1	24V70W
8GS 007 949-261	1	D2S gas discharge bulb, 35W
5DV 007 760-631	1	Ballast unit, 12V
5DV 007 810-171	1	24V
9AH 161 784-017	1	Supporting frame with headlight leveller retainer, for -001/-007/-107/-047
9AH 161 786-017	12	without headlight leveller retainer, for -001/-007/-107/-047/-067
6NM 007 282-221	1	Actuator for headlight levellers, for -001/-007/-107
6NM 007 282-231	1	for -047
8XX 010 315-001	1	Automatic ultrasonic headlight levelling, with 4 m long lead, 12V
8XX 010 315-101	1	with 10 m long lead, 12V
8XX 010 315-011	1	with 4 m long lead, 24V
8JD 156 151-807	1	Delphi socket set, 2-pole (20 pcs.)

Premium 60 mm

With H9 light. Light aperture: 56 mm dia.

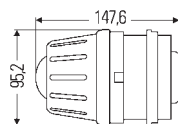

Part no.	Pk.	
1KL 009 486-001	1	DE H9 driving light with 3 attachment elements and 12V bulb
8GH 008 357-001	1	Spare parts: H9 bulb, 12V65W

Built-in headlights

Module 60

With HB3 light. Lens with reflector bonded.
With 12V bulb(s). Light aperture: 60 mm dia.

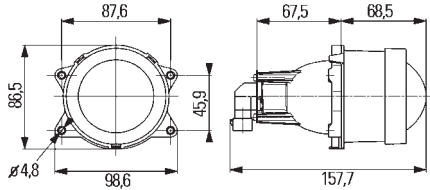
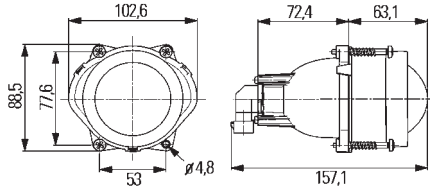
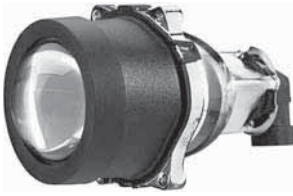

Part no.	Pk.	
1BL 998 570-001	1	DE HB3 dipped-beam headlight without position light
1KL 998 570-021	1	Ref. 12.5 DE HB3 driving light without position light
1KL 998 570-031	1	with position light
Spare parts/Accessories:		
8GH 005 635-121	1	HB3 bulb, 12V65W
8GP 003 594-141	10	W3W bulb, 12V/3W
8JA 990 295-217	10	Plug for HB3 bulb

With H7 light. Light aperture: 90 mm dia.

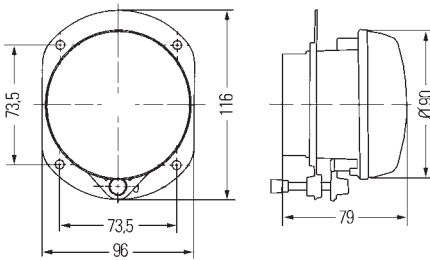

Part no.	Pk.	
1N0 008 582-001	1	H7 fog light with 12V bulb
1N0 008 582-007	24	
1N0 008 582-011	1	with 24V bulb
1N0 008 582-017	24	
1N0 008 582-042	1	with 24V HDLL bulb
1N0 008 582-037	36	without bulb cover, with 24V bulb
Spare parts/Accessories:		
9GH 158 051-007	1	Cap
9XS 124 218-037	500	Clamping piece
8GH 007 157-121	1	H7 bulb, 12V55W
8GH 007 157-241	1	24V70W
8GH 007 157-231	1	24V70W (HDLL)

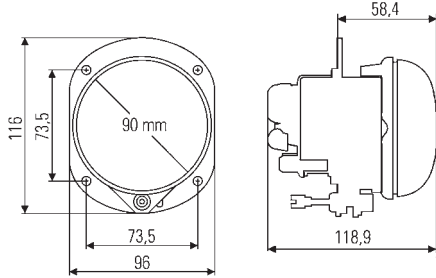

Built-in headlights

With H15 light and daytime running light.
 Light aperture: 90 mm dia.
 For mounting in the front apron or
 in combination with 90 mm dia. headlights.

Part no.	Pk.	
1N0 010 294-001	1	H15 fog light with daytime running light and 12V bulb
1N0 010 294-011	1	and 24V bulb
1F0 010 293-001	1	Ref. 12.5 H15 driving light with daytime running light and 12V bulb
Accessories:		
8GJ 168 119-001	1	H15 bulb, 12V15/55W
8GJ 168 119-241	1	24V20/60W
8JD 162 581-802	1	AMP plug-set, 3-pole (20 pieces)

90 mm Classic

DE H7 dipped-beam headlight.
 Light aperture: 90 mm dia.
 Reflector with lens bonded.

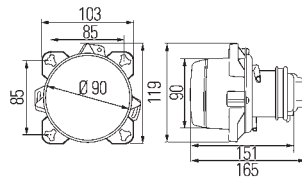

Part no.	Pk.	
1BL 008 193-001	1	DE H7 dipped-beam headlight with 12V bulb
1BL 008 193-007	36	
1BL 008 193-011	1	with 24V bulb
1BL 008 193-017	36	
1BL 008 193-172	1	with 24V HD bulb
Spare parts/Accessories:		
9XB 152 977-001	1	Actuator for headlight levellers (3 pcs.)
9GH 152 654-012	36	Rubber sealing cap for angular plug, without ventilation
9GH 145 943-012	1	for 2-pole socket, without ventilation
9AH 157 659-007	20	Supporting frame
8GH 007 157-121	1	H7 bulb, 12V55W
8GH 007 157-241	1	24V70W
8GH 007 157-231	1	24V70W (HDLL)

Built-in headlights

90 mm Classic

Xenon dipped-beam headlight with gas discharge bulb.
Light aperture: 90 mm dia.
Reflector with lens bonded.

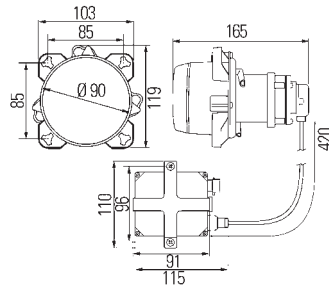

Part no.	Pk.	
1BL 008 194-001	1	Xenon dipped-beam headlight with 12V ballast unit
1BL 008 194-007	8	
1BL 008 194-027	1	with 24V ballast unit
1BL 158 060-021	1	Spare parts/Accessories: Light unit without gas discharge bulb and ballast unit
5DV 007 760-631	1	Ballast unit, 12V
5DV 007 810-171	1	24V
8HG 151 866-001	5	Mounting bracket for ballast unit, without rubber gasket
9XD 990 308-001	1	with rubber gasket
9XB 152 977-001	1	Actuator for headlight levellers (3 pcs.)
8JD 156 151-807	1	Socket set (20 pcs.)
9AH 157 659-007	1	Supporting frame
8GS 007 949-261	1	D2S gas discharge bulb, 35W

Light aperture: 90 mm dia.
Reflector with lens bonded.

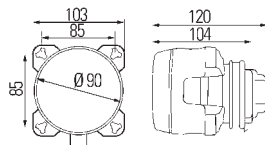

Part no.	Pk.	
1K0 008 191-001	1	FF H7 driving light with position light and 12V bulbs
1K0 008 191-007	36	
1K0 008 191-227	36	and 12V bulbs, without adjustable screws
1K0 008 191-021	1	and 24V bulbs
1K0 008 191-027	36	
1K0 008 191-212	1	and 24V HD bulb
1K0 008 191-011	1	FF H7 driving light without position light, with 12V bulb
1K0 008 191-017	36	
1K0 008 191-041	1	with 24V bulb
1K0 008 191-047	36	
9XB 152 977-001	1	Spare parts/Accessories: Actuator for headlight levellers (3 pcs.)
9GH 152 654-007	1	Rubber sealing cap for angular plug, with ventilation
9GH 145 943-001	1	for socket, with ventilation
8JD 156 150-807	1	Socket set (20 pcs.)
9AH 157 659-007	1	for T4W bulb
9NS 152 922-007	1	Supporting frame
9XS 124 218-027	500	Adjusting screw with lock points
8GH 007 157-121	500	Clamping piece
8GH 007 157-241	1	H7 bulb, 12V/55W
8GH 007 157-231	1	24V/70W
8GP 002 067-121	1	24V/70W (HDLL)
8GP 002 067-241	1	T4W bulb, 12V/4W
	10	12V/4W
	10	24V/4W

Built-in headlights

90 mm Classic

Light aperture: 90 mm dia.
Reflector with lens bonded.

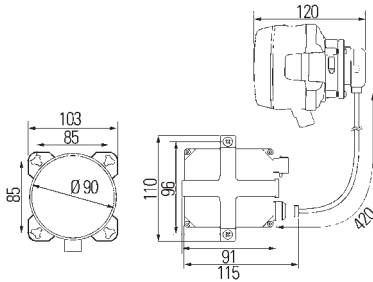
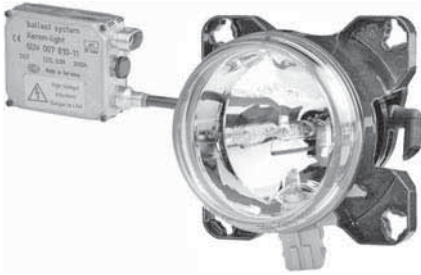

Part no.	Pk.	
1K0 008 192-001	1	Xenon driving light with position light, gas discharge bulb and 12V ballast unit
1K0 008 192-007	8	
1K0 008 192-027	1	and 24V ballast unit
1K0 008 192-011	1	Xenon driving light without position light, with gas discharge bulb and 12V ballast unit
1K0 008 192-017	8	
1K0 008 192-091	1	with gas discharge bulb and 24V ballast unit
Spare parts/Accessories:		
		Light unit
1K0 158 059-061	1	(for -001/-007/-027)
1K0 158 059-071	1	(for -011/-017/-091)
		Ballast unit,
5DV 007 760-631	1	12V
5DV 007 810-171	1	24V
		Holder for ballast unit
8HG 151 866-001	5	without rubber gasket
9XD 990 308-001	1	with rubber gasket
		Socket set (20 pcs.)
8JD 156 150-807	1	for T4W bulb
8JD 156 151-807	1	for ballast unit
9AH 157 659-007	1	Supporting frame
9NS 152 922-007	500	Adjusting screw with lock points
9XS 124 218-027	500	Clamping piece
8GS 007 949-261	1	D2S gas discharge bulb, 35W
		T4W bulb,
8GP 002 067-121	10	12V4W
8GP 002 067-241	10	24V4W

Built-in headlights

90 mm Performance

Light aperture: 90 mm dia. Plug connector HB4.

Reflector made of die-cast aluminium, glued to hardened glass lens.
3 attachment elements are enclosed.

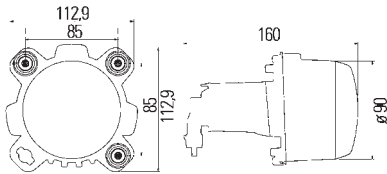

Part no.	Pk.	
1BL 247 042-001	1	DE H1 dipped-beam headlight with 12V bulb
1BL 247 042-007	36	
1BL 247 042-217	36	with 12V bulb, can be changed over to LES tourist solution
1BL 247 042-011	1	DE H1 dipped-beam headlight with 24V HDLL bulb
1BL 247 042-017	36	
		Spare parts/Accessories:
		Headlight levelling,
6NM 007 282-221	1	12V
6NM 008 299-501	1	24V
9XS 254 229-007	100	Joint for mounting the headlight leveller
8JD 156 151-807	1	Plug set (HB4)
9AH 254 228-012	2	Supporting frame
9AH 254 228-017	36	
9XD 254 226-007	500	Joint
9XD 254 227-007	500	Clamping piece
8GH 002 089-133	1	H1 bulb, 12V55W
8GH 002 089-251	1	24V70W
8GH 002 089-491	1	24V70W HDLL

Built-in headlights

90 mm Performance

Light aperture: 90 mm dia. Plug connector HB4.

Reflector made of die-cast aluminium, glued to hardened glass lens.
3 attachment elements are enclosed.

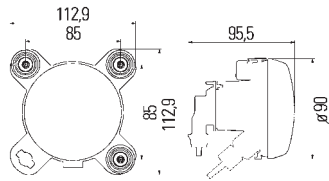

Part no.	Pk.	
1K0 247 043-001 1K0 247 043-007	1 36	FF H1 driving light with position light, 12V bulbs and Performance attachment
1K0 247 043-021 1K0 247 043-027	1 36	24V HDLL bulbs and Performance attachment
1K0 247 043-097	36	24V HDLL bulbs and Classic attachment
1K0 247 043-011 1K0 247 043-017	1 36	FF H1 driving light without position light, with 12V bulb and Performance attachment
1K0 247 043-031 1K0 247 043-037	1 36	with 24V HDLL bulb and Performance attachment
1K0 247 043-107	36	FF H1 driving light without position light, with 24V HDLL bulb and Classic attachment
Spare parts/Accessories:		
9AH 254 228-012	2	Supporting frame
9AH 254 228-017	36	
9XD 254 226-007	500	Joint
9XD 254 227-007	500	Clamping piece
8KA 202 117-011	1	Adapter lead from 2-pole HB4 plug connector to 4-pole FEP plug
8GH 002 089-133	1	H1 bulb,
8GH 002 089-251	1	12V55W
8GH 002 089-491	1	24V70W
		24V70W HDLL
		T4W bulb,
8GP 002 067-121	10	12V4W
8GP 002 067-241	10	24V4W

Built-in headlights

90 mm Performance

Can be changed over to LES tourist solution.

Light aperture: 90 mm dia. Plug connector HB4.

Reflector made of die-cast aluminium, glued to hardened glass lens.
3 attachment elements are enclosed.

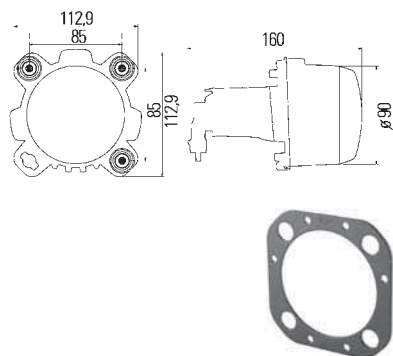

Part no.	Pk.	
1BL 247 042-177	36	DE H1 dipped-beam headlight with 12V bulb
1BL 247 042-197	36	with 24V bulb
1BL 247 042-157	36	with 24V HD bulb
Spare parts/Accessories:		
Headlight levelling,		
6NM 007 282-221	1	12V
6NM 008 299-501	1	24V
9XS 254 229-007	100	Joint for mounting the headlight leveller
8JD 156 151-807	1	Plug set (HB4)
9AH 254 228-012	2	Supporting frame
9AH 254 228-017	36	
9XD 254 226-007	500	Joint
9XD 254 227-007	500	Clamping piece
8GH 002 089-133	1	H1 bulb, 12V/55W
8GH 002 089-251	1	24V/70W
8GH 002 089-361	1	24V/70W HD

90 mm LED Module

DE-LED-dipped-beam light.

Dipped-beam light: 20.0W, position light: 2.0W,

daytime running light: 16.0W.

Light aperture: 90 mm dia.

Reflector and lens with clear-glass look made of plastic.
3 attachment elements are enclosed.

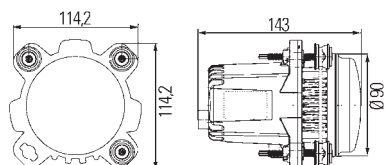

Part no.	Pk.	
1BL 012 488-001	1	DE LED dipped-beam headlight without LED function control, with 5-Chip-LEDs for dipped-beam light, 12V/24V
1BL 012 488-021	1	with 5-Chip-LEDs for dipped-beam light, with 16 LEDs for position light and daytime running light, 12V/24V
1BL 012 488-101	1	with 5-Chip-LEDs for dipped-beam light and 4-pole DT plug connector, 12V/24V
1BL 012 488-121	1	with 5-Chip-LEDs for dipped-beam light, 16 LEDs for position light and daytime running light and 4-pole DT plug connector, 12V/24V
Spare parts/Accessories:		
LED-control unit,		
5DS 011 630-001	1	12V
5DS 011 630-011	1	24V
9AH 169 580-011	1	Supporting frame
8JA 201 022-042	10	DT plug, 4-pole
Contents:		
1 DT plug connector, 1 DT wedgelock,		
5 bush contacts 0.5 - 2.0 sq. mm,		
3 dummy plugs, DT plug-set, 4-pole		
8JA 201 022-821	1	
9NB 201 024-042	10	Wedgelock
9NB 201 025-112	50	Contact sleeve
9NB 201 026-112	50	Dummy plug

Built-in headlights

90 mm Performance

Light aperture: 90 mm dia. With bulb(s). Plug connector HB4.
Reflector made of die-cast aluminium, glued to hardened glass lens.
3 attachment elements are enclosed.

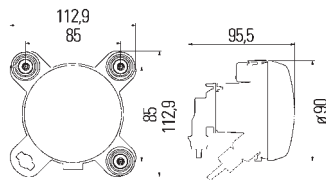

Part no.	Pk.	
1K0 247 043-117	36	FF H1 driving light with Premium attachment, with position light, 12V
1K0 247 043-127	36	without position light, 12V
1K0 247 043-137	36	with position light, 24V HDLL
1K0 247 043-147	36	without position light, 24V HDLL
1K0 247 043-157	36	FF H1 driving light with Classic attachment, with position light, 12V
1K0 247 043-167	36	without position light, 12V
Spare parts/Accessories:		
9AH 169 580-011	1	Supporting frame for -117/-127/-137/-147
9AH 157 659-007	20	for -157/-167
9XD 254 226-007	500	Joint
9XD 254 227-007	500	Clamping piece
8JD 156 151-807	1	Plug set (20 pcs.) for H1 bulb
8JD 156 150-807	1	for T4W bulb
8KA 202 117-011	1	Adapter lead from 2-pole HB4 plug connector to 4-pole FEP plug
8GH 002 089-133	1	H1 bulb, 12V55W
8GH 002 089-251	1	24V70W
8GH 002 089-491	1	24V70W HDLL
8GP 002 067-121	10	T4W bulb, 12V4W
8GP 002 067-241	10	24V4W

90 mm Bi-Xenon

Bi Xenon dipped-beam headlight and main light with gas discharge bulb.

Light aperture: 90 mm dia.
Reflector with lens bonded.

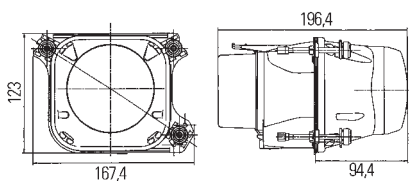

Part no.	Pk.	
1AL 008 934-001	1	Bi Xenon headlight with 12V ballast unit
1AL 008 934-021	1	with 24V ballast unit
Spare parts/Accessories:		
8JD 162 211-801	1	Socket set for main beam (20 pcs.)
8JA 990 295-127	10	2-pole DEUTSCH plug
8KB 990 299-221	1	Lead, 3700 mm, with DEUTSCH plug, relay and fuse, 12V
8KB 990 299-231	1	24V
8XX 010 315-001	1	Automatic ultrasonic headlight levelling with 4 m long lead, 12V
8XX 010 315-101	1	with 10 m long lead, 12V
8XX 010 315-011	1	with 4 m long lead, 24V
8GS 007 949-261	1	D2S gas discharge bulb, 35W

Built-in headlights

90 mm Premium Bi-Xenon

Bi Xenon dipped-beam headlight and driving light with gas discharge bulb, can be changed over to LES tourist solution. Light aperture: 90 mm dia.

Reflector made of die-cast aluminium, glued to hardened glass lens. 3 attachment elements are enclosed.

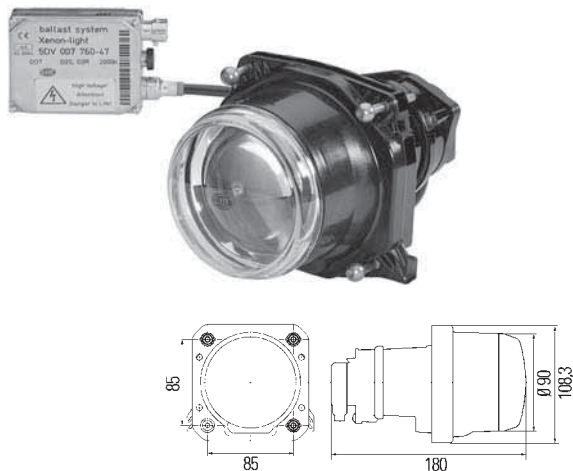

Part no.	Pk.	
1AL 009 997-001	1	Bi Xenon headlight with 12V ballast unit
1AL 009 997-041	1	with 24V ballast unit
Spare parts/Accessories:		
		Ballast unit,
5DV 007 760-631	1	12V
5DV 007 810-171	1	24V
9AH 169 580-011	1	Supporting frame
6NM 007 282-231	1	Headlight levelling incl. bracket, 12V
		Locking element for setting element, headlight levelling
9XD 198 241-002	100	Socket set (20 pcs.)
8JD 156 151-807	1	Superseal plug, 2-pole
8JA 746 184-022	10	Automatic ultrasonic headlight levelling
8XX 010 315-001	1	with 4 m long lead, 12V
8XX 010 315-101	1	with 10 m long lead, 12V
8XX 010 315-011	1	with 4 m long lead, 24V
8GS 007 949-261	1	D2S gas discharge bulb, 35W

90 mm Premium

Bi H7 dipped-beam headlight and driving light, can be changed over to LES tourist solution. Light aperture: 90 mm dia.

Reflector made of die-cast aluminium, glued to hardened glass lens.

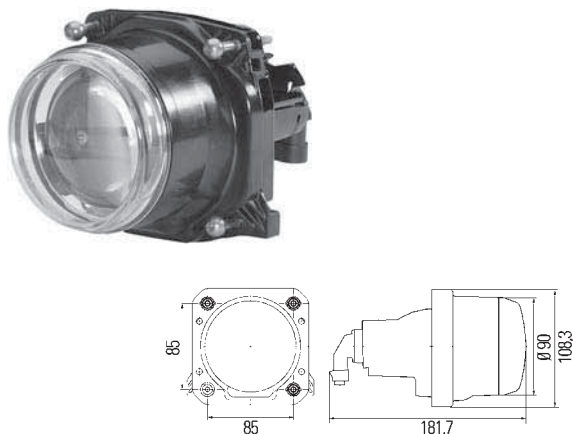

Part no.	Pk.	
1AL 009 998-001	1	Bi H7 dipped-beam headlight and driving light with 12V bulb
1AL 009 998-041	1	with 24V bulb
Spare parts/Accessories:		
9AH 169 580-011	1	Supporting frame
6NM 007 282-221	1	Headlight levelling incl. bracket, 12V
		Locking element for setting element, headlight levelling
9XD 198 241-002	100	Plug set (20 pcs.)
8JD 156 151-807	1	Superseal plug, 2-pole
8JA 746 184-022	10	Superseal jack contact
8KW 744 837-002	50	Superseal single conductor seal
9GD 746 185-002	50	H7 bulb,
8GH 007 157-121	1	12V55W
8GH 007 157-241	1	24V70W

Built-in headlights

90 mm Premium

DE H7 dipped-beam headlight, can be changed over to LES tourist solution. Light aperture: 90 mm dia.

Reflector made of die-cast aluminium, glued to hardened glass lens. 3 attachment elements are enclosed.

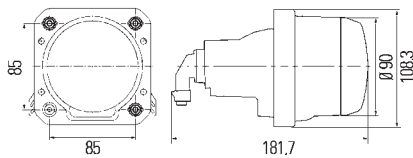

Part no.	Pk.	
1BL 009 999-001	1	DE H7 dipped-beam headlight with 12V bulb
1BL 009 999-041	1	with 24V bulb
Spare parts/Accessories:		
9AH 169 580-011	1	Supporting frame
9XD 198 241-002	100	Locking element for setting element, headlight levelling
8JD 156 151-807	1	Plug set (20 pcs.)
8JA 746 184-022	10	Superseal plug, 2-pole
8KW 744 837-002	50	Superseal jack contact
9GD 746 185-002	50	Superseal single conductor seal
8GH 007 157-121	1	H7 bulb, 12V55W
8GH 007 157-241	1	24V70W

90 mm LED Module

LED dipped-beam and driving light. With 3 white high-performance LEDs, 30W and lead. Light aperture: 90 mm dia.

Reflector and lens with clear-glass look made of plastic.

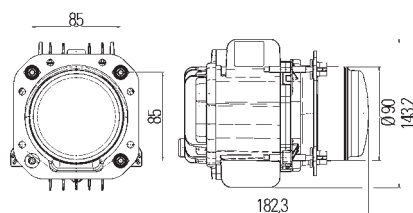

Part no.	Pk.	
1AL 010 820-841	1	Bi LED dipped-beam headlight set with LED function control, 12V
1AL 010 820-851	1	with LED function control, 24V
Spare parts/Accessories:		
LED control unit,		
5DS 011 630-001	1	12V
5DS 011 630-011	1	24V
Supporting frame		
9AH 169 580-011	1	for cars, mobile homes, buses
9AH 185 978-011	1	for trucks
8JA 746 184-022	10	Superseal plug, 2-pole
8KW 744 837-002	50	Superseal jack contact
9GD 746 185-002	50	Superseal single conductor seal

Built-in headlights

90 mm LED Module

LED dipped-beam headlight.
With 3 white high-performance LEDs, 30W and lead.
Light aperture: 90 mm dia.
 Reflector and lens with clear-glass look made of plastic.

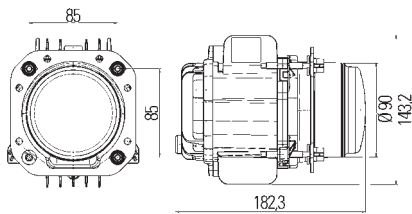

Part no.	Pk.	
1BL 010 820-001	1	LED dipped-beam headlight without LED function control, 12V/24V
1BL 010 820-801	1	LED dipped-beam headlight set with LED function control, 12V
1BL 010 820-811	1	with LED function control, 24V
Spare parts/Accessories:		
		LED control unit,
5DS 011 630-001	1	12V
5DS 011 630-011	1	24V
		Supporting frame
9AH 169 580-011	1	for cars, mobile homes, buses
9AH 185 978-011	1	for trucks
8JA 746 184-022	10	Superseal plug, 2-pole
8KW 744 837-002	50	Superseal jack contact
9GD 746 185-002	50	Superseal single conductor seal
		Adapter lead for retrofitting the existing performance/premium dipped-beam headlight to an LED dipped-beam headlight
8KA 194 768-001	1	1BL 010 820-001

LED dipped-beam and driving light.
With 6 white high-performance LEDs and lead.
Dipped beam light: 30W, driving light: 60W.
Light aperture: 90 mm dia.
 Reflector and lens with clear-glass look made of plastic.

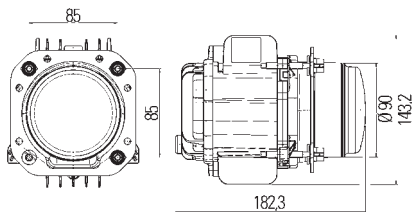

Part no.	Pk.	
For cars, mobile homes, buses and trucks.		
1AL 010 820-021	1	Bi LED dipped-beam and driving light without LED function control, 12V/24V
For trucks and tractors.		
1AL 010 820-067	42	Bi LED dipped-beam and driving light without LED function control, 12V/24V
Spare parts/Accessories:		
		LED control unit,
5DS 011 630-001	1	12V
5DS 011 630-011	1	24V
		Supporting frame
9AH 169 580-011	1	for cars, mobile homes, buses
9AH 185 978-011	1	for trucks
		Lead adapter for retrofitting
		Bi Halogen/Bi Xenon on Bi LED headlights,
8KA 194 768-011	1	10 cm long, for -021
8KA 194 768-031	1	5 cm long, for -021/-067

Built-in headlights

90 mm LED Module

With white LEDs, 5 LEDs for fog light, 4 LEDs for tracking light, 16 LEDs for daytime running light, 16 LEDs for position light.

Fog light: 16W, tracking light: 16W, daytime running light: 16W, position light: 2W.

With 4-pole FEP plug connector.

Light aperture: 90 mm dia.

Clear-glass look made of plastic.

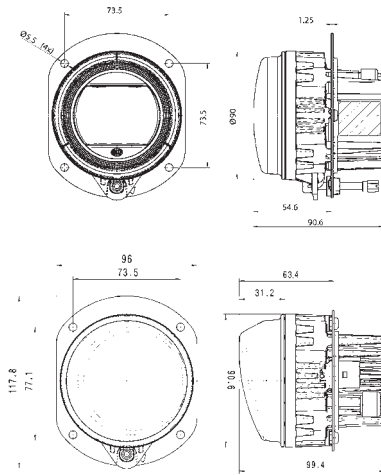

Part no.	Pk.	
1N0 011 988-001	1	LED fog light, 12V/24V
1N0 011 988-011	1	with daytime running light and side light, 12V/24V
1N0 011 988-051	1	with tracking light, left, 12V/24V
1N0 011 988-061	1	with tracking light, right, 12V/24V
Accessories:		
8KW 863 933-013	50	Plus supply LED FEP 4-pole plug Blade terminal contact Socket, 4-pole, 1,5 mm ²
8JA 202 231-002	10	for Micro Timer II
9GD 863 952-022	50	Single conductor seal, 0,35 - 0,5 mm ²
9GD 863 952-012	50	Single conductor seal, 0,75 mm ²
9GD 863 952-002	50	Dummy plug Adapter lead from 4-pole FEP plug to 4-pole DEUTSCH plug connector
8KA 202 117-001	1	
5DF 009 244-007	24	Tracking light unit Adapter lead from fog light to tracking light unit
8KB 163 160-811	1	

Built-in headlights

90 mm LED Module

With white LEDs, 5 LEDs for driving light,
16 LEDs for daytime running light, 16 LEDs for position light.
Driving light: 20W, daytime running light: 16W, position light: 2W.
With 4-pole FEP plug connector.
Light aperture: 90 mm dia.
Clear-glass look made of plastic.

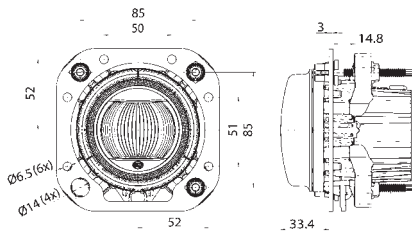
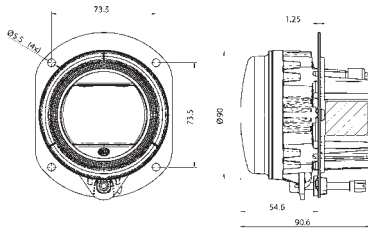

Part no.	Pk.	
1F0 011 988-021	1	LED driving light, 12V/24V
1F0 011 988-031	1	with daytime running light and side light, 12V/24V
1F0 011 988-121	1	with Performance attachment, 12V/24V
1F0 011 988-131	1	with daytime running light, position light and Performance attachment, 12V/24V
9AH 169 580-011	1	Accessories: Supporting frame for -121/-131, for cars, mobile homes, buses
8KW 863 933-013	50	Plus supply LED FEP 4-pole plug Blade terminal contact
8JA 202 231-002	10	Socket, 4-pole, 1,5 mm ² for Micro Timer II
9GD 863 952-022	50	Single conductor seal, 0,35 - 0,5 mm ²
9GD 863 952-012	50	Single conductor seal, 0,75 mm ²
9GD 863 952-002	50	Dummy plug
8KA 202 117-001	1	Adapter lead from 4-pole FEP plug connector to 4-pole DEUTSCH plug connector

Built-in headlights

90 mm LED Module

With 5 white LEDs for driving light and amber LED circle light module for indicator light.

Driving light: 20W.

With 4-pole FEP plug connector.

Light aperture: 90 mm dia.

Clear-glass look made of plastic.

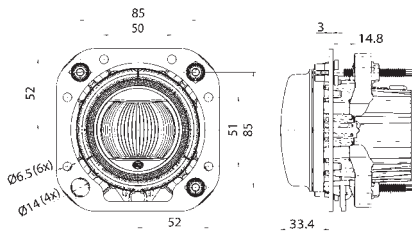
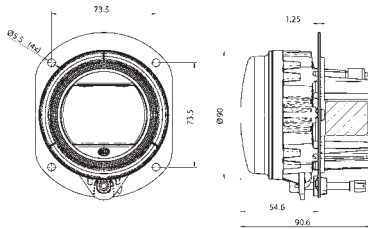

Part no.	Pk.	
1F0 011 988-071	1	LED driving light with indicator light, without pulse for indicator failure check, 12V/24V
1F0 011 988-081	1	with indicator failure check, 12V/24V
1F0 011 988-171	1	LED driving light with indicator light and Performance attachment, without pulse for indicator failure check, 12V/24V
1F0 011 988-181	1	with indicator failure check, 12V/24V
8KW 863 933-013	50	Accessories: Plus supply LED FEP 4-pole plug Blade terminal contact Socket, 4-pole, 1,5 mm ²
8JA 202 231-002	10	for Micro Timer II
9GD 863 952-022	50	Single conductor seal, 0,35 - 0,5 mm ²
9GD 863 952-012	50	Single conductor seal, 0,75 mm ²
9GD 863 952-002	50	Dummy plug
8KA 202 117-001	1	Adapter lead from 4-pole FEP plug connector to 4-pole DEUTSCH plug connector

Built-in headlights

For buses and mobile homes with 24V operating voltage.
Light with arched lens.
Without position light. Light aperture: 100 mm dia.

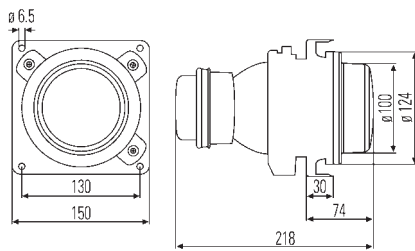
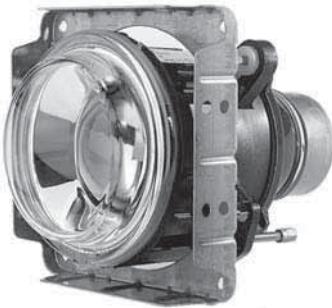

Part no.	Pk.	
1BL 007 834-037	1	Xenon dipped-beam headlight with gas discharge bulb and 24V ballast unit
1BL 007 834-007	1	DE H1 dipped-beam headlight with supporting frame
1BL 007 834-132	1	without supporting frame
1KL 007 834-027	1	DE H1 main-beam headlight
1NL 007 834-017	1	DE H1 fog light
Spare parts/Accessories:		
5DV 007 810-171	1	Ballast unit, 24V
8JD 156 151-807	1	Socket set (20 pcs.) for -037/-097
9GH 145 943-001	1	Rubber sealing cap for -027
9HD 155 239-001	12	Plastic sealing cap with lead and plug for -007/-017/-132
8GS 007 949-261	1	D2S gas discharge bulb, 35W
8GH 002 089-251	1	H1 bulb, 24V70W

For trucks, buses and vehicle tuners.
Headlight with flat lens.
Without position light. Light aperture: 100 mm dia.

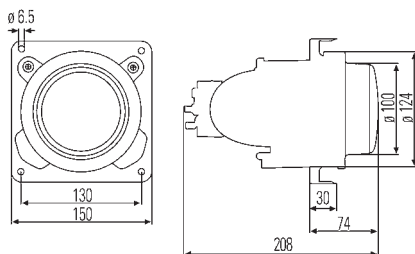
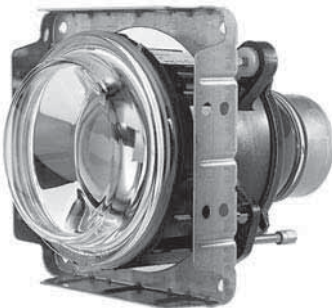

Part no.	Pk.	
1BL 007 834-047	1	DE H1 dipped-beam headlight suitable for headlight leveller
1KL 007 834-067	1	DE H1 main-beam headlight
1NL 007 834-057	1	DE H1 fog light
Spare parts/Accessories:		
6NM 004 375-541	3	Electr. headlight leveller, 12V for -047
8WS 008 549-001	1	Lens cleaning system with spray system, 12V
8WS 008 549-501	1	24V
9GH 145 943-001	1	Rubber sealing cap for -027/-067
9HD 155 239-001	12	Plastic sealing cap with lead and plug for -007/-017/-047/-057
8GH 002 089-133	1	H1 bulb, 12V55W
8GH 002 089-251	1	24V70W



Ultrasonic headlight levelling for 50 mm dia., 90 mm dia. and 100 mm dia. Xenon built-in headlights

Contents:

2 ultra-sonic sensors with mounting brackets, electronic control, 2 actuator motors, lead sets and installation instructions. The ultra-sonic sensor can be mounted on the floor of the car with a bracket and connected to the central electronic control. This control transfers its adjustment values to the actuator motors on the headlights in accordance with the specific load. If the vehicle height is reduced at the rear as well as the front axle when loaded, a second sensor is required. The control module is laid out for two-sensor operation.

Part no.	Pk.	
8XX 010 315-001	1	Automatic ultrasonic headlight levelling with 4 m long lead, 12V
8XX 010 315-101	1	with 10 m long lead, 12V
8XX 010 315-011	1	with 4 m long lead, 24V

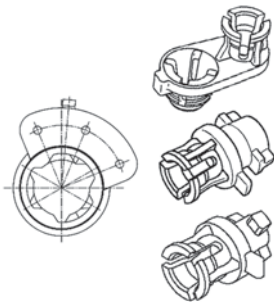

Headlight leveller accessory set for 50 mm dia. built-in headlights 1BL 009 071-... for 90 mm dia. built-in headlights 1BL 008 193-..., 1BL 008 194-..., 1BL 247 042-... In combination with the headlamp adjusters 6NM 007 282-221/-227/-231, 6NM 008 299-501

Contents:

1 bracket suitable for left and right, 3 joint pieces.

Part no.	Pk.	
8HG 183 586-001	1	Headlight leveller accessory set

Headlight cleaning system for 90 mm dia. and 100 mm dia. built-in headlights

For cleaning from 2 to 4 headlights.

Contents:

Pump, control module, lead set, nozzle and reinforced hose.

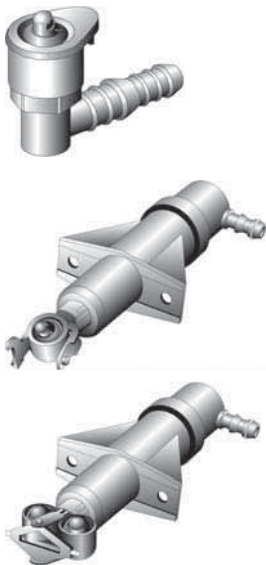

Part no.	Pk.	
8WS 008 549-001	1	Headlight cleaning system with fixed nozzles, 12V
8WS 008 549-501	1	
8WT 008 549-101	1	Headlight cleaning system with single telescopic nozzles, 12V
8WT 008 549-601	1	
8WT 008 549-201	1	Headlight cleaning system with double telescopic nozzles, 12V
8WT 008 549-701	1	
9GS 146 999-727	5	Spare parts: Hose

Built-in headlights

DE H1 dipped-beam headlight without position light.
Light aperture: 120 mm dia.

With adjustment screw for headlight leveller.
 For vehicles with 4-headlight-system.
 Only for spare parts requirement.

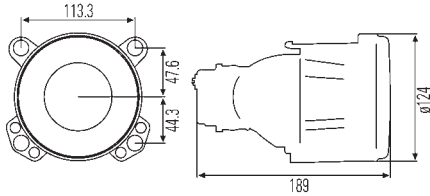
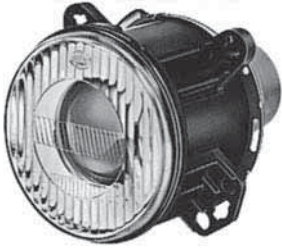

Part no.	Pk.	
1BL 006 349-007	1	DE H1 headlight in connection with driving light unit 1K2 006 147-031, with sealing cap and 12V bulb
1BL 006 349-011	1	in connection with driving light unit 1K2 006 147-051, without sealing cap and bulb
Spare parts/Accessories:		
8GH 002 089-133	1	H1 bulb, 12V55W
8GH 002 089-251	1	24V70W

DE H1 dipped-beam headlight without position light.
Light aperture: 130 mm dia.

For vehicles with 4-headlight-system.
 Only for spare parts requirement.



Part no.	Pk.	
1BL 139 277-031	1	DE H1 headlight, 24V, left
1BL 139 278-031	1	right
Accessories:		
8GH 002 089-251	1	H1 bulb, 24V70W

H3 driving light unit with position light.
Light aperture: 120 mm dia.

For vehicles with 4-headlight-system.
 Only for spare parts requirement.

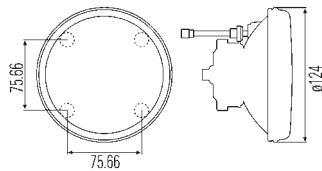

Part no.	Pk.	
1K2 006 147-031	1	H3 driving light, in connection with DE dipped-beam headlight 1BL 006 349-007, with sealing cap and 12V bulb
1K2 006 147-051	1	in connection with DE dipped-beam headlight 1BL 006 349-011, without sealing cap and bulb, 12V/24V
Spare parts/Accessories:		
8GH 002 090-133	1	H3 bulb, 12V55W
8GH 002 090-251	1	24V70W
8GP 002 067-121	10	T4W bulb, 12V4W
8GP 002 067-241	10	24V4W

Built-in headlights

With position light. Light aperture: 132 mm dia.
 Reflector made of plastic, glued to non-patterned glass lens.
 Three fixing screws are included separately in the package.
 In the case of new vehicles these can only be approved for agricultural and construction machinery.

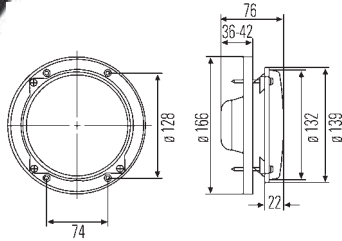

Part no.	Pk.	
1A3 996 162-381	1	H4 headlight with 12V bulbs
1A3 996 162-321	1	with 24V bulbs
1A3 996 162-071	1	with supporting frame made of plastic and 12V bulbs
Spare parts/Accessories:		
8GJ 002 525-131	1	H4 bulb, 12V60/55W
8GJ 002 525-251	1	24V75/70W T4W bulb,
8GP 002 067-121	10	12V4W
8GP 002 067-241	10	24V4W

With position light. Light aperture: 132 mm dia.
 Reflector made of sheet metal, glued to glass lens.

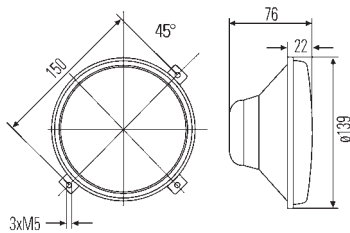

Part no.	Pk.	
1A3 996 002-051	1	R2 headlight without sealing cap
1A3 996 002-261	1	H4 headlight with sealing cap
Spare parts/Accessories:		
9HD 990 044-001	2	Sealing cap, red, for -261
8GD 002 088-141	1	R2 halogen bulb, 12V45/40W
8GD 002 088-271	1	24V55/50W
8GJ 002 525-131	1	H4 bulb, 12V60/55W
8GJ 002 525-251	1	24V75/70W T4W bulb,
8GP 002 067-121	10	12V4W
8GP 002 067-241	10	24V4W

Built-in headlights

Light aperture: 132 mm dia.
Supporting frame made of plastic.
Reflector made of sheet metal, glued to glass lens.

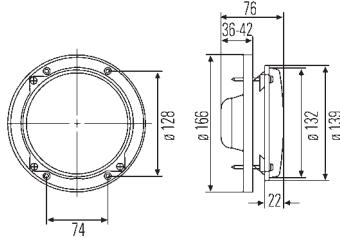

Part no.	Pk.	
1A3 996 002-181	1	H4 headlight with position light
1A3 996 002-211	1	without position light
1A3 996 002-531	1	with position light and hardened lens
Spare parts/Accessories:		
8GJ 002 525-131	1	H4 bulb, 12V60/55W
8GJ 002 525-251	1	24V75/70W T4W bulb,
8GP 002 067-121	10	12V4W
8GP 002 067-241	10	24V4W

Light aperture: 136 mm dia.
Supporting frame made of plastic.
Reflector made of plastic, glued to glass lens.
For Deutz vehicles. Only for spare parts requirement.

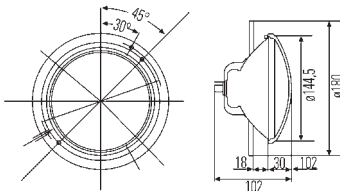

Part no.	Pk.	
1A3 003 370-041	1	R2 headlight
Spare parts/Accessories:		
1A3 125 195-015	2	Light unit
8GD 002 088-141	1	R2 halogen bulb, 12V45/40W

H4 headlight with sealing cap.
Light aperture: 135 mm dia.
e. g. for American and Japanese cars.
In accordance with SAE dimensions J 571.
Only for spare parts requirement.



Part no.	Pk.	
1A3 002 850-001	1	H4 headlight without position light
1A3 002 850-031	1	with position light and T4W bulb
1A3 005 649-007	1	without position light, for four-point mounting, for Claas
Spare parts/Accessories:		
9GH 126 647-011	10	Sealing cap for -001/-031
8GJ 002 525-131	1	H4 bulb, 12V60/55W
8GP 002 067-121	10	T4W bulb, 12V4W



Built-in headlights

Bi-Focus H1 dipped-beam headlight with position light.
Light aperture: 135 mm dia.

Can only be fitted in pairs. Can be used with 1K3 114 155-001.
 In accordance with SAE 4002 and 4005.
 Only for spare parts requirement.

Part no.	Pk.	
1B3 128 267-001	1	Bi-Focus H1 dipped beam headlight
1B3 128 267-071	1	with hardened glass
Spare parts/Accessories:		
9FF 085 642-001	10	Bulb holder for position light
8GH 002 089-133	1	H1 bulb, 12V55W
8GP 002 067-121	10	T4W bulb, 12V4W



H1 dipped-beam headlight with position light, without sealing cap.
Light aperture: 135 mm dia.

Can be used with 1K3 114 155-001.
 In accordance with SAE 4002 and 4005.
 Only for spare parts requirement.

Part no.	Pk.	
1B3 114 179-001	1	H1 dipped-beam headlight
Spare parts/Accessories:		
9FF 085 642-001	10	Bulb holder for position light
9HD 140 976-001	5	Cap
8GH 002 089-133	1	H1 bulb, 12V55W
8GP 002 067-121	10	T4W bulb, 12V4W



H1 driving light without sealing cap (see accessories).
Light aperture: 135 mm dia.

Can be used with 1K3 114 155-001.
 In accordance with SAE 4001.

Part no.	Pk.	
1K3 114 155-001	1	H1 driving light
Accessories:		
9HD 140 976-001	5	Cap
8GH 002 089-133	1	H1 bulb, 12V55W



With R2 light, without position light.
Light aperture: 135 mm dia.

Dipped-beam and driving headlight.
 In accordance with SAE 4002 and 4005.
 Only for spare parts requirement.

Part no.	Pk.	
1A3 001 120-001	1	R2 headlight
Spare parts/Accessories:		
8GD 002 088-141	1	R2 halogen bulb, 12V45/40W

Built-in headlights

Light aperture: 165 mm dia.

For vehicles with 7" light units, e.g. for American and Japanese cars.
In accordance with SAE 6006, SAE 6012, SAE 6013.
Only for spare parts requirement.



Part no.	Pk.	
1A6 002 395-031	1	H4 headlight without position light, with sealing cap
1A6 002 395-071	1	with position light and sealing cap
1A6 002 395-077	36	
1A6 002 395-387	36	with hardened lens, position light and sealing cap
1A6 002 395-821	1	H4 headlight set: 2 headlights with 12V bulbs, position light and sealing caps
Spare parts/Accessories:		
9GH 126 647-011	10	Sealing cap for -031/-387
8GJ 002 525-131	1	H4 bulb, 12V60/55W
8GP 002 067-121	10	T4W bulb, 12V4W

Light aperture: 165 mm dia.

For vehicles with 7" light units, e.g. for American and Japanese cars.
In accordance with SAE 6006, SAE 6012, SAE 6013.
Only for spare parts requirement.



Part no.	Pk.	
1A6 001 128-061	1	R2 headlight with position light, without bulb holder for position light
Spare parts/Accessories:		
9DS 088 583-001	2	Reflector with lens
8GD 002 088-141	1	R2 halogen bulb, 12V45/40W
8GP 002 067-121	10	T4W bulb, 12V4W

With H4 light.

Light aperture: 164 x 103 mm.

For American and Japanese cars with rectangular 4-headlamp system.
In accordance with SAE J 571.
Only for spare parts requirement.

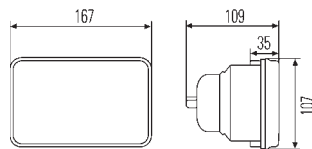
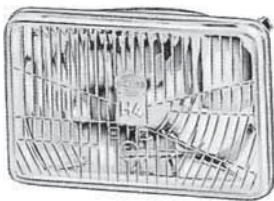

Part no.	Pk.	
1AB 003 177-001	1	H4 headlight without position light, with sealing cap
1AB 003 177-071	1	with position light and sealing cap
1AB 003 177-791	1	with hardened lens, position light and sealing cap, 24V
Accessories:		
8GJ 002 525-131	1	H4 bulb, 12V60/55W
8GJ 002 525-251	1	24V75/70W T4W bulb,
8GP 002 067-121	10	12V4W
8GP 002 067-241	10	24V4W

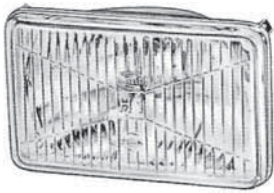

Built-in headlights

With H1 light.
Light aperture: 164 x 103 mm.
 For inner units. Mounting depth: 124 mm.

Part no.	Pk.	
1KB 003 177-061	1	H1 main beam headlight with sealing cap
Accessories:		
1VB 005 444-037	20	Receiving part
8GH 002 089-133	1	H1 bulb, 12V55W



With H2 light and sealing cap.
Light aperture: 164 x 103 mm.
 Can be used with 1AB 003 177-... and 1BL 005 380-...

Part no.	Pk.	
1NB 004 691-147	1	H2 fog light

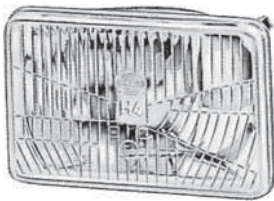
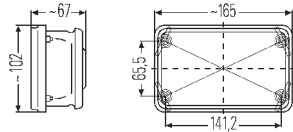

With H4 light, without position light.
With sealing cap. Light aperture: 164 x 103 mm.
 For John Deere.
 Only for spare parts requirement.

Part no.	Pk.	
1AB 006 977-021	1	H4 headlight
Accessories:		
8GJ 002 525-131	1	H4 bulb, 12V60/55W

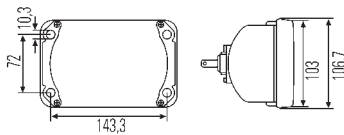

With R2 light, without position light.
With three-point fixing, sealing cap and 12V bulb.
Light aperture: 164 x 103 mm.
 For Landini and Massey-Ferguson.
 Only for spare parts requirement.

Part no.	Pk.	
1AB 003 177-611	1	R2 headlight
Spare parts:		
8GD 002 088-141	1	R2 halogen bulb, 12V45/40W

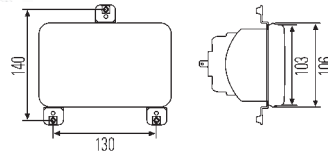

Built-in headlights

With H4 light and position light.
With three-point fixing, sealing cap and 12V bulb.
Light aperture: 164 x 103 mm.
 Only for spare parts requirement.

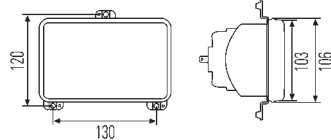
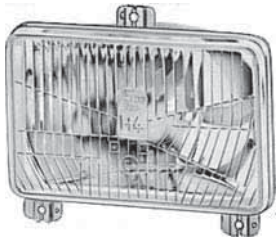

Part no.	Pk.	
1AB 006 277-127	36	H4 headlight
Spare parts:		
9GH 126 647-011	10	Cap
9FF 126 444-001	10	Bulb holder for position light
9KD 116 415-005	250	Pressure spring
8GJ 002 525-131	1	H4 bulb,
8GJ 002 525-251	1	12V60/55W
		24V75/70W
		T4W bulb,
8GP 002 067-121	10	12V4W
8GP 002 067-241	10	24V4W

With H4 light and three-point fixing.
Light aperture: 164 x 103 mm.

Reflector made of plastic, glued to non-patterned glass lens.
 With fixing screws M4 x 50 mm (DIN 7985)
 and pressure springs.
 Only for spare parts requirement.

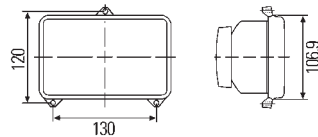

Part no.	Pk.	
1AB 008 888-041	1	H4 headlight with position light
1AB 008 888-051	1	without position light
Spare parts/Accessories:		
8GJ 002 525-131	1	H4 bulb,
8GJ 002 525-251	1	12V60/55W
		24V75/70W
		T4W bulb,
8GP 002 067-121	10	12V4W
8GP 002 067-241	10	24V4W

With H1 dipped-beam light, position light and sealing cap.
Light aperture: 164 x 103 mm.

For SAE headlight receiving unit.
 Can be used with 1KB 003 177-... and 1NB 004 691-...
 Only for spare parts requirement.

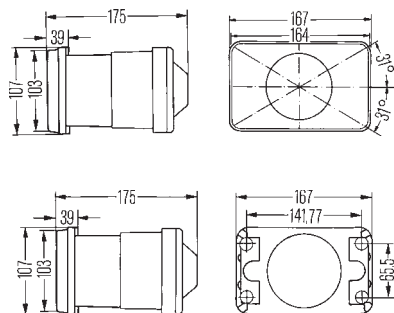

Part no.	Pk.	
1BL 005 380-011	1	DE H1 light unit, left
1BL 005 380-021	1	right
1BL 005 380-031	1	left
1BL 005 380-041	1	right
Accessories:		
8GH 002 089-133	1	H1 bulb, 12V55W
8GP 002 067-121	10	T4W bulb, 12V4W

Built-in headlights

With H4 light and sealing cap.
Light aperture: 190 x 132 mm.
 For American and Japanese cars
 with 2-headlamp system.
 Only for spare parts requirement.

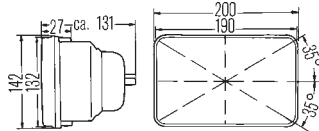

Part no.	Pk.	
1AE 003 427-011	1	H4 headlight without position light
1AE 003 427-021	1	with position light and 12V4W bulb
Spare parts/Accessories:		
9GH 126 647-011	10	Cap
8GJ 002 525-131	1	H4 bulb,
8GJ 002 525-251	1	12V60/55W
8GP 002 067-121	10	24V75/70W
8GP 002 067-241	10	T4W bulb,
		12V4W
		24V4W

With H4 light and position light.
Light aperture: 181 x 122 mm.
 For use on motorcycles.
 Only for spare parts requirement.

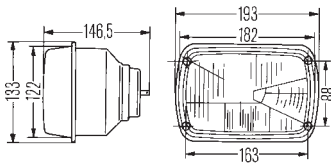
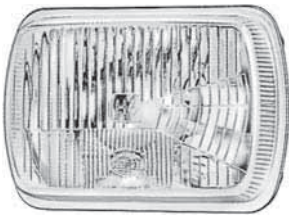

Part no.	Pk.	
1AD 003 305-001	1	H4 headlight
Accessories:		
8GJ 002 525-131	1	H4 bulb, 12V60/55W
8GP 002 067-121	10	T4W bulb, 12V4W

With H1 light, position light, hardened lens, sealing cap, supporting frame and adjustment devices.
Light aperture: 190 x 132 mm.
 Only for spare parts requirement.

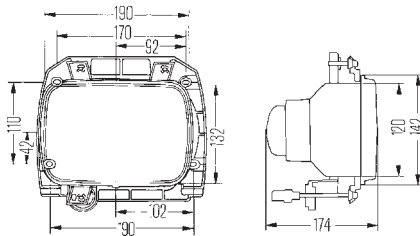

Part no.	Pk.	
1BL 005 740-091	1	DE H1 dipped-beam headlight, left
1BL 005 740-101	1	right
Accessories:		
8GH 002 089-133	1	H1 bulb,
8GH 002 089-251	1	12V55W
8GP 002 067-121	10	24V70W
8GP 002 067-241	10	T4W bulb,
		12V4W
		24V4W

Built-in headlights

With H1 light, sealing cap, supporting frame and adjustment devices.
Light aperture: 190 x 132 mm.

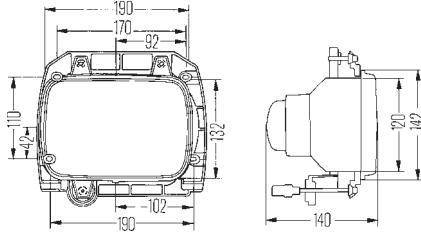
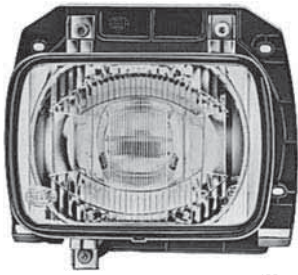

Part no.	Pk.	
1FE 005 478-011	1	H1 driving light, left
1FE 005 478-021	1	right
8GH 002 089-133	1	Accessories: H1 bulb, 12V55W

With H4 light, position light, sealing cap, supporting frame and adjustment devices.

Light aperture: 190 x 132 mm.
For SAE headlight receiving unit.
Only for spare parts requirement.

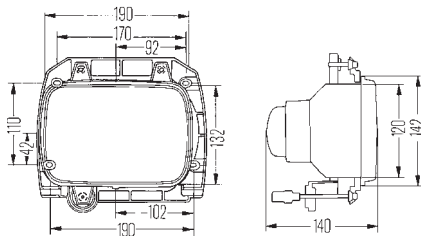
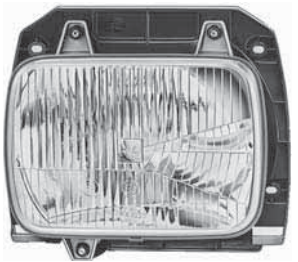

Part no.	Pk.	
1AE 003 427-151	1	H4 headlight, left
1AE 003 427-161	1	right
8GJ 002 525-131	1	Accessories: H4 bulb, 12V60/55W
8GJ 002 525-251	1	24V75/70W T4W bulb,
8GP 002 067-121	10	12V4W
8GP 002 067-241	10	24V4W

Built-in headlights

With H1 dipped-beam light, H1 driving light, position light and 12V bulbs.

Light aperture: 248 x 117 mm.
Only for spare parts requirement.

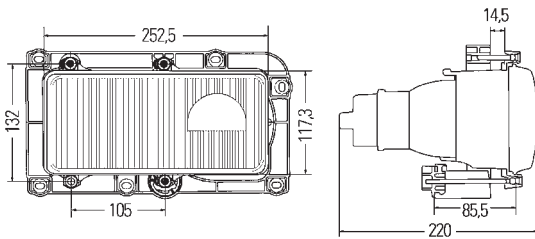
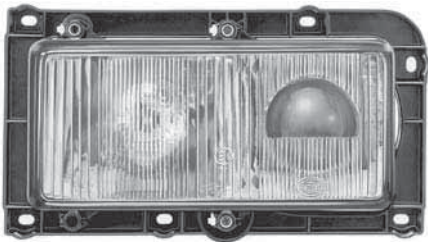
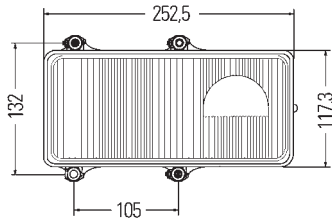

Part no.	Pk.	
1DL 005 600-097	1	DE H1 headlight, without lead, left
1DL 005 600-107	1	right
8GH 002 089-251	1	Spare parts: H1 bulb, 24V70W
8GP 002 067-241	10	T4W bulb, 24V4W
1DL 007 872-017	1	DE H1 headlight with electric headlight leveller and supporting frame, without lead, left
1DL 007 872-027	1	right
1DL 007 872-037	1	DE H1 headlight without electric headlight leveller, suitable for headlight leveller, without lead, left
1DL 007 872-047	1	right
1DL 007 872-077	1	DE H1 headlight without electric headlight leveller, suitable for headlight leveller, with lead, left
1DL 007 872-087	1	right
6NM 007 231-037	36	Spare parts: Headlight leveller, 24V for -017/-027
8GH 002 089-251	1	H1 bulb, 24V70W
8GP 002 067-241	10	T4W bulb, 24V4W

Built-in headlights

With sealing cap. Light aperture: 138 x 124 mm.

Supporting frame made of black plastic.

Type of protection: IP5K4K. Only for spare parts requirement.

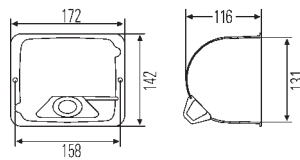
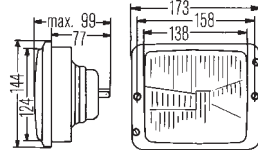

Part no.	Pk.	
1AA 004 109-031	1	R2 headlight with position light
1AA 004 109-001	1	without position light
Spare parts/Accessories:		
1AA 126 924-035	1	Light unit for -031
9FF 111 606-021	10	Bulb holder for position light
		R2 halogen bulb,
8GD 002 088-141	1	12V45/40W
8GD 002 088-271	1	24V55/50W
		T4W bulb,
8GP 002 067-121	10	12V4W
8GP 002 067-241	10	24V4W
9BG 127 426-001	4	Built-in body
<hr/>		
1AA 004 109-041	1	H4 headlight with position light and grey sealing cap
1AA 004 109-201	1	with position light and black sealing cap
1AA 004 109-021	1	without position light and gray sealing cap
Spare parts/Accessories:		
1AA 127 473-015	1	Light unit for -021
9FF 111 606-021	10	Bulb holder for position light
		H4 bulb,
8GJ 002 525-131	1	12V60/55W
8GJ 002 525-251	1	24V75/70W
		T4W bulb,
8GP 002 067-121	10	12V4W
8GP 002 067-241	10	24V4W
9BG 127 426-001	4	Built-in body

With position light. Light aperture: 125 x 140 mm.

Silver coloured lens-retaining rim.

Only for spare parts requirement.

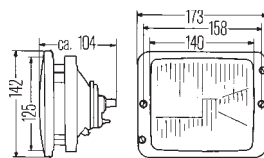

Part no.	Pk.	
1AB 001 100-001	1	R2 headlight for vehicles with max. speed of 40 km/h.
Spare parts:		
9AG 104 328-001	2	Lens-retaining rim with lens and adjusting devices
9DR 104 336-001	1	Reflector
9FH 093 887-001	10	Bulb holder
		R2 halogen bulb,
8GD 002 088-141	1	12V45/40W
8GD 002 088-271	1	24V55/50W
		T4W bulb,
8GP 002 067-121	10	12V4W
8GP 002 067-241	10	24V4W

Built-in headlights

With H4 light and position light.
Light aperture: 270 x 170 mm.

Mounting depth: 117 mm. Type of protection: IP5K4K.
Only for spare parts requirement.

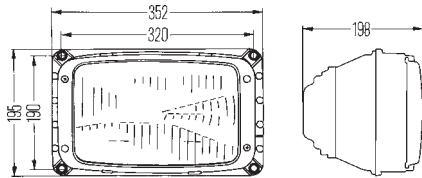
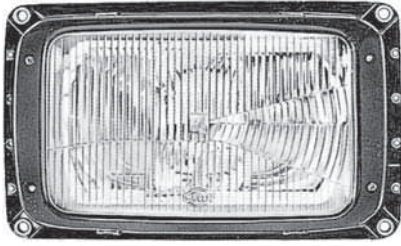

Part no.	Pk.	
1AG 003 434-051	1	H4 headlight with supporting frame made of black metal, suitable for headlight leveller
1AG 003 434-137	1	with plastic supporting frame, without device for light range regulation
1AG 003 434-251	1	with plastic supporting frame and device for light range regulation
Spare parts/Accessories:		
9ES 120 743-001	2	Lens Reflector
9DE 132 750-015	2	for -251
9HD 121 297-035	2	Sealing cap for - 251
9GT 067 751-001	10	Grommet H4 bulb,
8GJ 002 525-131	1	12V60/55W
8GJ 002 525-251	1	24V75/70W T4W bulb,
8GP 002 067-121	10	12V4W
8GP 002 067-241	10	24V4W

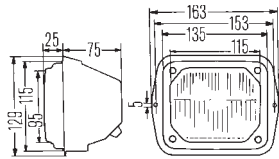

For vehicles with max. speed of 25 km/h,
e.g. for agricultural machines.

Light aperture: 115 x 95 mm.

Black plastic body and lens-retaining rim.
Only for spare parts requirement. National type test for Germany.

Part no.	Pk.	
1TA 003 570-001	1	Permanently dipped-beam headlight
Spare parts/Accessories:		
1TA 122 718-001	1	Light unit
8GP 002 067-121	10	T4W bulb, 12V4W

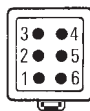
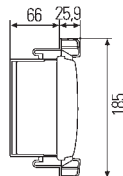
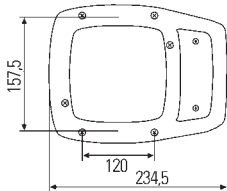

Built-in headlights

Module 120

With H7 dipped-beam light, H3 driving light, position light and indicator light (category 1 and 1a).

Light aperture: 120 x 120 mm.

With black rubber seal for sealing installation opening.

Black plastic lens-retaining rim with extending edge to protect lens.

Plastic reflector bonded with lens.

Type of protection: IPX9K.

Only for spare parts requirement.

Part no.	Pk.	
1EA 996 074-051	1	H7/H3 built-in headlight with grommet, left
1EA 996 074-061	1	right
1EA 996 074-177	30	H7/H3 built-in headlight with 24V bulbs and lead with 6-pole DEUTSCH plug connector, left
1EA 996 074-187	30	right
9EL 990 186-001	4	Spare parts/Accessories: Lens for indicator light
8GH 007 157-121	1	H7 bulb,
8GH 007 157-241	1	12V55W
8GH 002 090-133	1	24V70W
8GH 002 090-251	1	H3 bulb,
8GP 002 067-121	10	12V55W
8GP 002 067-241	10	24V70W
8GP 002 067-121	10	T4W bulb,
8GP 002 067-241	10	12V4W
8GP 002 067-241	10	24V4W
8GA 002 073-121	10	P21W bulb,
8GA 002 073-241	10	12V21W
8GA 002 073-241	10	24V21W

Symmetrical light, with position light.

Light aperture: 130 mm dia.

Chrome plated lens-retaining rim.

National type test for Germany.

Only for spare parts requirement.

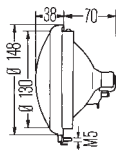
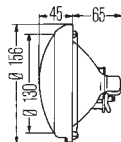

Part no.	Pk.	
1S3 001 440-00		S2 headlight (complete not available)
1S3 001 442-001	1	S2 headlight
9GD 024 183-001	10	Spare parts/Accessories: Gasket
9AG 071 903-001	5	Lens-retaining rim for 442-001
9KS 075 307-001	10	Lens-retaining spring for 440-00
9KS 071 571-001	10	for 442-001
9DR 066 847-001	1	Reflector
9FF 090 500-001	2	Bulb holder for position light
8GD 002 084-131	1	S2 bulb, 12V35/35W
8GP 002 067-121	10	T4W bulb, 12V4W

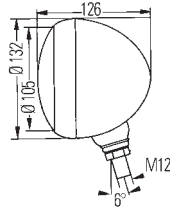

External-fitting headlights

Symmetrical light, with position light.
Light aperture: 105 mm dia.

Black body, with M12 fixing screw.
 For Claas. National type test for Germany.
 Only for spare parts requirement.

Part no.	Pk.	
1S0 001 430-011	1	S2 headlight
Spare parts/Accessories:		
9ES 012 060-011	1	Lens
9GD 023 639-001	10	Gasket
9DR 090 206-001	1	Reflector
9FF 090 500-001	2	Bulb holder for position light
9KS 075 139-001	10	Lens-retaining spring
8GD 002 084-131	1	S2 bulb, 35/35W
8GP 002 067-121	10	T4W bulb, 12V4W

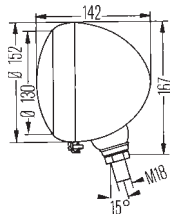

Symmetrical light, with position light.
Light aperture: 130 mm dia.

Black body made of sheet metal, with M18 x 32 hollow fixing bolt.
 National type test for Germany.
 Only for spare parts requirement.

Part no.	Pk.	
1S3 001 117-041	1	S2 headlight
Spare parts/Accessories:		
9ES 015 675-001	1	Lens
9GD 024 183-001	10	Gasket for lens
9DR 060 567-001	1	Reflector
9FF 090 500-001	2	Bulb holder for position light
9KS 075 307-001	10	Lens-retaining spring
8GD 002 084-131	1	S2 bulb, 35/35W
8GP 002 067-121	10	T4W bulb, 12V4W

External-fitting headlights

Combi 120

With H4 light, position light and indicator light with clear lens toward front and grey lens toward rear (category 1, 1a and 5).
 With 6-pole DEUTSCH plug connector. Light aperture: 161 x 100 mm.
 Reflector made of plastic, glued to non-patterned glass lens.
 Black plastic body and lens-retaining rim.

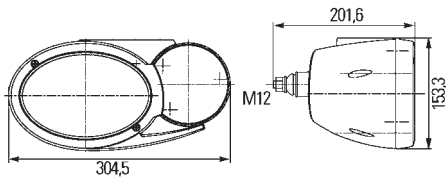
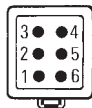
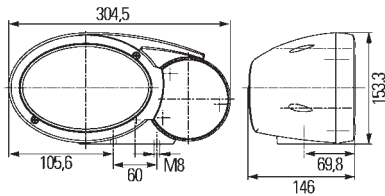
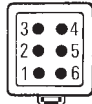

Part no.	Pk.	
1EB 996 167-031	1	H4 headlight with two M8 fixing screws (below) and 12V bulbs, left
1EB 996 167-038	18	
1EB 996 167-041	1	right
1EB 996 167-048	18	
1EB 996 167-177	18	H4 headlight with one M8 fixing screw (behind) for centre-mounting and 24V bulbs, left
1EB 996 167-187	18	
1AB 990 335-111	1	Spare parts/Accessories: Light unit Lens for indicator light, transparent toward the front, left transparent toward the front, right grey towards the rear, left grey towards the rear, right H4 bulb, 12V60/55W 24V75/70W T4W bulb, 12V4W 24V4W PY21W bulb, 12V21W 24V21W
9EL 990 354-011	1	
9EL 990 354-021	1	
9EL 990 354-031	1	
9EL 990 354-041	1	
8GJ 002 525-131	1	
8GJ 002 525-251	1	
8GP 002 067-121	10	
8GP 002 067-241	10	
8GA 006 841-121	10	
8GA 006 841-241	10	

External-fitting headlights

Combi 133

With H4 light, position light and indicator light.
 With 6-pole DEUTSCH plug connector and 24V bulbs.
 Light aperture: 135 mm dia.

Reflector made of plastic, glued to non-patterned glass lens.
 Black plastic body and lens-retaining rim.

Type of protection: IP5K4K.

In the case of new vehicles these can only be approved for agricultural and construction machinery.

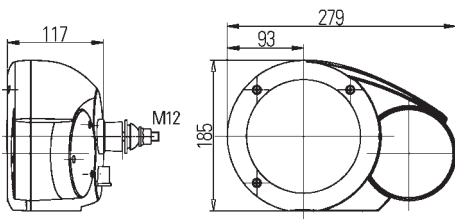
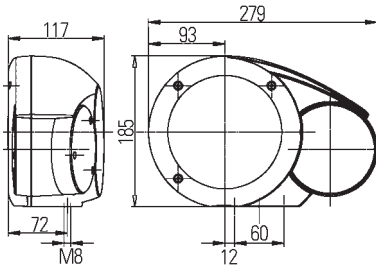

Part no.	Pk.	
1E3 996 160-671	1	H4 headlight with two M8 fixing screws (below) and indicator with amber lens toward front and rear (category 1, 1a and 5), left
1E3 996 160-681	1	right
1E3 996 160-637	18	H4 headlight with M12 fixing screw for centre-mounting (behind) and indicator light with clear lens toward front and grey lens toward rear, left
1E3 996 160-647	18	right
Spare parts/Accessories:		
9EL 990 354-121	1	Lens for indicator light, amber towards the front, right
9EL 990 354-131	1	amber towards the rear, left
9EL 990 354-141	1	amber towards the rear, right
9EL 990 354-011	1	transparent toward the front, left
9EL 990 354-021	1	transparent toward the front, right
9EL 990 354-031	1	grey towards the rear, left
9EL 990 354-041	1	grey towards the rear, right
8GJ 002 525-131	1	H4 bulb, 12V60/55W
8GJ 002 525-251	1	24V75/70W T4W bulb,
8GP 002 067-121	10	12V4W
8GP 002 067-241	10	24V4W
8GA 006 841-121	10	PY21W bulb, 12V21W
8GA 006 841-241	10	24V21W
8GA 002 073-121	10	P21W bulb, 12V21W
8GA 002 073-241	10	24V21W

External-fitting headlights

With H4 light. Light aperture: 132 mm dia.
 Black plastic body and lens-retaining rim.
 Universal bracket with M10 fixing screw.

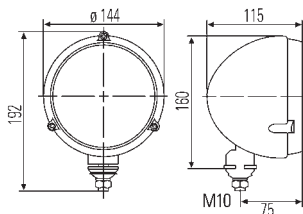

Part no.	Pk.	
1A3 996 002-191	1	H4 headlight without position light
1A3 996 002-161	1	with position light
Spare parts/Accessories:		
1A3 990 016-011	1	Light unit for -161
8GJ 002 525-131	1	H4 bulb, 12V60/55W
8GJ 002 525-251	1	24V75/70W T4W bulb,
8GP 002 067-121	10	12V4W
8GP 002 067-241	10	24V4W

With H4 light, 1800 mm long lead with contact pins and 12V bulb. Light aperture: 135 mm dia.

Reflector made of plastic, glued to non-patterned glass lens.
 Black fibre-glass reinforced plastic body and lens-retaining rim.
 Pivot base with M12 fixing screw.

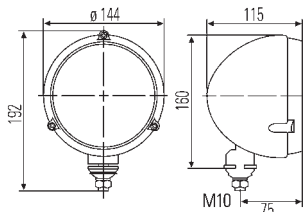

Part no.	Pk.	
1A3 996 162-607	30	H4 headlight without position light
Spare parts/Accessories:		
8GJ 002 525-131	1	H4 bulb, 12V60/55W

With H4 light. Light aperture: 135 mm dia.

Rubber body and suitable light units are to be ordered separately.
 Only for spare parts requirement.

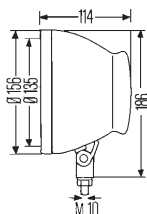

Part no.	Pk.	
1A3 002 850-001	1	H4 headlight without position light
1A3 002 850-031	1	with position light and T4W bulb
Spare parts/Accessories:		
9BG 127 179-001	1	Rubber body with universal bracket with fixing screw M10
8GJ 002 525-131	1	H4 bulb, 12V60/55W
8GP 002 067-121	10	T4W bulb, 12V4W

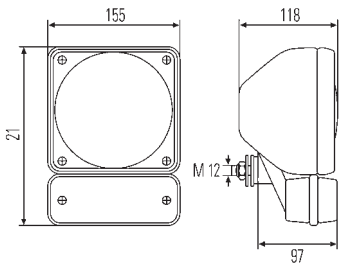

External-fitting headlights

With H4 light, position light and amber indicator light.
Light aperture: 135 mm dia.
 With attached amber indicator light (category 1, 1a and 5).
 Black plastic body.
 M12 fixing screw for centre-mounting.
 Only for spare parts requirement.

Part no.	Pk.	
1E5 996 124-001	1	H4 headlight
Spare parts/Accessories:		
1A3 002 850-031	1	Light unit
9EL 990 267-001	1	Lens for indicator light H4 bulb,
8GJ 002 525-131	1	12V60/55W
8GJ 002 525-251	1	24V75/70W T4W bulb,
8GP 002 067-121	10	12V4W
8GP 002 067-241	10	24V4W
8GA 002 073-121	10	P21W bulb, 12V21W
8GA 002 073-241	10	24V21W

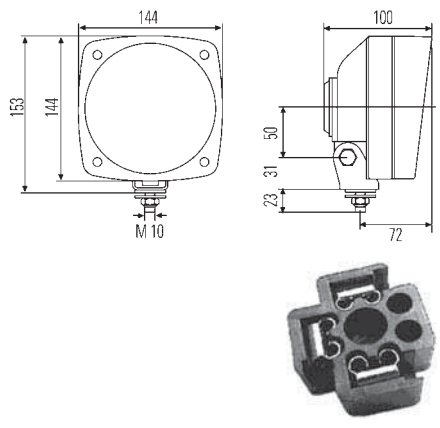

Light aperture: 140 mm dia.
 Black plastic body.
 Universal bracket with M10 fixing screw.
 Only for spare parts requirement.

Part no.	Pk.	
1A3 996 026-121	1	R2 headlight with position light
1A3 996 026-011	1	H4 headlight with position light
1A3 996 026-021	1	without position light
Accessories:		
8GD 002 088-141	1	R2 halogen bulb, 12V45/40W
8GD 002 088-271	1	24V55/50W H4 bulb,
8GJ 002 525-131	1	12V60/55W
8GJ 002 525-251	1	24V75/70W T4W bulb,
8GP 002 067-121	10	12V4W
8GP 002 067-241	10	24V4W
8JA 990 065-001	10	Plug for R2- and H4 bulb

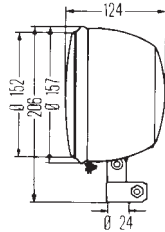

External-fitting headlights

With H4 light and position light.

Light aperture: 157 mm dia.

Body made of black sheet metal.

With spigot mount 24 mm dia.

Only for spare parts requirement.

Part no.	Pk.	
1A5 003 178-231	1	H4 headlight
Accessories:		
8GJ 002 525-131	1	H4 bulb, 12V60/55W
8GJ 002 525-251	1	24V75/70W T4W bulb,
8GP 002 067-121	10	12V4W
8GP 002 067-241	10	24V4W

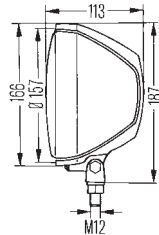

With position light. Light aperture: 157 mm dia.

Black plastic body. Type of protection: IP5K4K.

Only for spare parts requirement.

Part no.	Pk.	
1A5 003 178-411	1	R2 headlight with universal bracket with M12 fixing screw
1A5 003 178-401	1	with spigot mount 24 mm dia.
Accessories:		
8GD 002 088-141	1	R2 halogen bulb, 12V45/40W
8GD 002 088-271	1	24V55/50W T4W bulb,
8GP 002 067-121	10	12V4W
8GP 002 067-241	10	24V4W

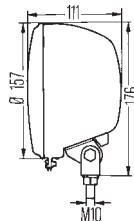

With H4 light, without position light. Light aperture: 157 mm dia.

Silver coloured steel body. Suitable for two-point fixing.

Universal bracket with M10 fixing screw.

Type of protection: IP5K4K.

Only for spare parts requirement.

Part no.	Pk.	
1A5 003 190-001	1	H4 headlight
Spare parts/Accessories:		
1A5 118 740-001	1	Light unit
8GJ 002 525-131	1	H4 bulb, 12V60/55W

External-fitting headlights

With H4 light. Light aperture: 175 mm dia.

Silver coloured steel body .

Universal bracket with M10 fixing screw.

Type of protection: IP5K4K. Only for spare parts requirement.

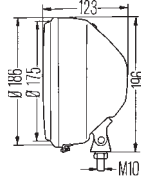

Part no.	Pk.	
1A7 003 099-001	1	H4 headlight without position light
1A7 003 099-011	1	with position light
Spare parts/Accessories:		
		Light unit for -001
1A7 117 596-001	1	for -001
1A7 118 750-001	1	for -011
		H4 bulb,
8GJ 002 525-131	1	12V60/55W
8GJ 002 525-251	1	24V75/70W
		T4W bulb,
8GP 002 067-121	10	12V4W
8GP 002 067-241	10	24V4W

For vehicles with max. speed of 25 km/h;

e. g. for agricultural machines.

With symmetrical light and position light. Light aperture: 115 x 95 mm.

Black plastic body and lens-retaining rim.

Universal bracket with M10 fixing screw.

Only for spare parts requirement. National type test for Germany.

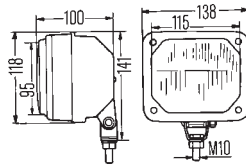

Part no.	Pk.	
1TA 003 570-101	1	Headlight with permanently dipped beam, 12V15W
Spare parts/Accessories:		
8GP 002 067-121	10	T4W bulb, 12V4W

External-fitting headlights

Module 120

With H7 dipped-beam light, H3 driving light, position light and attached amber indicator light with one lens each toward front and rear (category 1, 1a and 5).

Light aperture: 120 x 120 mm.

Plastic reflector bonded with lens.

Black plastic body with extending edge to protect lens

Universal bracket with M12 fixing screw.

Type of protection: IPX9K. Only for spare parts requirement.

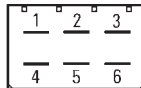
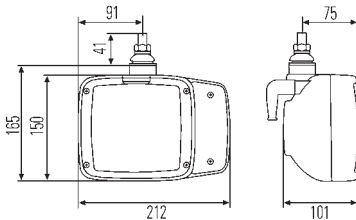
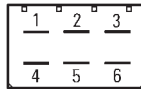
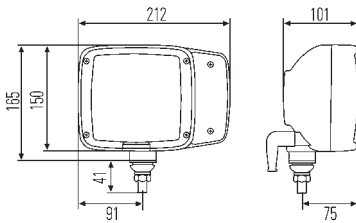
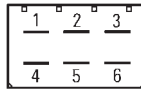

Part no.	Pk.	
		H7/H3 headlight for upright mounting, with 6-pole AMP plug connector and 12V bulbs, left
1EA 993 975-011	1	
1EA 993 975-017	40	
		right
1EA 993 975-021	1	
1EA 993 975-027	40	
		H7/H3 headlight for upright mounting, with 6-pole AMP plug connector and 24V bulbs, left
1EA 993 975-051	1	
1EA 993 975-057	40	
		right
1EA 993 975-061	1	
1EA 993 975-067	40	
		H7/H3 headlight for upright mounting, with 6-pole DEUTSCH plug connector and 12V bulbs, left
1EA 993 975-091	1	
1EA 993 975-097	20	
		right
1EA 993 975-101	1	
1EA 993 975-107	20	
		H7/H3 headlight for upright mounting, with 6-pole DEUTSCH plug connector and 24V bulbs, left
1EA 993 975-397	20	
		H7/H3 built-in headlight for pendant mounting, with 6-pole DEUTSCH plug connector and 24V bulbs, left
1EA 993 975-337	40	
1EA 993 975-347	40	right
		Spare parts/Accessories:
1EA 990 185-021	1	Light unit
9EL 990 186-001	4	Lens for indicator light, front
		H7 bulb,
8GH 007 157-121	1	12V55W
8GH 007 157-241	1	24V70W
		H3 bulb,
8GH 002 090-133	1	12V55W
8GH 002 090-251	1	24V70W
		T4W bulb,
8GP 002 067-121	10	12V4W
8GP 002 067-241	10	24V4W
		P21W bulb,
8GA 002 073-121	10	12V21W
8GA 002 073-241	10	24V21W
		6-pole socket for AMP plug connector
8JD 008 151-051	10	
9GH 993 988-007	1	Rubber cap for AMP plug connector
8KW 701 235-033	100	Blade receptacles, 6.3 mm
9GH 990 316-031	20	Rubber cap for Deutsch plug connector

External-fitting headlights

Module 120

With H7 dipped-beam light, H3 driving light, position light and attached amber indicator light with one lens each toward front and rear (category 1, 1a and 5).

With 12V bulbs. Light aperture: 120 x 120 mm.

Plastic reflector bonded with lens.

Black plastic body and lens retaining rim with extending edge to protect lens.

With M12 fixing screw for centre-mounting.

Type of protection: IPX9K.

Only for spare parts requirement.

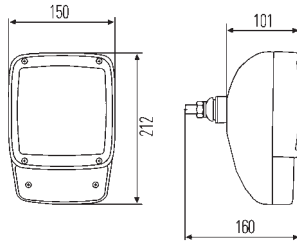
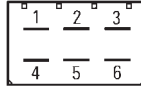

Part no.	Pk.	
1EA 996 081-171	1	H7/H3 headlight
1EA 996 081-177	24	with 6-pole AMP plug connector
Spare parts/Accessories:		
1EA 990 185-021	1	Light unit
9EL 990 186-001	4	Lens for indicator light, front
8GH 007 157-121	1	H7 bulb,
8GH 007 157-241	1	12V55W
8GH 002 090-133	1	24V70W
8GH 002 090-251	1	H3 bulb,
8GP 002 067-121	10	12V55W
8GP 002 067-241	10	24V70W
8GA 002 073-121	10	T4W bulb,
8GA 002 073-241	10	12V4W
8JD 008 151-051	10	24V4W
9GH 993 988-007	1	P21W bulb,
8KW 701 235-033	100	12V21W
		24V21W
		6-pole socket
		for AMP plug connector
		1 Rubber cap for AMP plug connector
		100 Blade receptacles, 6.3 mm

External-fitting headlights

Module 120

With H7 dipped-beam light, H3 driving light and position light.

Light aperture: 120 x 120 mm.

Plastic reflector bonded with lens.

Black plastic body and lens retaining rim with extending edge to protect lens.

Universal bracket with M12 fixing screw.

Type of protection: IPX9K.

Only for spare parts requirement.

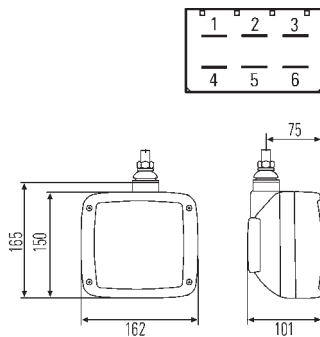
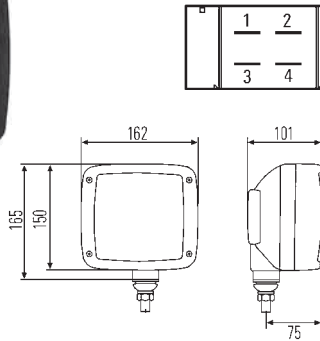

Part no.	Pk.	
1EA 996 127-001	1	H7/H3 headlight for upright mounting, with 4-pole AMP plug connector and 12V bulbs
1EA 996 127-007	175	
1EA 996 127-051	1	and 24V bulbs
1EA 996 127-077	54	H7/H3 headlight for pendant mounting, with 6-pole AMP plug connector and 24V bulbs
1EA 990 185-021	1	Spare parts/Accessories:
8GH 007 157-121	1	Light unit
8GH 007 157-241	1	H7 bulb, 12V55W
8GH 002 090-133	1	H3 bulb, 24V70W
8GH 002 090-251	1	H3 bulb, 12V55W
8GP 002 067-121	10	24V70W T4W bulb,
8GP 002 067-241	10	12V4W
8JD 008 151-041	10	24V4W
8JD 008 151-051	10	Socket, 4-pole
9GH 993 988-007	1	6-pole
8KW 701 235-033	100	Rubber cap for AMP plug connector
		Blade receptacles, 6.3 mm

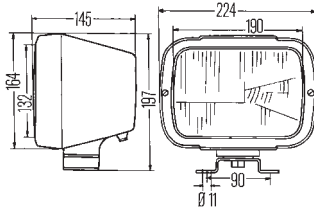
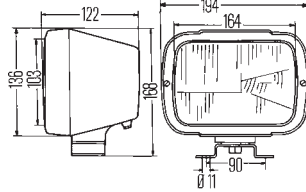
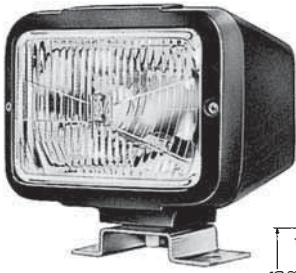

External-fitting headlights

With H4 light and position light.

Black plastic body and lens retaining rim.
Only for spare parts requirement.

Part no.	Pk.	
1AB 004 231-001	1	H4 headlight with light aperture 164 x 103 mm
1AE 004 234-001	1	with light aperture 190 x 132 mm
		Spare parts/Accessories:
		Light unit
1AB 003 177-071	1	for 004 231-001
1AE 003 427-021	1	for 004 234-001
9GH 126 647-011	10	Cap
8GJ 002 525-131	1	H4 bulb,
8GJ 002 525-251	1	12V60/55W
		24V75/70W
		T4W bulb,
8GP 002 067-121	10	12V4W
8GP 002 067-241	10	24V4W

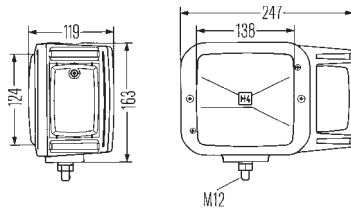
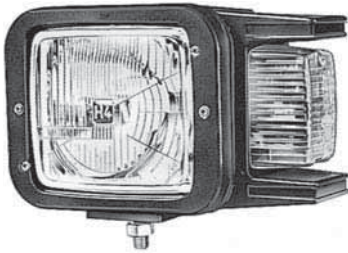

With H4 light, position light and amber indicator light (category 1 and 5). Light aperture: 138 x 124 mm.

Black plastic body and lens-retaining rim.
Universal bracket with M12 fixing screw.
Type of protection: IP5K4K.
Only for spare parts requirement.

Part no.	Pk.	
1EA 007 108-011	1	H4 headlight, left
1EA 007 108-017	30	
1EA 007 108-021	1	right
1EA 007 108-027	30	
		Spare parts/Accessories:
		Light unit
1AA 143 897-011	1	Bulb holder for position light
9FF 111 606-021	10	Lens for indicator light,
		right
8GJ 002 525-131	1	H4 bulb,
8GJ 002 525-251	1	12V60/55W
		24V75/70W
		T4W bulb,
8GP 002 067-121	10	12V4W
8GP 002 067-241	10	24V4W
8GA 002 073-121	10	P21W bulb,
8GA 002 073-241	10	12V21W
		24V21W

External-fitting headlights

Combi 220

With H7 dipped-beam light, H3 driving light, side light and attached clear indicator light (amber bulb) with auxiliary indicator light (category 1, 1a and 5).

With 6-pole DEUTSCH plug connector.

Light aperture: 205 x 120 mm.

Glas Plastic reflector bonded with lens.

Black plastic body with extending edge.

Type of protection: IP6K4K, IPX9K.

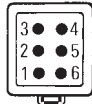
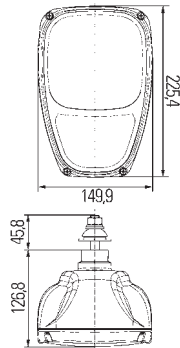
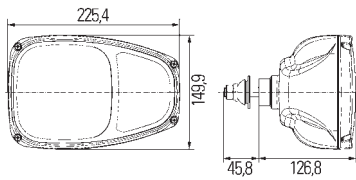
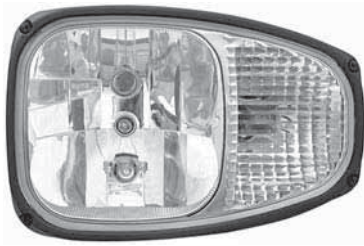

Part no.	Pk.	
1EE 996 174-211	1	H7/H3 headlight with central M12 fixing screw and 12V bulbs, left
1EE 996 174-221	1	and 12V bulbs, right
1EE 996 174-277	16	and 24V bulbs, left
1EE 996 174-287	16	and 24V bulbs, right
<hr/>		
1EE 996 174-337	16	H7/H3 headlight with central M12 fixing screw and 12V bulbs
1EE 996 174-387	16	H7/H3 headlight with central M12 fixing screw and 24V bulbs
Spare parts:		
8GH 007 157-121	1	H7 bulb, 12V55W
8GH 007 157-241	1	24V70W H3 bulb,
8GH 002 090-133	1	12V55W
8GH 002 090-251	1	24V70W T4W bulb,
8GP 002 067-121	10	12V4W
8GP 002 067-241	10	24V4W
8GA 006 841-121	10	PY21W bulb, 12V21W
8GA 006 841-241	10	24V21W

External-fitting headlights

Combi 220

With H7 dipped-beam light, H3 driving light, side light and attached clear indicator light (amber bulb) with auxiliary indicator light (category 1, 1a and 5).

With 6-pole DEUTSCH plug connector.

Light aperture: 205 x 120 mm.

Glas Plastic reflector bonded with lens.

Black plastic body with extending edge.

Type of protection: IP6K4K, IPX9K.

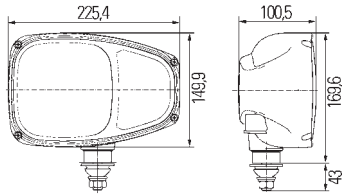

1EE 996 174-251

1

H7/H3 headlight with universal bracket with M12 fixing screw and 12V bulbs, left



1EE 996 174-261

1

right

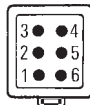

1EE 996 174-357

16

left

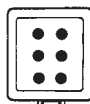

1EE 996 174-367

16

right



1EE 996 174-391

1

H7/H3 headlight with universal bracket with M12 fixing screw and 24V bulbs, left

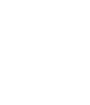

1EE 996 174-401

1

right



1EE 996 174-431

1

H7/H3 headlight with universal bracket with M12 fixing screw and 24V bulbs, contacting notwithstanding the standard version, left



1EE 996 174-441

1

right

8GH 007 157-121

1

Spare parts:

H7 bulb,

12V55W

8GH 007 157-241

1

24V70W

8GH 002 090-133

1

H3 bulb,

12V55W

8GH 002 090-251

1

24V70W

8GP 002 067-121

10

T4W bulb,

12V4W

8GP 002 067-241

10

24V4W

8GA 006 841-121

10

PY21W bulb,

12V21W

8GA 006 841-241

10

24V21W

External-fitting headlights

C 140

With dipped-beam light, driving light, position light and attached clear indicator light in LED-technology.

Dipped-beam light: 25W, driving light: 40W, indicator light: 8W, position light: 0,4W at 12V, dipped-beam light: 25W, driving light: 40W, indicator light: 7W, position light: 0,8W at 24V.

With 6-pole DEUTSCH plug connector.

Light aperture: 140 x 140 mm.

Reflector made of plastic, glued to non-patterned glass lens.

Black plastic body and lens retaining rim.

Voltage range: 12V - 24V.

Type of protection: IP6K4K and IPX9K.

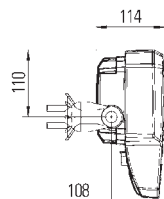
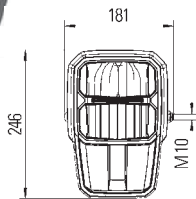
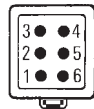
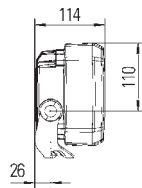
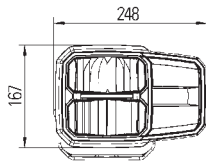
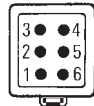

Part no.	Pk.	
1EE 996 374-011	1	LED headlight with U-bracket and M10 fixing screw for horizontal surface mounting, left
1EE 996 374-021	1	right
1EE 996 374-001	1	LED headlight with U-bracket and M10 fixing screw for vertical surface mounting

External-fitting headlights

5760

With H4 light. Light aperture: 120 mm dia.

Lens with steel reflector bonded.

Body and mounting frame made of black plastic.

Universal bracket with M10 fixing screw.

Type of protection: IP5K4K.

Rotates to permit mounting at 45° intervals in the vertical plane.

Only for spare parts requirement.

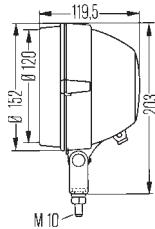
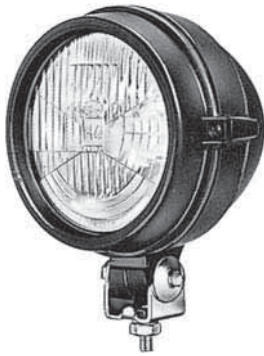

Part no.	Pk.	
1A3 005 760-501	1	H4 headlight without position light
1A3 005 760-507	60	
1A3 005 760-518	1	with position light
Accessories:		
		H4 bulb,
8GJ 002 525-131	1	12V60/55W
8GJ 002 525-251	1	24V75/70W
		T4W bulb,
8GP 002 067-121	10	12V4W
8GP 002 067-241	10	24V4W

External-fitting work lights for upright or pendant mounting

Lens pattern for long-range illumination.

Light aperture: 120 mm dia. With grommet.

Recommended angle of inclination: 15° - 20°.

Reflector made of sheet metal, glued to glass lens.

Black plastic body with extending edge to protect lens.

Pivot base with M10 fixing screw.

Without vibration damping. Type of protection: IP5K4K.

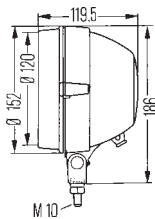
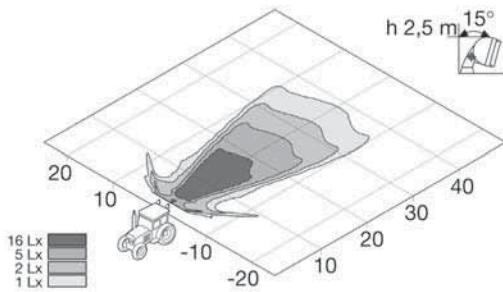

Part no.	Pk.	
1G3 005 760-221	1	H3 work light without handle, protective grill and switch
1G3 005 760-227	27	
1G3 005 760-021	1	H3 work light with handle, protective grill, switch and longer bracket holder
Spare parts/Accessories:		
		Light unit
1G3 135 211-011	1	
6EB 005 633-001	10	Switches
		H3 bulb,
8GH 002 090-271	1	12V35W
8GH 002 090-133	1	12V55W
8GH 002 090-251	1	24V70W

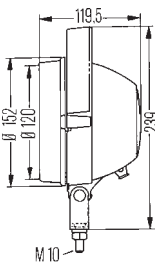

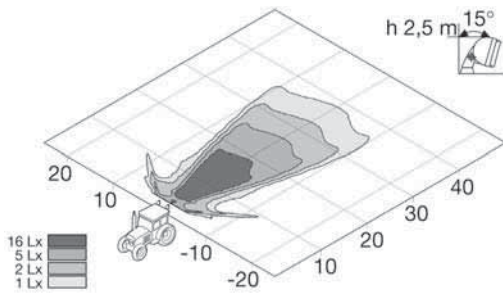

External-fitting work lights for upright or pendant mounting

5760

Lens pattern for long-range illumination.

Light aperture: 120 mm dia. With grommet.

Recommended angle of inclination: 15° - 20°.

Lens with steel reflector bonded.

Black plastic body with extending edge to protect lens.

Pivot base with M10 fixing screw.

Without vibration damping.

Type of protection: IP5K4K.

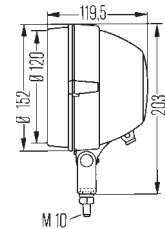
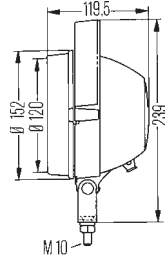

Part no.	Pk.	
1G3 005 760-001	1	H3 work light with handle and switch
1G3 005 760-011	1	with handle, without switch
1G3 005 760-031	1	with handle, without switch
1G3 005 760-201	1	without handle and switch
1G3 005 760-211	1	without handle, with switch and longer bracket holder
Spare parts/Accessories:		
1G3 135 211-011	1	Light unit
6EB 005 633-001	10	Switches
		H3 bulb,
8GH 002 090-271	1	12V35W
8GH 002 090-133	1	12V55W
8GH 002 090-251	1	24V70W

External-fitting work lights for upright or pendant mounting

5760

Lens pattern for close-range illumination. Light aperture: 120 mm dia.
Recommended angle of inclination: 15° - 20°.
Lens with steel reflector bonded.
Black plastic body with extending edge to protect lens.
Pivot base with M10 fixing screw.
Without vibration damping. Type of protection: IP5K4K.

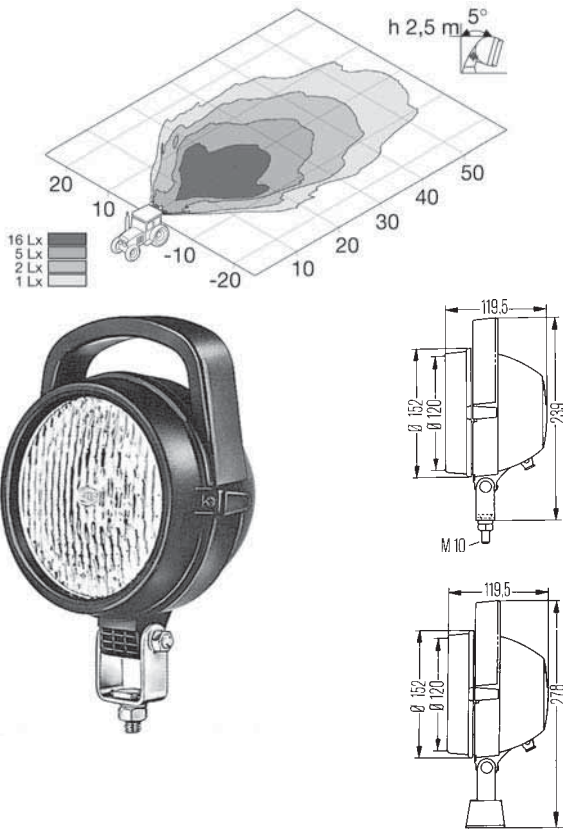

Part no.	Pk.	
1G3 005 760-041	1	H3 work light with handle and switch
1G3 005 760-057	1	with handle, switch and U-bracket for four-point mounting
Spare parts/Accessories:		
1G3 141 019-011	1	Light unit
6EB 005 633-001	10	Switches
9XD 130 261-001	5	Bracket for -057
8GH 002 090-271	1	H3 bulb, 12V35W
8GH 002 090-133	1	12V55W
8GH 002 090-251	1	24V70W

Built-in headlights

Oval 100

With H7 light. Light aperture: 130 x 75 mm.
Particularly suitable as a high-mounted headlight, if the main headlights are covered by devices mounted to the front.
Lens retaining rim, inclination adjustable by 6°. Reflector made of plastic, glued to non-patterned glass lens.
Black plastic lens retaining rim with extending edge to protect lens.
With B4.2 x 45 mm fixing screws.

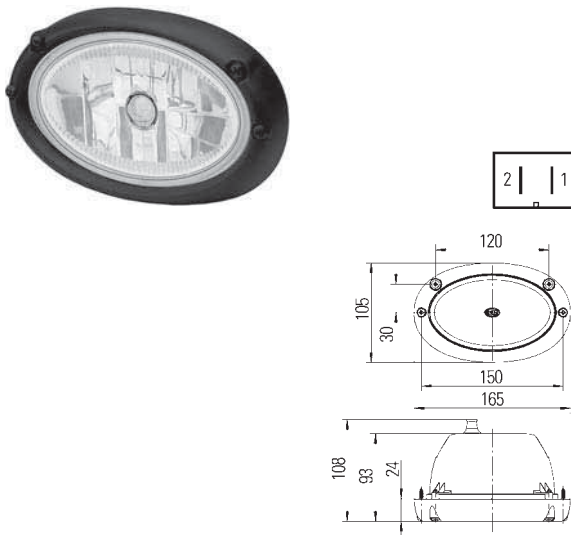

Part no.	Pk.	
1BA 996 261-021	1	H7 headlight with permanently dipped-beam with grommet and oval lens-retaining rim
1BA 996 261-197	30	with 12V bulb, 200 mm long lead with 2-pole AMP plug and oval lens-retaining rim
1KA 996 261-091	1	H7 driving light with grommet and oval lens-retaining rim
Spare parts/Accessories:		
8GH 007 157-121	1	H7 bulb, 12V55W
8GH 007 157-241	1	24V70W
9BG 990 342-001	1	Rubber body

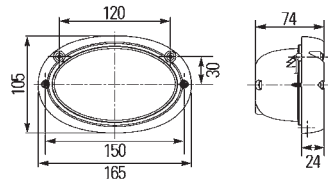
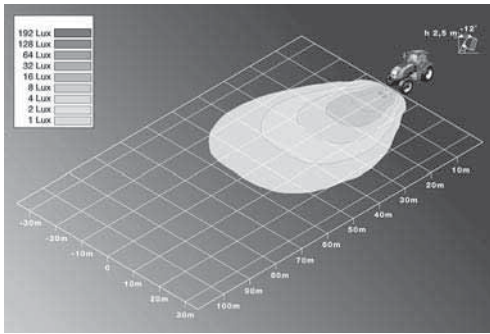

Built-in work lights

Oval 100 with FF reflector

Lens pattern for wide close-range illumination.

Light aperture: 130 x 75 mm.

Recommended angle of inclination: 10° - 15°.

Reflector made of die-cast aluminium, glued to hardened glass lens.

Two 4.0 x 40 mm fixing screws.

Mounting area: 142 x 92 mm. Type of protection: IP5K4K.

Part no.	Pk.	
1GA 996 161-111	1	Black plastic body with extending edge to protect lens. FF H3 work light with double reflector, 2-pole AMP plug connector and 12V55W bulbs
1GA 996 161-351	1	FF H3 work light with single reflector, 2-pole AMP plug connector and 12V55W bulb
1GA 996 161-681	1	Black fibre-glass reinforced plastic body with extending edge to protect lens. FF H3 work light with single reflector, 2-pole AMP plug connector and 12V55W bulb
		Spare parts/Accessories:
8GH 002 090-271	1	H3 bulb, 12V35W
8GH 002 090-133	1	12V55W
8GH 002 090-251	1	24V70W
9BG 990 342-001	1	Rubber body
9GH 993 984-001	20	Cap for AMP plug connector
8JD 008 151-011	10	Socket for AMP plug connector
8KW 701 235-033	100	Blade receptacles, 6.3 mm
8KB 990 299-001	1	2000 mm long connecting lead for AMP plug connector with cap

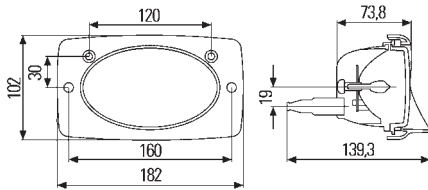
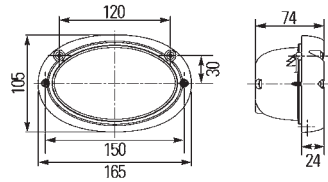
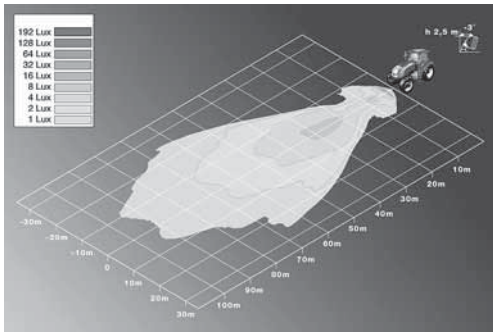

Built-in work lights

Oval 100 with FF reflector

Lens pattern for long-range illumination.

Light aperture: 130 x 75 mm.

Recommended angle of inclination: 5° - 10°.

Reflector made of diecast aluminium, glued to hardened glass lens.

Black plastic body with extending edge to protect lens.

Two 4.2 x 45 mm fixing screws.

Mounting area: 142 x 92 mm. Type of protection: IP5K4K.

Part no.	Pk.	
1GA 996 161-101	1	FF H3 work light with oval lens-retaining rim, lens without optical pattern, single reflector, 2-pole AMP plug connector with protection cap and 12V55W bulb
1GA 996 361-431	1	with grommet, without bulb
1GA 996 161-671	1	FF H3 work light fits into mounting holes of headlights 1AB/1GD 006 213-... Inclination 6°. With angular lens-retaining rim, lens without optical pattern, single reflector, 2-pole AMP plug connector with protection cap and 12V55W bulb
Spare parts/Accessories:		
8GH 002 090-271	1	H3 bulb, 12V35W
8GH 002 090-133	1	12V55W
8GH 002 090-251	1	24V70W
9BG 990 342-001	1	Rubber body
9GH 993 984-001	20	Cap for AMP plug connector
8JD 008 151-011	10	Socket for AMP plug connector
8KW 701 235-033	100	Blade receptacles, 6.3 mm
8KB 990 299-001	1	2000 mm long connecting lead for AMP plug connector with cap

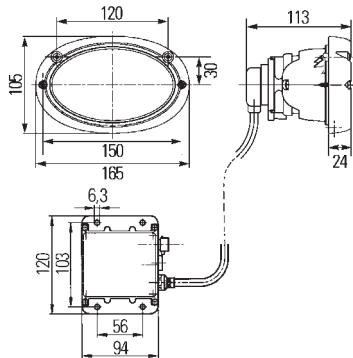
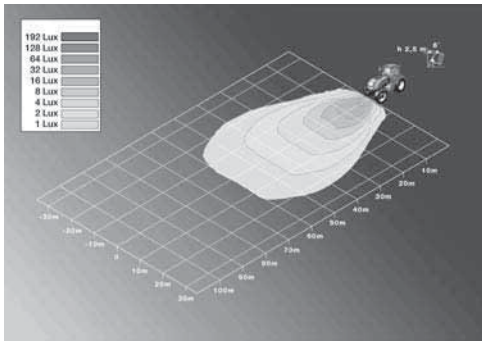

Built-in work lights

Oval 100 Xenon

Lens pattern for close-range illumination. With gas discharge bulb.
Light aperture: 130 x 75 mm.

Recommended angle of inclination: 10° - 15°.

Reflector made of die-cast aluminium, glued to hardened glass lens.

Black plastic body with extending edge to protect lens.

Two 4.0 x 40 mm fixing screws.

Mounting area: 142 x 92 mm. Type of protection: IP5K4K.

Part no.	Pk.	
1GA 996 361-581	1	Xenon work light with single reflector and 24V ballast unit
Spare parts/Accessories:		
5DV 007 810-171	1	Ballast unit, 24V
8GS 007 949-261	1	D2S gas discharge bulb, 35W
9BG 990 342-001	1	Rubber body
8JD 156 151-807	1	Socket set for ballast unit (20 pcs.)

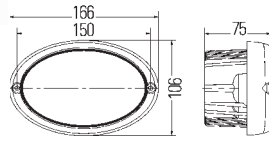

Built-in work lights

Oval 100 LED

With 8 Power LEDs 25W. Light aperture: 135 x 85 mm. 2-pole DEUTSCH plug connector integrated.

High sheen reflector made of plastic glued to Nylon lens.
Black aluminium housing with cooling ribs.
Voltage range: 12V - 24V.
Type of protection: IP6K7 and IP6K9K.

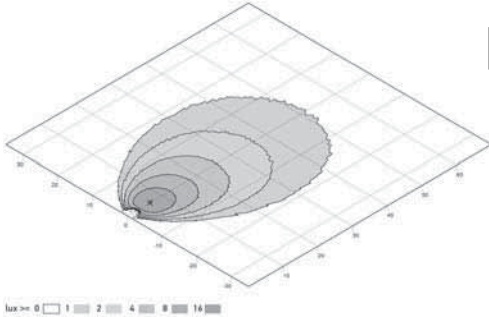

Part no.	Pk.	
1GA 996 661-021	1	LED work light, 1700 lm, with lens pattern for close-range illumination
1GA 996 661-061	1	with lens pattern for long-range illumination
8KB 990 299-011	1	Accessories: 2000 mm long connecting lead for DEUTSCH plug connector with cap

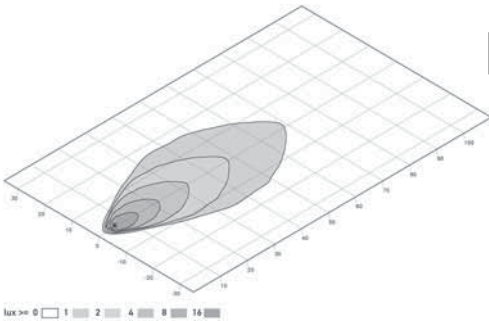

External-fitting work lights for upright or pendant mounting

Oval 100 with FF reflector

With 24V70W bulb. Light aperture: 130 x 75 mm.

Reflector made of diecast aluminium, glued to hardened glass lens.
Black fibre-glass reinforced plastic body and red lens-retaining rim with extending edge to protect lens.
Pivot base made of stainless steel with M10 fixing screw.
Type of protection: IP5K9K, IP67.
Schutzart: IP5K9K, IP67.

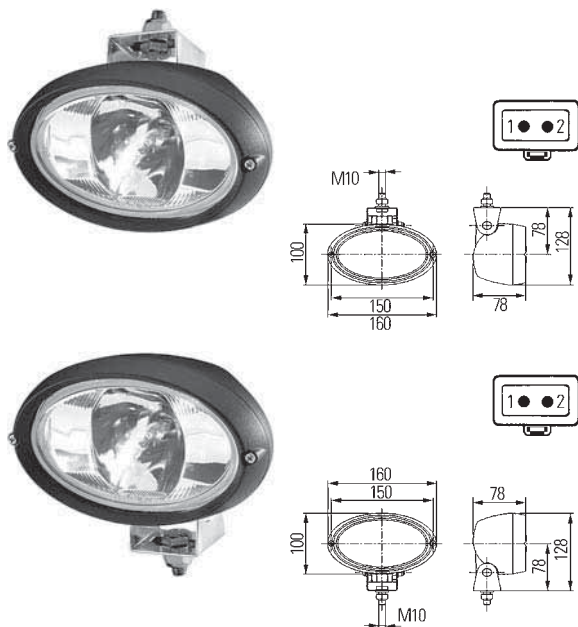

Part no.	Pk.	
1GA 996 361-447	30	FF H3 work light lens without optical pattern, single reflector and 2-pole AMP plug connector, for pendant mounting, lens pattern for long-range illumination
1GA 996 561-357	30	for pendant mounting, lens pattern for close-range illumination
1GA 996 361-497	30	for upright mounting, lens pattern for close-range illumination
Spare parts/Accessories:		
		H3 bulb,
8GH 002 090-271	1	12V35W
8GH 002 090-133	1	12V55W
8GH 002 090-251	1	24V70W
8JA 990 295-127	10	2-pole DEUTSCH plug
8HG 990 263-111	1	Mounting bracket for tubular mount on 15 mm - 28 mm dia. pipes
9XD 990 298-031	1	Angular bracket

External-fitting work lights for upright mounting

Lens pattern for long-range illumination.

Light aperture: 130 x 75 mm.

Recommended angle of inclination: 10° - 15°.
Reflector made of die-cast aluminium glued to hardened glass lens.
Black plastic body with extending edge to protect lens.
Pivot base with M10 fixing screw.
Type of protection: IP5K4K.

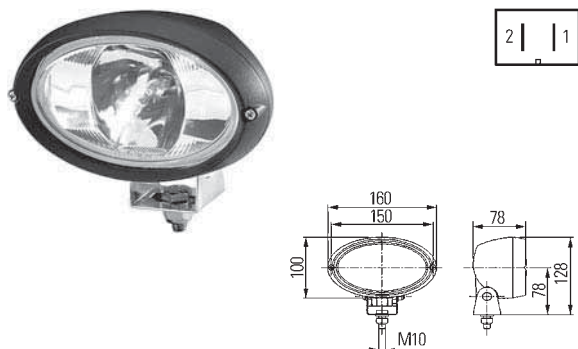
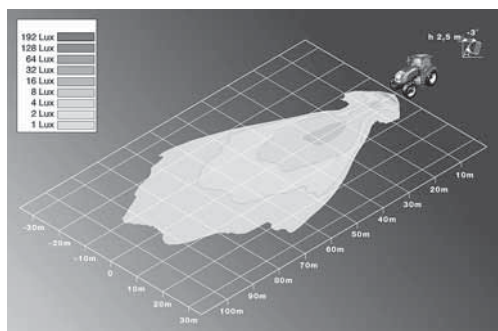

Part no.	Pk.	
1GA 996 161-281	1	FF H3 work light lens without optical pattern, single reflector, 2-pole AMP plug connector with protection cap and 12V55W bulb
Spare parts/Accessories:		
9GH 993 984-001	20	Cap for AMP plug connector
		H3 bulb,
8GH 002 090-271	1	12V35W
8GH 002 090-133	1	12V55W
8GH 002 090-251	1	24V70W
8JD 008 151-011	10	Socket for AMP plug connector
8KW 701 235-033	100	Blade receptacles, 6.3 mm
8KB 990 299-001	1	2000 mm long connecting lead for AMP plug connector with cap
8HG 990 263-111	1	Mounting bracket for tubular mount on 15 mm - 28 mm dia. pipes
9XD 990 298-031	1	Angular bracket

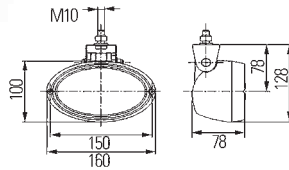
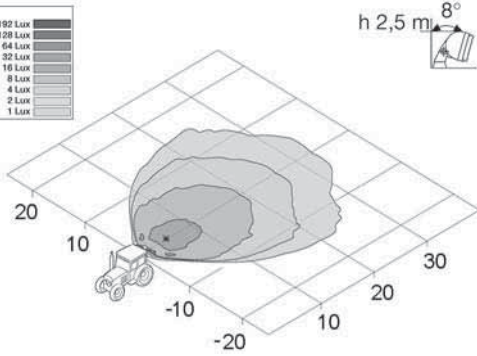
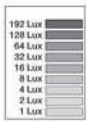

External-fitting work lights for pendant mounting

Oval 100 with FF reflector

Lens pattern for close-range illumination.

Light aperture: 130 x 75 mm.

Recommended angle of inclination: 10° - 15°.

Reflector made of die-cast aluminium glued to hardened glass lens.

Black plastic body with extending edge to protect lens.

Pivot base with M10 fixing screw.

Type of protection: IP5K4K.

Part no.	Pk.	
1GA 996 461-747	30	FF H3 work light lens without optical pattern, single reflector, 2-pole AMP plug connector with protection cap and 12V55W bulb
Spare parts/Accessories:		
9GH 993 984-001	20	Cap for AMP plug connector
8GH 002 090-271	1	H3 bulb,
8GH 002 090-133	1	12V35W
8GH 002 090-251	1	12V55W
8JD 008 151-011	1	24V70W
8KW 701 235-033	100	Socket for AMP plug connector
8KB 990 299-001	1	Blade receptacles, 6.3 mm
8HG 990 263-111	1	2000 mm long connecting lead for AMP plug connector with cap
		Mounting bracket for tubular mount on 15 mm - 28 mm dia. pipes

External-fitting work lights for vertical surface-mounting to forklifts

Oval 100 FL

Lens pattern for wide close-range and object illumination.

Light aperture: 130 x 75 mm.

Recommended angle of inclination: 0°.

Reflector made of die-cast aluminium glued to hardened lens.

Black plastic body and lens-retaining rim.

Pivot base with M10 fixing screw.

With 430 mm long connection lead.

Type of protection: IP6K9K and IPX9K.

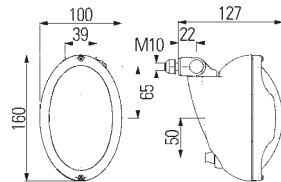

Part no.	Pk.	
1GN 996 361-461	1	H3 work light with non-patterned glass lens, grommet and 12V55W bulbs
Spare parts/Accessories:		
		H3 bulb,
8GH 002 090-271	1	12V35W
8GH 002 090-133	1	12V55W
8GH 002 090-251	1	24V70W

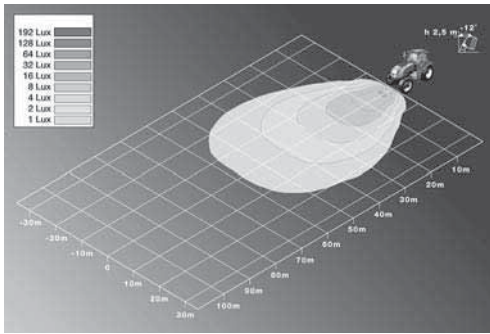

External-fitting work lights for upright or pendant mounting

Oval 100 with FF reflector

Lens pattern for wide ground illumination.
With 2-pole AMP plug connector and protection cap.
Light aperture: 130 x 75 mm.

Recommended angle of inclination: 10° - 15°.
 Reflector made of die-cast aluminium, glued to hardened glass lens.
 Black plastic body with extending edge to protect lens.
 Pivot base with M10 fixing screw.
 Pivot range vertical 105°.

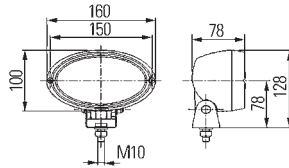

Part no.	Pk.	
1GA 996 161-291	1	FF H3 work light with double reflector and 12V55W bulbs
Spare parts/Accessories:		
9GH 993 984-001	20	Cap for AMP plug connector
		H3 bulb,
8GH 002 090-271	1	12V35W
8GH 002 090-133	1	12V55W
8GH 002 090-251	1	24V70W
8JD 008 151-011	10	Socket for AMP plug connector
8KW 701 235-033	100	Blade receptacles, 6.3 mm
8KB 990 299-001	1	2000 mm long connecting lead for AMP plug connector with cap
8HG 990 263-111	1	Mounting bracket for tubular mount on
9XD 990 298-031	1	15 mm - 28 mm dia. pipes
		Angular bracket

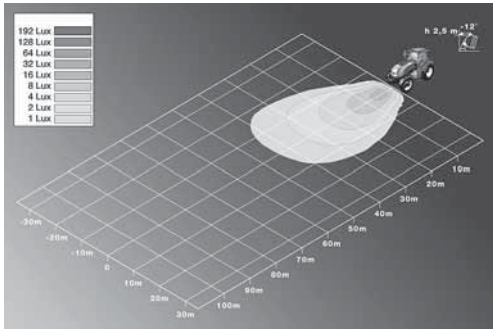

External-fitting work lights for upright or pendant mounting

Oval 100 with FF reflector

Lens pattern for wide close-range illumination.

Light aperture: 130 x 75 mm.

Recommended angle of inclination: 10° - 15°.

Reflector made of die-cast aluminium, glued to hardened glass lens.

Black plastic body with extending edge to protect lens.

Pivot base with M10 fixing screw.

Pivot range vertical 105°.

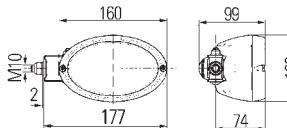
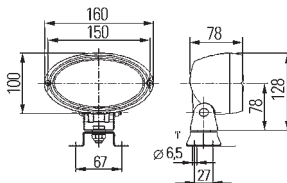
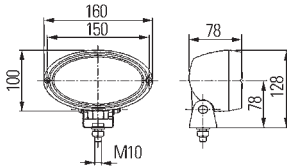

Part no.	Pk.	Description
1GA 996 361-421	1	FF H3 work light Type of protection: IP5K4K, with single reflector and grommet, without bulb
1GA 996 361-501	1	with lens without optical pattern, single reflector and grommet, without bulb
1GA 996 161-121	1	FF H3 work light Type of protection: IP5K4K and IPX9K, with single reflector, 2-pole AMP plug connector with protection cap and 12V55W bulb
1GA 996 361-171	1	FF H3 work light Type of protection: IP5K4K and IPX9K, with single reflector, 2-pole AMP plug connector, vibration damping and 24V70W bulb
1GA 996 461-547	18	FF H3 work light Type of protection: IP5K4K and IPX9K, with single reflector, 600 mm long lead with 2-pole DEUTSCH plug connector, vibration damping and 24V70W bulb
1GA 996 161-581	1	FF H3 work light with single reflector, 2-pole AMP plug connector, vibration damping, mounting bracket for four-point mounting and 24V70W bulb
1GA 996 161-301	1	FF H3 work light with single reflector, 2-pole AMP plug connector and 12V55W bulb
9GH 993 984-001	20	Spare parts/Accessories: Cap for AMP plug connector
8GH 002 090-271	1	H3 bulb,
8GH 002 090-133	1	12V35W
8GH 002 090-251	1	12V55W
8JD 008 151-011	10	24V70W
8KW 701 235-033	100	Socket for AMP plug connector
8KB 990 299-001	1	Blade receptacles, 6.3 mm 2000 mm long connecting lead for AMP plug connector with cap
8HG 990 263-111	1	Mounting bracket for tubular mount on 15 mm - 28 mm dia. pipes
9XD 990 298-031	1	Angular bracket

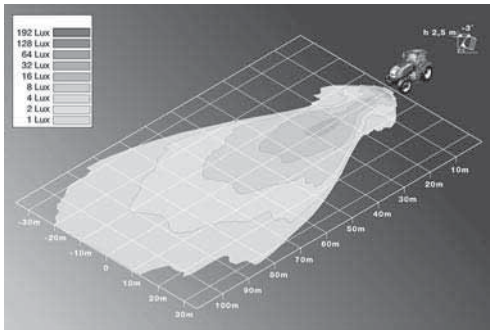

External-fitting work lights

Oval 100 with FF reflector

Lens pattern for extremely wide and long-range illumination. With 2-pole AMP plug connector and protection cap. Light aperture: 130 x 75 mm.

Recommended angle of inclination: 4° - 10°.

Reflector made of die-cast aluminium, glued to hardened glass lens.

Black plastic body with extending edge to protect lens.

Pivot base with M10 fixing screw.

Pivot range vertical 105°. Type of protection: IP5K4K and IPX9K.

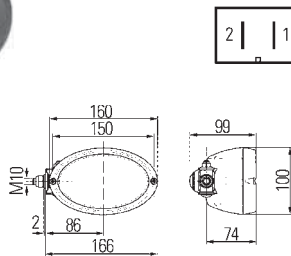
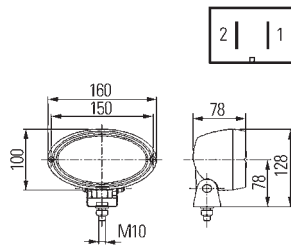

Part no.	Pk.	
1GA 996 161-131	1	FF H3 work light, for upright or pendant mounting, with glass lens without optical pattern, double reflector and 12V55W bulbs
1GA 996 361-011	1	and 24V70W bulbs
1GA 996 161-331	1	FF H3 work light, with side pivot base for left mounting, also suitable for mounting on the right when the unit is turned through 180°, lens without optical pattern, with double reflector and 12V55W bulbs
9GH 993 984-001	20	Spare parts/Accessories: Cap for AMP plug connector
8GH 002 090-271	1	H3 bulb,
8GH 002 090-133	1	12V35W
8GH 002 090-251	1	12V55W
8JD 008 151-011	1	24V70W
8KW 701 235-033	10	Socket for AMP plug connector
8KB 990 299-001	100	Blade receptacles, 6.3 mm
8HG 990 263-111	1	2000 mm long connecting lead for AMP plug connector with cap
9XD 990 298-031	1	Mounting bracket for tubular mount on 15 mm - 28 mm dia. pipes
	1	Angular bracket (except -331)

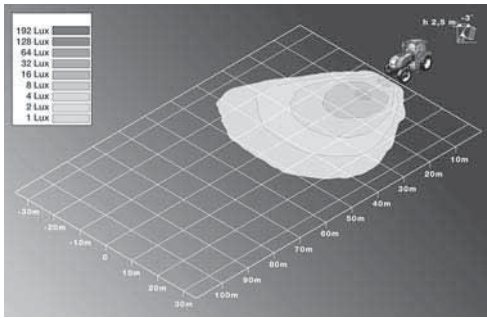

External-fitting work lights for upright mounting

Oval 100 H9 with FF reflector

Lens pattern for wide off-road illumination.
With 12V bulb, accessible from the outside.
Light aperture: 130 x 75 mm.

Recommended angle of inclination: 3° - 10°.
 Reflector made of diecast aluminium, glued to hardened glass lens.
 Black plastic body with extending edge to protect lens.
 Vibration-damped pivot base with bracket for four-point mounting.
 Pivot range vertical 105°.
 With 2000 mm long connecting lead.
 Type of protection: IP5K4K.

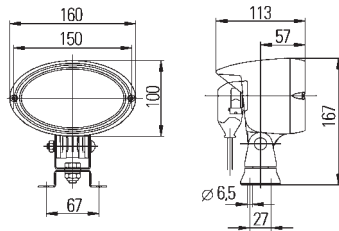

Part no.	Pk.	
1GA 996 161-391	1	FF H9 work light
Spare parts/Accessories:		
8GH 008 357-001	1	H9 bulb, 12V65W
9XD 990 298-001	5	Bracket for four-point fixing
8KB 990 299-311	1	2000 mm long connecting lead, with plug for connecting the H9 bulb
9GH 990 334-011	1	Rubber cap for H9 socket
8HG 990 263-111	1	Mounting bracket for tubular mount on 15 mm - 28 mm dia. pipes

External-fitting work lights for pendant mounting

Lens pattern for close-range illumination.
With 12V bulb, accessible from the outside.
Light aperture: 130 x 75 mm.

Reflector made of die-cast aluminium, glued to hardened glass lens.
 Black plastic body and red lens-retaining rim with extending edge to protect lens.
 Pivot base with M10 fixing screw.
 Type of protection: IP5K9K and IP67.

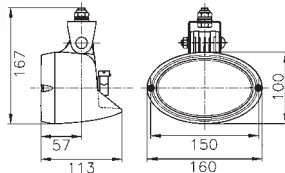

Part no.	Pk.	
1GA 996 561-007	30	FF H9 work light
Spare parts/Accessories:		
8GH 008 357-001	1	H9 bulb, 12V65W
8KB 990 299-311	1	2000 mm long connecting lead, with plug for connecting the H9 bulb
9GH 990 334-011	1	Rubber cap for H9 socket

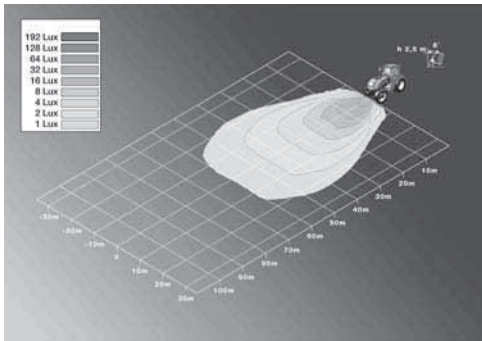

External-fitting work lights

Oval 100 Xenon Integral

Lens pattern for wide, close-range illumination.
With gas discharge bulb and 2-pole DEUTSCH plug connector.
Light aperture: 130 x 75 mm.

Recommended angle of inclination: 8° - 15°.
 Reflector made of die-cast aluminium, glued to hardened glass lens.
 Black plastic body with extending edge to protect lens.
 Xenon-electronic unit 42W integrated into body.
 Without connecting lead (see accessories).
 Pivot range vertical 105°.
 Type of protection: IP5K4K and IPX9K.

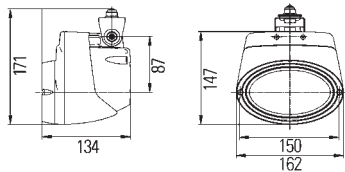
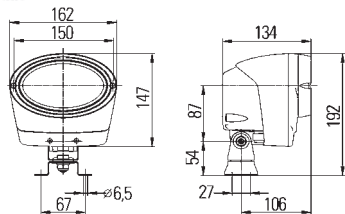

Part no.	Pk.	
1GA 996 261-511	1	Xenon work light with 12V ballast unit, pivot base with bracket for four-point mounting made of stainless steel, for upright mounting
1GA 996 261-521	1	pivot base with M10 fixing screw, for pendant mounting
8GS 009 028-111	1	Spare parts/Accessories: D1S gas discharge bulb, 35W
8KB 990 299-221	1	3700 mm long connecting lead with relay, 15A fuse and DEUTSCH plug connector, 12V
8HG 990 263-111	1	Mounting bracket for tubular mount on 15 mm - 28 mm dia. pipes

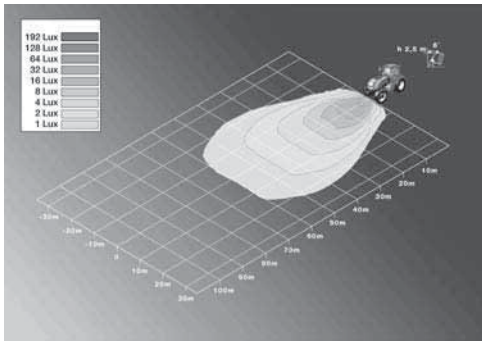

External-fitting work lights

Oval 100 Xenon Integral

Lens pattern for wide close-range illumination.

With gas discharge bulb.

Light aperture: 130 x 75 mm.

Recommended angle of inclination: 8° - 15°.

Reflector made of diecast aluminium, glued to hardened glass lens.

Black plastic body with extending edge to protect lens.

Xenon-electronic unit 42W integrated into body.

Without connecting lead (see accessories).

Pivot range vertical 105°.

Type of protection: IP5K4K and IPX9K.

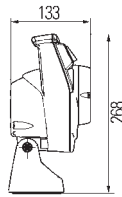
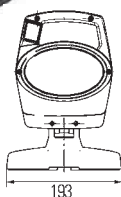
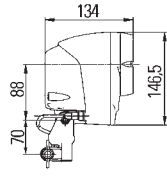
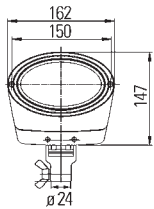
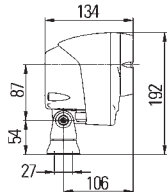
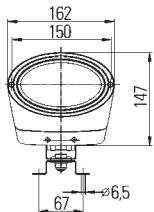

Part no.	Pk.	Description
1GA 996 261-531	1	Xenon work light with 2-pole DEUTSCH plug connector, 24V ballast unit and black lens-retaining rim, pivot base with bracket for four-point mounting made of stainless steel, for upright mounting
1GA 996 261-691	1	for pendant mounting
1GA 996 261-561	1	Xenon work light with pivot base with bracket for four-point mounting made of stainless steel, for upright mounting, with 2-pole AMP plug connector and 12V ballast unit
1GA 996 261-571	1	and 24V ballast unit
1GA 996 261-701	1	Xenon work light with mounting bush for 24 mm dia. standard pin for upright mounting, with 2-pole AMP plug connector and 24V ballast unit
1GA 996 261-711	1	Xenon work light with handle, switch and magnet base for upright mounting, with 2-pole AMP plug connector and 12V ballast unit
8GS 009 028-111	1	Spare parts/Accessories: D1S gas discharge bulb, 35W
8KB 990 299-221	1	3700 mm long connecting lead with relay, 12V
8KB 990 299-231	1	24V
8KB 990 299-121	1	3700 mm long connecting lead with relay, 15A fuse and AMP plug connector, 24V
8JD 008 151-011	10	Socket for AMP plug connector
8KW 701 235-033	100	Blade receptacles, 6.3 mm
8JS 711 687-821	1	Blade-type fuses, 15A (5 pcs.)
8HG 990 263-111	1	Mounting bracket for tubular mount on 15 mm - 28 mm dia. pipes

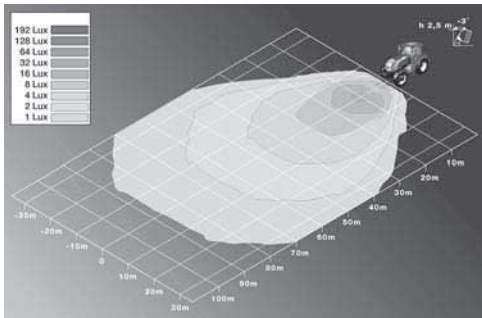

External-fitting work lights for upright mounting

Oval 100 Xenon Integral

Lens pattern for wide off-road illumination.

With gas discharge bulb.

Light aperture: 130 x 75 mm.

Recommended angle of inclination: 3° -10°.

Reflector made of diecast aluminium, glued to hardened glass lens.

Black plastic body with extending edge to protect lens.

Xenon-electronic unit 42W integrated into body.

Without connecting lead (see accessories).

Pivot base with bracket for four-point mounting made of stainless steel.

Pivot range vertical 105°.

Type of protection: IP5K4K and IPX9K.

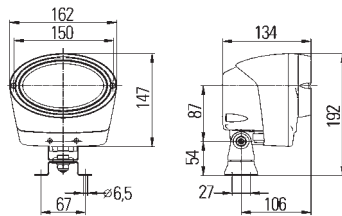

Part no.	Pk.	
1GA 996 261-581	1	Xenon work light with 2-pole AMP plug connector and 12V ballast unit
Spare parts/Accessories:		
8GS 009 028-111	1	D1S gas discharge bulb, 35W
8JD 008 151-011	10	Socket for AMP plug connector
8KW 701 235-033	100	Blade receptacles, 6.3 mm
8HG 990 263-111	1	Mounting bracket for tubular mount on 15 mm - 28 mm dia. pipes

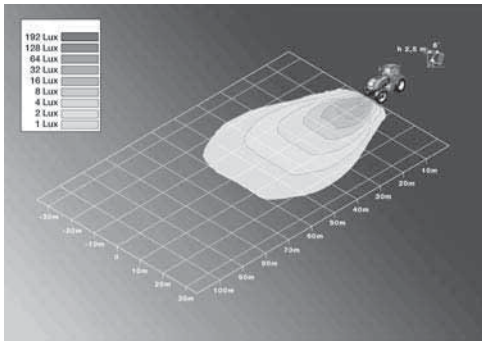

External-fitting work lights

Oval 100 Xenon-Powerpack

Lens pattern for wide close-range illumination.

With gas discharge bulb. Light aperture: 130 x 75 mm.

Recommended angle of inclination: 3° - 10°.

Reflector made of diecast aluminium, glued to hardened glass lens.

Black plastic body with red extending edge to protect lens.

Rear of body made of black diecast aluminium.

Xenon electronic unit integrated into body.

Vibration-damped pivot base with bracket for four-point mounting.

Additionally enclosed, displaceable bracket for single-point attachment.

Type of protection: IP5K4K. System capacity: 42W.

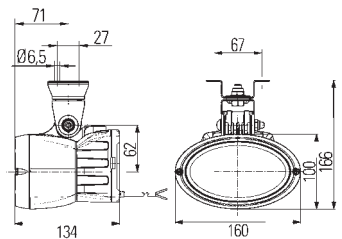
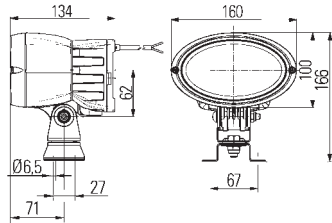

Part no.	Pk.	Description
1GA 996 461-311	1	Xenon work light with 100 mm long lead and 2-pole AMP plug connector, for upright mounting, with 12V ballast unit
1GA 996 461-331	1	with 24V ballast unit
1GA 996 461-787	1	Xenon work light with 300 mm long lead and 2-pole Deutsch plug connector for upright mounting, with 12V ballast unit
1GA 996 461-321	1	Xenon work light with 500 mm long lead and 2-pole AMP plug connector for pendant mounting,
1GA 996 461-341	1	with 24V ballast unit
1GA 996 461-797	1	Xenon work light with 300 mm long lead and 2-pole Deutsch plug connector for pendant mounting, with 12V ballast unit
1GA 996 461-261	1	with 24V ballast unit
8GS 009 028-111	1	Spare parts: D1S gas discharge bulb, 35W

Light series

Oval 100 series - Oval 120 series



External-fitting work lights for upright or pendant mounting

Oval 100 LED

With 8 Power LEDs 25W. Light aperture: 135 x 85 mm.
 2-pole DEUTSCH plug connector integrated.
 High sheen reflector made of plastic glued to Nylon lens.
 Black finish aluminium body with cooling ribs.
 Pivot base with M10 fixing screw.
 Voltage range: 12V - 24V.
 Type of protection: IP6K7 and IP6K9K.

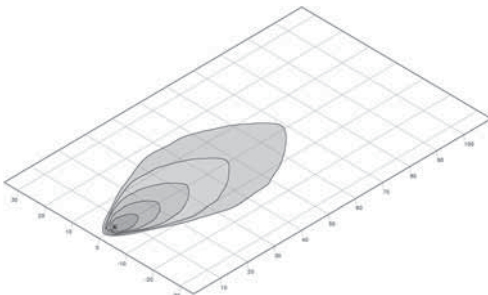
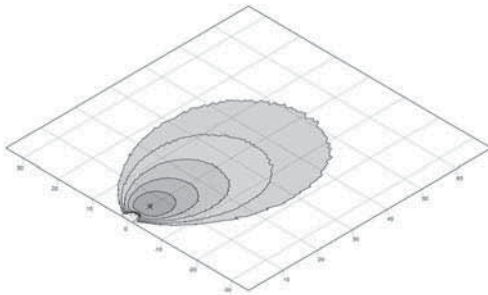
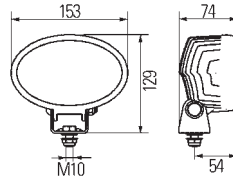

Part no.	Pk.	
1GA 996 661-001	1	LED work light, 1500 lm, with lens pattern for close-range illumination
1GA 996 661-002	1	with lens pattern for close-range illumination, carded
1GA 996 661-011	1	with lens pattern for long-range illumination
8KB 990 299-011	1	Accessories: 2000 mm long connecting lead for DEUTSCH plug connector with cap
9XD 990 298-031	1	Angular bracket

Built-in headlights

Oval 120

With H4 light, 12V-bulb(s) and protection cap.
 Light aperture: 161 x 100 mm.
 Black plastic mounting frame with inclination adjustment 4°.
 Reflector made of plastic, glued to non-patterned glass lens.
 Two M5 x 35 mm fixing screws.

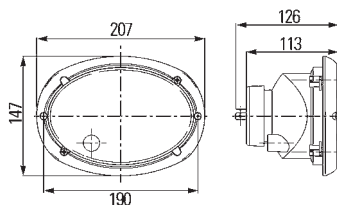

Part no.	Pk.	
1AB 996 157-091	1	H4 built-in headlight with position light
1AB 996 157-081	1	without position light
8GJ 002 525-131	1	Spare parts/Accessories: H4 bulb,
8GJ 002 525-251	1	12V60/55W
8GP 002 067-121	10	24V75/70W
8GP 002 067-241	10	T4W bulb,
9GH 331 480-001	1	12V4W
		24V4W
		Rubber body



1	2
3	4

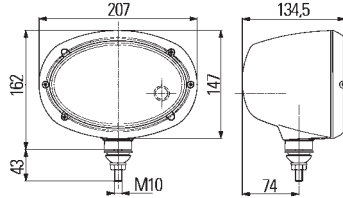

External-fitting headlights for upright mounting

Oval 120

With H4 light and 12V bulb(s).
Light aperture: 161 x 100 mm.

Black plastic body and lens-retaining rim,
with M12 fixing screw.

Part no.	Pk.	
1AB 996 157-151	1	H4 headlight with position light and 4-pole AMP plug connector
1AB 996 157-131	1	without position light, with grommet
Spare parts/Accessories:		
8GJ 002 525-131	1	H4 bulb, 12V60/55W
8GJ 002 525-251	1	24V75/70W T4W bulb,
8GP 002 067-121	10	12V4W
8GP 002 067-241	10	24V4W

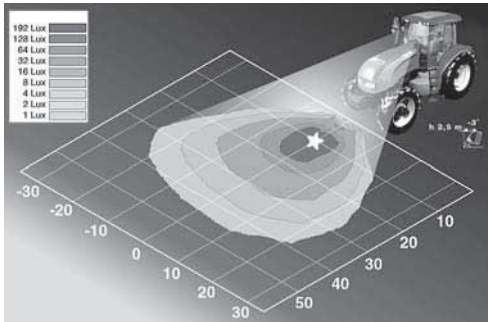

Built-in work lights

Oval 120 Xenon

Lens pattern for off-road illumination.

With gas discharge bulb. Light aperture: 161 x 100 mm.

Recommended angle of inclination: 3° - 10°.

Plastic reflector bonded with lens.

Black plastic mounting frame with inclination adjustment 4°.

With two fixing screws 50 x 35 mm.

The work light is firmly connected to the ballast unit by 500 mm long lead.

Type of protection: IP5K4K.

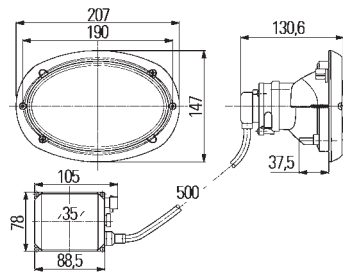

Part no.	Pk.	
1GB 996 158-081	1	Xenon work light with 24V ballast unit
Spare parts:		
5DV 007 810-171	1	Ballast unit, 24V
8GS 007 949-261	1	D2S gas discharge bulb, 35W
8JD 156 151-807	1	Socket set for ballast unit (20 pcs.)

Built-in headlights

Module 6213

With H4 light and protection cap.

Light aperture: 148 x 84 mm.

Lens with steel reflector bonded.

Mounting frame made of black plastic. Inclination 6°.

Mounting area: 148 x 88 mm. Type of protection: IP5K4K.

Only for spare parts requirement.

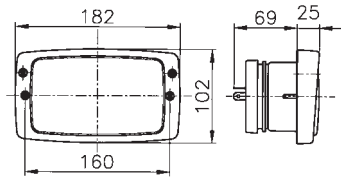

Part no.	Pk.	
1AB 006 213-001	1	H4 built-in headlight without position light, 12V
1AB 006 213-011	1	with position light, 12V
1AB 006 213-027	30	with hardened glass lens and position light, 12V/24V
Spare parts/Accessories:		
9GH 116 966-011	10	Rubber sealing cap
8GJ 002 525-131	1	H4 bulb, 12V60/55W
8GJ 002 525-251	1	24V75/70W T4W bulb,
8GP 002 067-121	10	12V4W
8GP 002 067-241	10	24V4W
9BG 993 345-001	1	Rubber body for sealing installation opening
8JD 008 151-041	10	4-pole socket for AMP plug connector
8KW 701 235-033	100	Blade receptacles, 6.3 mm
9XD 990 298-001	5	Bracket for four-point mounting

With black plastic sealing cap.

Light aperture: 148 x 84 mm.

Plastic reflector bonded with lens.

Mounting frame made of black plastic. Inclination 6°.

Mounting area: 148 x 88 mm. Type of protection: IP5K4K.

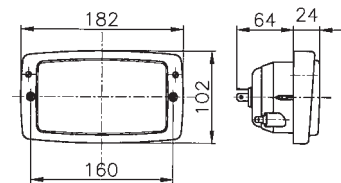

Part no.	Pk.	
1AD 996 018-001	1	R2 built-in headlight with position light, 12V
1AD 996 018-641	1	H4 built-in headlight with position light, 12V/24V
1AD 996 018-651	1	without position light, 12V/24V
Spare parts/Accessories:		
9HD 990 044-001	2	Sealing cap, red
8GD 002 088-141	1	R2 halogen bulb, 12V45/40W
8GJ 002 525-131	1	H4 bulb, 12V60/55W
8GJ 002 525-251	1	24V75/70W T4W bulb,
8GP 002 067-121	10	12V4W
8GP 002 067-241	10	24V4W
8KW 701 235-033	100	Blade receptacles, 6.3 mm

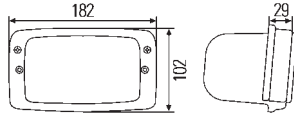

Built-in work lights for horizontal mounting

**Module 6213
Double Beam with FF reflector**

With grommet. Light aperture: 148 x 84 mm.

Double reflector made of diecast aluminium, glued to glass lens. Black plastic body and supporting frame, with pan-head tapping screws made of stainless steel 4.2 x 45 mm.

Distance between screws 160 mm.

Inclination (6° up and downwards) can be adjusted.

Mounting area: 148 x 88 mm.

With 250 mm long connecting lead. Type of protection: IP5K4K.

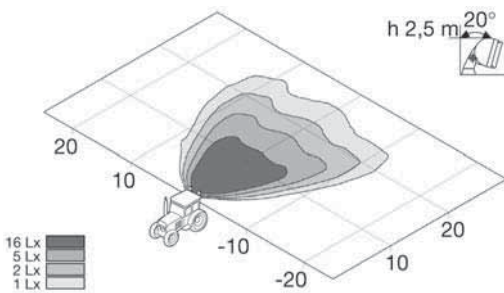
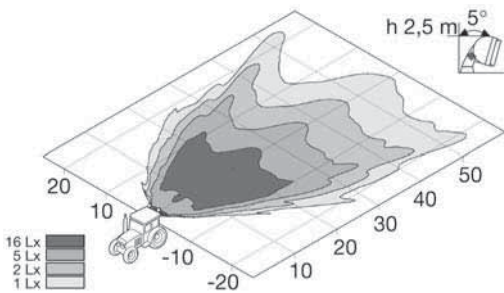
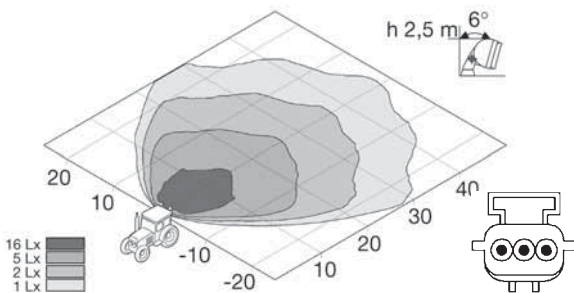
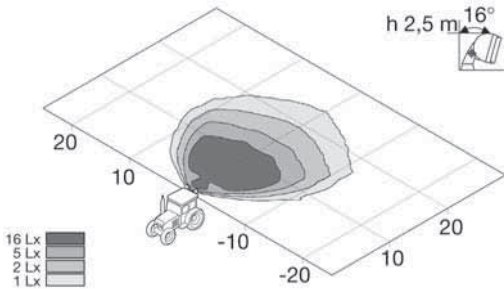

Part no.	Pk.	
1GB 996 080-001	1	FF H3 work light for front or rear flush mounting in vehicle roof. With lens pattern for object illumination for vertical surfaces. Recommended angle of inclination: 15° - 35°, without bulbs
1GB 996 080-011	1	Lens pattern for wide ground illumination. Recommended angle of inclination: 5° - 15°, with 2 bulbs 12V55W
1GB 996 080-107	48	Lens pattern for wide ground illumination. Recommended angle of inclination: 5° - 15°, with 3-pole AMP plug connector and 2 bulbs 12V55W
1GB 996 080-021	1	FF H3 work light for front flush mounting in vehicle roof. Light falling on the engine of the bon net reduced to a minimum in order to avoid dazzling off the driver. Lens pattern for far-reaching off-road illumination. Recommended angle of inclination: 2° - 10°, without bulbs
1GB 996 080-031	1	Lens pattern for ground illumination. Recommended angle of inclination: 20° - 30°, without bulbs
		Spare parts/Accessories:
8GH 002 090-271	1	H3 bulb, 12V35W
8GH 002 090-133	1	12V55W
8GH 002 090-251	1	24V70W
9BG 993 345-001	1	Rubber body for sealing installation opening
8JD 008 151-041	10	4-pole socket for AMP plug connector
8KW 701 235-033	100	Blade receptacles, 6.3 mm

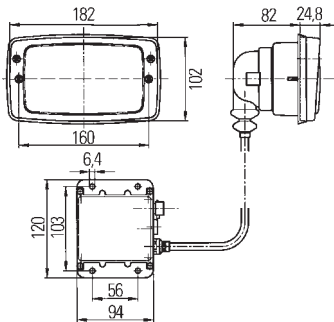

Built-in work lights

Module 6213-Xenon

With 12V ballast unit and gas discharge bulb.

Light aperture: 148 x 84 mm.

Recommended angle of inclination: 10° - 20°.

Plastic reflector bonded with lens.

With pan-head tapping screws made of stainless steel 4.2 x 45 mm.

Inclination (6° up and downwards) can be adjusted.

Rubber body for sealing installation opening 148 x 88 mm.

The ballast unit is firmly connected to work light by a 300 mm long lead.

Type of protection: IP5K4K.

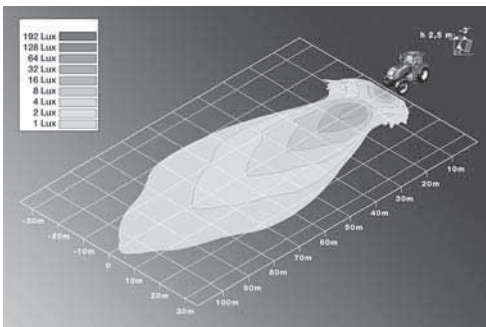
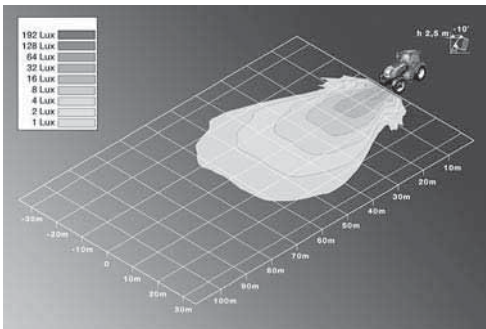

Part no.	Pk.	
1GB 996 147-011	1	Xenon work light with 3700 mm long connection lead, relay and 15A fuse, with red supporting frame and lens pattern for large area illumination
1GB 996 147-101	1	without connection lead, with black supporting frame and lens pattern for long-range illumination
8GS 007 949-261	1	Spare parts/Accessories: D2S gas discharge bulb, 35W Blade-type fuses, 15A (5 pcs.) 3000 mm long connection lead from ballast unit to battery, with relay and fuse, 12V
8JS 711 687-821	1	
8KB 149 147-001	1	

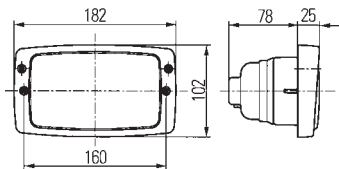
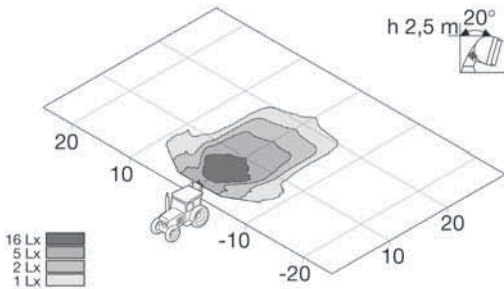
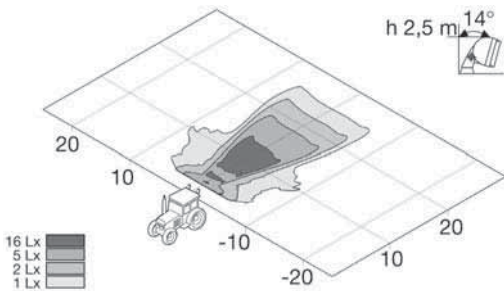

Built-in work lights

Module 6213

Light aperture: 148 x 84 mm.

Recommended angle of inclination: 10° - 20°.

Lens with metal reflector bonded.

Black plastic supporting frame with pan-head tapping screws made of stainless steel 4.2 x 45 mm.

Inclination (6° up and downwards) can be adjusted.

Mounting area: 148 x 88 mm. Type of protection: IP5K4K.

Part no.	Pk.	
1GB 006 213-101 1GB 006 213-107	1 30	H3 work light, 12V/24V, with reflector made of sheet metal and lens pattern for long-range illumination
1GB 006 213-111 1GB 006 213-117	1 30	lens pattern for close-range illumination
1GD 996 018-541	1	H3 work light, 12V/24V, with reflector made of plastic and lens pattern for close-range illumination
8GH 002 090-271 8GH 002 090-133 8GH 002 090-251	1 1 1	Accessories: H3 bulb, 12V35W 12V55W 24V70W Rubber body for sealing installation opening, for -101/-107/-111/-117
9BG 993 345-001 9BG 990 042-061	1 1	for -541 4-pole socket for AMP plug connector
8JD 008 151-041 8KW 701 235-033	10 100	Blade receptacles, 6.3 mm

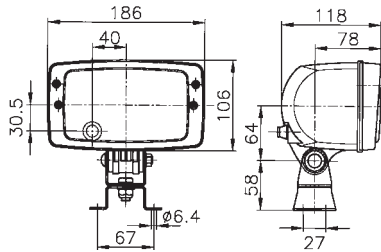

External-fitting headlights for upright or pendant mounting

Module 6213

With H4 light and position light.

With grommet. Light aperture: 148 x 84 mm.

Reflector made of sheet steel, glued to glass lens.

Black plastic body and lens-retaining rim.

Pivot base with bracket for four-point mounting.

Part no.	Pk.	
1AB 996 213-001	1	H4 headlight
Spare parts/Accessories:		
1AB 006 213-011	1	Light unit with lens-retaining rim
9XD 990 298-001	5	Bracket for four-point fixing
8GJ 002 525-131	1	H4 bulb,
8GJ 002 525-251	1	12V60/55W
		24V75/70W
		T4W bulb,
8GP 002 067-121	10	12V4W
8GP 002 067-241	10	24V4W

External-fitting work lights for upright or pendant mounting

Lens pattern for close-range illumination.

With grommet and vibration damping.

Light aperture: 148 x 84 mm.

Recommended angle of inclination: 10° - 20°.

Lens with metal reflector bonded.

Black plastic body and lens-retaining rim.

Pivot base with bracket for four-point mounting.

Type of protection: IP5K4K.

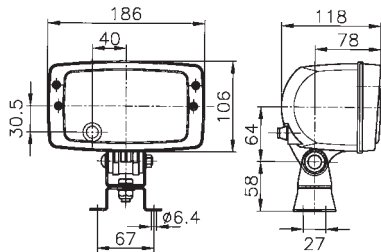
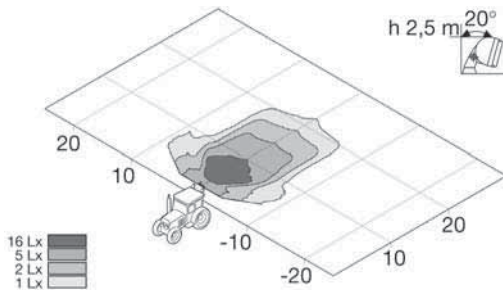

Part no.	Pk.	
1GB 996 213-511	1	H3 work light
Spare parts/Accessories:		
1GB 006 213-111	1	Light unit with lens-retaining rim
9XD 990 298-001	5	Bracket for four-point fixing
8GH 002 090-271	1	H3 bulb,
8GH 002 090-133	1	12V35W
8GH 002 090-251	1	12V55W
		24V70W

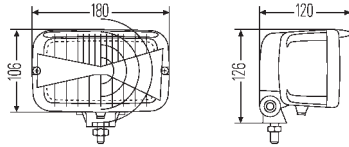

External-fitting headlights for upright or pendant mounting

7145

With H4 light and position light.

Light aperture: 148 x 84 mm.

Reflector made of sheet metal, glued to glass lens.

Body and mounting frame made of black plastic.

Pivot base with M10 fixing screw.

Part no.	Pk.	
1AB 007 145-001	1	H4 headlight
1AB 007 145-007	36	
Accessories:		
8GJ 002 525-131	1	H4 bulb, 12V60/55W
8GP 002 067-121	10	T4W bulb, 12V4W

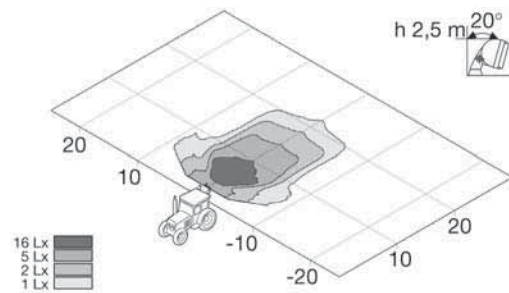

External-fitting work lights for upright or pendant mounting

Lens pattern for ground illumination.

Light aperture: 148 x 84 mm.

Recommended angle of inclination: 10° - 20°.

Reflector made of sheet metal, glued to glass lens.

Black plastic body and lens-retaining rim.

Pivot base with M10 fixing screw

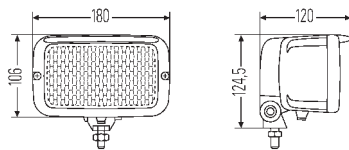

Part no.	Pk.	
1GB 007 145-101	1	H3 work light
1GB 007 145-107	36	
Accessories:		
		H3 bulb,
8GH 002 090-271	1	12V35W
8GH 002 090-133	1	12V55W
8GH 002 090-251	1	24V70W

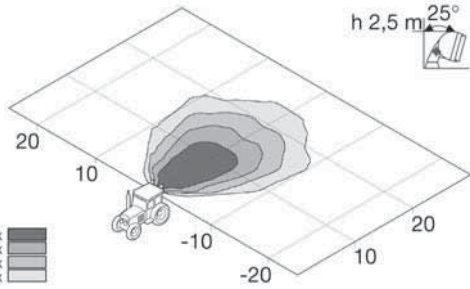

External-fitting work lights for upright or pendant mounting

Double-Beam with FF reflector

Lens pattern for intensive close-range illumination.

With grommet. Light aperture: 136 x 88 mm.

Recommended angle of inclination: 25° - 35°.

Double reflector made of diecast aluminium, glued to glass lens.

Black plastic body with extending edge to protect lens.

With 250 mm long silicone connection lead.

Pivot base with bracket for four-point mounting.

Without vibration damping. Type of protection: IP5K4K.

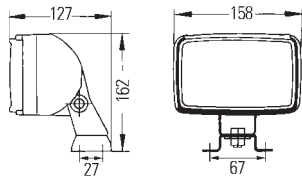
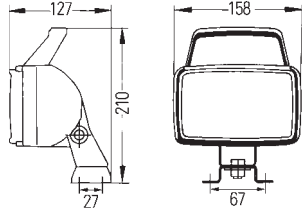

Part no.	Pk.	
1GA 006 991-021	1	FF H3 work light with handle
1GA 006 991-091	1	without handle
Spare parts/Accessories:		
1GA 998 524-001	1	Light unit
9XD 990 298-001	5	Bracket for four-point fixing
8GH 002 090-271	1	H3 bulb, 12V35W
8GH 002 090-133	1	H3 bulb, 12V55W
8GH 002 090-251	1	H3 bulb, 24V70W

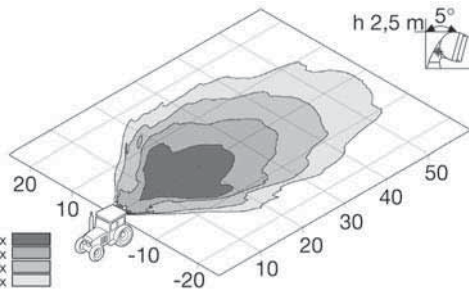

Lens pattern for far-reaching off-road illumination.

With grommet. Light aperture: 136 x 88 mm.

Recommended angle of inclination: 5° - 15°.

Double reflector made of diecast aluminium, glued to glass lens.

Black plastic body with extending edge to protect lens.

With 250 mm long silicone connection lead.

Pivot base with bracket for four-point mounting.

Without vibration damping. Type of protection: IP5K4K.

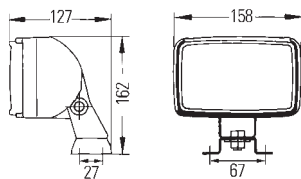
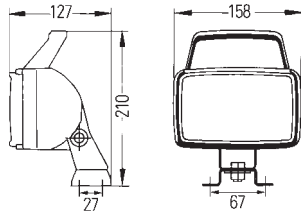

Part no.	Pk.	
1GA 006 991-061	1	FF H3 work light with handle
1GA 006 991-051	1	without handle
Spare parts/Accessories:		
9XD 990 298-001	5	Bracket for four-point fixing
8GH 002 090-271	1	H3 bulb, 12V35W
8GH 002 090-133	1	H3 bulb, 12V55W
8GH 002 090-251	1	H3 bulb, 24V70W

External-fitting work lights for upright or pendant mounting

Double-Beam with FF reflector

Lens pattern for wide ground illumination.
With grommet. Light aperture: 136 x 88 mm.

Recommended angle of inclination: 15° - 25°.
 Double reflector made of diecast aluminium, glued to glass lens.
 Black plastic body with extending edge to protect lens.
 With 250 mm long silicone connection lead.
 Pivot base with bracket for four-point mounting.
 Without vibration damping. Type of protection: IP5K4K.

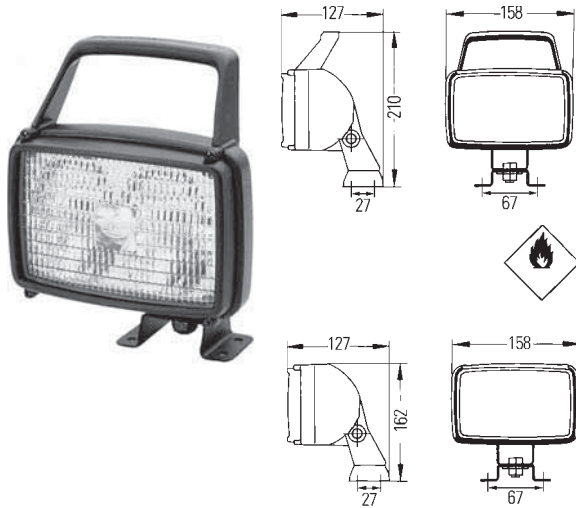
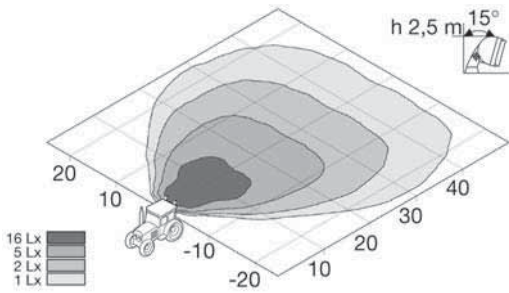

Part no.	Pk.	
1GA 006 991-031	1	FF H3 work light with handle
1GA 006 991-041	1	without handle
9XD 990 298-001	5	Spare parts/Accessories: Bracket for four-point fixing
8GH 002 090-271	1	H3 bulb, 12V35W
8GH 002 090-133	1	12V55W
8GH 002 090-251	1	24V70W

Lens pattern for object illumination for vertically surfaces.
With grommet. Light aperture: 136 x 88 mm.

Recommended angle of inclination:
 for vertically surfaces 0° - 5°, for horizontally surfaces 25° - 45°.
 Double reflector made of diecast aluminium, glued to glass lens.
 Black plastic body with extending edge to protect lens.
 With 250 mm long silicone connection lead.
 Pivot base with bracket for four-point mounting.
 Without vibration damping. Type of protection: IP5K4K.

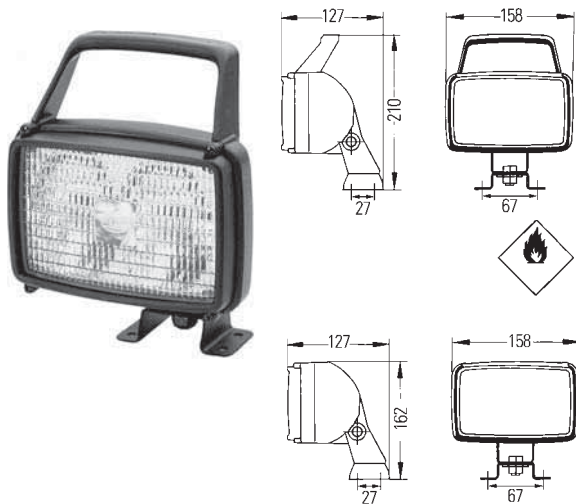
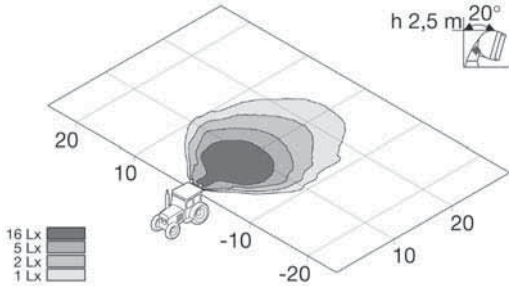

Part no.	Pk.	
1GA 006 991-081	1	FF H3 work light with handle
1GA 006 991-071	1	without handle
9XD 990 298-001	5	Spare parts/Accessories: Bracket for four-point fixing
8GH 002 090-271	1	H3 bulb, 12V35W
8GH 002 090-133	1	12V55W
8GH 002 090-251	1	24V70W

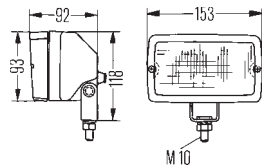
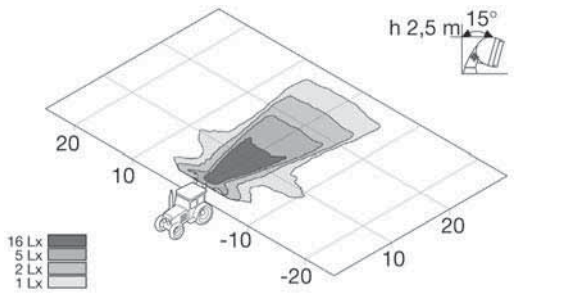

Work lights

Master 5060

Lens pattern for long-range illumination.
With grommet. Light aperture: 135 x 75 mm.
 Recommended angle of inclination: 15° - 20°.
 Reflector made of sheet steel, glued to glass lens.
 Black plastic body with extending edge to protect lens.
 Type of protection: IP5K4K.

Part no.	Pk.	
1GA 005 060-001	1	H3 work light with pivot base with M10 fixing screw for upright or pendant mounting
Spare parts:		
1GA 132 459-011	1	Light unit
8GH 002 090-271	1	H3 bulb, 12V35W
8GH 002 090-133	1	12V55W
8GH 002 090-251	1	24V70W

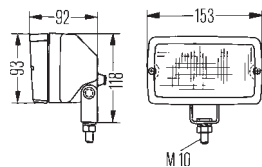
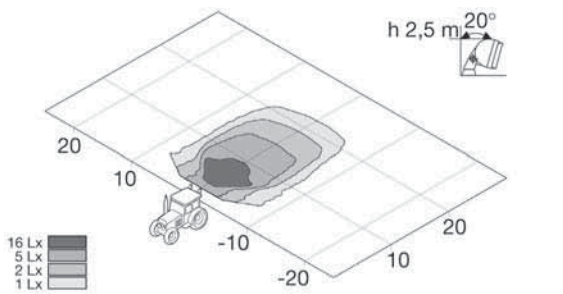

Lens pattern for close-range illumination.
With grommet. Light aperture: 135 x 75 mm.
 Recommended angle of inclination: 15° - 20°.
 Reflector made of sheet steel, glued to glass lens.
 Black plastic body with extending edge to protect lens.
 Type of protection: IP5K4K.

Part no.	Pk.	
1GA 005 060-041	1	H3 work light with pivot base with M10 fixing screw for upright or pendant mounting
H3 built-in work light with 2 fixing screws 3.5 x 25 mm and 12V55W bulb. Mounting area: 152 x 92 mm		
1GA 005 060-337	30	
Spare parts/Accessories:		
8GH 002 090-271	1	H3 bulb, 12V35W
8GH 002 090-133	1	12V55W
8GH 002 090-251	1	24V70W

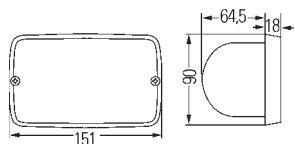

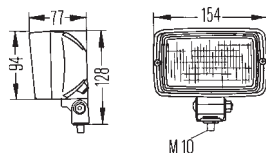
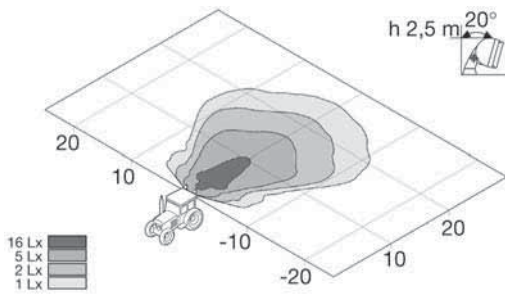

External-fitting work lights for upright or pendant mounting

Picador 6876 with FF reflector

Lens pattern for ground illumination.

With grommet. Light aperture: 125 x 75 mm.

Recommended angle of inclination: 20° - 25°.

Plastic reflector bonded with lens.

Black plastic body and lens-retaining rim.

Lens-retaining rim with extending edge to protect lens.

Universal bracket with M10 fixing screw.

Pivot range: horizontal 130°, vertical 90°. Type of protection: IP5K4K.

Part no.	Pk.	
1GA 006 876-001	1	FF H3 work light with rotary pivot base
		Spare parts/Accessories:
		H3 bulb,
8GH 002 090-271	1	12V35W
8GH 002 090-133	1	12V55W
8GH 002 090-251	1	24V70W
		Mounting bracket for tubular mount on
8HG 990 263-111	1	15 mm - 28 mm dia. pipes
8HG 004 806-001	1	Magnet bracket
9XD 130 261-001	5	Bracket for four-point fixing

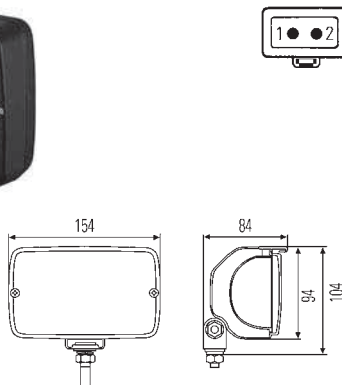
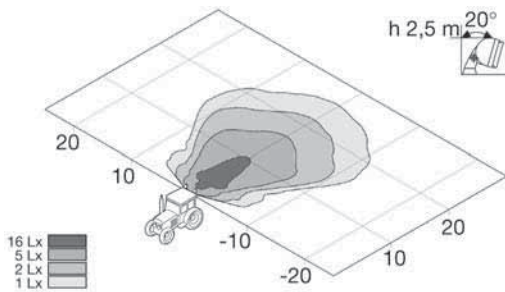

Picador 8522 with FF reflector

Lens pattern for ground illumination.

Light aperture: 125 x 75 mm.

Recommended angle of inclination: 20° - 25°.

Plastic reflector bonded with lens.

Black plastic body and lens-retaining rim.

Lens-retaining rim with extending edge to protect lens.

Universal bracket with M10 fixing screw

Pivot range: horizontal 130°. Type of protection: IP5K4K.

Part no.	Pk.	
1GA 998 522-011	1	FF H3 work light with pivot base and grommet, without bulb
		with pivot base, 12V55W bulb, 150 mm long lead and 2-pole DEUTSCH plug connector
1GA 998 522-407	350	
		Spare parts/Accessories:
		H3 bulb,
8GH 002 090-271	1	12V35W
8GH 002 090-133	1	12V55W
8GH 002 090-251	1	24V70W
		Mounting bracket for tubular mount on
8HG 990 263-111	1	15 mm - 28 mm dia. pipes
8HG 004 806-001	1	Magnet bracket
9XD 130 261-001	5	Bracket for four-point fixing

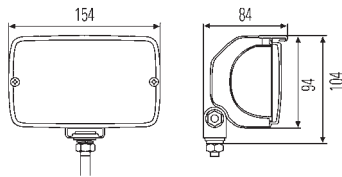
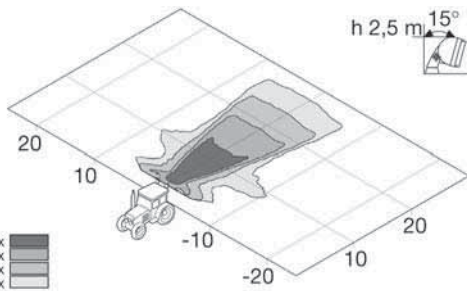

External-fitting work lights for upright or pendant mounting

Picador 6876 with FF reflector

Lens pattern for long-range illumination.
 Recommended angle of inclination: 15° - 20°.
 Plastic reflector bonded with lens.
 Black plastic body and lens-retaining rim.
 Lens-retaining rim with extending edge to protect lens.
 Universal bracket with M10 fixing screw
 Pivot range: horizontal 130°. Type of protection: IP5K4K.

Part no.	Pk.	
1GB 996 102-101	1	FF H3 work light with pivot base
		Spare parts/Accessories:
		H3 bulb,
8GH 002 090-271	1	12V35W
8GH 002 090-133	1	12V55W
8GH 002 090-251	1	24V70W
8HG 990 263-111	1	Mounting bracket for tubular mount on 15 mm - 28 mm dia. pipes
8HG 004 806-001	1	Magnet bracket
9XD 130 261-001	5	Bracket for four-point fixing

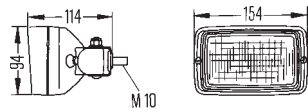
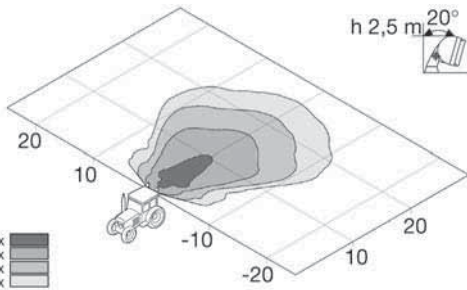

External-fitting work lights

Picador 6875 with FF reflector

Lens pattern for ground illumination.
With grommet. Light aperture: 125 x 75 mm.
 Recommended angle of inclination: 20° - 25°.
 Plastic reflector bonded with lens.
 Black plastic body and lens-retaining rim.
 Lens-retaining rim with extending edge to protect lens.
 Universal side bracket with M10 mounting screw for attachment to vertical surfaces.
 Pivot range: horizontal 150°, vertical 90°. Type of protection: IP5K4K.

Part no.	Pk.	
1GA 006 875-001	1	FF H3 work light with side rotary pivot base
		Spare parts:
		H3 bulb,
8GH 002 090-271	1	12V35W
8GH 002 090-133	1	12V55W
8GH 002 090-251	1	24V70W

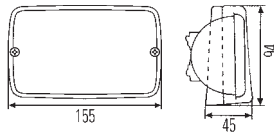
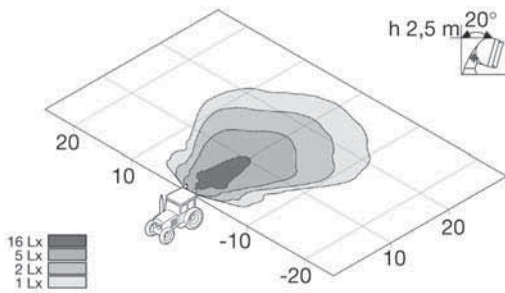

Built-in work lights

Picador 6082 with FF reflector

Lens pattern for ground illumination.

Light aperture: 125 x 75 mm.

Recommended angle of inclination: 20° - 25°.

Plastic reflector bonded with lens.

Black plastic lens-retaining rim.

Lens-retaining rim with extending edge to protect lens.

With two 3.9 x 55 mm fixing screws. Distance between screws: 142 mm.

Foam rubber seal for sealing dust and water-tight to outside on

even attachment surfaces. Front inclination 5.2°.

Mounting aperture: 130 x 76 mm. Type of protection: IP5K4K.

Part no.	Pk.	
1GA 996 082-001	1	FF H3 work light
Accessories:		
		H3 bulb,
8GH 002 090-271	1	12V35W
8GH 002 090-133	1	12V55W
8GH 002 090-251	1	24V70W

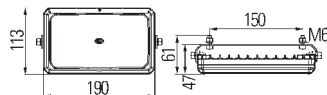
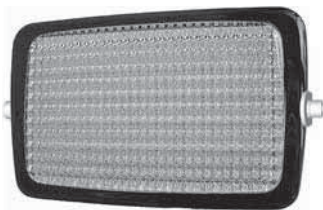
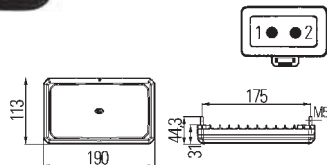
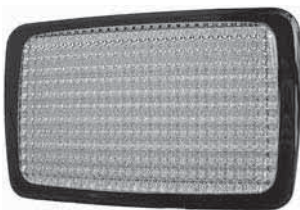
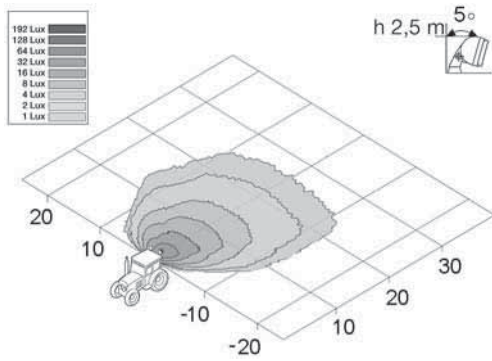

External-fitting work lights

Flatbeam LED

Lens pattern for close-range illumination.

Light aperture: 165 x 90 mm.

With 60 LEDs, 1000 lm.

Plastic body and reflector.

Plastic lens without optical pattern.

Voltage range: 12V - 24V, 11W.

Part no.	Pk.	
1GD 996 193-001	1	LED work light with two M5 fixing screws and 2000 mm long lead
1GD 996 193-051	1	with 45° optic, two M5 fixing screws and 2000 mm long lead
1GD 996 193-071	1	with two M5 fixing screws and 250 mm long lead with 2-pole DEUTSCH plug connector
1GD 996 193-011	1	with swivel bracket, two M6 fixing screws and 2000 mm long lead

External-fitting work lights

Light aperture: 172 x 86 mm.
Black plastic body.
For Fendt.

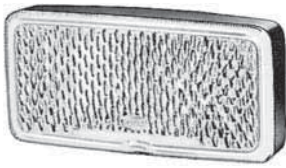

Part no.	Pk.	
1GD 003 690-287	1	H3 work light
Accessories:		
		H3 bulb,
8GH 002 090-271	1	12V35W
8GH 002 090-133	1	12V55W
8GH 002 090-251	1	24V70W

External-fitting work lights for upright or pendant mounting

Torero 5700

Lens pattern for close-range illumination.
Light aperture: 195 x 96 mm.
Recommended angle of inclination: 15° - 25°.
Reflector made of sheet metal, glued to glass lens.
Black plastic body.
Pivot base with M10 fixing screw.
Type of protection: IP5K4K.

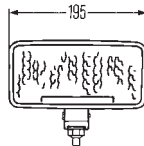
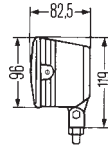
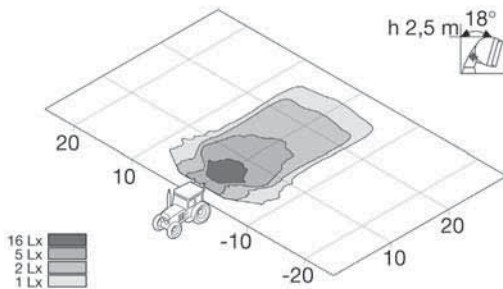

Part no.	Pk.	
1GD 005 700-501	1	H3 work light
Spare parts/Accessories:		
		H3 bulb,
8GH 002 090-271	1	12V35W
8GH 002 090-133	1	12V55W
8GH 002 090-251	1	24V70W

3590

Lens pattern for close-range illumination.
With grommet. Light aperture: 195 x 96 mm.
Black plastic body.
Pivot base with M10 fixing screw.
Type of protection: IP5K4K.
For Bomag and John Deere.

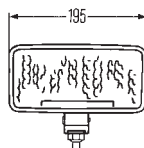
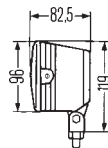
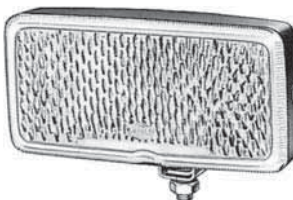
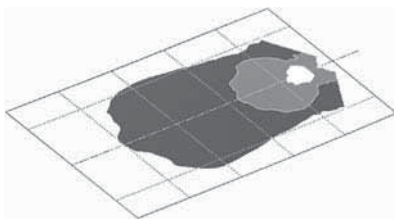

Part no.	Pk.	
1GD 003 590-701	1	H3 work light
Spare parts/Accessories:		
		H3 bulb,
8GH 002 090-271	1	12V35W
8GH 002 090-133	1	12V55W
8GH 002 090-251	1	24V70W



External-fitting work lights for upright or pendant mounting

ETL 250

With 12 LEDs 3,0W and 2500 mm long lead with polarity reversal protection.
Light aperture: 130 x 45 mm.

Reflector made of plastic, glued to plastic lens.
Black plastic body.
Bracket made of stainless steel with two holes 6.5 mm dia. for fixing screws.
Voltage range: 9V - 33V, 3,0W. Type of protection: IP6K7.

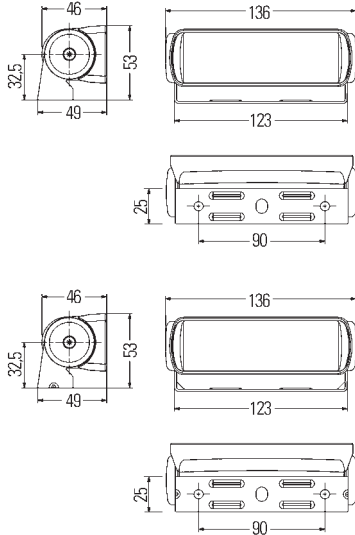

Part no.	Pk.	
1GA 980 670-231	1	LED work light, 250 lm, with lens pattern for close-range illumination
1GA 980 670-331	1	with lens pattern for object illumination

External-fitting or built-in work lights

Oval 90 HB3

Lens pattern for close-range illumination.
With 12V bulb. Light aperture: 130 x 75 mm.

Recommended angle of inclination: 3° - 10°.
Reflector made of diecast aluminium, glued to hardened glass lens.
Black plastic body.
Type of protection: IP6K9K.

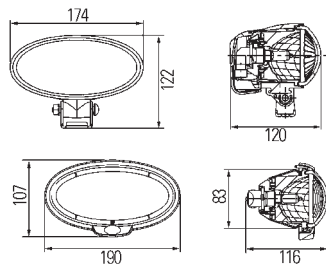
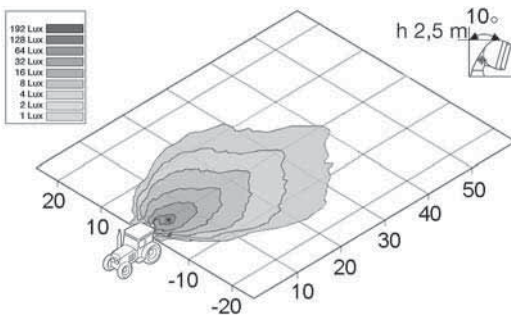

Part no.	Pk.	
1GB 996 186-051	1	HB3 work light with U-bracket and 10.2 mm dia hole for fixing screw, for upright mounting
1GB 996 186-061	1	with clamp fixing for flush mounting
8KB 990 299-331	1	Spare parts: 2000 mm long connecting lead, with plug for connecting the HB3 bulb

External-fitting work lights for upright or pendant mounting

Oval 90 LED

With 10 Power LEDs. Light aperture: 130 x 75 mm.
 2-pole DEUTSCH plug connector integrated.
 High sheen reflector made of plastic glued to Nylon lens.
 Black finish aluminium body with cooling ribs.
 Pivot base with M8 fixing screw.
 Voltage range: 12V - 24V, 28W.
 Type of protection: IP6K7 and IP6K9K.

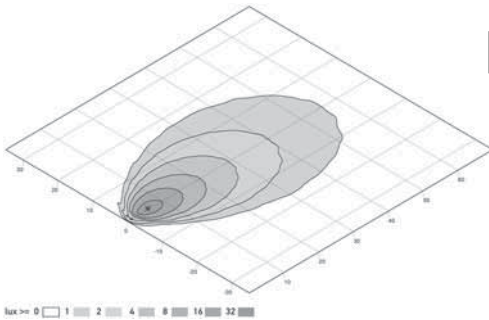
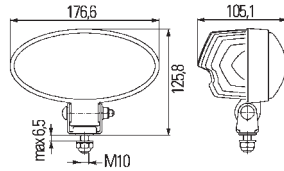

1GB 996 386-001

1

LED work light, 1700 lm, with lens pattern for close-range illumination

1GB 996 386-002

1

with lens pattern for close-range illumination, carded

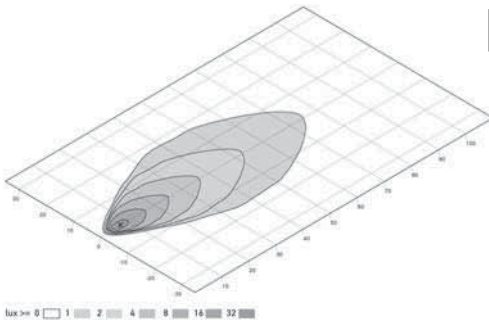

1GB 996 386-021

1

with lens pattern for long-range illumination

External-fitting work lights

ECO 21

Lens pattern for close-range illumination
 Light aperture: 88 x 88 mm.
 Plastic reflector bonded with lens.
 Black plastic body.
 Pivot base with M10 fixing screw.
 With 200 mm connection lead.
 Bulb accessible from the outside.
 Type of protection: IP5K9K.

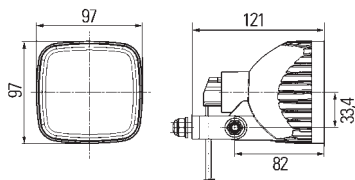

Part no.

Pk.

1GA 996 179-021

1

P21W work light with 12V bulb

1GA 996 179-001

1

with 24V bulb

8GA 002 073-121

10

Spare parts:
 P21W bulb,
 12V

8GA 002 073-241

10

24V

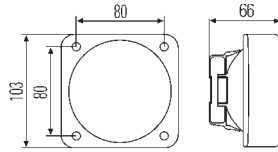

Built-in work lights

For installation on side next to headlight.
With 12V55W bulb.

For illumination to front and side.
With four 3.9 x 13 fixing screws.

Part no.	Pk.	
1GA 996 020-001	1	H3 work light
Spare parts/Accessories:		
		H3 bulb,
8GH 002 090-271	1	12V35W
8GH 002 090-133	1	12V55W

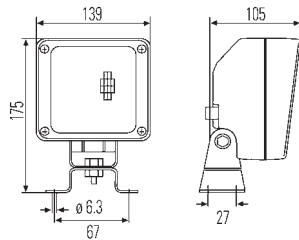

External-fitting work lights for upright, pendant or side mounting

AS 200 with FF reflector

With 2-pole AMP plug connector and protection cap.
Light aperture: 123 x 123 mm.

Black plastic body and lens-retaining rim.
Lens-retaining rim with extending edgeto protect lens.
Vibration-damped pivot base with bracket
for four-point mounting.
Type of protection: IP5K4K.

Part no.	Pk.	
1GA 998 532-011	1	FF H3 work light, recommended angle of inclination: 15° - 25°, with lens pattern for ground illumination
1GA 998 532-081	1	recommended angle of inclination: 5°, with lens pattern for long-range illumination
Spare parts/Accessories:		
8HG 990 263-111	1	Mounting bracket for tubular mount on 15 mm - 28 mm dia. pipes
		H3 bulb,
8GH 002 090-271	1	12V35W
8GH 002 090-133	1	12V55W
8GH 002 090-251	1	24V70W
8KB 990 299-001	1	2000 mm long connecting lead for AMP plug connector with cap
8JD 008 151-011	10	Socket for AMP plug connector
8KW 701 235-033	100	Blade receptacles, 6.3 mm
9GH 993 984-001	20	Cap for AMP plug connector

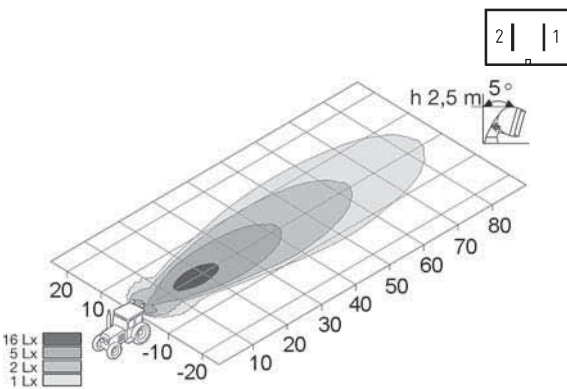
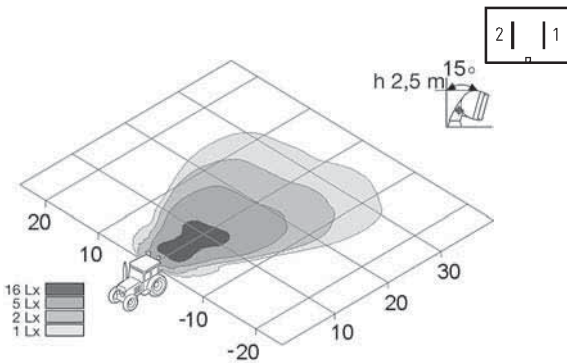

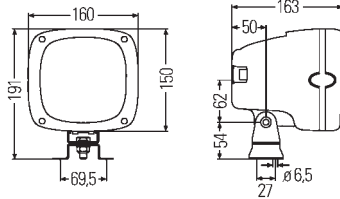
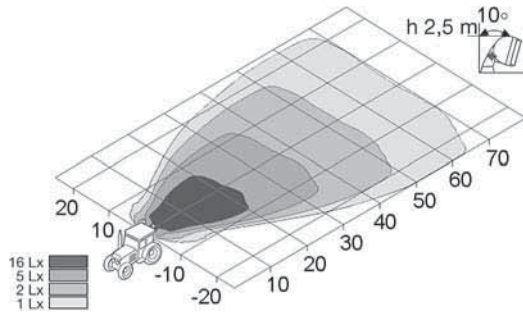

External-fitting work lights

AS 200 Xenon

Lens pattern for wide close-range illumination.

With gas discharge bulb. Light aperture: 123 x 123 mm.

Recommended angle of inclination: 10° - 25°.

Plastic reflector bonded with lens.

Black plastic body with extending edge to protect lens.

With red decorative ring. Handle recessed into body.

Xenon electronic unit 42W integrated into body.

Pivot base with bracket for four-point mounting.

Type of protection: IP5K4K and IPX9K.

Part no.	Pk.	
1GA 996 142-001	1	Xenon work light with 12V ballast unit, 2-pole AMP plug connector and 3100 mm long connecting lead with relay and fuse
1GA 996 142-011	1	with 24V ballast unit, 2-pole AMP plug connector and 3100 mm long connecting lead with relay and fuse
1GA 996 142-021	1	with 12V ballast unit, 2-pole DEUTSCH plug connector and 3100 mm long connecting lead with relay and fuse
1GA 996 142-311	1	with 24V ballast unit, 2-pole DEUTSCH plug connector and black decorative ring, without connecting lead
1GA 990 305-061	1	Spare parts/Accessories: Light unit (D1S) 7/2011->
1GA 990 305-001	1	Light unit (D2S) ->6/2011
5DV 010 286-001	1	Ballast unit, 12V
5DV 010 286-011	1	24V
8GS 009 028-111	1	D1S gas discharge bulb, 35W
8GS 007 949-261	1	D2S gas discharge bulb, 35W
9GH 993 984-001	20	Cap for AMP plug connector
8KB 990 299-121	1	3700 mm long connecting lead with relay, 15A fuse and AMP plug connector, 24V
8KB 990 299-221	1	3700 mm long connecting lead with relay and fuse for DEUTSCH plug connector, 12V
8KB 990 299-231	1	24V
8JS 711 687-821	1	Blade-type fuses, 15A (5 pcs.)
8JD 008 151-011	10	Socket for AMP plug connector
8KW 701 235-033	100	Blade receptacles, 6.3 mm
8HG 990 320-001	1	Bracket attachment foot
8HG 990 263-111	1	Mounting bracket for tubular mount on 15 mm - 28 mm dia. pipes

External-fitting work lights for upright mounting

AS 200 Xenon

Lens pattern for wide close-range illumination.
With gas discharge bulb. Light aperture: 123 x 123 mm.
 Recommended angle of inclination: 10° - 50°.
 Plastic reflector bonded with lens.
 Black plastic body with extending edge to protect lens.
 With red decorative ring. Handle recessed into body.
 Xenon electronic unit 42W integrated into body.
 Type of protection: IP5K4K and IPX9K.

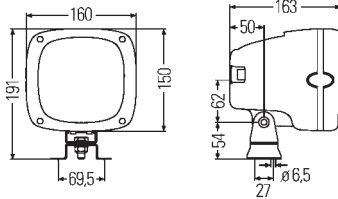
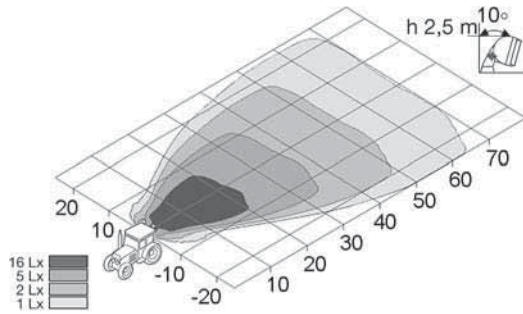

Part no.	Pk.	
1GA 996 142-141	1	Xenon work light with 24V ballast unit, PG-screwed connections and 3000 mm long connecting lead, without relay and fuse, sealed type, with pivot base with bracket
1GA 996 142-371	1	with 24V ballast unit, PG-screwed connections and 4500 mm long connecting lead, without relay and fuse, sealed type, with pivot base with bracket
Spare parts/Accessories:		
1GA 990 305-061	1	Light unit (D1S) 7/2011->
1GA 990 305-001	1	Light unit (D2S) ->6/2011
5DV 010 286-011	1	Ballast unit, 24V
8GS 009 028-111	1	D1S gas discharge bulb, 35W
8GS 007 949-261	1	D2S gas discharge bulb, 35W

External-fitting work lights

Lens pattern for wide close-range illumination.
With gas discharge bulb. Light aperture: 123 x 123 mm.
 Recommended angle of inclination: 10° - 25°.
 Plastic reflector bonded with lens.
 Black plastic body with extending edge to protect lens.
 With red decorative ring. Handle recessed into body.
 Xenon electronic unit 42W integrated into body.
 Pivot base with bracket for four-point mounting.
 Type of protection: IP5K4K and IPX9K.

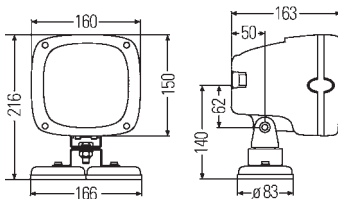
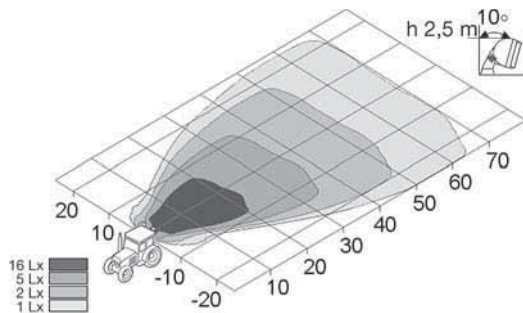

Part no.	Pk.	
1GA 996 142-041	1	Xenon work light with 12V ballast unit, magnet holder, PG-screw connection and 2500 mm long connection lead with plug 8JA 001 915-001. (Suitable sockets in compliance with DIN 4165)
Spare parts/Accessories:		
1GA 990 305-061	1	Light unit (D1S) 7/2011->
1GA 990 305-001	1	Light unit (D2S) ->6/2011
5DV 010 286-001	1	Ballast unit, 12V
8GS 009 028-111	1	D1S gas discharge bulb, 35W
8GS 007 949-261	1	D2S gas discharge bulb, 35W
8HG 004 806-001	1	Magnet holder with fixing material
9XD 130 261-001	5	Mounting bracket for magnet holder
8JS 711 687-821	1	Blade-type fuses, 15A (5 pcs.)
8JA 001 915-001	10	Plug, 2-pole

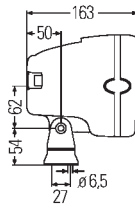
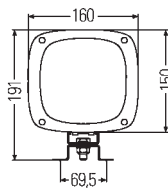
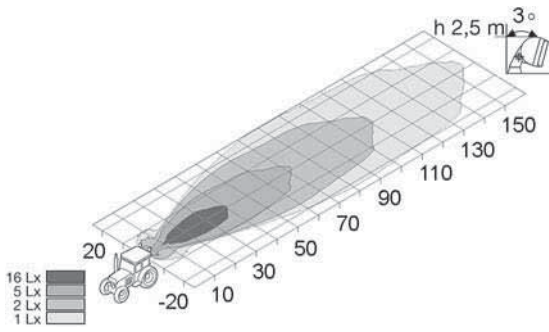

External-fitting work lights

AS 200 Xenon

Lens pattern for long-range illumination.
With gas discharge bulb. Light aperture: 123 x 123 mm.
 Recommended angle of inclination: 3° - 10°.
 Plastic reflector bonded with lens.
 Black plastic body with extending edge to protect lens.
 With red decorative ring. Handle recessed into body.
 Xenon electronic unit 42W integrated into body.
 Pivot base with bracket.
 Type of protection: IP64 and IP67.

Part no.	Pk.	
1GA 996 142-061	1	Xenon work light with 12V ballast unit, 2-pole AMP plug connector and 3100 mm long connecting lead with relay and fuse
1GA 996 142-071	1	with 24V ballast unit, 2-pole AMP plug connector and 3100 mm long connecting lead with relay and fuse
1GA 996 142-081	1	with 12V ballast unit, 2-pole AMP plug connector, switch, integrated fuse and 2500 mm long connecting lead
1GA 996 142-091	1	with 24V ballast unit, 2-pole AMP plug connector, switch, integrated fuse and 2500 mm long connecting lead
1GA 996 142-131	1	with 24V ballast unit, 2-pole AMP plug connector and black decorative ring, without connecting lead
1GA 990 305-071	1	Spare parts/Accessories: Light unit (D1S) 7/2011-> Ballast unit, 12V 24V
5DV 010 286-001	1	D1S gas discharge bulb, 35W
5DV 010 286-011	1	D2S gas discharge bulb, 35W
8GS 009 028-111	1	Cap for AMP plug connector
8GS 007 949-261	1	3100 mm long connecting lead with relay and fuse for AMP plug connector, 24V (for -071)
9GH 993 984-001	20	Blade-type fuses, 15A (5 pcs.)
8KB 990 299-121	1	Socket for AMP plug connector
8JS 711 687-821	10	Blade receptacles, 6.3 mm
8JD 008 151-011	1	Bracket attachment foot
8KW 701 235-033	100	Mounting bracket for tubular mount on 15 mm - 28 mm dia. pipes
8HG 990 320-001	1	
8HG 990 263-111	1	

External-fitting work lights for upright mounting

AS 200 Xenon

Lens pattern for long-range illumination.

With gas discharge bulb. Light aperture: 123 x 123 mm.

Recommended angle of inclination: 3° - 10°.

Plastic reflector bonded with lens.

Black plastic body and red lens-retaining rim with extending edge to protect lens.

With red decorative ring. Handle recessed into body.

Xenon electronic unit 42W integrated into body.

Type of protection: IP64 and IP67.

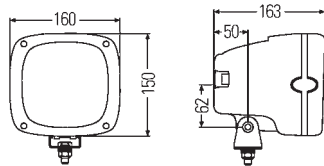
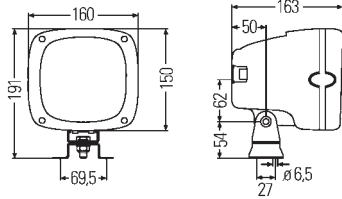
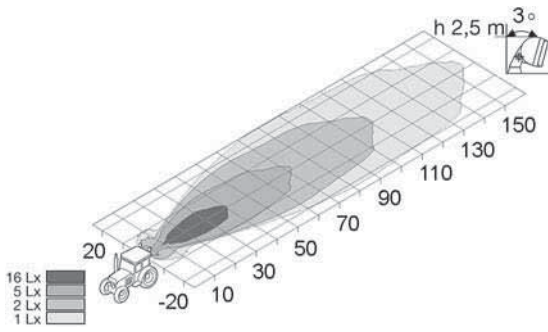

Part no.	Pk.	
1GA 996 142-151	1	Xenon work light with 24V ballast unit, PG-screwed connections and 3000 mm long connecting lead, without relay and fuse, sealed type, with pivot base with bracket
1GA 996 142-381	1	with 24V ballast unit, PG-screwed connections, 4500 mm long connecting lead, without relay and fuse, sealed type, with pivot base with bracket
1GA 996 142-251	1	with 230V ballast unit, PG-screwed connections and 10000 mm rubber tube with plug. Suitable for use with power generator 230V-VSG 40W, pivot base with M10 fixing screw
5DV 010 286-011	1	Spare parts: Ballast unit, 24V
8GS 009 028-111	1	D1S gas discharge bulb, 35W

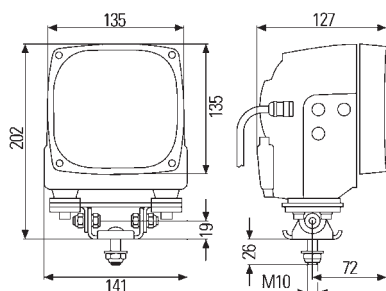
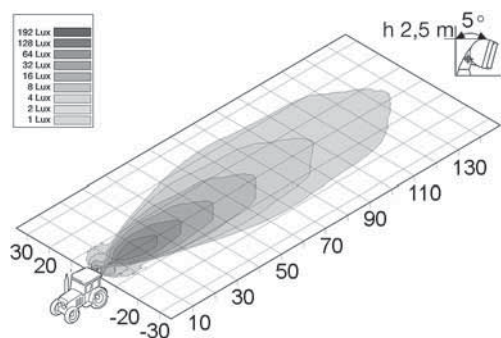
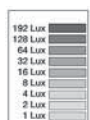

External-fitting work lights

AS 300 Xenon

Lens pattern for long-range illumination.

With gas discharge bulb. Light aperture: 123 x 123 mm.

Recommended angle of inclination: 3° - 10°.

Plastic reflector bonded with lens.

Black plastic body with extending edge to protect lens. With red decorative ring.

Handle recessed into body.

Xenon electronic unit 42W integrated into body.

Pivot base with bracket for four-point mounting with M10 fixing screws.

With vibration damping.

Type of protection: IP6K9K, IP67.

Part no.	Pk.	
1GA 996 242-541	1	Xenon work light, 2800 lm, with 24V ballast unit and 2-pole DEUTSCH plug connector
8GS 009 028-111	1	Spare parts/Accessories: D1S gas discharge bulb, 35W
8KB 990 299-231	1	3700 mm long connecting lead with relay and fuse for DEUTSCH plug connector,
8JA 990 295-127	10	24V
8JS 711 687-821	10	2-pole DEUTSCH plug
	1	Blade-type fuses, 15A (5 pcs.)

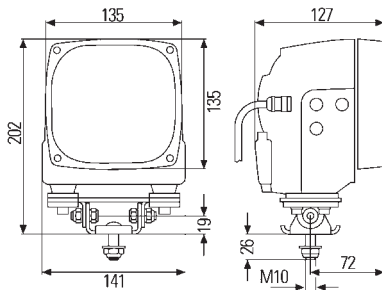
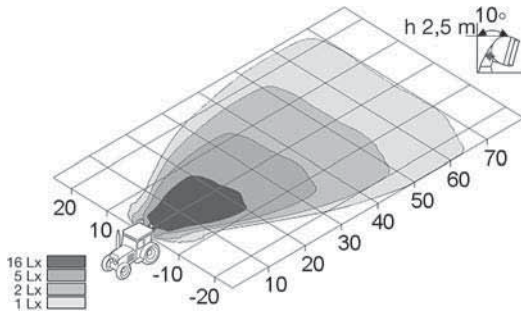

External-fitting work lights

AS 400 Xenon

Lens pattern for ground illumination.

With gas discharge bulb, 24V ballast unit and 200 mm connecting lead. Light aperture: 123 x 123 mm.

Recommended angle of inclination: 10° - 25°.

Plastic reflector bonded with lens.

Black body and red lens-retaining rim made of diecast aluminium.

Handle recessed into body.

Xenon electronic unit 42W integrated into body.

Pivot base made of stainless steel.

Type of protection: IP67.

Part no.	Pk.	
1GA 996 242-111	1	Xenon work light, 2800 lm, with vibration damping, pivot base with M10 fixing screw and 2-pole DEUTSCH plug connector
1GA 996 242-521	1	without vibration damping, pivot base with M12 fixing screw and 2-pole AMP plug connector
Spare parts/Accessories:		
1GA 990 305-001	1	Light unit
8GS 009 028-111	1	D1S gas discharge bulb, 35W
8KB 990 299-231	1	3700 mm connecting lead with relay and 15A fuse for DEUTSCH plug connector, 24V
8KB 990 299-121	1	3700 mm connecting lead with relay and fuse for AMP plug connector, 24V
8JA 990 295-127	10	2-pole DEUTSCH plug
8JS 711 687-821	1	Blade-type fuses, 15A (5 pcs.)

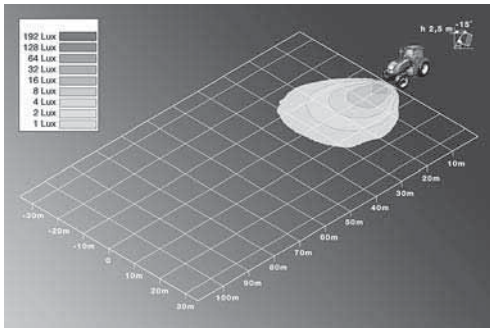

Built-in work lights

Ultra Beam Standard with FF reflector

Lens pattern for wide ground illumination.

Light aperture: 83 x 83 mm.

Recommended angle of inclination: 15° - 20°.

Double reflector made of diecast aluminium, glued to hardened glass lens.

Black plastic body with extending edge to protect lens.

With four 3.9 x 60 mm fixing screws.

Distance between screws: 66 x 95 mm.

Mounting area: 85 x 85 mm.

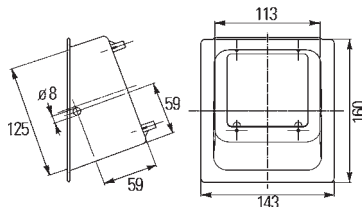
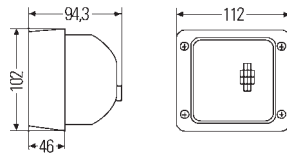

Part no.	Pk.	Description
1GA 007 506-121	1	Type of protection: IP5K4K FF H3 work light with grommet
1GA 007 506-111	1	Type of protection: IP6K4K and IPX9K FF H3 work light with 2-pole AMP plug connector and protection cap
1GA 007 506-061	1	FF H3 work light with 2-pole AMP plug connector and 12V55W bulb, without protection cap and fixing screws
1GA 007 506-431	1	FF H3 work light with 2-pole AMP plug connector and 24V70W bulb, without protection cap
1GA 998 525-001	1	Spare parts/Accessories: Light unit
8GH 002 090-271	1	H3 bulb, 12V35W
8GH 002 090-133	1	12V55W
8GH 002 090-251	1	24V70W
9GH 993 984-001	20	Cap for AMP plug connector
8KB 990 299-001	1	2000 mm long connecting lead for AMP plug connector with cap
8JD 008 151-011	10	Socket for AMP plug connector
8KW 701 235-033	100	Blade receptacles, 6.3 mm
9BG 990 353-001	1	(Supplied without work light) Mounting hollow, inclination 20°

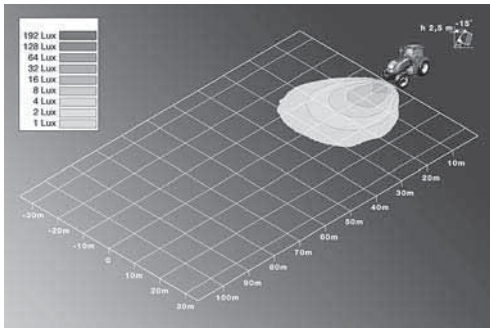

External-fitting work lights for upright or pendant mounting

Ultra Beam Standard with FF reflector

Lens pattern for wide ground illumination.

Light aperture: 83 x 83 mm.

Recommended angle of inclination: 15° - 20°.

Reflector made of diecast aluminium, glued to hardened glass lens.

Black plastic body with extending edge to protect lens.

Pivot base with M10 fixing screw.

Without vibration damping. Pivot range vertical 130°.

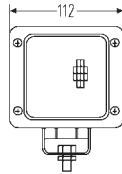
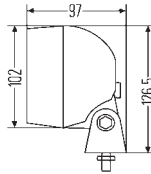

Part no.	Pk.	
1GA 007 506-081	1	Type of protection: IP5K4K FF H3 work light with grommet
1GA 007 506-001 1GA 007 506-007	1 30	Type of protection: IP6K4K and IPX9K FF H3 work light with 2-pole AMP plug connector and protection cap
1GA 007 506-002	10	FF H3 work light with 2-pole AMP plug connector and protection cap Self-service box
1GA 997 506-661	1	Type of protection: IP6K9K FF H3 work light with blue lens, 2-pole AMP plug connector and protection cap
1GA 007 506-391	1	FF H3 work light with 2-pole DEUTSCH plug connector and protection cap
1GA 997 506-371 1GA 997 506-377	1 18	FF H3 work light with magnet holder, vibration damping, PG-screw connection, 3500 mm long connecting lead with 2-pole plug and 12V35W bulb
1GA 998 525-001	1	Spare parts/Accessories: Light unit
8GH 002 090-271	1	H3 bulb,
8GH 002 090-133	1	12V35W
8GH 002 090-251	1	12V55W
9GH 993 984-001	20	24V70W
8HG 004 806-001	1	Cap for AMP plug connector
8JA 001 915-001	10	Magnet bracket
8JD 008 151-011	10	Plug, 2-pole
8KW 701 235-033	100	Socket for AMP plug connector
8HG 990 263-111	1	Blade receptacles, 6.3 mm
9XD 990 298-031	1	Mounting bracket for tubular mount on 15 mm - 28 mm dia. pipes
8KB 990 299-001	1	1 Angular bracket
8KB 990 299-011	1	2000 mm long connecting lead for AMP plug connector with cap
	1	2000 mm long connecting lead for DEUTSCH plug connector with cap

External-fitting work lights for pendant or side mounting

Ultra Beam Standard with FF reflector

Lens pattern for close-range illumination.
Light aperture: 83 x 83 mm. With 24V-bulb.

Reflector made of die-cast aluminium, glued to hardened glass lens.
Black fibre-glass reinforced plastic body
with extending edge to protect lens.
Pivot base with M10 fixing screw.

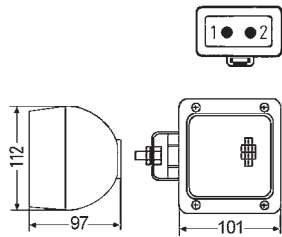
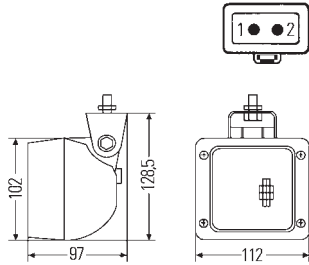

Part no.	Pk.	
1GA 007 506-547	30	FF H3 work light with 2-pole DEUTSCH plug connector and protection cap, for pendant mounting
1GA 997 506-217	70	for side mounting, left
1GA 997 506-227	70	for side mounting, right
Spare parts/Accessories:		
8GH 002 090-251	1	H3 bulb, 24V70W
8KW 701 235-033	100	Blade receptacles, 6.3 mm
8HG 990 263-111	1	Mounting bracket for tubular mount on 15 mm - 28 mm dia. pipes
9XD 990 298-031	1	Angular bracket
8KB 990 299-011	1	2000 mm long connecting lead for DEUTSCH plug connector with cap

External-fitting work lights for upright or pendant mounting

Lens pattern for long-range illumination.
Light aperture: 83 x 83 mm.

Recommended angle of inclination: 15° - 20°.
Reflector made of diecast aluminium,
glued to hardened glass lens.
Black plastic body with extending edge to protect lens.
Pivot base with M10 fixing screw.
Without vibration damping. Pivot range vertical 130°.

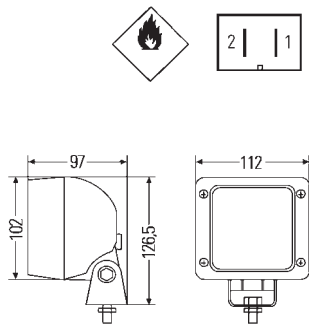
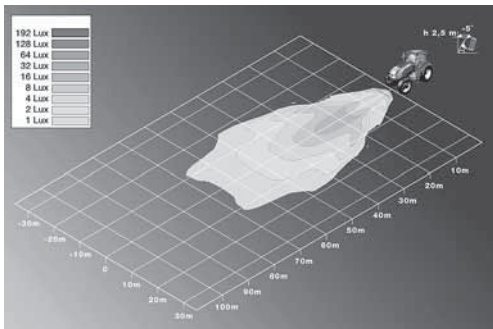

Part no.	Pk.	
1GA 997 506-021	1	Type of protection: IP6K4K and IPX9K FF H3 work light with 2-pole AMP plug connector and protection cap
Spare parts/Accessories:		
8GH 002 090-271	1	H3 bulb, 12V35W
8GH 002 090-133	1	12V55W
8GH 002 090-251	1	24V70W
8JD 008 151-011	10	Socket for AMP plug connector
8KW 701 235-033	100	Blade receptacles, 6.3 mm
8HG 990 263-111	1	Mounting bracket for tubular mount on 15 mm - 28 mm dia. pipes
9XD 990 298-031	1	Angular bracket
8KB 990 299-001	1	2000 mm long connecting lead for AMP plug connector with cap

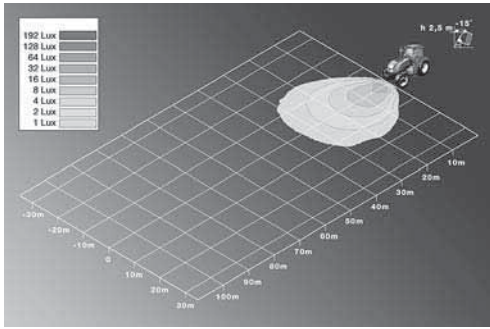

External-fitting work lights for upright or pendant mounting

Ultra Beam Heavy Duty with FF reflector

Lens pattern for wide ground illumination.
Light aperture: 83 x 83 mm.

Recommended angle of inclination: 15° - 20°.
Reflector made of diecast aluminium, glued to hardened glass lens.
Black plastic body with extending edge to protect lens.
Vibration damped pivot base with bracket for four-point mounting.
Pivot range vertical 130°.

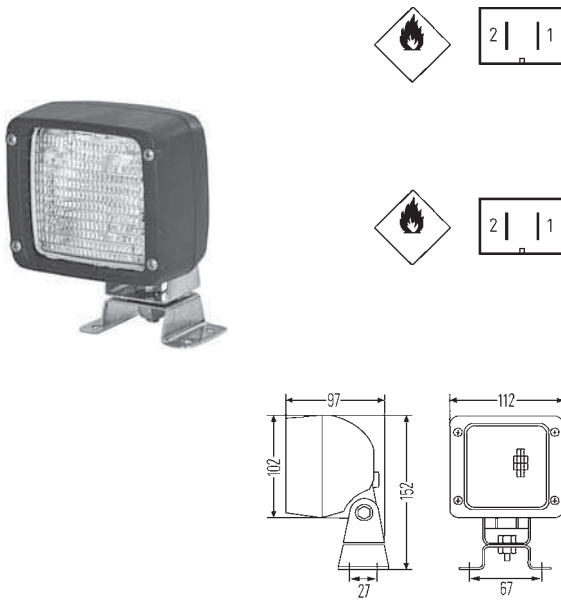

Part no.	Pk.	
1GA 007 506-011	1	Type of protection: IP6K4K and IPX9K FF H3 work light with 2-pole AMP plug connector and rubber cap
1GA 007 506-012	10	FF H3 work light with 2-pole AMP plug connector and rubber cap, self-service box
1GA 997 506-601	1	FF H3 work light with lens pattern-free, 2-pole AMP plug connector and rubber cap
1GA 007 506-091	1	Type of protection: IP5K4K FF H3 work light with grommet
1GA 998 525-001	1	Spare parts/Accessories: Light unit (except -601)
8GH 002 090-271	1	H3 bulb, 12V35W
8GH 002 090-133	1	12V55W
8GH 002 090-251	1	24V70W
9GH 993 984-001	20	Cap for AMP plug connector
8JD 008 151-011	10	Socket for AMP plug connector
8KW 701 235-033	100	Blade receptacles, 6.3 mm
8HG 990 263-111	1	Mounting bracket for tubular mount on 15 mm - 28 mm dia. pipes
8KB 990 299-001	1	2000 mm long connecting lead for AMP plug connector with cap

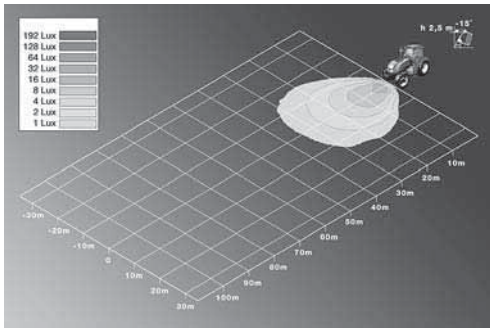

External-fitting work lights for upright or pendant mounting

Ultra Beam Heavy Duty with FF reflector

Lens pattern for wide ground illumination.

Light aperture: 83 x 83 mm.

Recommended angle of inclination: 15° - 20°.

Reflector made of diecast aluminium, glued to hardened glass lens.

Black plastic body with extending edge to protect lens.

Pivot base with vibration damping and M10 fixing screw.

Pivot range vertical 130°.

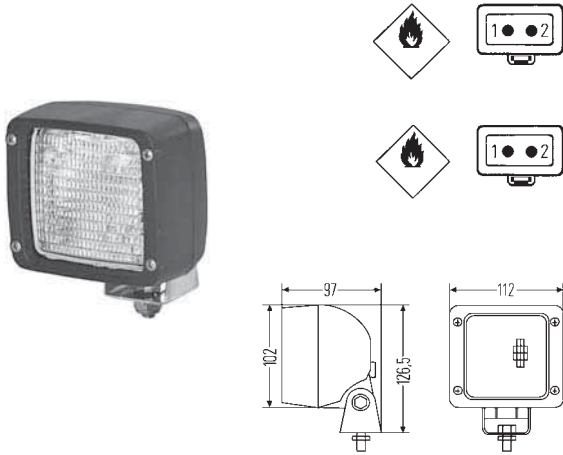

Part no.	Pk.	
1GA 007 506-651	1	FF H3 work light with 12V55W bulb and 2-pole DEUTSCH plug connector
1GA 007 506-491	1	FF H3 work light without bulb, with 2-pole DEUTSCH plug connector
1GA 007 506-451	1	FF H3 work light without bulb, with PG-lead retention
1GA 998 525-001	1	Spare parts/Accessories: Light unit
8GH 002 090-271	1	H3 bulb,
8GH 002 090-133	1	12V35W
8GH 002 090-251	1	12V55W
8KW 701 235-033	100	24V70W
8HG 990 263-111	1	Blade receptacles, 6.3 mm
9XD 990 298-031	1	Mounting bracket for tubular mount on 15 mm - 28 mm dia. pipes
8KB 990 299-011	1	Angular bracket 2000 mm long connecting lead for DEUTSCH plug connector with cap

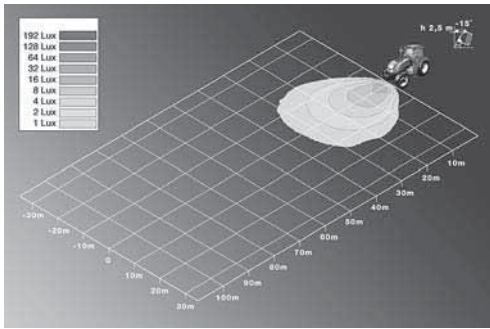

External-fitting work lights for upright or pendant mounting

Ultra Beam Heavy Duty with FF reflector

Lens pattern for wide ground illumination.
Light aperture: 83 x 83 mm.

Recommended angle of inclination: 15° - 20°.
 Reflector made of diecast aluminium, glued to hardened glass lens.
 Black plastic body with extending edge to protect lens. With handle.
 Pivot base with vibration damping and bracket for four-point mounting.
 Pivot range vertical 130°.

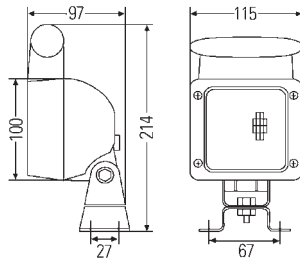
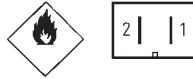

Part no.	Pk.	
1GA 007 506-021	1	Type of protection: IP6K4K and IPX9K FF H3 work light with 2-pole AMP plug connector and protection cap
1GA 997 506-631	1	FF H3 work light with lens pattern-free, switch, 2-pole AMP plug connector and protection cap
1GA 007 506-101	1	Type of protection: IP5K4K FF H3 work light with grommet
1GA 998 525-001	1	Spare parts/Accessories: Light unit
8GH 002 090-271	1	H3 bulb, 12V35W
8GH 002 090-133	1	12V55W
8GH 002 090-251	1	24V70W
9GH 993 984-001	20	Cap for AMP plug connector
9XD 990 298-001	5	Bracket for four-point fixing
8JD 008 151-011	10	Socket for AMP plug connector
8KW 701 235-033	100	Blade receptacles, 6.3 mm
8HG 990 263-111	1	Mounting bracket for tubular mount on 15 mm - 28 mm dia. pipes
8KB 990 299-001	1	2000 mm long connecting lead for AMP plug connector with cap

External-fitting work lights for upright mounting

Lens pattern for wide close-range illumination.
Light aperture: 83 x 83 mm.

Recommended angle of inclination: 15° - 20°.
 Reflector made of diecast aluminium, glued to hardened glass lens.
 Black plastic body and lens-retaining rim with extending edge to protect lens.
 With spigot mount 24 mm dia. with integrated electrical contacts (DIN 72591).
 Type of protection: IP5K4K and IPX9K.

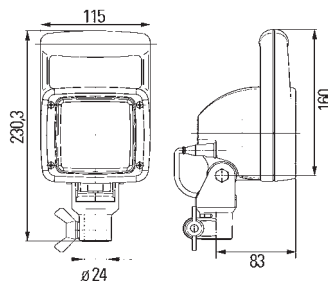
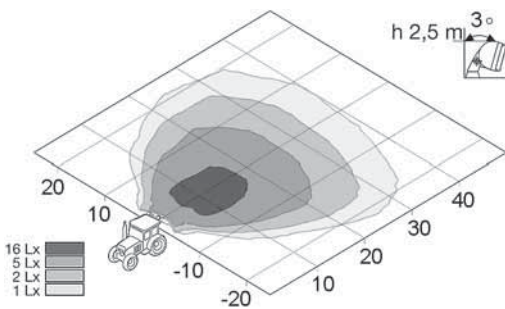

Part no.	Pk.	
1GA 007 506-681	1	FF H3 work light with handle and 24V bulb
1GA 998 525-001	1	Spare parts/Accessories: Light unit
8GH 002 090-271	1	H3 bulb, 12V35W
8GH 002 090-133	1	12V55W
8GH 002 090-251	1	24V70W
8HG 990 320-001	1	Bracket attachment foot
8HG 006 294-021	1	Push-on pipe, 24 mm dia.

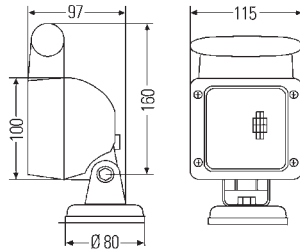
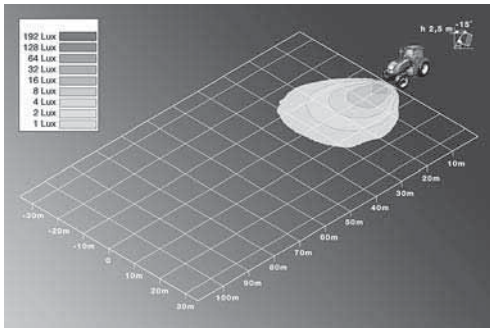

External-fitting work lights

Ultra Beam Heavy Duty with FF reflector

Lens pattern for wide ground illumination.

With 24V70W bulb. Light aperture: 83 x 83 mm.

Recommended angle of inclination: 15° - 20°.

Reflector made of diecast aluminium, glued to hardened glass lens.

Black plastic body with extending edge to protect lens. With handle.

With magnet base, lead retention, and spirally coiled lead, stretched length of lead 3500 mm.

Pivot range vertical 130°.

Part no.	Pk.	
1GA 997 506-157	1	FF H3 work light with 3-pole plug
1GA 997 506-557	1	with 2-pole plug
Spare parts/Accessories:		
1GA 998 525-001	1	Light unit
8GH 002 090-271	1	H3 bulb,
8GH 002 090-133	1	12V35W
8GH 002 090-251	1	12V55W
8JA 002 263-031	1	24V70W
8JA 001 915-001	1	Plug, 3-pole
8JB 001 933-031	10	Delphi plug-set, 2-pole (Contents: 20 pieces)
	1	Socket, 3-pole for -157

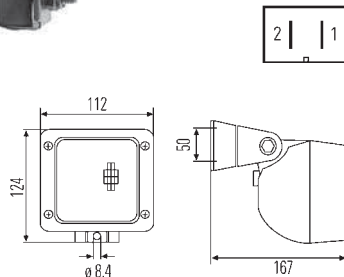
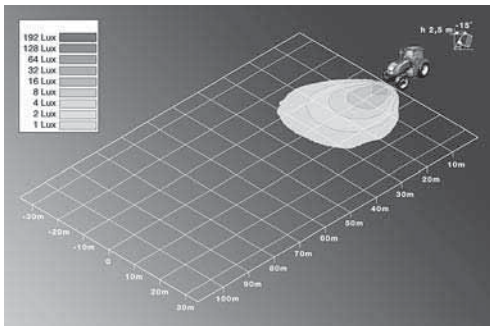

Ultra Beam Standard with FF reflector

Lens pattern for wide ground illumination.

Light aperture: 83 x 83 mm.

Recommended angle of inclination: 15° - 20°.

Reflector made of diecast aluminium, glued to hardened glass lens.

Black plastic body with extending edge to protect lens.

With side rotary pivot base.

With M10 fixing screw for mounting on vertical surfaces.

Pivot range: horizontal 130°, inclination range: vertical 90°.

Part no.	Pk.	
1GA 996 083-011	1	Type of protection: IP5K4K FF H3 work light with grommet
1GA 996 083-001	1	Type of protection: IP6K4K and IPX9K FF H3 work light with 2-pole AMP plug connector and protection cap
Spare parts/Accessories:		
1GA 998 525-001	1	Light unit
8GH 002 090-271	1	H3 bulb,
8GH 002 090-133	1	12V35W
8GH 002 090-251	1	12V55W
9GH 993 984-001	20	24V70W
		Cap for AMP plug connector
8HG 990 263-001	1	Mounting bracket for tubular mount on 15 - 28 mm dia. pipes
9XD 990 298-031	1	Angular bracket
9XD 990 298-001	5	Bracket for four-point mounting
8KB 990 299-001	1	2000 mm long connecting lead for AMP plug connector with cap
8JD 008 151-011	10	Socket for AMP plug connector
8KW 701 235-033	100	Blade receptacles, 6.3 mm

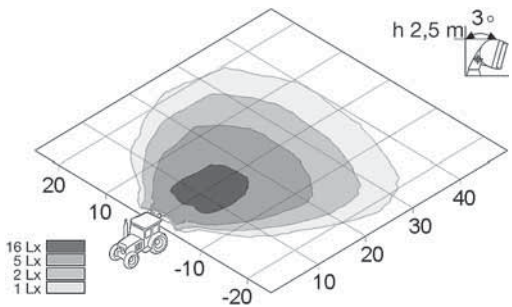

External-fitting work lights for upright mounting

Ultra Beam H9 with FF reflector

Lens pattern for wide close-range illumination.

With 12V bulb. Light aperture: 83 x 83 mm.

Recommended angle of inclination: 3° - 10°.

Reflector made of diecast aluminium, glued to hardened glass lens.

Black plastic body with extending edge to protect lens.

Pivot base with bracket for four-point mounting, without vibration damping.

Type of protection: IP5K4K and IPX9K.

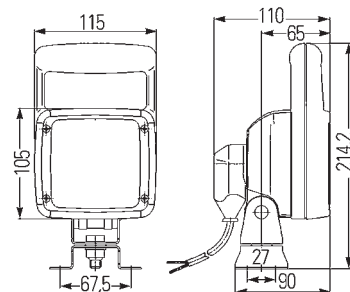
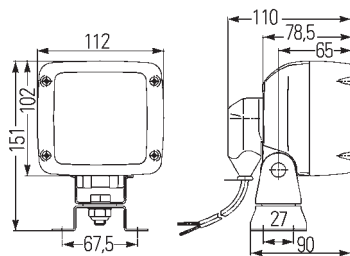
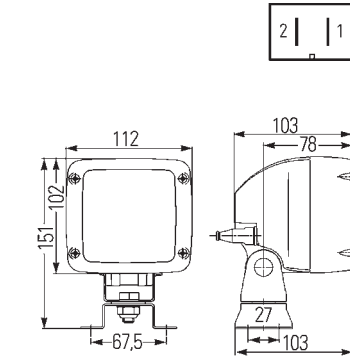

Part no.	Pk.	Description
1GA 996 150-081	1	FF H9 work light with 2-pole AMP plug connector and protection cap
8GH 008 357-001	1	Spare parts/Accessories: H9 bulb, 12V65W
9GH 993 984-001	20	Cap for AMP plug connector
8KB 990 299-001	1	2000 mm long connecting lead for AMP plug connector with cap
1GA 996 150-021	1	with 2000 mm long connecting lead and protection cap to cover the bulb. 12V bulb accessible from the outside
8GH 008 357-001	1	Spare parts/Accessories: H9 bulb, 12V65W
8JD 158 175-807	1	H9 socket set (20 pcs.)
1GA 996 150-071	1	with handle, with 2000 mm long connecting lead and protection cap to cover the bulb. 12V bulb accessible from the outside
8GH 008 357-001	1	Spare parts/Accessories: H9 bulb, 12V65W
8HG 990 263-111	1	Mounting bracket for tubular mount on 15 mm - 28 mm dia. pipes

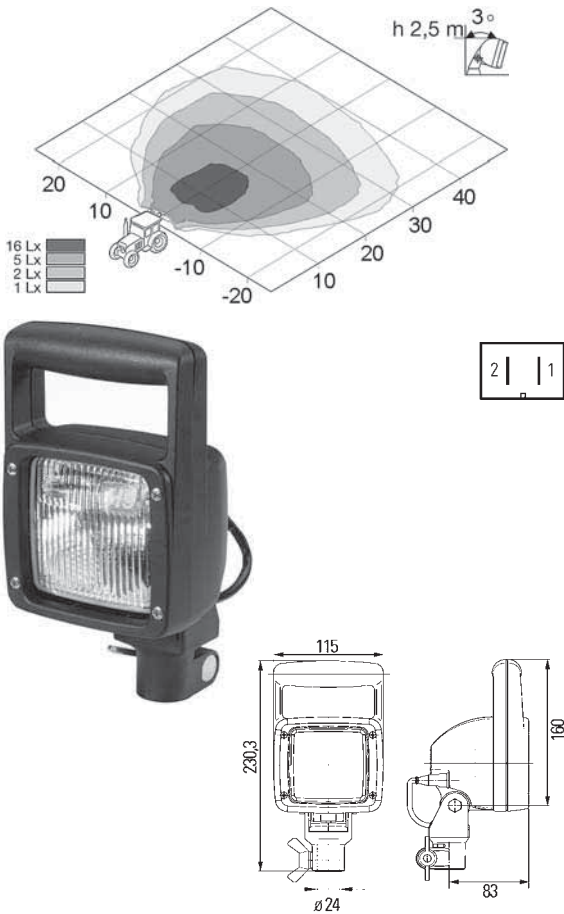

External-fitting work lights for upright mounting

Ultra Beam H9 with FF reflector

Lens pattern for wide close-range illumination.

Light aperture: 83 x 83 mm.

Recommended angle of inclination: 3° - 10°.

Reflector made of diecast aluminium, glued to hardened glass lens.

Black plastic body and lens-retaining rim with extending edge to protect lens.

With spigot mount 24 mm dia. with integrated electrical contacts (DIN 72591).

Type of protection: IP5K4K and IPX9K.

Part no.	Pk.	
1GA 996 150-151	1	FF H9 work light with 2-pole AMP plug connector and protection cap, with handle and 12V bulb
8GH 008 357-001	1	Spare parts/Accessories: H9 bulb, 12V65W
8HG 990 320-001	1	Bracket attachment foot
8HG 990 320-011	1	Bracket attachment foot with 200 mm long lead and
8HG 006 294-021	1	2-pole DEUTSCH plug connector
	1	Push-on pipe, 24 mm dia.

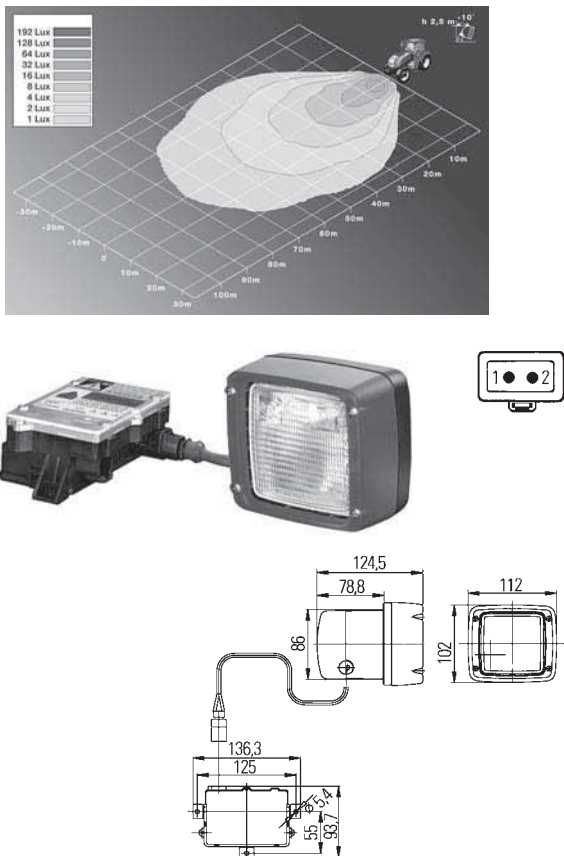

Built-in work lights

Ultra Beam Xenon

Lens pattern for wide, intense and long-range illumination.

With 2-pole DEUTSCH plug connector and gas discharge bulb.

Light aperture: 83 x 83 mm.

Reflector made of diecast aluminium, glued to hardened glass lens.

Black body and red lens-retaining rim made of plastic.

Work light permanently connected by 3000 mm long lead with ballast unit 42W.

The lead can be disconnected from the ballast unit by means

of a plug-connection.

Without connecting lead.

Type of protection: IP5K4K.

Part no.	Pk.	
1GA 998 534-541	1	Xenon work light with 24V ballast unit
8GS 009 028-111	1	Spare parts/Accessories: D1S gas discharge bulb, 35W
5DV 008 856-001	1	Ballast unit,
5DV 008 856-007	24	24V
8KB 990 299-241	1	Connector lead between work light and ballast unit, 1000 mm
8KB 990 299-251	1	3000 mm
8KB 990 299-221	1	3700 mm long connecting lead with relay and fuse for DEUTSCH plug connector,
8KB 990 299-231	1	12V
	1	24V

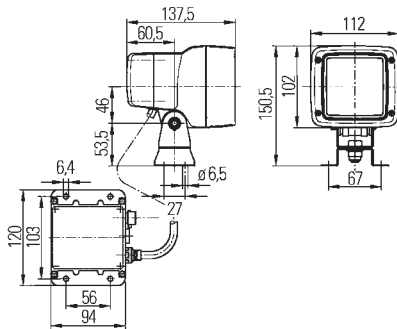
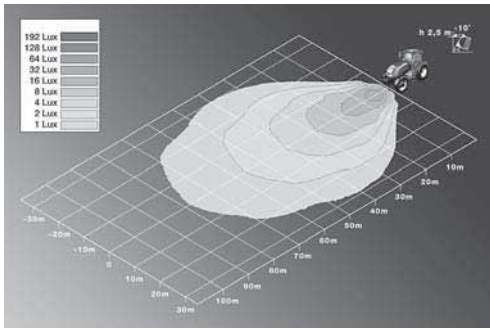

External-fitting work lights for upright or pendant mounting

Ultra Beam Xenon

Lens pattern for extremely wide, intense and long-range illumination. With gas discharge bulb. Light aperture: 83 x 83 mm.

Reflector made of diecast aluminium, glued to hardened glass lens.

Black plastic body and red lens-retaining rim.

Lens-retaining rim with extending edge to protect lens.

Pivot base with vibration damping.

Pivot range vertical 105°. Type of protection: IP5K4K.

Part no.	Pk.	
1GA 998 534-001	1	Xenon work light with bracket for four-point mounting made of stainless steel and 3700 mm long connecting lead, relay and 15A fuse, with 12V ballast unit
1GA 998 534-011	1	with 24V ballast unit
Spare parts/Accessories:		
1GA 998 525-011	1	Light unit
8GS 007 949-261	1	D2S gas discharge bulb, 35W
5DV 990 264-001	1	Ballast unit, 12V
5DV 990 264-011	1	24V
8KB 149 147-001	1	3000 mm long connecting lead from ballast unit to battery, with relay and fuse, 12V

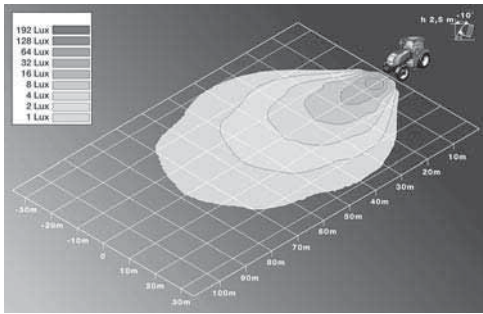

External-fitting work lights for upright mounting

Ultra Beam Xenon

Lens pattern for wide, intense and long-range illumination. With 2-pole DEUTSCH plug connector and gas discharge bulb. Light aperture: 83 x 83 mm.

Reflector made of diecast aluminium, glued to hardened glass lens. Black body and red lens-retaining rim made of plastic. Pivot base with vibration damping and bracket for four-point mounting made of stainless steel. Pivot range vertical 105°. Work light permanently connected by lead with ballast unit 42W. The lead can be disconnected from the ballast unit by means of a plug-connection. Without connecting lead. Type of protection: IP5K4K.

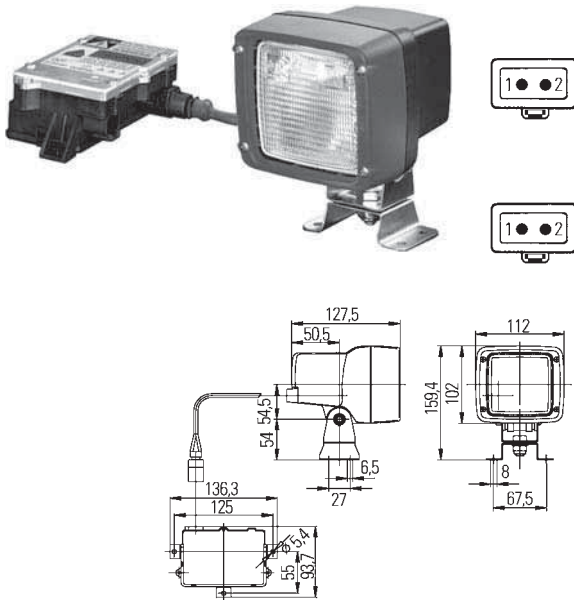

Part no.	Pk.	
1GA 998 534-221	1	Xenon work light with 3000 mm long connector lead and 12V ballast unit
1GA 998 534-231	1	and 24V ballast unit
1GA 998 534-271	1	Xenon work light with 500 mm long connector lead and 24V ballast unit
Spare parts/Accessories:		
8GS 009 028-111	1	D1S gas discharge bulb, 35W
		Ballast unit,
5DV 008 855-001	1	12V
5DV 008 855-007	24	
5DV 008 856-001	1	24V
5DV 008 856-007	24	
8KB 990 299-241	1	Connection lead between work light and ballast unit, 1000 mm
8KB 990 299-251	1	3000 mm
		3700 mm long connecting lead with relay and fuse for DEUTSCH plug connector,
8KB 990 299-221	1	12V
8KB 990 299-231	1	24V

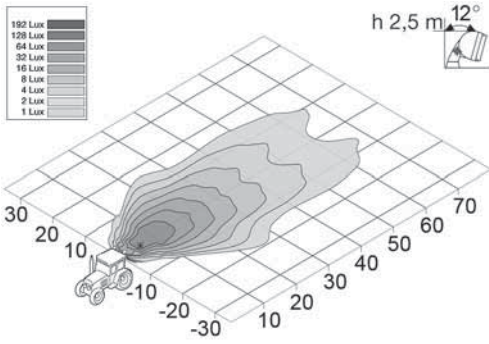

External-fitting work lights

Ultra Beam Xenon

Lens pattern for close-range illumination.

With gas discharge bulb. Light aperture: 83 x 83 mm.

Recommended angle of inclination: 3° - 10°.

Reflector made of diecast aluminium, glued to hardened glass lens.

Black plastic body and red lens-retaining rim with extending edge to protect lens.

Rear of body made of black diecast aluminium.

Work light permanently connected to ballast unit by a 500 mm long lead.

Vibration-damped pivot base with bracket for four-point mounting.

Type of protection: IP5K9K. System capacity: 50W.

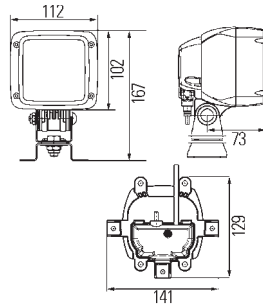

Part no.	Pk.	
1GA 998 534-671	1	Xenon work light with 100 mm long lead and 2-pole AMP plug connector, for upright mounting, with 12V ballast unit
8GS 009 028-111	1	Spare parts: D1S gas discharge bulb, 35W

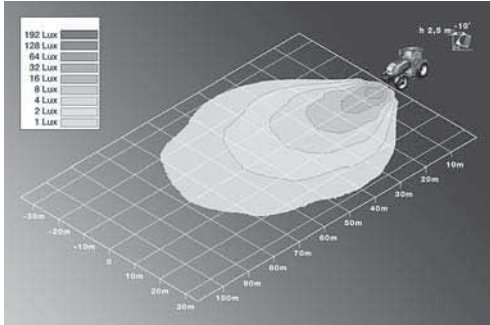

External-fitting work lights

Ultra Beam Xenon-Powerpack

Lens pattern for close-range illumination.

With gas discharge bulb, 500 mm long lead and 2-pole AMP plug

Light aperture: 83 x 83 mm.

Recommended angle of inclination: 3° - 10°.
 Reflector made of diecast aluminium, glued to hardened glass lens.
 Black plastic body and red lens-retaining rim made of plastic, with extending edge to protect lens.
 Rear of body made of black diecast aluminium.
 Xenon electronic unit integrated into body.
 Vibration-damped pivot base with bracket for four-point mounting.
 Additionally enclosed, displaceable bracket for single-point attachment.
 Type of protection: IP5K4K. System capacity: 42W.

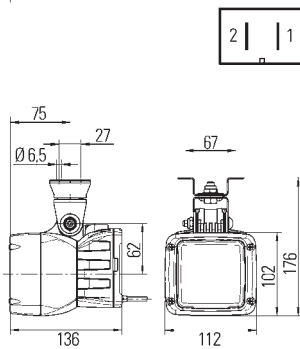
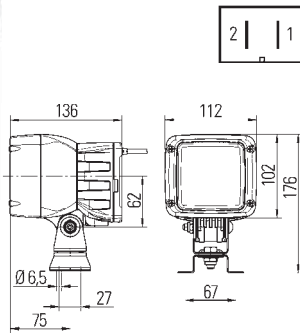

Part no.	Pk.	
1GA 998 534-431	1	Xenon work light for upright mounting, with 12V ballast unit
1GA 998 534-451	1	with 24V ballast unit
1GA 998 534-441	1	Xenon work light for pendant mounting, with 12V ballast unit
1GA 998 534-461	1	with 24V ballast unit
8GS 009 028-111	1	Spare parts: D1S gas discharge bulb, 35W

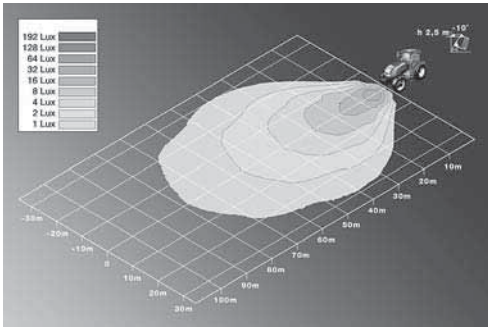

External-fitting work lights for upright mounting

Ultra Beam Xenon-Powerpack

With gas discharge bulb, 300 mm long lead and 2-pole DEUTSCH plug connector. Light aperture: 83 x 83 mm. Recommended angle of inclination: 3° - 10°. Reflector made of diecast aluminium, glued to hardened glass lens. Black plastic body with red extending edge to protect lens. Rear of body made of black die-cast aluminium. Xenon electronic unit 42W integrated into body. Vibration-damped pivot base with bracket for four-point mounting. Additionally enclosed, displaceable bracket for single-point attachment. Type of protection: IP5K4K.

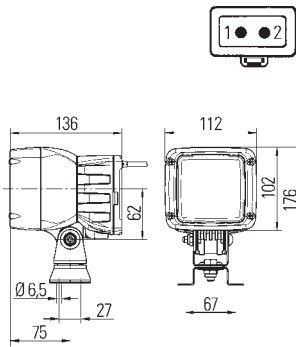

Part no.	Pk.	
1GA 998 534-491	1	Xenon work light with 24V ballast unit, with red lens-retaining rim and lens pattern for close-range illumination
1GA 998 534-601	1	with black lens-retaining rim and lens pattern for close-range illumination
8GS 009 028-111	1	Spare parts: D1S gas discharge bulb, 35W

External-fitting work lights for upright or pendant mounting

Ultra Beam LED

With 9 Power LEDs 30W. Light aperture: 105 x 95 mm.
2-pole DEUTSCH plug connector integrated.
9-part reflector made of plastic, glued to pattern-free lens.
Black finish aluminium body with cooling ribs.
Voltage range: 12V - 24V.
Type of protection: IP6k7 and IP6K9K.

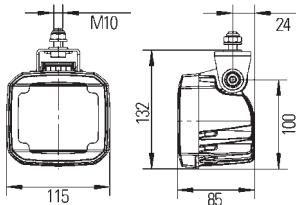
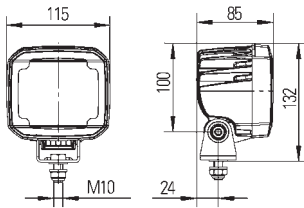

Part no.	Pk.	
		Lens pattern for close-range illumination.
1GA 995 506-001	1	LED work light with clear plastic lens, 2000 lm. Pivot base with M10 fixing screw for upright mounting
1GA 995 506-002	1	LED work light with plastic lens, clear, 2000 lm. Pivot base with M10 fixing screw for upright mounting, carded
1GA 995 506-061	1	LED work light with plastic lens, clear, 2200 lm and supply unit 230V for stationary power connection. Pivot base with M10 fixing screw for upright mounting
1GA 995 506-011	1	LED work light with clear plastic lens, 2000 lm. Pivot base with M10 fixing screw for pendant mounting
1GA 995 506-021	1	LED work light with clear plastic lens, 2000 lm. Pivot base with U-bracket for four-point mounting, for upright mounting
1GA 995 506-041	1	LED work light with clear plastic lens, 2000 lm, pivot base with bracket for four-point mounting, for pendant mounting
8KB 990 299-011	1	Accessories: 2000 mm long connecting lead for DEUTSCH plug connector with cap

External-fitting work lights for upright or pendant mounting

Ultra Beam LED

With 9 Power LEDs 30W. Light aperture: 105 x 95 mm.
2-pole DEUTSCH plug connector integrated.
9-part reflector made of plastic, glued to pattern-free lens.
Black finish aluminium body with cooling ribs.
Voltage range: 12V - 24V.
Type of protection: IP6k7 and IP6K9K.

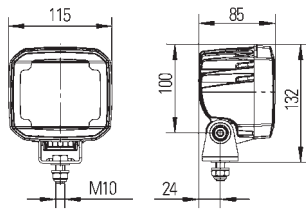

Part no.	Pk.	
		Lens pattern for long-range illumination.
1GA 995 506-031	1	LED work light with clear plastic lens, 2000 lm. Pivot base with M10 fixing screw for upright or pendant mounting
1GA 995 506-071	1	LED work light with plastic lens, clear, 2200 lm and supply unit 230V for stationary power connection. Pivot base with M10 fixing screw for upright mounting
		Lens pattern for extra-wide illumination.
1GA 995 506-051	1	LED work light with clear plastic lens, 2000 lm. Pivot base with M10 fixing screw for upright or pendant mounting
		Lens pattern for spot illumination.
1GA 995 506-101	1	LED work light with clear plastic lens, 2000 lm. Pivot base with M10 fixing screw for upright or pendant mounting
		Accessories:
8KB 990 299-011	1	2000 mm long connecting lead for DEUTSCH plug connector with cap

External-fitting work lights for upright or pendant mounting

Power Xen

With gas discharge bulb. Light aperture: 80 x 80 mm.

Reflector made of diecast aluminium, glued to hardened glass lens.

Black plastic body with red plastic intermediate ring.

Xenon electronic unit 42W integrated into body.

Pivot base with M10 fixing screw.

Type of protection: IP5K4K and IPX9K. System capacity: 42W.

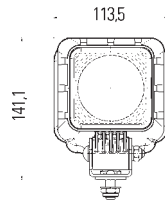
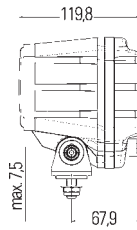

Part no.	Pk.	
1GA 996 196-001	1	Xenon work light with lens pattern for close-range illumination, integrated 2-pole DEUTSCH plug connector and 12V ballast unit
1GA 996 196-011	1	integrated 2-pole DEUTSCH plug connector and 24V ballast unit
1GA 996 196-021	1	500 mm long lead and 12V ballast unit
1GA 996 196-031	1	500 mm long lead and 24V ballast unit
1GA 996 196-041	1	Xenon work light with lens pattern for long-range illumination, integrated 2-pole DEUTSCH plug connector and 24V ballast unit
1GA 996 196-051	1	500 mm long lead and 24V ballast unit
8GS 009 028-111	1	Spare parts/Accessories: D1S gas discharge bulb, 35W
8KB 990 299-011	1	2000 mm long connecting lead for DEUTSCH plug connector with cap

External-fitting work lights for upright or pendant mounting

Q90 LED

With 4 Power LEDs and 500 mm long lead.

Light aperture: 90 x 84 mm.

4-part reflector made of plastic, glued to pattern-free lens.

Black plastic body with cooling ribs.

Pivot base with M10 fixing screw.

Voltage range: 12V - 24V, 25W.

Type of protection: IP6K7 and IP6K9K.

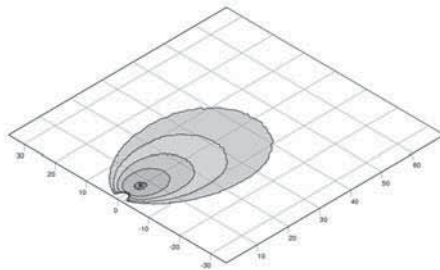
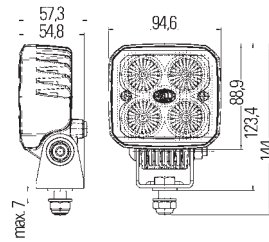

Max. 0 1 2 4 8 16

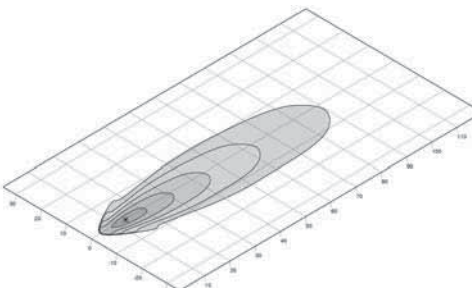

Max. 0 1 2 4 8 16

Part no.	Pk.	
1GA 996 283-001	1	LED work light with clear plastic lens, 1200 lm, with lens pattern for close-range illumination
1GA 996 283-002	1	with lens pattern for close-range illumination, carded
1GA 996 283-031	1	with 2-pole DEUTSCH plug connector and lens pattern for close-range illumination
1GA 996 283-011	1	with lens pattern for long-range illumination
1GA 996 283-041	1	with 2-pole DEUTSCH plug connector and lens pattern for long-range illumination

External-fitting work lights for upright or pendant mounting

Power Beam 1000

Lens pattern for close-range illumination.

With 6 Power LEDs. Light aperture: 100 x 80 mm.

6-part reflector made of plastic, glued to pattern-free lens.

Black finish aluminium body with cooling ribs.

Voltage range: 12V - 24V, 18W.

Type of protection: IP6K7 and IP6K9K.

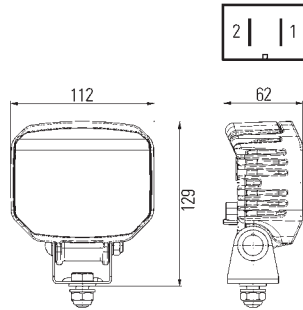

Part no.	Pk.	
1GA 996 188-031	1	LED work light with 2-pole AMP plug connector and pivot base made of stainless steel with M10 fixing screw, rear of housing made of blue plastic, without vibration dumping, with plastic lens, 850 lm
1GA 996 188-032	1	rear of housing made of blue plastic, without vibration dumping, with plastic lens, 850 lm Self-service box
1GA 996 188-001	1	LED work light with 2-pole DEUTSCH plug connector and pivot base made of stainless steel with M10 fixing screw, rear of body made of blue plastic, without vibration dumping, with glass lens, 850 lm
1GA 996 188-021	1	rear of body made of black plastic, without vibration dumping, with plastic lens, 850 lm
1GA 996 188-011	1	LED work light with 2-pole DEUTSCH plug connector and Heavy Duty bracket with M10 fixing screw, rear of housing made of blue plastic, with vibration dumping and glass lens, 850 lm
8KB 990 299-001	1	Accessories: 2000 mm long connection lead, for AMP connector with cap
8KB 990 299-011	1	for DEUTSCH plug connector with cap
9XD 990 298-031	1	Angular bracket (except -011)

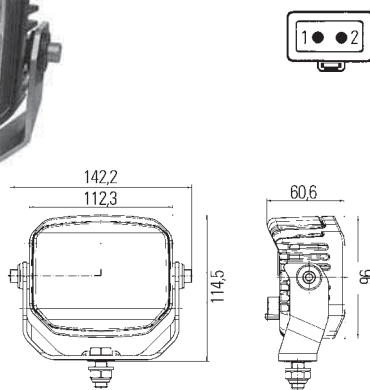

External-fitting work lights for upright or pendant mounting

Power Beam 1500

With 6 Power LEDs. Light aperture: 100 x 80 mm.
 6-part reflector made of plastic, glued to pattern-free lens.
 Black finish aluminium body with cooling ribs.
 Rear of body made of grey plastic.
 2-pole DEUTSCH plug connector integrated.
 Voltage range: 12V - 24V, 22W.
 Type of protection: IPX7 and IP6K9K.

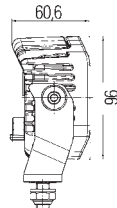
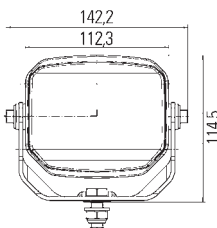
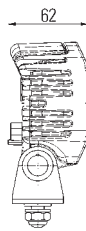
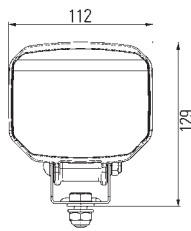

Part no.	Pk.	
		With pivot base made of stainless steel with M10 fixing screw, without vibration dumping.
1GA 996 288-001	1	LED work light with plastic lens, clear, 1300 lm and lens pattern for long-range illumination
1GA 996 288-041	1	LED work light with orange plastic lens, 850 lm and lens pattern for long-range illumination
1GA 996 288-011	1	LED work light with plastic lens, clear, 1300 lm and lens pattern for close-range illumination
1GA 996 288-012	1	LED work light with plastic lens, clear, 1300 lm and lens pattern for close-range illumination Self-service box
		With reinforced pivot base made of stainless steel with M10 fixing screw, without vibration damping.
1GA 996 288-171	1	LED work light with plastic lens, clear, 1300 lm and lens pattern for close-range illumination
		With Heavy Duty bracket with M10 fixing screw, with vibration dumping.
1GA 996 288-021	1	LED work light with plastic lens, clear, 1300 lm and lens pattern for long-range illumination
1GA 996 288-031	1	LED work light with plastic lens, clear, 1300 lm and lens pattern for close-range illumination
		With reinforced Heavy Duty bracket, M10 fixing screw and vibration dumping.
1GA 996 288-147	18	LED work light with clear plastic lens, 1300 lm and lens pattern for close-range illumination
		Accessories:
8KB 990 299-011	1	2000 mm long connecting lead for DEUTSCH plug connector with cap
9XD 990 298-031	1	Angular bracket (except -021/-031/-147)

External fitting work lights for upright mounting

Power Beam 1800

**With 6 Power LEDs 32W. Light aperture: 100 x 80 mm.
With dimming function.**

6-part reflector made of plastic, glued to pattern-free lens.
Black finish aluminium body with cooling ribs.

Rear of body made of black plastic.

2-pole DEUTSCH plug connector integrated.

With polarity reversal protection.

Type of protection: IPX7 and IP6K9K.

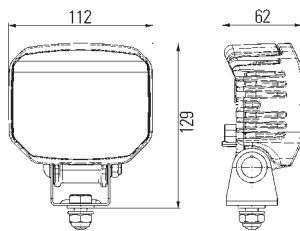

Part no.	Pk.	
1GA 996 388-001	1	With pivot base made of stainless steel with M10 fixing screw, without vibration dumping. LED work light, 12V, with plastic lens, clear, 1850 lm and lens pattern for close-range illumination
1GA 996 388-011	1	LED work light, 24V, with plastic lens, clear, 1850 lm and lens pattern for close-range illumination
1GA 996 388-021	1	LED work light, 12V, with plastic lens, clear, 1850 lm and lens pattern for long-range illumination
1GA 996 388-031	1	LED work light, 24V, with plastic lens, clear, 1850 lm and lens pattern for long-range illumination
8KB 990 299-011	1	Accessories: 2000 mm long connecting lead for DEUTSCH plug connector with cap
9XD 990 298-031	1	Angular bracket

External-fitting work lights

Power Beam 2000

With 16 Power LEDs. Light aperture: 83 x 83 mm.
 16-part reflector made of plastic, glued to pattern-free lens.
 Black finish aluminium body with cooling ribs.
 Rear of body made of blue plastic.
 Pivot base made of stainless steel with M10 fixing screw.
 Without vibration dumping.
 Voltage range: 12V - 24V, 43W. Type of protection: IP6K7 and IP6K9K.

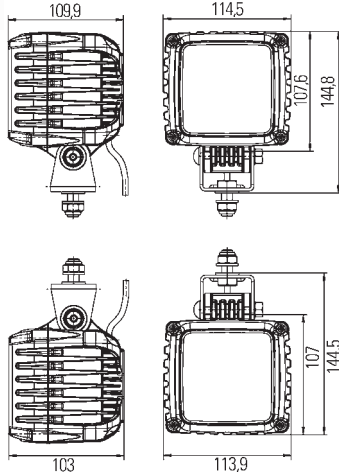

Part no.	Pk.	
1GA 996 189-001	1	Lens pattern for close-range illumination. With 2000 mm long lead with polarity reversal protection. LED work light with glass lens, 2000 lm, for upright mounting
1GA 996 189-031	1	LED work light with glass lens, 2000 lm, for pendant mounting
1GA 996 189-011	1	Lens pattern for close-range illumination. With 2-pole DEUTSCH plug connector. LED work light with glass lens, 2200 lm, for upright mounting
1GA 996 189-071	1	LED work light with plastic lens, 2200 lm, for pendant mounting
8KB 990 299-011	1	Accessories: 2000 mm long connecting lead for DEUTSCH plug connector with cap
1GA 996 189-051	1	Lens pattern for long-range illumination. With 2000 mm long lead with polarity reversal protection. LED work light with plastic lens, 2200 lm, for upright mounting
9XD 990 298-031	1	Accessories: Angular bracket

External-fitting work lights

Power Beam 3000

With 16 Power LEDs. Light aperture: 83 x 83 mm.

16-part reflector made of plastic, glued to pattern-free lens.

Black finish aluminium body with cooling ribs.

Without vibration damping.

Voltage range: 12V - 24V, 43W. Type of protection: IP6K7 and IP6K9K.

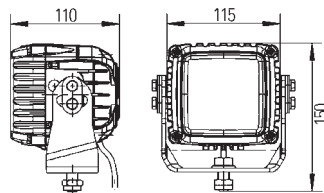
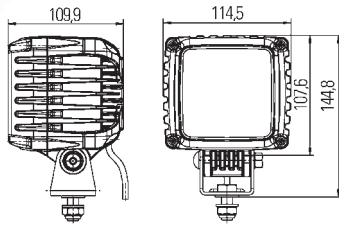

Part no.	Pk.	
1GA 996 192-127	1	<p>For upright mounting. With 2-pole DEUTSCH plug connector with polarity reversal protection. Pivot base with M10 fixing screw.</p> <p>LED work light with plastic lens, 3000 lm and lens pattern for close-range illumination, rear of body made of silver plastic</p>
9XD 990 298-031	1	<p>Accessories: Angular bracket</p>
1GA 996 192-157	1	<p>For upright mounting. With 2-pole DEUTSCH plug connector with polarity reversal protection. Pivot base with M12 fixing screw.</p> <p>LED work light with plastic lens, 3000 lm and lens pattern for close-range illumination, rear of body made of grey plastic</p>
8KB 990 299-011	1	<p>Accessories: 2000 mm long connecting lead for DEUTSCH plug connector with cap</p>
1GA 996 192-261	1	<p>For upright mounting. With 2000 mm long lead, 2-pole AMP plug connector and polarity reversal protection. Heavy Duty bracket with M12 fixing screw.</p> <p>LED work light with plastic lens, 3000 lm and lens pattern for long-range illumination, rear of body made of silver plastic</p>
8KB 990 299-001	1	<p>Accessories: 2000 mm long connecting lead for AMP plug connector with cap</p>

External-fitting work lights

Power Beam 3000

With 16 Power LEDs. Light aperture: 83 x 83 mm.

16-part reflector made of plastic, glued to lens.

Black finish aluminium body with cooling ribs.

Rear of body made of silver plastic.

Without vibration damping.

Voltage range: 12V - 24V, 43W. Type of protection: IP6K7 and IP6K9K.

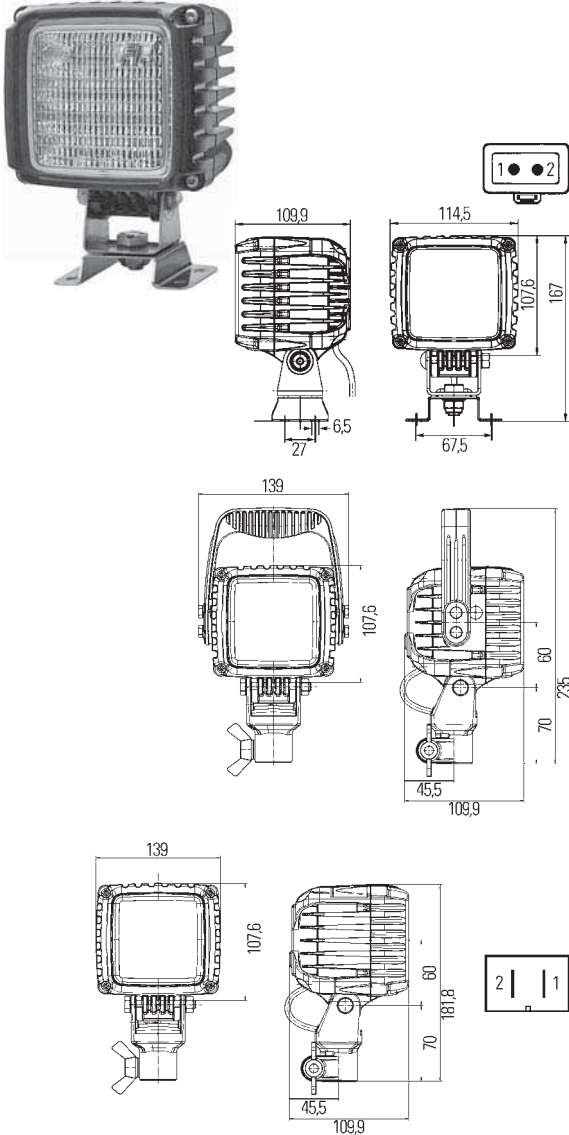

Part no.	Pk.	
1GA 996 192-081	1	<p>For upright mounting. With 2-pole DEUTSCH plug connector and polarity reversal protection. Pivot base with bracket for four-point mounting.</p> <p>LED work light with glass lens, 3000 lm and lens pattern for close-range illumination</p>
8KB 990 299-011	1	<p>Accessories: 2000 mm long connecting lead for DEUTSCH plug connector with cap</p>
1GA 996 192-051	1	<p>For upright mounting. With handle. Spigot mount 24 mm dia. with integrated electrical contacts.</p> <p>LED work light with plastic lens, 3000 lm and lens pattern for close-range illumination</p>
1GA 996 192-181	1	<p>For upright mounting. With lead and 2-pole AMP plug connector in the spigot. With spigot mount 24 mm dia.</p> <p>LED work light with plastic lens, 3000 lm and lens pattern for close-range illumination</p>

External-fitting work lights

Power Beam 3000

With 16 Power LEDs. Light aperture: 83 x 83 mm.

16-part reflector made of plastic, glued to pattern-free lens.

Black finish aluminium body with cooling ribs.

Rear of body made of silver plastic.

Without vibration dumping.

Voltage range: 12V - 24V, 43W. Type of protection: IP6K7 and IP6K9K.

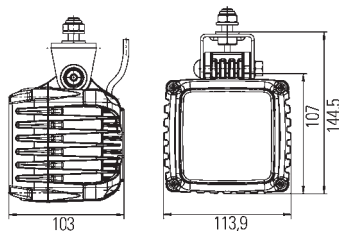
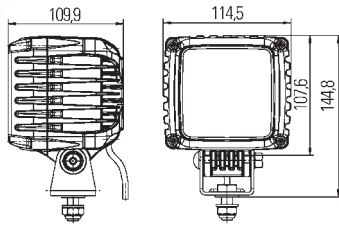

Part no.	Pk.	
		For upright mounting. With 2000 mm long lead. Pivot base made of stainless steel with M10 fixing screw.
1GA 996 192-001	1	LED work light with glass lens, 3000 lm and lens pattern for close-range illumination
		For upright mounting. With 2-pole DEUTSCH plug connector and polarity reversal protection. Pivot base made of stainless steel with M10 fixing screw.
1GA 996 192-061	1	LED work light with glass lens, 3000 lm and lens pattern for close-range illumination
8KB 990 299-011	1	Accessories: 2000 mm long connecting lead for DEUTSCH plug connector with cap
		For upright mounting. With 2000 mm long lead. Pivot base made of stainless steel with M10 fixing screw.
1GA 996 192-011	1	LED work light with glass lens, 3000 lm and lens pattern for long-range illumination
		For mounting. With 2000 mm long lead. Pivot base made of stainless steel with M12 fixing screw.
1GA 996 192-021	1	LED work light with plastic lens, 3000 lm and lens pattern for close-range illumination
		For pendant mounting. With 2000 mm long lead. Pivot base made of stainless steel with M10 fixing screw.
1GA 996 192-041	1	LED work light with plastic lens, 3000 lm and lens pattern for close-range illumination
9XD 990 298-031	1	Accessories: Angular bracket

External-fitting work lights

Power Beam 5000

With 23 Power LEDs. Light aperture: 145 x 125 mm.

23-part reflector made of plastic, glued to pattern-free lens.

Black finish aluminium body with cooling ribs.

Rear of body made of black plastic.

With vibration damping.

Voltage range: 12V - 24V, 68W. Type of protection: IP6K7 and IP6K9K.

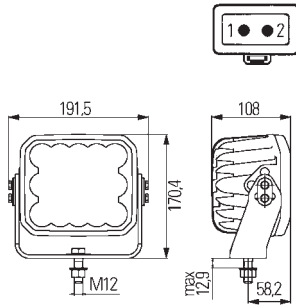

Part no.	Pk.	
		For upright mounting. Heavy Duty pivot base with M12 fixing screw.
1GB 996 194-001	1	LED work light, 4500 lm, with 2-pole AMP plug connector, polarity reversal protection, plastic lens and lens pattern for close-range illumination
1GB 996 194-011	1	LED work light, 4500 lm, with 200 mm long lead, polarity reversal protection, plastic lens and lens pattern for close-range illumination
1GB 996 194-041	1	LED work light, 4500 lm, with 2000 mm long lead with stripped ends, polarity reversal protection, plastic lens and lens pattern for close-range illumination
		Accessories:
8KB 990 299-011	1	2000 mm long connecting lead for DEUTSCH plug connector with cap

External-fitting work lights for upright or pendant mounting

AP 700 - 1800 LED

Lens pattern for close-range illumination.
 With 300 mm long lead. Light aperture: \varnothing 135 mm.
 Hardened lens with optical pattern.
 Black aluminium body with cooling ribs.
 Pivot base with M10 fixing screw.
 Voltage range: 12V - 24V.
 Type of protection: IP6K7 and IP6K9K.

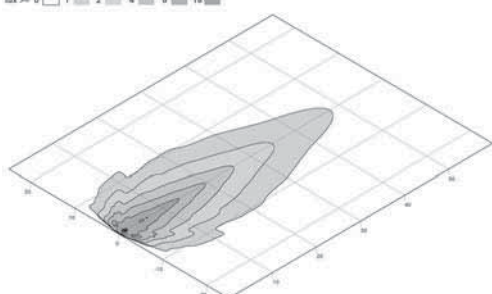
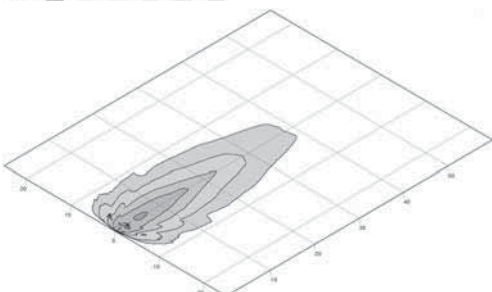
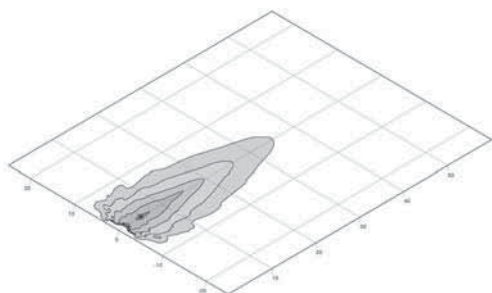
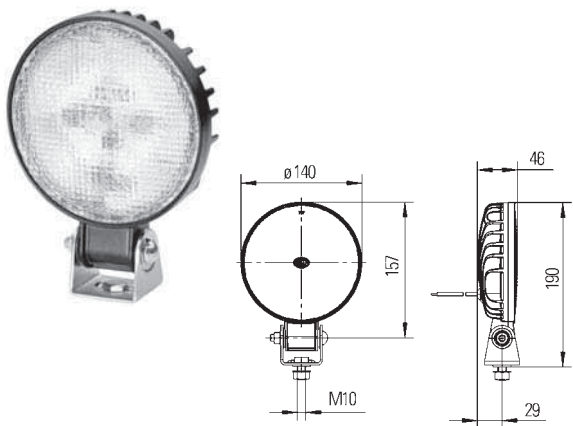

Part no.	Pk.	
1G4 012 722-001	1	LED work light with 3 Power LEDs, 16W, 700 lm
1G4 011 722-001	1	with 4 Power LEDs, 22W, 1200 lm
1G4 013 722-001	1	with 6 Power LEDs, 30W, 1800 lm

External-fitting work lights

AP 1200 LED

Lens pattern for close-range illumination.
With 4 Power LEDs. Light aperture: 120 x 120 mm.
 Hardened glass with optical pattern.
 Black finish aluminium body with cooling ribs.
 Pivot base with M10 fixing screw.
 Voltage range: 12V - 24V, 22W.
 Type of protection: IP6K7 and IP6K9K.

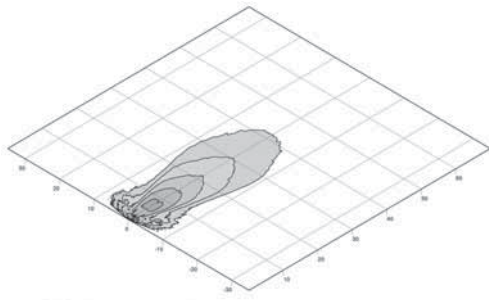

lux >> 0 1 2 4 8 16

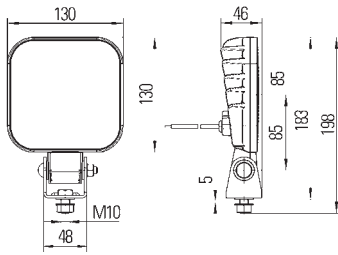

Part no.	Pk.	
1GA 011 720-041	1	For upright mounting. With 300 mm long lead. LED work light, 1200 lm

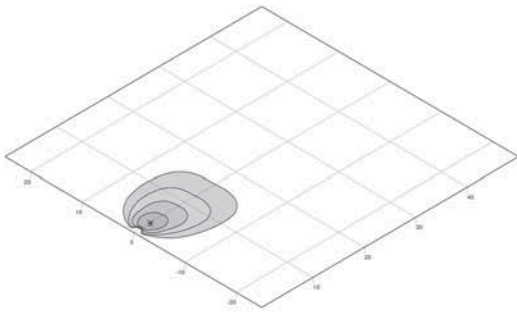

lux >= 0 1 2 4 8

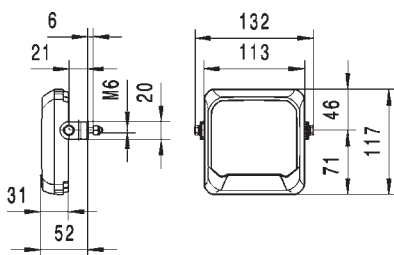
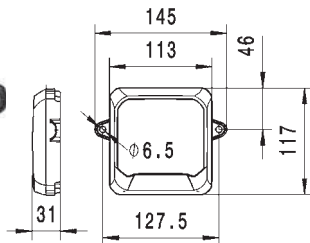
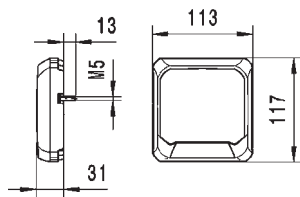
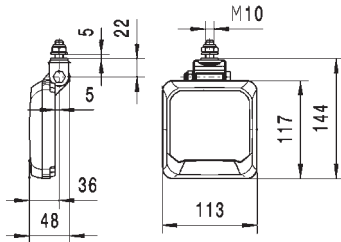
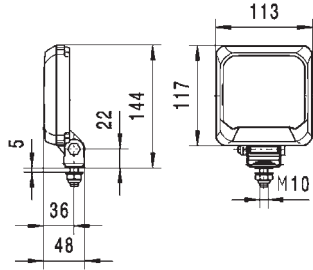

External-fitting work lights

Flat Beam 500

Lens pattern for close-range illumination.
 With 30 LEDs and 2000 mm long lead. Light aperture: 95 x 80 mm.
 Reflector made of plastic, glued to plastic lens.
 Black shiny, hardened plastic body.
 With polarity reversal protection.
 Voltage range: 12V - 24V, 7W.
 Type of protection: IP67 and IP6K9K.

Part no.	Pk.	
1GA 995 193-001	1	LED work light, 550 lm, for upright mounting
1GA 995 193-011	1	for pendant mounting
1GA 995 193-021	1	attachment rear with 2 square fixing screws M5
1GA 995 193-031	1	for side mounting with two 6.5 mm dia. holes for fixing screws
1GA 995 193-041	1	with bracket and two fixing screws M6

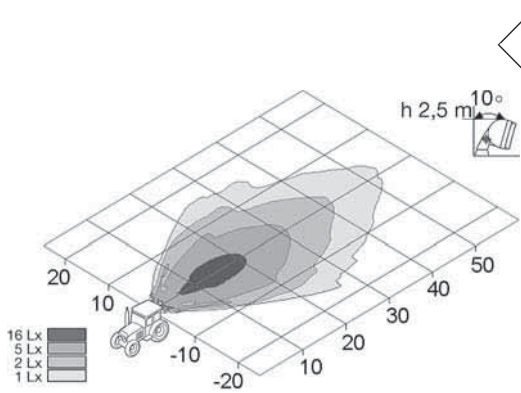
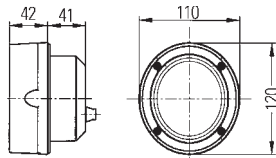
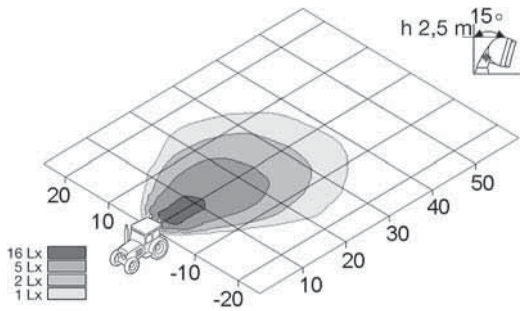

Built-in work lights

Mega Beam with FF reflector

Light aperture: 83 x 92 mm.

Reflector made of diecast aluminium, glued to hardened glass lens.
Body and cover ring grey.

Black plastic lens-retaining rim with extending edge to protect lens.

With four 3.9 x 50 mm fixing screws. Distance between screws: 70 x 70 mm.

Mounting area: 83 x 93 mm. Type of protection: IP5K4K.

Part no.	Pk.	
1GM 996 134-311	1	<p>Lens pattern for wide ground illumination. Recommended angle of inclination: 15° - 25°.</p> <p>FF H3 work light with 2-pole AMP plug connector and protection cap</p> <p>Spare parts/Accessories: H3 bulb, 12V35W 12V55W 24V70W Cap for AMP plug connector</p>
1GM 996 134-091	1	<p>Lens pattern for off-road illumination. Recommended angle of inclination: 10° - 15°.</p> <p>FF H3 work light with grommet</p> <p>Spare parts/Accessories: H3 bulb, 12V35W 12V55W 24V70W</p>

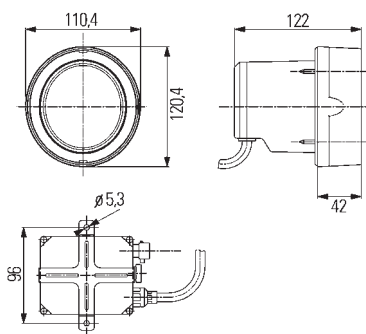
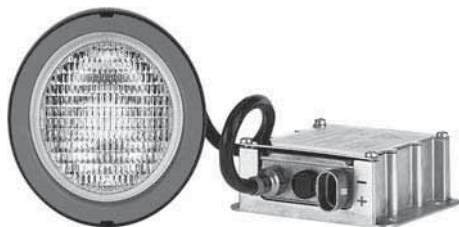
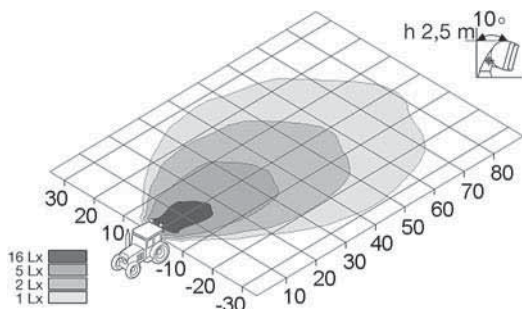

Built-in work lights

Mega Beam Xenon

Lens pattern for close-range illumination.

With gas discharge bulb. Light aperture: 83 x 92 mm.

Recommended angle of inclination: 10° - 15°.

Reflector made of diecast aluminium, glued to hardened glass lens.

Red body and screw cover rim. Black lens-retaining rim.

Without connecting lead.

Work light permanently connected to ballast unit 42W by a 310 mm long lead.

Type of protection: IP5K4K.

Part no.	Pk.	
1GM 996 135-551	1	Xenon work light with 24V ballast unit
8GS 007 949-261	1	Spare parts: D2S gas discharge bulb, 35W
5DV 990 264-011	1	Ballast unit, 24V



External-fitting work lights for upright mounting

Mega Beam Xenon

With gas discharge bulb. Light aperture: 83 x 92 mm.

Recommended angle of inclination: 10° - 15°.

Reflector made of diecast aluminium, glued to hardened glass lens.

Black plastic body and lens-retaining rim, red plastic cover rim with extending edge to protect lens.

Pivot base with vibration damping and bracket for four-point mounting made of stainless steel.

Pivot range vertical 70°.

Work light permanently connected to ballast unit 42W by a 300 mm long lead.

With 3700 mm long connecting lead, relay and 15A fuse.

Type of protection: IP5K4K.

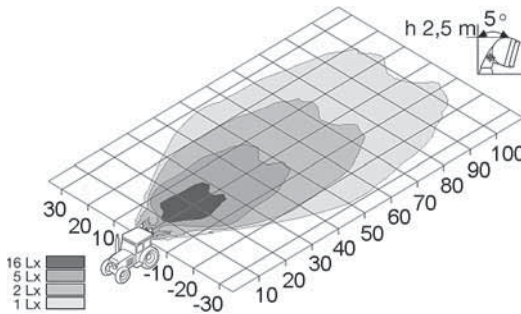
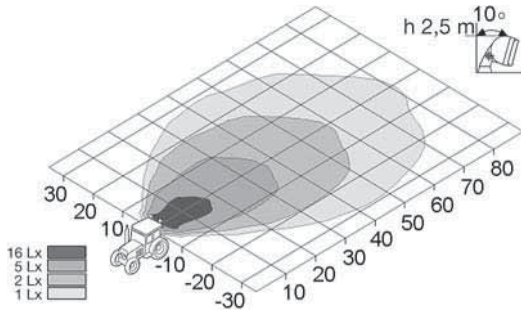
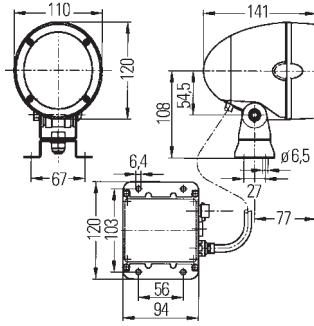

Part no.	Pk.	
1GM 996 135-041	1	Xenon work light with lens pattern for close-range illumination and 24V ballast unit
1GM 996 135-051	1	Xenon work light with lens pattern for long-range illumination and 24V ballast unit
8GS 007 949-261	1	Spare parts: D2S gas discharge bulb, 35W
5DV 990 264-001	1	Ballast unit, 12V
5DV 990 264-011	1	24V
8KB 149 147-001	1	3000 mm long connecting lead from ballast unit to battery, with relay and fuse, 12V

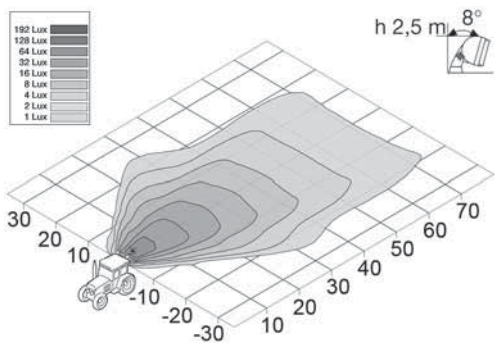

External-fitting work lights

Mega Beam Xenon

Lens pattern for close-range illumination.

With gas discharge bulb. Light aperture: 83 x 92 mm.

Recommended angle of inclination: 3° - 10°.

Reflector made of diecast aluminium, glued to hardened glass lens.

Black plastic body and red lens-retaining rim with extending edge to protect lens.

Rear of body made of black diecast aluminium.

Work light permanently connected to ballast unit by a 500 mm long lead.

Vibration-damped pivot base with bracket for four-point mounting.

Type of protection: IP5K9K. System capacity: 50W.

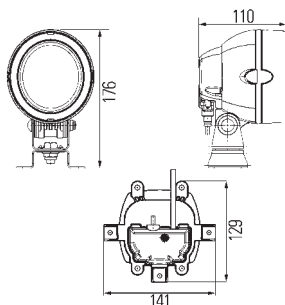
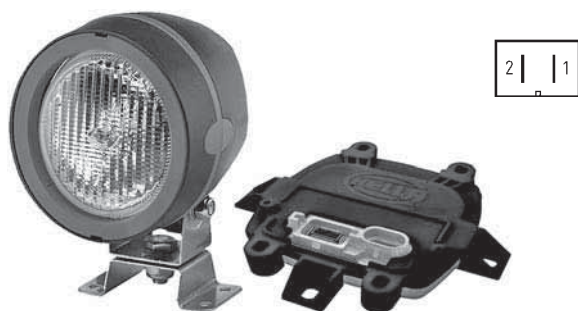

Part no.	Pk.	
1GM 996 135-361	1	Xenon work light with 100 mm long lead and 2-pole AMP plug connector, for upright mounting, with 12V ballast unit
8GS 009 028-111	1	Spare parts: D1S gas discharge bulb, 35W

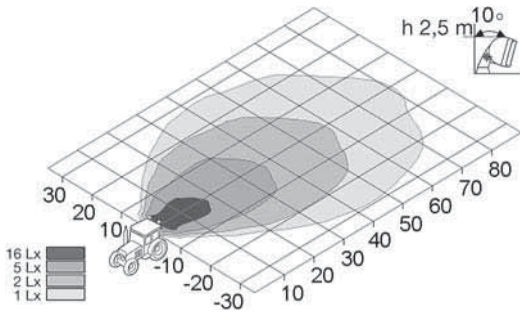

External-fitting work lights

Mega Beam Xenon-Powerpack

Lens pattern for close-range illumination.
With gas discharge bulb, 500 mm long lead and 2-pole AMP plug
Light aperture: 83 x 92 mm.
 Recommended angle of inclination: 3° - 10°.
 Reflector made of diecast aluminium, glued to hardened glass lens.
 Black plastic body and red lens-retaining rim with extending edge to protect lens.
 Rear of body made of black die-cast aluminium.
 Xenon electronic unit 42W integrated into body.
 Vibration-damped pivot base with bracket for four-point mounting.
 Additionally enclosed, displaceable bracket for single-point attachment.
 Type of protection: IP5K4K.

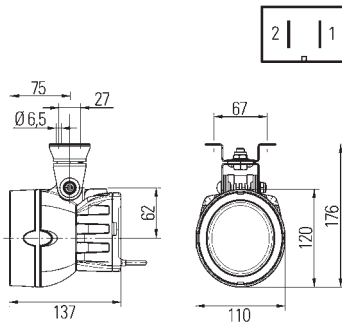
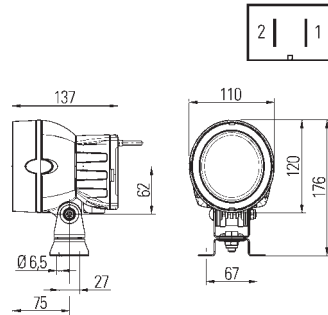

Part no.	Pk.	
1GM 996 135-231	1	Xenon work light for upright mounting, with 12V ballast unit
1GM 996 135-251	1	with 24V ballast unit
1GM 996 135-241	1	Xenon work light for pendant mounting, with 12V ballast unit
1GM 996 135-261	1	with 24V ballast unit
8GS 009 028-111	1	Spare parts: D1S gas discharge bulb, 35W

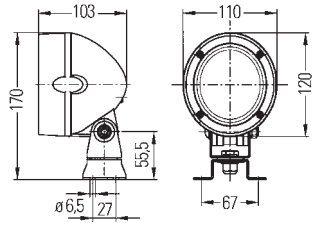

External-fitting work lights for upright or pendant mounting

Mega Beam with FF reflector

Light aperture: 83 x 92 mm.

Reflector made of diecast aluminium, glued to hardened glass lens. Grey body and cover rim. Black lens-retaining rim with extending edge to protect lens.

Pivot base with vibration damping and bracket for four-point mounting.

Pivot range vertical 145°.

Type of protection: IP5K4K and IPX9K.

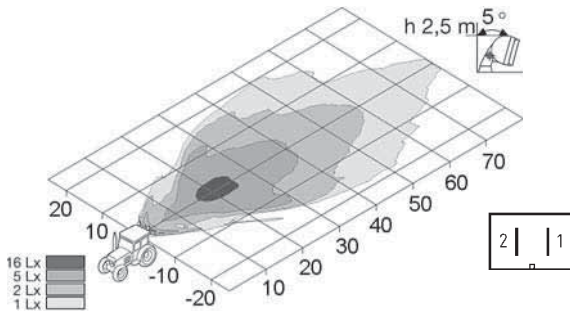
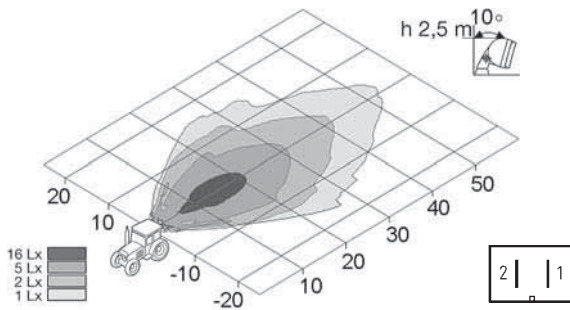
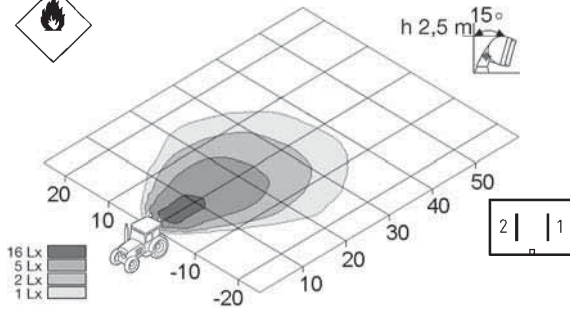

Part no.	Pk.	
1GM 996 134-321	1	FF H3 work light lens pattern for long-range ground illumination. recommended angle of inclination: 15° - 25°, with grommet
1GM 996 134-171	1	with 2-pole AMP plug connector and protection cap
1GM 996 134-061	1	FF H3 work light with lens pattern for ground illumination. recommended angle of inclination: 10° - 15°, with grommet and lens without optical pattern
1GM 996 134-081	1	with lens without optical pattern, 2-pole AMP plug connector and cap
1GM 996 134-051	1	FF H3 work light with lens pattern for long-range illumination, recommended angle of inclination: 2° - 5°, with grommet and lens without optical pattern
1GM 996 134-071	1	with lens without optical pattern, 2-pole AMP plug connector and cap
Spare parts/Accessories:		
9GH 993 984-001	20	Cap for AMP plug connector
9XD 990 298-001	5	Bracket for four-point fixing
8GH 002 090-271	1	H3 bulb, 12V35W
8GH 002 090-133	1	12V55W
8GH 002 090-251	1	24V70W
8JD 008 151-011	10	Socket for AMP plug connector
8KW 701 235-033	100	Blade receptacles, 6.3 mm
8HG 990 263-111	1	Mounting bracket for tubular mount on 15 mm - 28 mm dia. pipes
8KB 990 299-001	1	2000 mm long connecting lead for AMP plug connector with cap

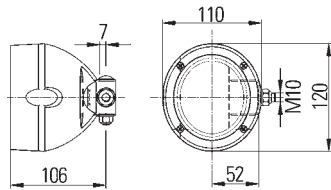
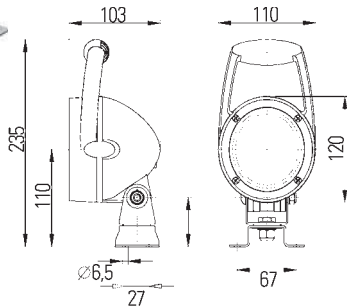
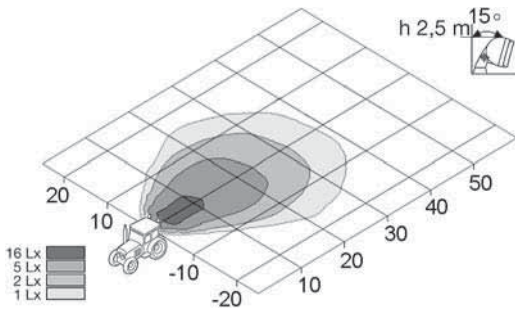

External-fitting work lights

Mega Beam with FF reflector

Lens pattern for wide ground illumination.

With grommet. Light aperture: 83 x 92 mm.

Recommended angle of inclination: 15° - 25°.

Reflector made of diecast aluminium, glued to hardened glass lens.

Grey plastic body and cover rim, black plastic lens-retaining rim with extending edge to protect lens.

Type of protection: IP5K4K and IPX9K.

Part no.	Pk.	
1GM 996 134-241	1	FF H3 work light with handle, pivot range vertical 145°, pivot base with vibration damping and mounting bracket for four-point mounting for upright or pendant mounting
1GM 996 134-271	1	FF H3 work light without vibration damping. Pivot range vertical 90°, inclination range horizontal 170°. With pivoting base at the side and M10 fixing screw for mounting on vertical surfaces, left
1GM 996 134-371	1	right
8GH 002 090-271	1	Accessories: H3 bulb,
8GH 002 090-133	1	12V35W
8GH 002 090-251	1	12V55W
		24V70W
8HG 990 263-111	1	Mounting bracket for tubular mount on
9XD 990 298-031	1	15 mm - 28 mm dia. pipes
		Angular bracket (except -241)

External-fitting work lights

Mega Beam LED

Lens pattern for close-range illumination.

With 4 LEDs. Light aperture: 83 x 92 mm.

Recommended angle of inclination: 10° - 15°.

4-part reflector glued to pattern-free glass lens.

Black finish aluminium body with cooling ribs.

Black lens-retaining rim. Blue plastic cover- and intermediate ring.

Pivot base with M10 fixing screw. With 2000 mm long connection lead.

Type of protection: IP6K9K, IP6K7.

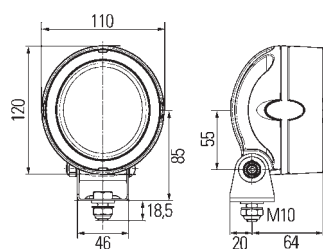

Part no.	Pk.	
1GM 996 136-131	1	LED work light, 180 lm. Voltage range: 36V - 80V, 7W, for upright mounting
1GM 996 136-192	1	LED work light, 600 lm Voltage range: 12V - 24V, 15W for upright mounting, Self-service box
1GM 996 136-311	1	LED work light, 800 lm. Voltage range: 12V - 24V, 13W, for upright mounting
1GM 996 136-312	1	LED work light, 800 lm. Voltage range: 12V - 24V, 13W, for upright mounting, Self-service box
1GM 996 136-361	1	for pendant mounting

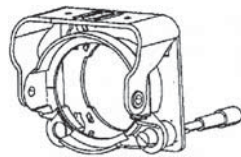
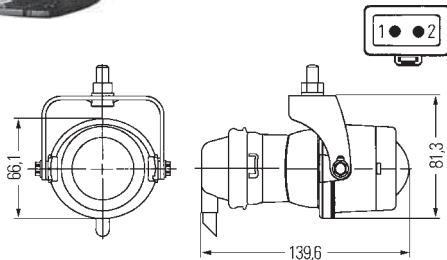
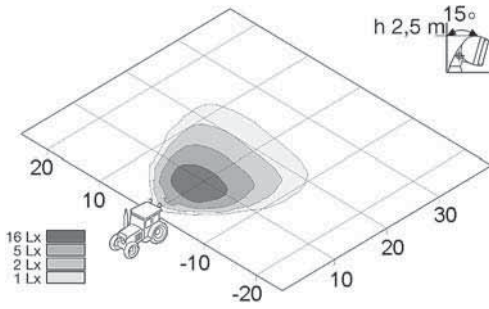

External-fitting work lights

Micro DE

Lens pattern for close-range illumination.

Light aperture: Ø 40 mm.

Recommended angle of inclination: 15° - 20°.

Black body and lens-retaining rim.

Lens with body and supporting frame bonded.

Black bracket with M8 fixing screw.

Part no.	Pk.	
1GL 008 090-201	1	DE H3 work light
1GL 008 090-207	60	with rubber cap for lead entry and 12V55W bulb
1GL 008 090-211	1	with rubber cap for lead entry and 24V70W bulb
1GL 008 090-217	60	with rubber cap for lead entry and 24V70W bulb
1GL 008 090-287	60	with lead, 2-pole DEUTSCH plug connector and 24V70W bulb
Spare parts/Accessories:		
8GH 002 090-271	1	H3 bulb,
8GH 002 090-133	1	12V35W
8GH 002 090-251	1	12V55W
9GH 147 009-007	30	24V70W
9HD 149 253-007	1	Rubber cap for lead entry
8JD 156 150-807	1	Plastic sealing cap with plug
	1	Delphi socket set, 2-pole (20 pcs.)
8HG 153 152-001	1	Convenience mount with adjustment screw

External-fitting work lights for upright mounting

Module 50 LED

With 1 Power LED and 2-pole DEUTSCH plug connector.

Light aperture: 35 mm dia.

Reflector made of plastic.

Black body made of diecast aluminium, glued to plastic lens.

Pivot base with M8 fixing screw.

Voltage range: 12V - 24V, 15W.

Type of protection: IP6K9K, IP6k7.

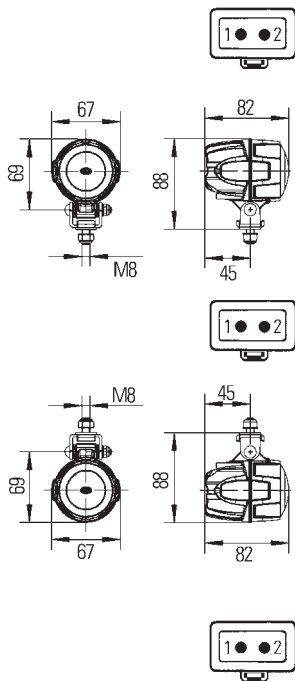

Part no.	Pk.	
1G0 995 050-001	1	LED work light, 700 lm, with lens pattern for close-range illumination, recommended angle of inclination: 12°, for upright mounting
1G0 995 050-011	1	for pendant mounting
1G0 995 050-021	1	LED work light, 700 lm, with lens pattern for long-range illumination, recommended angle of inclination: 5°, for upright mounting

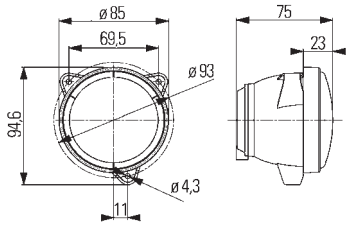

Built-in work lights

Module 70 H3

Light aperture: 77 mm dia.

Reflector made of diecast aluminium, glued to hardened glass lens.
 Black plastic body with three-point mounting.
 With rubber cap to cover the bulb and for lead entry.
 Type of protection: IP5K4K.

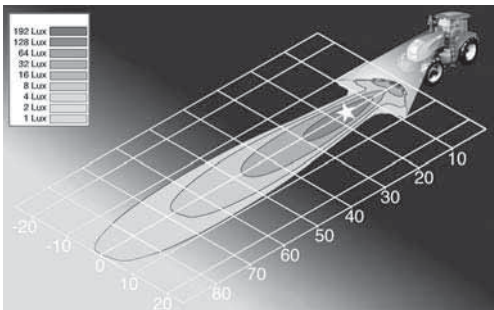
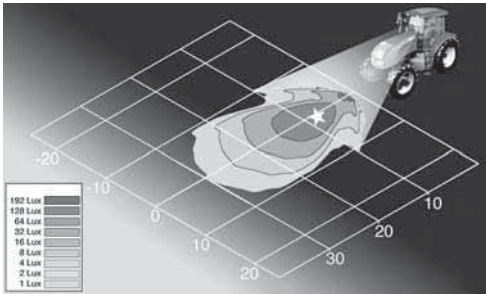

Part no.	Pk.	
1G0 996 176-021	1	H3 work light without bulb, with lens pattern for close-range illumination
1G0 996 276-767	36	with 24V70W bulb, 200 mm long lead with 2-pole DEUTSCH plug connector and lens pattern for close-range illumination
1G0 996 176-031	1	without bulb, with lens pattern for long-range illumination
9HD 990 101-001	2	Spare parts/Accessories: Rubber sealing cap
8GH 002 090-271	1	H3 bulb, 12V35W
8GH 002 090-133	1	12V55W
8GH 002 090-251	1	24V70W

External-fitting work lights

Module 70 H3

Without bulb. Light aperture: 77 mm dia.

Reflector made of diecast aluminium, glued to hardened glass lens.
Black plastic body.

Pivot base with M10 fixing screw.

With rubber cap to cover the bulb.

Type of protection: IP5K4K.

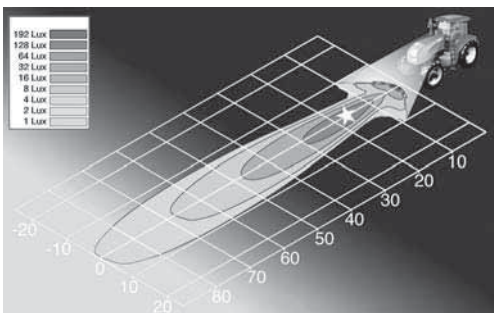
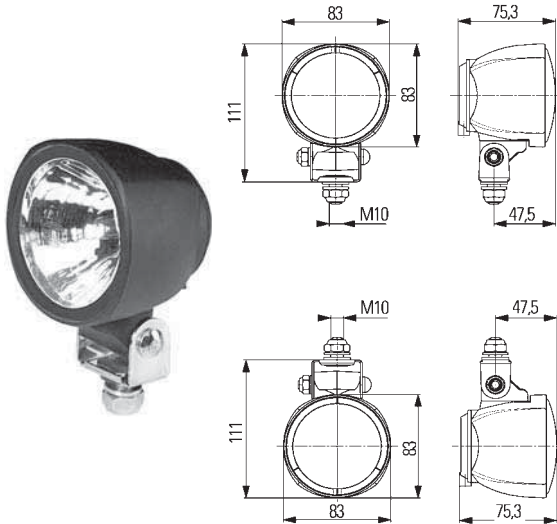
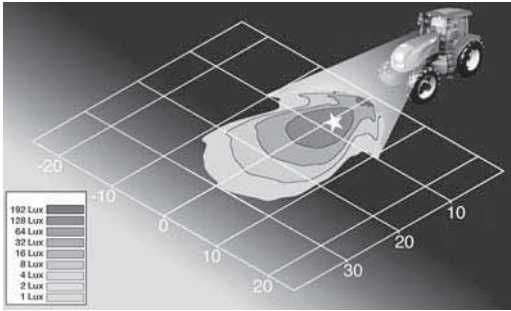

Part no.	Pk.	
1G0 996 176-001	1	H3 work light with lens pattern for close-range illumination, recommended angle of inclination: 10° - 20°, for upright mounting
1G0 996 176-007	24	
1G0 996 176-002	18	Self-service box
1G0 996 176-111	1	H3 work light with lens pattern for close-range illumination, recommended angle of inclination: 10° - 20°, for pendant mounting
1G0 996 176-112	18	
1G0 996 176-011	1	H3 work light with lens pattern for long-range illumination, recommended angle of inclination: 5° - 10°, for upright mounting
1G0 996 176-121	1	for pendant mounting
Spare parts/Accessories:		
9HD 990 101-001	2	Rubber sealing cap
9XD 990 298-001	5	Bracket for four-point fixing
8HG 990 263-111	1	Mounting bracket for tubular mount on 15 mm - 28 mm dia. pipes
8GH 002 090-271	1	H3 bulb, 12V35W
8GH 002 090-133	1	12V55W
8GH 002 090-251	1	24V70W

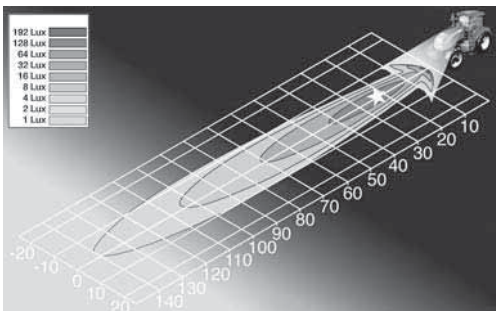
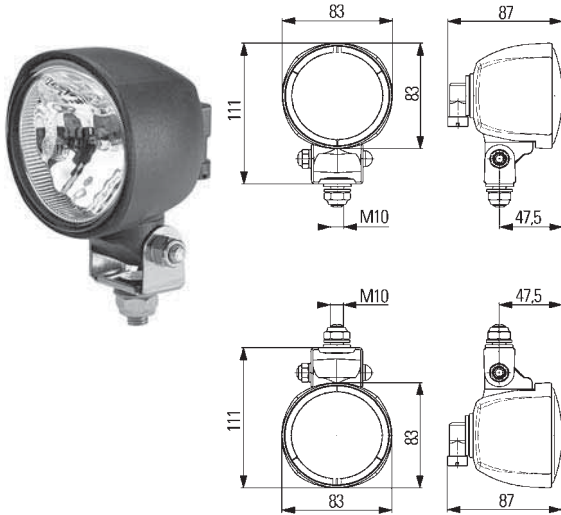
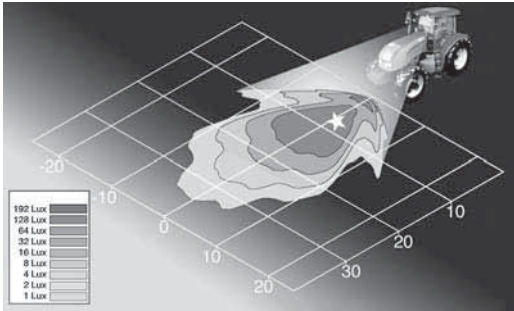

External-fitting work lights

Module 70 H9

With 12V bulb, accessible from the outside.

Light aperture: 77 mm dia.

Reflector made of diecast aluminium, glued to hardened glass lens.

Black plastic body.

Pivot base with M10 fixing screw.

With rubber cap to cover the bulb and for lead entry.

Part no.	Pk.	
		Type of protection: IP5K9K. H9 work light with lens pattern for close-range illumination, recommended angle of inclination: 10° - 20°, for upright mounting
1G0 996 176-041	1	
1G0 996 176-131	1	for pendant mounting
1G0 996 176-137	350	
		with 2000 mm long connecting lead and H9 plug, for upright mounting
1G0 996 176-171	1	
		with 2000 mm long connecting lead and H9 plug, for pendant mounting
1G0 996 176-181	1	
		Type of protection: IP5K4K. H9 work light with lens pattern for close-range illumination, recommended angle of inclination: 10° - 20°, for pendant mounting
1G0 996 276-187	24	
		Type of protection: IP5K9K. H9 work light with lens pattern for long-range illumination, recommended angle of inclination: 5° - 10°, for upright mounting
1G0 996 176-051	1	
		with blue lens, for upright mounting
1G0 996 176-671	1	
1G0 996 176-141	1	for pendant mounting
		Spare parts/Accessories:
8GH 008 357-001	1	H9 bulb, 12V65W
9XD 990 298-001	5	Bracket for four-point fixing
8HG 990 263-111	1	Mounting bracket for tubular mount on 15 mm - 28 mm dia. pipes
8KB 990 299-311	1	2000 mm long connecting lead, with plug for connecting the H9 bulb
9GH 990 334-011	1	Rubber cap for H9 socket

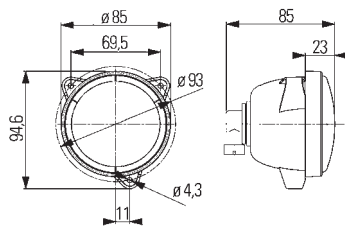
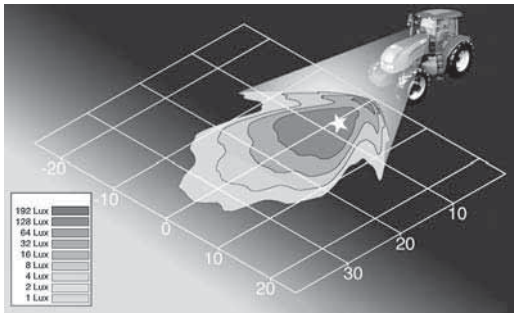

Built-in work lights

Module 70 H9

Lens pattern for close-range illumination.
With 12V bulb. Light aperture: 77 mm dia.

Reflector made of diecast aluminium, glued to hardened glass lens.
 Black plastic body with three-point fixing.
 With rubber cap to cover the bulb and for lead entry.
 Type of protection: IP5K9K.

Part no.	Pk.	
1G0 996 176-061	1	H9 work light
8GH 008 357-001	1	Spare parts/Accessories: H9 bulb, 12V65W
8KB 990 299-311	1	2000 mm long connecting lead, with plug for connecting the H9 bulb
9GH 990 334-011	1	Rubber cap for H9 socket

External-fitting work lights

Module 70 Xenon

Lens pattern for close-range illumination.
With gas discharge bulb.
Light aperture: 77 mm dia.

Recommended angle of inclination: 10° - 20°.
 Reflector made of diecast aluminium,
 glued to hardened glass lens. Black plastic body.
 Pivot base with M10 fixing screw.
 Work light connected to ballast unit by a 500 mm long lead,
 separated by a plug connection on the ballast unit.
 Without lead. Type of protection: IP5K9K. System capacity: 50W.

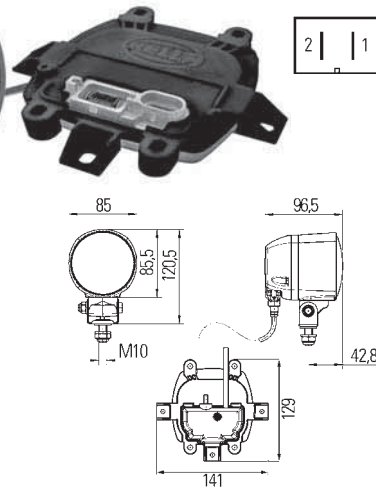
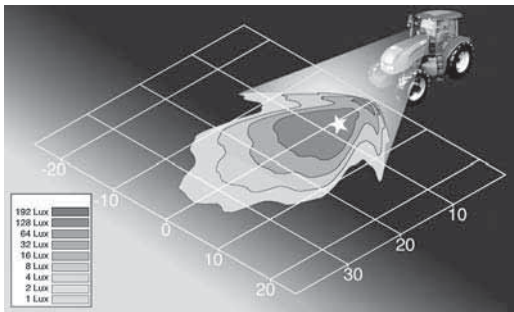

Part no.	Pk.	
1G0 996 176-621	1	Xenon work light with 2-pole AMP plug connector and 12V ballast unit
8GS 009 028-111	1	Spare parts/Accessories: D1S gas discharge bulb, 35W
8KB 990 299-001	1	2000 mm long connecting lead for AMP plug connector with cap

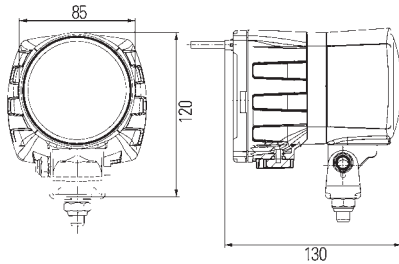
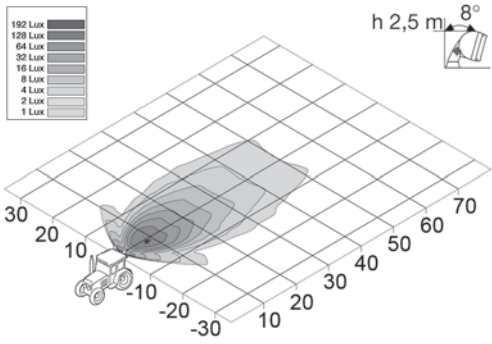

External-fitting work lights for upright mounting

Module 70 Xenon Powerpack

Lens pattern for close-range illumination.

With 500 mm long lead, 2-pole AMP plug connector and gas discharge bulb. Light aperture: 77 mm dia.

Reflector made of die-cast aluminium, glued to hardened glass lens.

Black plastic body,

rear of body made of diecast aluminium.

Pivot base with M10 fixing screw.

Xenon electronic unit integrated into body.

Part no.	Pk.	
1G0 996 176-681	1	Xenon work light with 12V ballast unit
1G0 996 176-691	1	with 24V ballast unit
8GS 009 028-111	1	Spare parts: D1S gas discharge bulb, 35W

External-fitting work lights for pendant mounting

Module 70 Xenon

For long-range illumination.

With 2-pole AMP plug connector and gas discharge bulb.

Light aperture: 77 mm dia.

Reflector made of die-cast aluminium, glued to hardened glass lens.

Black plastic body,

rear of body made of diecast aluminium.

Pivot base with M10 fixing screw.

Xenon electronic unit integrated into body.

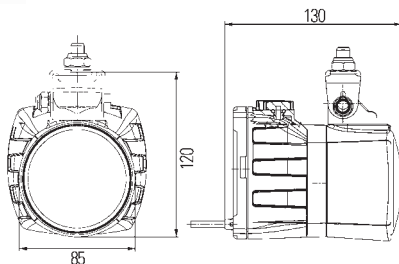

Part no.	Pk.	
1G0 996 276-357	1	Xenon work light with 12V ballast unit
8GS 009 028-111	1	Spare parts: D1S gas discharge bulb, 35W

Built-in work lights

Module 70 LED

Lens pattern for close-range illumination.
With 4 Power LEDs, 1500 mm long lead and
2-pole AMP Superseal plug connector.
Light aperture: 77 mm dia.

4-part reflector made of plastic, glued to glass lens without optical pattern.
 Black aluminium body with cooling ribs.
 Voltage range: 12V - 24V.
 Type of protection: IP6k7, IP6K9K.

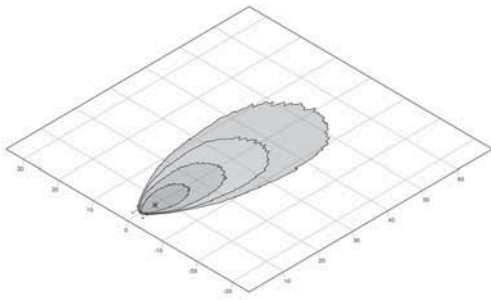

Beam = 0 1 2 4 8

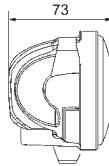
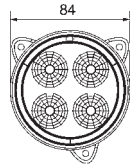

Part no.	Pk.	
1G0 996 376-141	1	LED work light, 13W, 800 lm

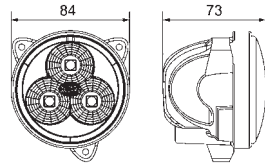

Built-in work lights

Module 70 LED

With 3 Power LEDs and 2000 mm long lead with stripped ends.
Light aperture: 70 mm dia.

3-part reflector made of plastic, glued to hardened glass lens without optical pattern.

Black aluminium body with cooling ribs.

Voltage range: 12V - 24V. Type of protection: IP6K7, IP6K9K.

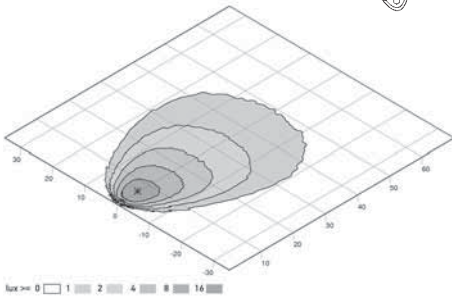

lux >= 0 1 2 4 8 16

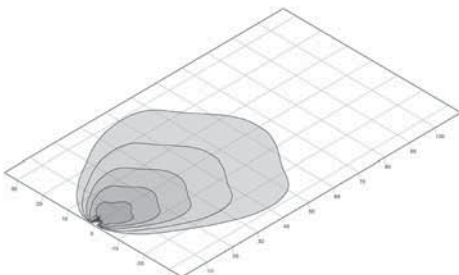

lux >= 0 1 2 4 8 16

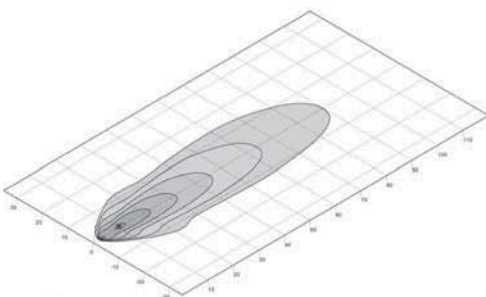

lux >= 0 1 2 4 8 16 32

Part no.	Pk.	
1G0 996 476-121	1	LED work light, 30W, 2500 lm, with lens pattern for close-range illumination
1G0 996 476-131	1	with lens pattern for off-road illumination
1G0 996 476-041	1	with lens pattern for long-range illumination

External-fitting work lights for upright mounting

Module 70 LED

Lens pattern for close-range illumination.

With 4 LEDs, 200 mm long lead and 2-pole AMP plug connector.

Light aperture: 77 mm dia.

4-part reflector made of plastic, glued to glass lens without optical pattern.

Black finish aluminium body with cooling ribs.

Pivot base with M10 fixing screw.

Voltage range: 10V - 100V. Type of protection: IP6K9K.

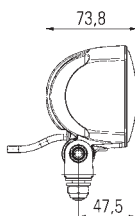
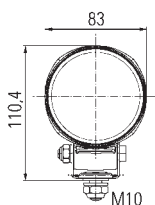

Part no.	Pk.	
1G0 996 276-077	1	LED work light, 15W, 550 lm

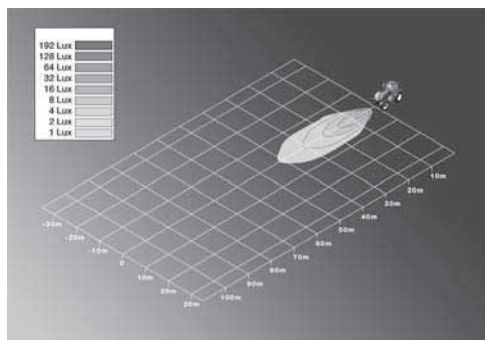

Lens pattern for close-range illumination.

With 4 LEDs. Light aperture: 77 mm dia.

4-part reflector made of plastic, glued to glass lens without optical pattern.

Black plastic body with cooling ribs.

Type of protection: IP6K7, IP6K9K.

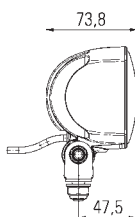
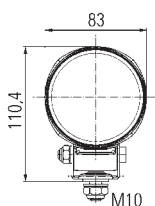

Part no.	Pk.	
1G0 996 376-501	1	LED work light, 12V/13W, 800 lm, with 2000 mm long lead, pivot base with M10 fixing screw for upright mounting

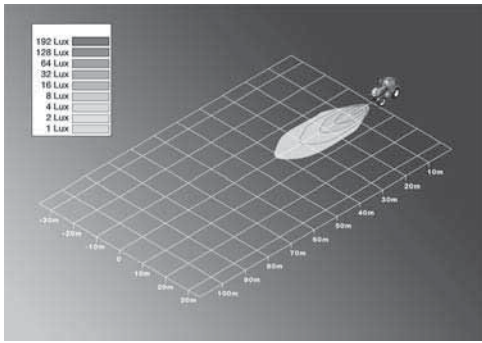

External-fitting work lights

Module 70 LED

Lens pattern for close-range illumination. With 4 LEDs. Light aperture: 77 mm dia.

4-part reflector made of plastic, glued to hardened glass lens without optical pattern.

Black finish aluminium body with cooling ribs.

Voltage range: 12V - 24V.

Type of protection: IP6K9K.

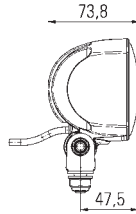
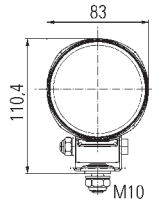

1G0 996 276-481
1G0 996 276-487

1
32

LED work light, 13W, 800 lm, with 2000 mm long lead, pivot base with M10 fixing screw for upright mounting

LED work light, 13W, 800 lm, with 2000 mm long lead, pivot base with M10 fixing screw for upright mounting
Self-service box

LED work light, 13W, 800 lm, with 2000 mm long lead, pivot base with M10 fixing screw for pendant mounting



1G0 996 376-137

1

LED work light, 13W, 800 lm, with 190 mm long lead and 2-pole AMP plug connector, pivot base with M10 fixing screw for upright mounting

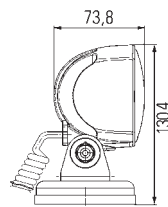
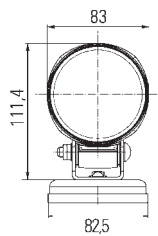
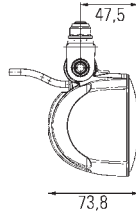
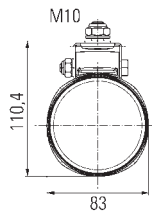

1G0 996 276-631

1

LED work light, 13W, 800 lm, spirally-coiled lead extends up to 3.5 m and 2-pole plug for connecting to cigarette lighter socket, magnet holder for upright mounting

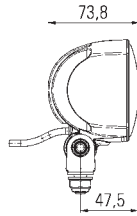
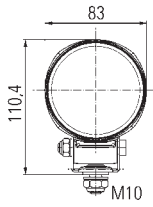
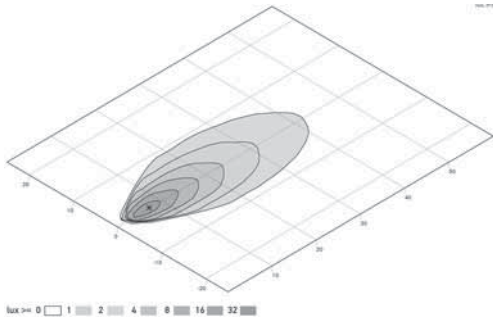

External-fitting work lights

Module 70 LED

For long-range illumination.

With 4 LEDs. Light aperture: Ø 77 mm.

4-part reflector made of plastic, glued to hardened glass lens without optical pattern.

Black finish aluminium body with cooling ribs.

Voltage range: 12V - 24V, 13W.

Type of protection: IP6K7, IP6K9K.

Part no.	Pk.	
1G0 996 276-701	1	LED work light, 13W, 800 lm, with 2000 mm long lead, pivot base with M10 fixing screw for upright mounting

Work lights for upright mounting

Module 70 LED

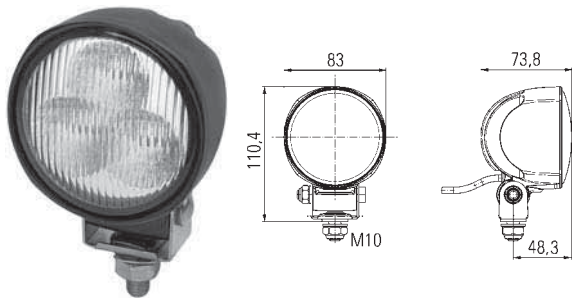

With 3 Power LEDs. Light aperture: 70 mm dia.

3-part reflector made of plastic, glued to hardened glass lens without optical pattern.

Black aluminium body with cooling ribs.

Pivot base with M10 fixing screw.

Voltage range: 12V - 24V.

Type of protection: IP6K7, IP6K9K.

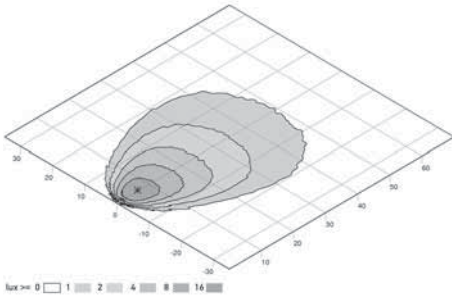

Part no.	Pk.	
1G0 996 476-001	1	LED work light, 30W, 2500 lm, with 2000 mm long lead with stripped ends and lens pattern for close-range illumination
1G0 996 476-231	1	with 190 mm long lead, 2-pole DEUTSCH plug connector and lens pattern for close-range illumination
1G0 996 476-031	1	with 2000 mm long lead with stripped ends and lens pattern for extra wide ground illumination
1G0 996 476-011	1	with 2000 mm long lead and lens pattern for long-range illumination
1G0 996 476-241	1	with 190 mm long lead, 2-pole DEUTSCH plug connector and lens pattern for long-range illumination
1G0 996 476-021	1	with 2000 mm long lead with stripped ends and lens pattern for long-range illumination

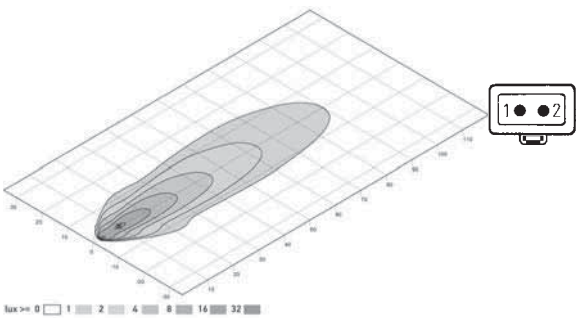
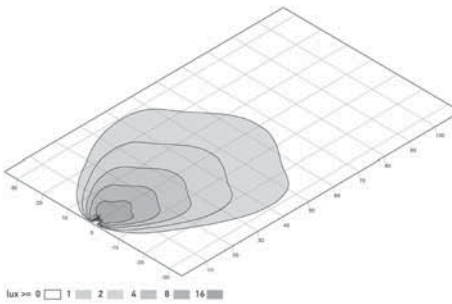

Built-in work lights

Module 90 H9

Lens pattern for close-range illumination.

With 12V bulb. Light aperture: 90 mm dia.

Chrome reflector made of aluminium, glued to pattern-free lens.

Black plastic body with four-point mounting.

With rubber cap to cover the bulb and for lead entry.

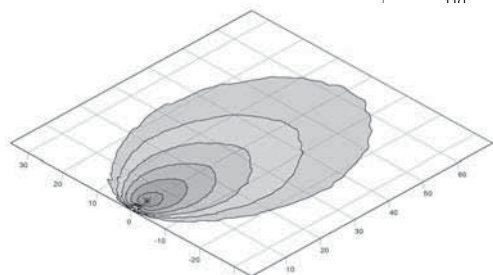
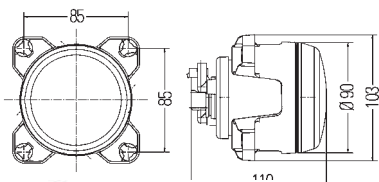

lux >= 0 1 2 4 8 14 32

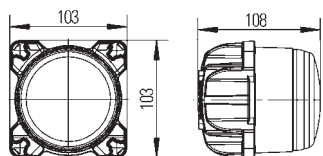

Part no.	Pk.	
1G0 996 163-087	60	H9 work light
Spare parts/Accessories:		
8GH 008 357-001	1	H9 bulb, 12V/65W
8JD 158 175-807	1	H9 socket set (20 pcs.)
9GH 990 334-011	1	Rubber cap for H9 socket

Module 90 LED

With 4 Power Multichip LEDs 36W and 2-pole DEUTSCH plug connector.

Light aperture: 90 mm dia.

High sheen reflector made of plastic glued to plastic lens.

Black finish aluminium housing with four-point mounting.

Voltage range: 12V - 24V.

Type of protection: IP6k7 and IP6K9K.

Part no.	Pk.	
1G0 996 263-501	1	LED work light, 3400 lm with lens pattern for close-range illumination

Built-in work lights

Module 90 LED

Light aperture: 90 mm dia.
 With 12 high-performance LEDs, 36W and 2-pole DEUTSCH plug connector.

High sheen reflector made of plastic glued to plastic lens.
 Black finish aluminium housing with four-point mounting.
 Voltage range: 12V - 24V.
 Type of protection: IP6k7 and IP6K9K.

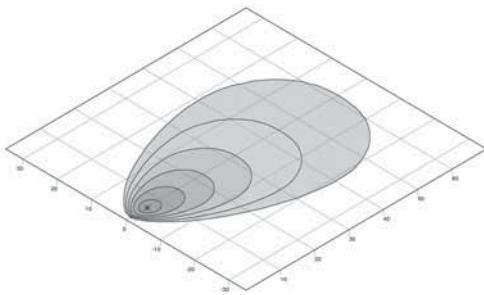

lux >= 0 1 2 4 8 16 32

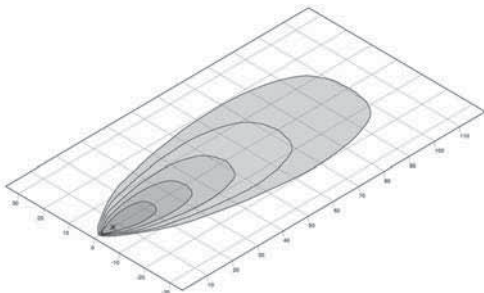

lux >= 0 1 2 4 8 16

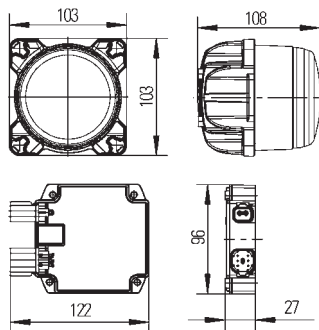

Part no.	Pk.	
1G0 996 263-001	1	LED work light, 2000 lm with lens pattern for close-range illumination
1G0 996 263-011	1	with lens pattern for long-range illumination

Work lights for upright mounting

Module 90 LED

With 4 Power LEDs and 2-pole DEUTSCH plug connector.

Light aperture: 80 mm dia.

High sheen reflector made of plastic glued to plastic lens.

Black finish aluminium body with cooling ribs.

Pivot base with M10 fixing screw.

Voltage range: 12V - 24V, 36W.

Type of protection: IP6K7 and IP6K9K.

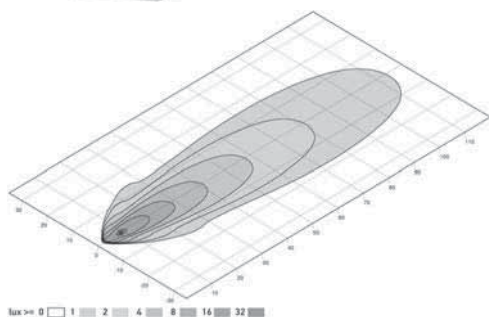
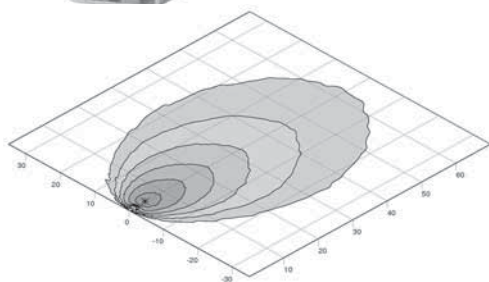
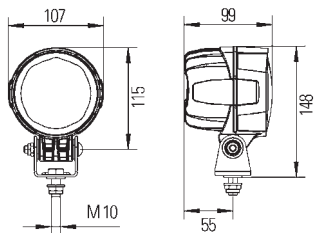

Part no.	Pk.	
1G0 996 263-031	1	LED work light, 3400 lm, with lens pattern for close-range illumination
1G0 996 263-051	1	with lens pattern for long-range illumination

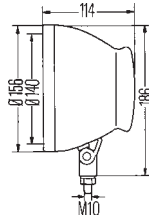
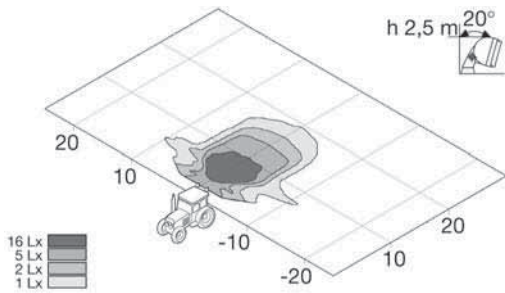

External-fitting work lights for upright or pendant mounting

Proflex-Gladiator

Lens pattern for close-range illumination.

Light aperture: 140 mm dia.

Recommended angle of inclination: 20° - 30°.

Lens with steel reflector bonded.

Flexible rubber body with extending edge to protect lens.

Pivot base with M10 fixing screw.

Type of protection: IP5K4K.

Part no.	Pk.	
1G3 003 710-021	1	H3 work light
Spare parts/Accessories:		
9DS 121 707-001	1	Light unit
9BG 127 179-001	1	Rubber body with universal bracket with fixing screw M10
8GH 002 090-271	1	H3 bulb,
8GH 002 090-133	1	12V35W
8GH 002 090-251	1	12V55W
		24V70W

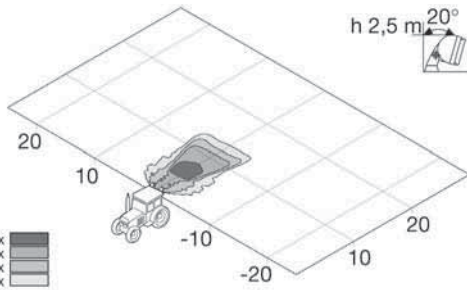

External-fitting work lights for upright or pendant mounting

W131

Lens pattern for close-range illumination. With grommet. Light aperture: 129 mm dia.
 Recommended angle of inclination: 20° - 30°.
 Plastic lens with steel reflector bonded.
 Black plastic body and handle, with extending edge to protect lens.
 Pivot base with M10 fixing screw.
 Without vibration damping.
 Pivot range vertical 105°.

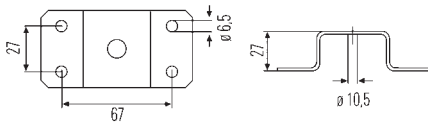
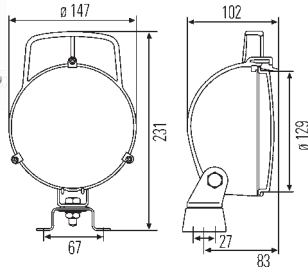

Part no.	Pk.	
1G3 996 001-131	1	F2 work light with switch
1G3 996 001-001	1	without switch
		Spare parts/Accessories:
8GA 002 083-131	1	F2 bulb, 12V35W
8GA 002 083-251	1	24V35W
8HG 990 003-001	2	Bracket for four-point fixing
1G3 996 001-391	1	H3 work light with switch
1G3 996 001-041	1	without switch
		Spare parts/Accessories:
8GH 002 090-271	1	H3 bulb, 12V35W
8GH 002 090-133	1	12V55W
8HG 990 003-001	2	Bracket for four-point fixing

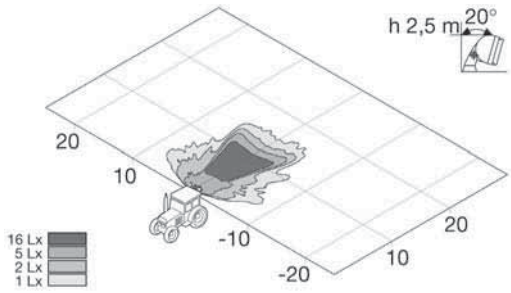

External-fitting work lights for upright or pendant mounting

W131

Lens pattern for close-range illumination. With grommet. Light aperture: 129 mm dia.

Recommended angle of inclination: 20° - 30°.

Plastic lens with steel reflector bonded.

Black plastic body and handle, with extending edge to protect lens.

Pivot base with M10 fixing screw.

Without vibration damping.

Pivot range vertical 105°.

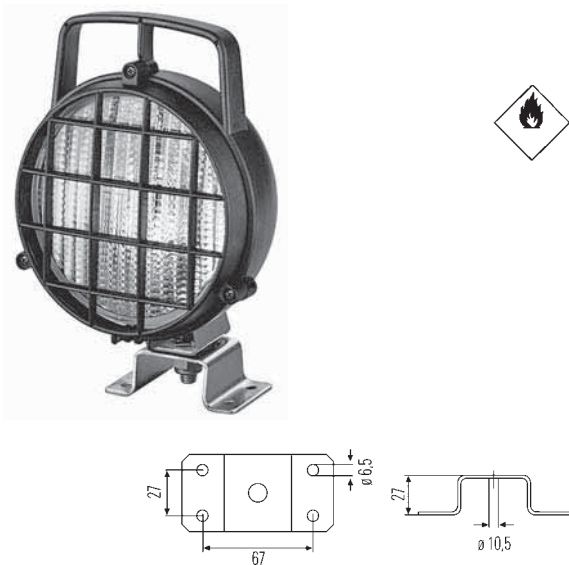
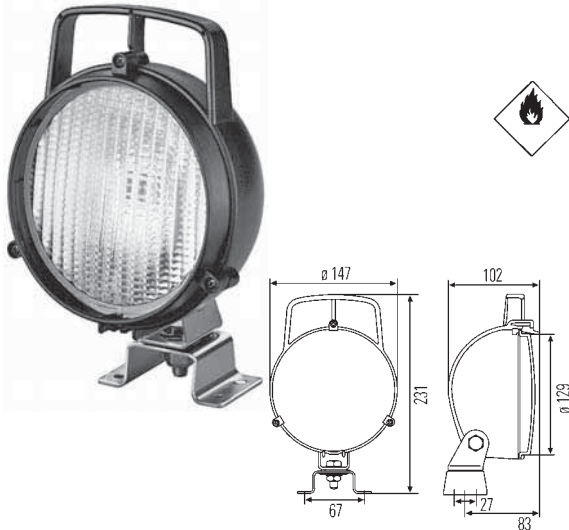

Part no.	Pk.	Description
1G3 996 001-331	1	H3 work light with switch
1G3 996 001-271	1	without switch
Accessories:		
8GH 002 090-271	1	H3 bulb, 12V35W
8GH 002 090-133	1	12V55W
8HG 990 003-001	2	Bracket for four-point fixing
1G3 996 001-351	1	H3 work light with protective grill and switch
1G3 996 001-301	1	with protective grill, without switch
Spare parts/Accessories:		
8GH 002 090-271	1	H3 bulb, 12V35W
8GH 002 090-133	1	12V55W
8GH 002 090-251	1	24V70W
8HG 990 003-001	2	Bracket for four-point fixing

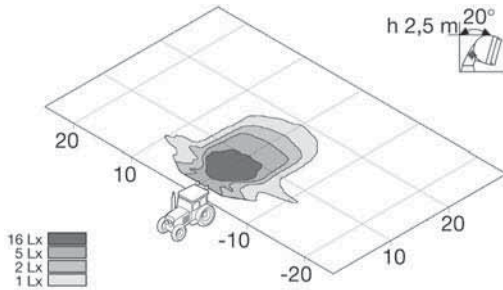

External-fitting work lights for upright or pendant mounting

Matador

Lens pattern for close-range illumination.

With grommet. Light aperture: 140 mm dia.

Recommended angle of inclination: 20° - 30°.

Steel reflector with glass lens bonded.

Black plastic body and protective grille with extending edge to protect lens.

With pivot base, without vibration damping.

Pivot range vertical 130°. Type of protection: IP5K4K.

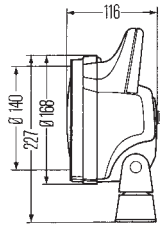

Part no.	Pk.	Description
1G4 003 470-001	1	H3 work light with bracket for four-point mounting, without protective grill, with splash-proof rotary switch
1G4 003 470-011	1	without switch

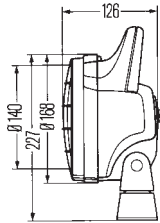

1G4 003 470-031	1	H3 work light with bracket for four-point mounting and protective grill, with splash-proof rotary switch
1G4 003 470-051	1	without switch
Spare parts/Accessories:		
9DS 121 707-001	1	Light unit
6EB 005 633-001	10	Switches
9XD 130 261-001	5	Bracket for four-point fixing
		H3 bulb,
8GH 002 090-271	1	12V35W
8GH 002 090-133	1	12V55W
8GH 002 090-251	1	24V70W

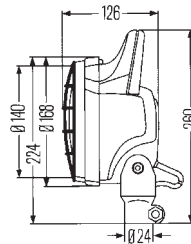
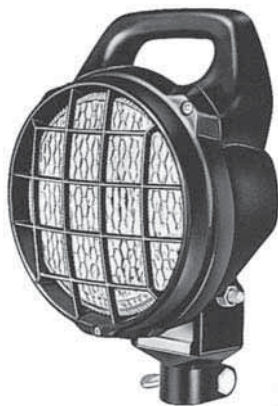

1G4 003 470-141	1	H3 work light with protective grill, spigot mount and 24V70W bulb, without switch. Electrical contacts inside tubular mount over socket (DIN 72 591)
1G4 003 470-147	24	
Spare parts:		
9DS 121 707-001	1	Light unit
8GH 002 090-251	1	H3 bulb, 24V70W

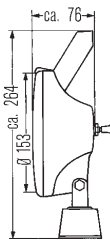
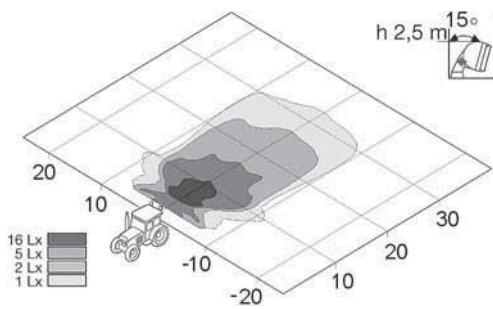

External-fitting work lights for upright or pendant mounting

Torro II

Lens pattern for close-range illumination.
With grommet. Light aperture: 133 mm dia.
 Recommended angle of inclination: 15° - 30°.
 Lens with steel reflector bonded.
 Black plastic body and handle.
 With pivot base, without vibration damping.
 Pivot range vertical 130°. Type of protection: IP5K4K.

Part no.	Pk.	
1G4 004 480-001	1	H3 work light with bracket for four-point mounting and splash-proof switch
9XD 130 261-001	5	Spare parts/Accessories: Bracket for four-point fixing
8GH 002 090-271	1	H3 bulb, 12V35W
8GH 002 090-133	1	12V55W
8GH 002 090-251	1	24V70W

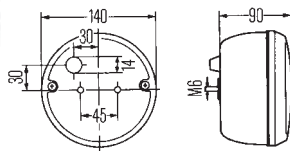
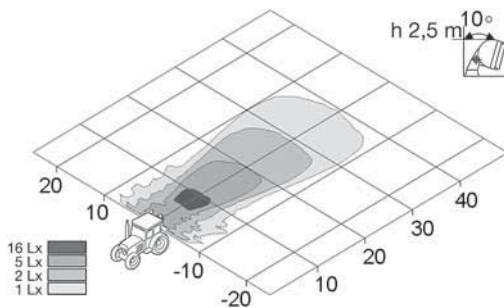

External-fitting work lights

7033

Lens pattern for close-range illumination.
Light aperture: 140 mm dia.
 Recommended angle of inclination: 10° - 30°.
 Black plastic body.
 Two M6 fixing screws.

Part no.	Pk.	
1G4 997 033-011	1	H3 work light
8GH 002 090-271	1	Accessories: H3 bulb, 12V35W
8GH 002 090-133	1	12V55W

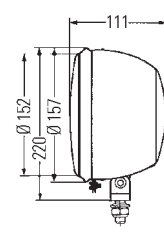
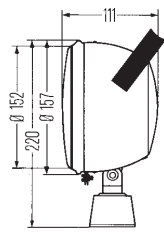
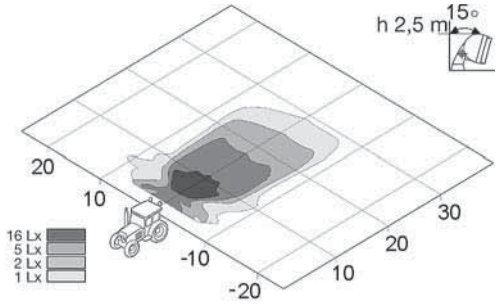

External-fitting work lights for upright or pendant mounting

Lens pattern for close-range illumination.
With grommet. Light aperture: 152 mm dia.
 Recommended angle of inclination: 20° - 25°.
 Steel body with matt black finish.
 Steel reflector with glass lens bonded.
 Rubber boot prevents lateral scattered light.
 With pivot base, without vibration damping.
 Pivot range vertical 130°. Type of protection: IP5K4K.

Part no.	Pk.	
1G5 003 241-081	1	H3 work light with bracket for four-point mounting, handle and splash-proof switch
Spare parts/Accessories:		
1G5 120 510-001	1	Light unit with seal
9GD 120 670-001	10	Gasket
6ED 708 919-001	5	Switches
8GH 002 090-271	1	H3 bulb, 12V35W
8GH 002 090-133	1	12V55W
8GH 002 090-251	1	24V70W
1G5 003 241-071	1	H3 work light with M10 fixing screw, without handle and switch
Spare parts/Accessories:		
1G5 120 510-001	1	Light unit with seal
9GD 120 670-001	10	Gasket
8GH 002 090-271	1	H3 bulb, 12V35W
8GH 002 090-133	1	12V55W
8GH 002 090-251	1	24V70W

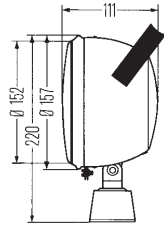
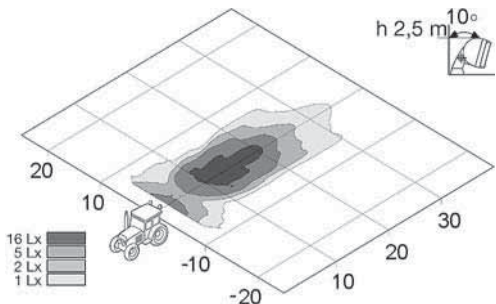

Lens pattern for long-range illumination.
With grommet. Light aperture: 152 mm dia.
 Recommended angle of inclination: 15° - 20°.
 Steel body with matt black finish.
 Steel reflector with glass lens bonded.
 Rubber boot prevents lateral scattered light.
 With pivot base, without vibration damping.
 Pivot range vertical 130°. Type of protection: IP5K4K.

Part no.	Pk.	
1G5 003 241-021	1	H3 work light with bracket for four-point mounting, handle and splash-proof switch
Spare parts/Accessories:		
1G5 119 738-001	1	Light unit with seal
9GD 120 670-001	10	Gasket
6ED 708 919-001	5	Switches
8GH 002 090-271	1	H3 bulb, 12V35W
8GH 002 090-133	1	12V55W
8GH 002 090-251	1	24V70W

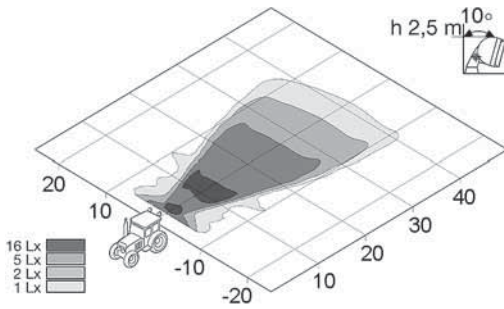

External-fitting work lights for upright or pendant mounting

Lens pattern for long-range illumination. With grommet. Light aperture: 180 mm dia.
 Recommended angle of inclination: 10° - 20°.
 Steel body with matt black finish.
 Steel reflector with glass lens bonded.
 Rubber boot prevents lateral scattered light.
 With pivot base, without vibration damping.
 Pivot range vertical 130°. Type of protection: IP5K4K.

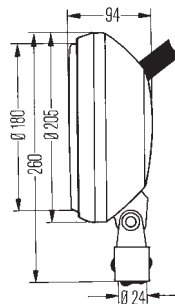
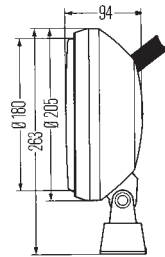

Part no.	Pk.	
1G8 002 340-001	1	H3 work light with bracket for four-point mounting
1G8 002 340-011	1	H3 work light with 2500 mm rubber tube, 2-pole low voltage plug 8JA 001 925-001 (Pk.2) and mounting clamp for mounting on 24 mm dia. standard pin, as well as on 30 mm dia. standard pin after removing reducing sleeve from pipe fitting
1G8 132 233-011	1	Spare parts/Accessories: Light unit with lens-retaining rim
8GH 002 090-271	1	H3 bulb,
8GH 002 090-133	1	12V35W
8GH 002 090-251	1	12V55W
	1	24V70W

Work lights for upright mounting

HypaLUME

With 56 LEDs 240W and 1800 mm long lead with 2-pole DEUTSCH plug connector.
Light aperture: 396 x 67 mm.

Recommended angle of inclination: 3° - 10°.
Reflector made of plastic, glued to hardened plastic lens.
Black body made of diecast aluminium.
Rear of body made of yellow plastic.
With heavy Duty bracket and polarity reversal protection.
Voltage range: 18V - 52V. Type of protection: IP6K9K.

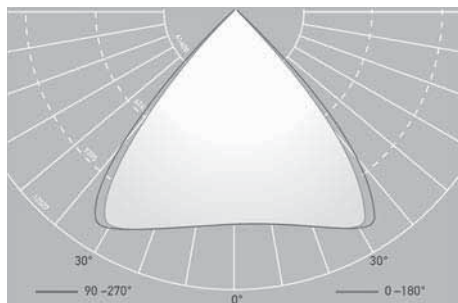
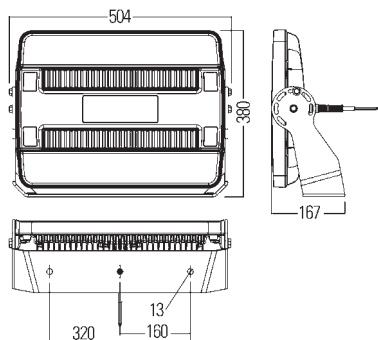

1GJ 011 872-011

1

LED work light, 20.000 lm,
lens pattern for extra-wide illumination

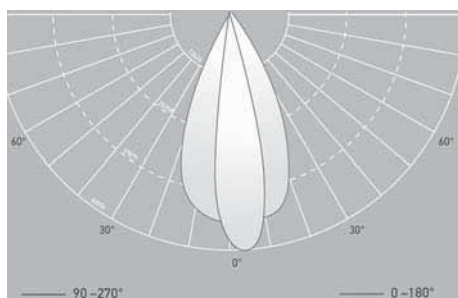

1GJ 011 872-021

1

with lens pattern for close-range illumination

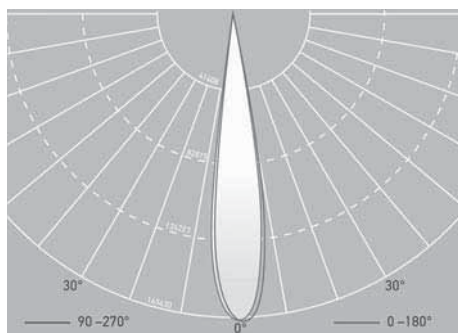

1GJ 011 872-031

1

with lens pattern for long-range illumination

External-fitting work lights

AS 200 Xenon

Lens pattern for long-range illumination.

With gas discharge bulb. Light aperture: 123 x 123 mm.

Recommended angle of inclination: 3° - 10°.

Plastic reflector with glass lens bonded.

Black plastic body with extending edge to protect lens.

With red decorative ring. Handle recessed into body.

Xenon electronic unit 24V42W integrated into body.

Switch with integrated fuse 15A.

With 2500 mm rubber tube and 2-pole low voltage plug 8JA 001 925-001.

Easy-to-loosen pipe fitting mount 24 mm dia.,

fits 30 mm dia. attachment pin in combination

with joint 9XS 027 639-001.

Can be used with tripod 8XT 002 117-001 and

8XT 002 120-001 as well as socket 8XT 002 121-001.

Type of protection: IP5K4K and IPX9K.

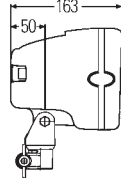
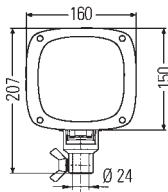
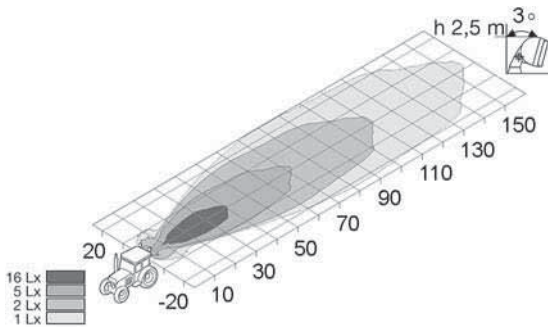

Part no.	Pk.	
1GA 996 142-221	1	Xenon work light
Spare parts/Accessories:		
		Light unit
		(D1S) 7/2011->
1GA 990 305-071	1	D1S gas discharge bulb, 35W
8GS 009 028-111	1	Plug, 2-pole
8JA 001 925-001	1	Blade-type fuses, 15A (5 pcs.)
8JS 711 687-821	1	Joint
9XS 027 639-001	1	

Conforms to DIN 14 644.

Light aperture: 250 mm dia.

750 m range with 12V55W,

800 m range with 24V70W.

Flat lens without optical pattern. Steel reflector.

Black finish steel body and lens retaining rim.

Two side handles, built-in switch.

2500 mm long lead with low voltage plug 8JA 001 925-001 (Pk. 2).

Easy-to-loosen pipe fitting mount 24 mm dia., fits 30 mm dia. attachment pin

in combination with joint 9XS 027 639-001.

Can be used with tripod 8XT 002 117-001 and 8XT 002 120-001

as well as socket 8XT 002 121-001.

Type of protection: IP5K4K.

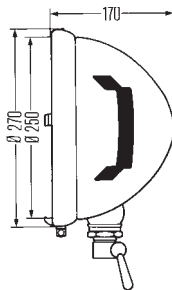

Part no.	Pk.	
1G9 001 523-021	1	H3 work light
Spare parts/Accessories:		
8JA 001 925-001	1	Plug, 2-pole
		H3 bulb,
8GH 002 090-271	1	12V35W
8GH 002 090-133	1	12V55W
8GH 002 090-251	1	24V70W
9XS 027 639-001	1	Joint

Accessories

For work lights

1GA 996 142-221, 1G9 001 523-021, 1G8 002 340-011



Part no.	Pk.	
8XT 002 120-001	1	Extends from 1263 mm to 2200 mm, with 30 mm dia. attachment pin, can be welded onto vehicle or fastened with clights. Tubular steel pipe
8XT 002 117-001	1	Extends from 1051 mm to 1650 mm. 30 mm dia. attachment pin. Tubular steel tripod
8XT 002 121-001	1	For mounting work light on vehicle roof or other horizontal body surface, with 30 mm dia. attachment pin. Socket
9XS 027 639-001	1	With 24 mm dia. attachment pin and 30 mm dia. attachment sleeve. swiveling 180°, with handle, lockable. Joint
8HG 159 455-001	1	With M10 thread. For 30 mm dia. attachment sleeve. Universal holder

Accessories

Mounting bushes 24 mm dia.

for Matador 1G4 003 470-141/-147,
Ultra Beam 1GA 996 150-151, 1GA 007 506-681 and
bracket attachment foot 8HG 990 320-001.
With socket to DIN 72 591 and rubber protective cap.

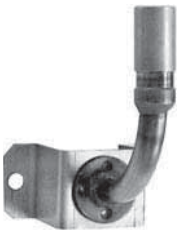

Part no.	Pk.	
8HG 002 365-001	1	Mounting bush for mounting on support side of the vehicle or for welding to a flange, 24 mm dia., approx. 100 mm, with ground contact through the pipe
8HG 006 294-101	1	
8HG 096 531-007	2	Spare parts/Accessories: Mounting bush for -001 Socket for -001 Rubber cap
8JB 850 434-011	10	
9GH 096 532-001	10	
8HG 006 294-051	1	Mounting bush with screw fixing and ground contact through the pipe and separate ground connection
8HG 006 294-091	1	
8HG 006 294-011	1	Mounting bush, for screwing onto horizontal cabin roofs (on top)
8HG 006 294-021	1	Mounting bush for screwing onto horizontal cabin roofs (on side) with 90 mm mounting bracket
8HG 006 294-111	1	
8HG 006 294-131	1	Mounting bush with 90° angle of rotation
8HG 006 294-031	1	Mounting bush for screwing onto horizontal cabin roofs (on top or on side). Swivelling holder
8HG 006 294-041	1	Length: 1000 mm. Extension: up to 700 mm. For screwing onto back of cabin roof. Telescopic holder
8HG 990 368-001	1	Black, with M8 thread. Length: 220 mm. Mounting bush
8HG 990 368-007	25	
8JB 850 434-011	10	Spare parts: Socket Rubber cap
9GH 096 532-001	10	

Accessories

Bracket attachment foot

For combination with attachment tubes
 8HG 002 365-001 and 8HG 006 294-...
 Suitable for external-fitting work lights
 with a bracket width of 42 mm,
 e. g. Ultra Beam, Mega Beam, Power Beam, Oval 100, AS 200.
 Electrical contacting within the pipe socket via
 socket in accordance with DIN 72 591.



Part no.	Pk.	
8HG 990 320-001	1	Bracket attachment foot with 240 mm long lead, grommet and 2-pole AMP plug connector
8HG 990 320-011	1	with 200 mm long lead and 2-pole DEUTSCH plug connector

Universal bracket

E. g. for external-fitting work lights
 Oval 100, Oval Xenon Integral, Picador, AS 200, Ultra Beam,
 Mega Beam, Modul 70

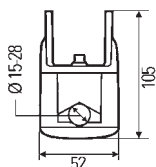

Part no.	Pk.	
8HG 990 263-111	1	Universal bracket for tubular mount on 15 mm - 25 mm dia. pipes, for work lights with a bracket width of 36 mm
8HG 990 263-131	1	for work lights with a bracket width of 42 mm

Accessories

Universal brackets

For external-fitting worklights
 Ultra Beam, Mega Beam, Oval 100, Double Beam, AS 200,
 Power Beam, Modul 90, Q 90, AP 1200



Part no.	Pk.	
9XD 990 298-031	1	For work lights with a bracket width of 42 mm. Angular bracket
8HG 332 912-002	8	Universal plastic bracket
8HG 994 974-002	8	Universal bracket with eyelet
8HG 992 377-042	8	Universal bracket

Universal bracket

E. g. for work lights
 Oval 90, Modul 70, PowerXen, Flat Beam

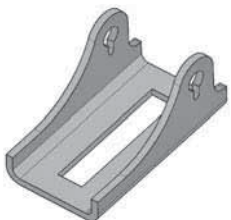
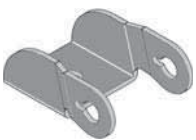

Part no.	Pk.	
8HG 994 412-372	8	For work lights with a bracket width of 36 mm. Fork bracket
8HG 331 414-372	8	Slot bracket

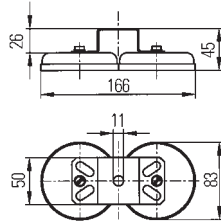
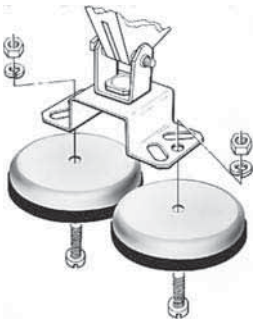

Accessories

Magnet bracket

For work lights with U-bracket or for U-bracket
9XD 130 261-001.
Contents: 2 magnets and fixing material.

Part no.	Pk.	
8HG 004 806-001	1	Magnet bracket

Bracket for four-point fixing

for external-fitting headlights and work lights with M10 fixing screw.

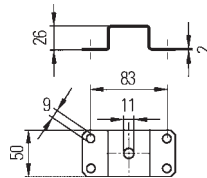
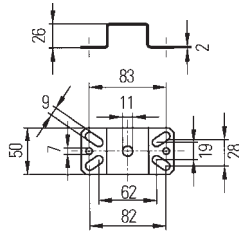

Part no.	Pk.	
9XD 130 261-001	5	Bracket for four-point fixing made of stainless steel
9XD 990 298-001	5	made of yellow chromised steel

Supply unit

For LED work lights with DEUTSCH plug connector.
E. g. Power Beam, Ultra Beam, Oval 90, 100, Modul 50, 90.
Capacity: 60W.
Input: 230V, with 10.000 mm lead and plug.
Output: 24V, with 10.000 mm lead and DEUTSCH plug.
Type of protection: IP67.



Part no.	Pk.	
8EN 332 584-001	1	Supply unit, 230V/24V

Adapter lead

Adapter lead, 200 mm long, with DEUTSCH- and AMP plug connector.
For conversion from halogen worklights with AMP plug connector
on LED work lights with DEUTSCH plug connector.



Part no.	Pk.	
8KB 990 299-361	1	Adapter lead

Hand-held searchlights

Light aperture: 139 mm dia.

Range:

**continuous light 330 m, additional light 350 m,
continuous light with additional light 480 m.**

Black plastic body, lens-retaining rim, handle and supporting base.

Extending lens-retaining rim protects the lens.

Glass lens without optical pattern.

Double reflector made of aluminium.

Two light sources, can be switched via switches which are independent of each other. Flip switch for continuous light and pistol switch in the handle with morse function for additional light.

Handle can be swivelled vertically by 70°.

With closable opening for plugging onto the separate supporting base.

Can be swivelled horizontally by 360° on the supporting base.

Supporting base with 3 fixing screws.

Spiral lead 3500 mm long with universal plug for cigarette lighter sockets or ISO sockets.

Type of protection: IPX6K.

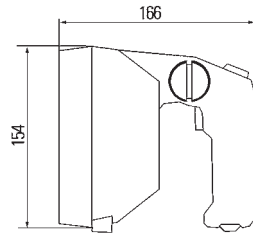

Part no.	Pk.	
1H5 998 502-002	1	H3 hand-held searchlight with 12V55W bulbs
1H5 998 502-067	6	with 24V70W bulbs
Spare parts/Accessories:		
8HG 998 519-002	1	Supporting base with fixing screws
9SG 998 005-002	1	Handle with switch, spirally lead and plug
8JA 001 921-102	12	Connectors
8GH 002 090-133	1	H3 bulb, 12V55W
8GH 002 090-251	1	24V70W

Cabin-controlled searchlights

Light aperture: 139 mm dia.

Range at 12V: 460 m,

range at 24V: 520 m.

Black plastic body, lens-retaining rim, handle and tie rod end.

Guide tube made of stainless steel.

Projecting lens-retaining rim protects the lens.

Glass lens without optical pattern.

Double reflector made of aluminium.

Flip switch in the handle switches both bulbs simultaneously.

The searchlight can be swivelled through 360° in the horizontal range and through 30° in the vertical range.

Mounting area: 72 mm dia.

Connecting lead 330 mm long with grommet led out of the guide tube.

Type of protection: IP5K4K.

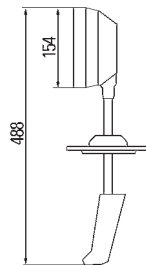

Part no.	Pk.	
1H5 998 502-022	1	H3 cabin-controlled searchlight with 181 mm long guide tube and 12V55W bulbs
1H5 998 502-051	1	with 233 mm long guide tube and 24V70W bulbs
Spare parts:		
8GH 002 090-133	1	H3 bulb, 12V55W
8GH 002 090-251	1	24V70W

Hand-held searchlights

Light aperture: 138 mm dia.

Range: 375 m.

Body and tube bright chrome-plated, reflector bright polished.

With black rubber lens-retaining rim.

With morse function (on/off switch with morse button on handle).

With suspension clip on handle and spirally-coiled lead with universal plug for cigarette-lighter socket.

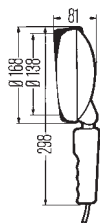

Part no.	Pk.	
1H3 002 456-032	1	H3 hand-held searchlight
		Accessories:
		H3 bulb,
8GH 002 090-133	1	12V55W
8GH 002 090-251	1	24V70W

Cabin-controlled searchlights

Light aperture: 138 mm dia.

Range: 375 m.

Body and tube bright chrome-plated, reflector bright polished.

With black rubber lens-retaining rim.

The searchlight can be turned through 360° horizontally and tilted up to 30° up and down (ball-joint).

It stays in any position.

With morse function (on/off switch with morse button on handle).

With connection lead.

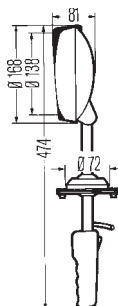

Part no.	Pk.	
1H3 002 456-012	1	H3 cabin-controlled searchlight
		Accessories:
		H3 bulb,
8GH 002 090-133	1	12V55W
8GH 002 090-251	1	24V70W

HELLA VALUEFIT

The HELLA VALUEFIT - proven quality at a good price. Under its HELLA VALUEFIT brand, HELLA offers a specific range of products that are exclusively tailored to the needs of customers in the independent aftermarket: these products offer reliable quality at a fair market price.

Here, HELLA has combined its decades of technological expertise with unparalleled marketing skills. As a result, all these spare parts comply with the relevant technical specifications, are safe and reliable and facilitate more cost-effective repairs.

The products in the HELLA VALUEFIT brand offer genuine added value – be smart: buy proven quality at a good price!



Work lights

1.194

External-fitting work lights for upright mounting

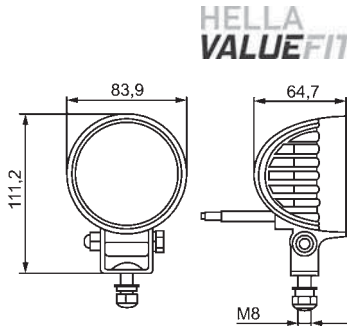

HELLA
VALUEFIT

Lens pattern for wide illumination.
With 4 Power LEDs and 500 mm long lead with stripped ends.
Light aperture: 84 mm dia.

Clear PC lens.
 Black finish aluminium body with cooling ribs.
 Pivot base made of stainless steel with M8 fixing screw.
 With polarity reversal protection.
 Voltage range: 10V - 30V. Type of protection: IP67.

Part no.	Pk.	
1G0 357 000-001	1	LED work light, 12W, 500 lm

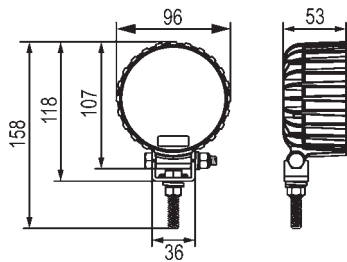

HELLA
VALUEFIT

Lens pattern for wide illumination.
With 4 Power LEDs and 300 mm long lead with stripped ends.
Light aperture: 96 mm dia.

Clear PC lens.
 Black finish aluminium body with cooling ribs.
 Pivot base made of stainless steel with M8 fixing screw.
 With polarity reversal protection.
 Voltage range: 10V - 80V. Type of protection: IP67.

Part no.	Pk.	
1G0 357 002-001	1	LED work light, 16W, 800 lm

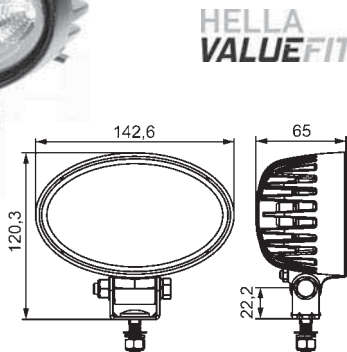

HELLA
VALUEFIT

Lens pattern for wide illumination.
With 8 Power LEDs and 500 mm long lead with stripped ends.

Clear PC lens.
 Black finish aluminium body with cooling ribs.
 Pivot base made of stainless steel with M8 fixing screw.
 With polarity reversal protection.
 Voltage range: 10V - 30V. Type of protection: IP67.















Part no.	Pk.	
1GA 357 001-001	1	LED work light, 24W, 1050 lm



































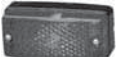

Contents lights series	2.02-2.04
Instructions for LED lights	2.05-2.07
Signal lights	2.08-2.64
Side-marker lights	2.161-2.164
Rear-, clearance- and position lights	2.165-2.168
Position lights	2.169-2.170
Daytime running lights	2.171-2.179
Licence plate lights	2.180-2.186
Clearance lights	2.187-2.191
Track-control lights	2.192
Rear fog lights	2.193-2.196
Reverse lights	2.193-2.201
Safety brake lights	2.202-2.206
Indicator lights	2.207-2.213
Indicator lights for two-wheeled vehicles	2.213
Auxiliary indicators	2.214-2.217
Indicator-position lights	2.218-2.219
Interior lights	2.220-2.243
Reading lights	2.244-2.246
Handlights	2.246
Door lights	2.247-2.249
Warning lights	2.250-2.251
Hazard flasher lights	2.252-2.253
Emergency triangle	2.254
Reflectors	2.255-2.260

Signal lights and cabling	2.261-2.338
----------------------------------	--------------------

HELLA VALUEFIT Signal lights	2.339-2.362
---	--------------------

		343 640 series	2.29-2.31
		006 040 series	2.32-2.34
		007 547 series	2.35
		998 232 series	2.47-2.50
		998 233 series	2.51
		959 037 - 980 710 series	2.65-2.67
		002 582 series	2.67
		003 184 series	2.68
		997 131 series	2.69
		997 006 series	2.70
		003 182 series	2.71
		002 776 series	2.72
		003 185 series	2.73
		003 018 series	2.73

	008 405 / 011 172 / 008 221 series	2.74-2.78
	009 362 / 009 001 series	2.79-2.85
	965 039 series	2.86-2.87
	302 252 series	2.88
	001 423 series	2.89
	959 010 / 959 011 / 980 690 series	2.90-2.91
	344 200 series	2.92-2.94
	964 169 / 344 169 series	2.95-2.102
	959 820 - 959 950 series	2.103
	001 240 series	2.104
	343 390 / 343 130 series	2.105-2.112
	001 259 series	2.113-2.115
	003 057 - 005 639 series	2.116-2.117
	003 014 series	2.118-2.119
	996 012 series	2.120
	013 236 / 003 236 / 005 200 series	2.121-2.128

		004 431 / 004 432 series	2.129-2.130
		Serie 008 982 / 008 805	2.130-2.132
		005 603 / 004 119 series	2.133-2.134
		003 734 series	2.135-2.136
		962 964 series	2.137
		006 717 series	2.138
		997 027 series	2.139
		Serie 980 880 - 980 889	2.140-2.141
		003 748 series	2.142
		963 959 series	2.143
		004 361 series	2.144
		345 600 series	2.145-2.146
		340 000 series	2.147
		008 645 / 011 422 series	2.148-2.150
		344 690 series	2.151-2.152
		964 295 series	2.153-2.155
		959 510 - 980 855 series	2.155-2.157
		009 226 series	2.158
		003 389 series	2.159-2.160



Instruction 1 - Regarding LED technology multi-function lights

In connection with these low powers, which are very different from bulb versions, there can be problems with the bulb failure check during operation on various traction vehicles.

Since indicator failure checks are required by legislation, we recommend only operating the light in combination with an indicator control unit part no. "5DS 009 602-..., 5DS 009 552-... or LED flasher unit 4.. 009 492".

In addition, further lighting functions are detected by some traction vehicles. This is a vehicle comfort function which is not required by legislation and does not release drivers from their obligation to see for themselves that the lighting equipment is working.

Here, too, faulty diagnoses can be a result of the lower power levels involved (instrument panel in the driver cab indicates a bulb failure although the function is working).

Operation of the light with alternating current or pulsed direct current is not permitted!

The functional ability of these light failure checks can only be established by the vehicle manufacturer.

The individual light functions may only be operated with a vehicle fuse of max. 3A.

In the case of onboard current limitation with the values specified above by the onboard control unit an additional fuse for the lamp is not required.

Instruction 2 - Regarding single or double function lights with LEDs without flasher function

In connection with these low powers, which are very different from bulb versions, there can be problems during operation on various traction vehicles because further lighting functions are detected by some traction vehicles.

This is a vehicle comfort function which is not required by legislation and does not release drivers from their obligation to see for themselves that the lighting equipment is working.

Here, too, faulty diagnoses can be a result of the lower power levels involved (instrument panel in the driver cab indicates a bulb failure although the function is working).

The functional ability of these light failure checks can only be established by the vehicle manufacturer.

Operation of the light with alternating current or pulsed direct current is not permitted!

The individual light functions may only be operated with a vehicle fuse of max. 3A.

In the case of onboard current limitation with the values specified above by the onboard control unit an additional fuse for the lamp is not required.

Instruction 3 - Regarding flasher lights with LEDs with active electronics

In connection with these low powers, which are very different from bulb versions, there can be problems with the bulb failure check during operation on various traction vehicles.

Since indicator failure checks are required by legislation, we recommend only operating the light in combination with an indicator control unit part no. "5DS 009 602-..., 5DS 009 552-... or LED flasher unit 4.. 009 492".

Operation of the light with alternating current or pulsed direct current is not permitted!

The individual light functions may only be operated with a vehicle fuse of max. 3A.

Instruction 4 - Regarding flasher lights with LEDs with passive electronics

In connection with these low powers, which differ significantly from those of a bulb-based version, problems arise with the indicator failure check during operation on various traction vehicles.

The indicator failure check required by legislation in the area of validity of the ECE R48 regulation must be guaranteed by suitable measures within the vehicle. The customer is responsible for this.

In addition, further lighting functions are detected by some traction vehicles.

This is a vehicle comfort function which is not required by legislation and does not release drivers from their obligation to see for themselves that the lighting equipment is working.

Here, too, faulty diagnosis can occur on account of the low power levels involved (instrument panel in the driver cab indicates light failure although the function is working).

Operation of the light with AC voltage or synchronised DC voltage is not permitted.

The individual light functions may only be operated with a vehicle fuse of max. 3A.

Legal requirement in all ECE states

In the case of vehicles approved for use on public roads, the indicators must be monitored: The failure of an indicator must be shown optically or acoustically in the vehicle. This applies in all ECE states. In other words, the potential failure of the indicator must be monitored by the vehicle. Manufacturers use various failure control systems. The failure control systems currently in use cannot detect simple LED lights and displays a fault.

All HELLA LED indicators have integrated electronics for failure control.

The indicators are selfmonitoring.

They generate a pulse that is evaluated by the electronic ballast.

The ballast simulates a 21W bulb, which makes operation with conventional flasher units possible.

As soon as one single LED fails, the light can be considered faulty, the pulse is not generated. The ballast then switches the bulb simulation off and the flasher unit indicates the fault to the driver.

Safe conversion to LED indicators now possible thanks patented HELLA electronics

HELLA supplies electronic ballasts for all HELLA LED indicators which make it possible to convert the indicator failure display for various vehicles. This is necessary if the vehicle manufacturer does not guarantee indicator bulb failure control via the vehicle wiring system. The method has been patented for HELLA. At the moment, there are three different ballasts and several different LED indicator types available.

LED indicator failure control: background information

Why does the failure detection required by law work with various LED lights with some flasher units and not with others?

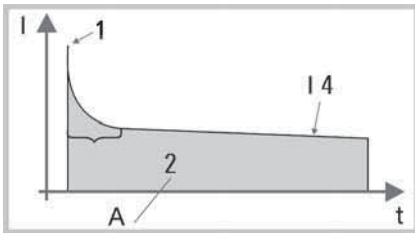

Fig. 1

Fig. 1 illustrates the typical current pattern when a bulb is switched on.

Different flasher units detect this in different ways, for example by

- measuring the pulse peak or
- measuring the current at some point during the switch-on pulse or
- measuring the current after the pulse, when the current is constant and has a certain intensity, or
- determining the total energy flowing through the light (size of area A)

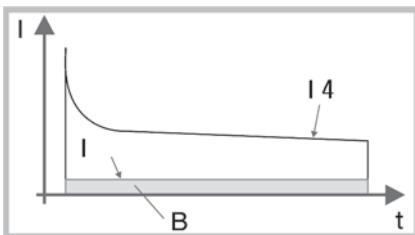

Fig. 2

Fig. 2 shows the LED current (I_{LED}) in relation to this. None of the methods mentioned above can work here, because there is neither a switch-on pulse available nor is the current intensity high enough or the total energy through both lights is identical (area B is as large as A).

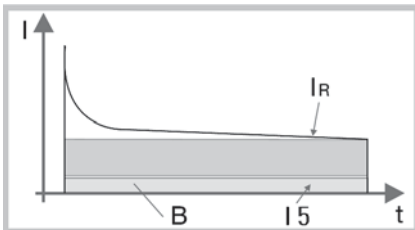

Fig. 3

If a simple Ohmic resistor is inserted, e.g. a resistor cable, the current is increased by a certain value (I_R) and the curve illustrated in Fig. 3 is the result.

In this case, only a flasher unit according to principle c) would work.

If the resistance is chosen somewhat higher, principle d) could also possibly work.

If the light fails afterwards due to mechanical damage, the flasher unit could detect the insert resistor as a functional bulb. In this case, a light working perfectly would be indicated although this is not the case!

This means: In this case the vehicle would lose this approval for use on public roads.

The only solution conceivable for universal use is one that works with all the flasher units on the market. As the above considerations have shown, this can practically only be guaranteed if the current pattern of a bulb is simulated exactly by means of an electronic circuit.

Since such a circuit is extremely complex, it is not possible to integrate this in the LED light. In order to be able to benefit from the advantages of LED lights despite this fact, a ballast is required to the circuit. This combination provides the perfect - and above all legally conform - solution to the problem.

- I = Current
- t = Time
- 1 = Pulse peak
- 2 = Switch-on pulse
- 3 = Individual pulse
- 4 = Bulb
- 5 = LED

HELLA patent for the perfect problem solution

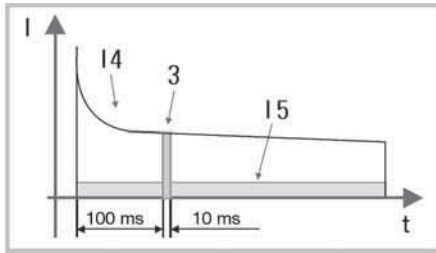

Fig. 4

I = Current
t = Time
1 = Pulse peak
2 = Switch-on pulse
3 = Individual pulse
4 = Bulb
5 = LED

All HELLA LED indicators with integrated electronics for failure control are self-monitoring and generate an individual pulse. This pulse is evaluated by the electronic ballasts. The ballasts simulate a 21W bulb.

This makes operation with conventional flasher units possible. If the light is faulty, which can be the case if only a single LED fails, the above-mentioned pulse is not generated. The ballasts then switch the bulb simulation off and the flasher unit indicates the LED fault to the driver.

By measuring the light current during a time window of 10 ms (Fig. 4), direct exchange between the HELLA LED light and a bulb version is possible.

HELLA ballasts are straightforward to convert even at a later date.

Vehicle manufacturers can also ensure ECE-conform failure control by evaluating the pulse of the HELLA LED indicators shown in the adjacent diagram directly in their control units. The exact specification can be obtained from HELLA.

Which HELLA ballast for which vehicle?



1. Vehicles that use the cold scan for indicator failure control.

Description of fault indication:

Is a faulty light indicated when the ignition is switched on or directly when the fault occurs, or when the bulb is screwed out without the indicator being triggered?

Solution: Simulation device for cold scan

Part no.	Pk.	
		Simulation device for cold scan,
5DS 009 602-011	1	12V
5DS 009 602-001	1	24V



2. Vehicles without flasher unit that carry out current measurement as failure control.

Description of fault indication:

Is a fault only determined during flashing (e.g. double flashing frequency)?

Solution: Indicator control unit

5DS 009 552-001	1	Indicator control unit for trucks and trailers, 24V, with one 15-pole EasyConn plug and one 15-pole Easy-Conn socket
5DS 009 552-011	1	lead end with blade terminal contact 6.3 mm

No separate power supply necessary.
Type of protection: IP6K9K.



3. Vehicles with flasher unit

Solution: Replacement of the existing flasher unit by an LED flasher unit

4DN 009 492-101	1	LED flasher unit, 12V 2+1+1
4DW 009 492-111	1	LED flasher unit, 12V 3+1
4DM 009 492-001	1	LED flasher unit, 24V 2+1
4DW 009 492-011	1	LED flasher unit, 24V 3+1

For horizontal surface mounting on towing vehicles

Red rear, stop, rear fog, clearance light and reflector, amber indicator and side-marker light, white reverse light.

Two M8 fixing screws.

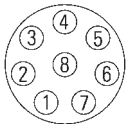

1	indicator	amber
2	rear/licence plate/clearance/side-marker	brown
3	stop	red
4	rear fog	blue
5	reverse	black
6	-	not used
7	-	not used
8	ground	white

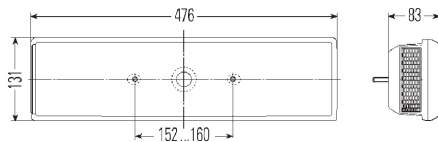

Part no.	Pk.	
2VP 007 323-011	1	Rear-reflector-stop-indicator-rear fog-reverse-clearance-side-marker light with grommet, left
2VP 007 323-021	1	right
2VP 007 323-111	1	Rear-reflector-stop-indicator-rear fog-reverse-clearance-side-marker light with 8-pole, black central plug and 24V bulbs, left
2VP 007 323-121	1	right
2VD 007 323-031	1	Rear-reflector-stop-indicator-rear fog-reverse-clearance light and side-marker light with reflector, with illumination for 520 x 120 mm and 340 x 240 mm licence plates, with grommet, left
2VD 007 323-041	1	right
2VD 007 323-131	1	Rear-reflector-stop-indicator-rear fog-reverse-clearance light and side-marker light with reflector, with illumination for 520 x 120 mm and 340 x 240 mm licence plates, with 8-pole, black central plug and 24V bulbs, left
2VD 007 323-141	1	right
9EL 146 887-001	1	Spare parts/Accessories: Lens
9EL 146 838-001	2	Side-marker light with reflector R5W bulb,
8GA 002 071-121	10	12V
8GA 002 071-241	10	24V R10W bulb,
8GA 002 071-131	10	12V
8GA 002 071-251	10	24V P21W bulb,
8GA 002 073-121	10	12V
8GA 002 073-241	10	24V

For horizontal or vertical flush mounting in towing vehicles and mobile homes



Red rear, stop, rear fog, clearance light and reflector, amber indicator light, white reverse light.
With grommet.
Two M8 fixing screws.

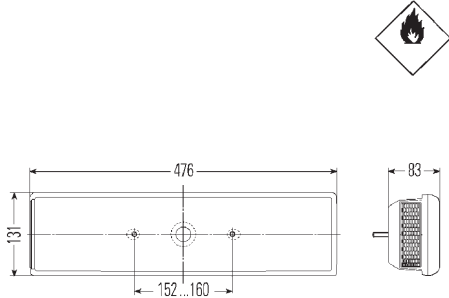

Part no.	Pk.	
2VP 007 323-091	1	Rear-reflector-stop-indicator-rear fog-reverse-clearance light, left
2VP 007 323-101	1	right
Spare parts/Accessories:		
9EL 146 887-001	1	Lens
8GA 002 071-121	10	R5W bulb, 12V
8GA 002 071-241	10	R10W bulb, 24V
8GA 002 071-131	10	12V
8GA 002 071-251	10	24V
8GA 002 073-121	10	P21W bulb, 12V
8GA 002 073-241	10	P21W bulb, 24V

For horizontal surface mounting on towing vehicles

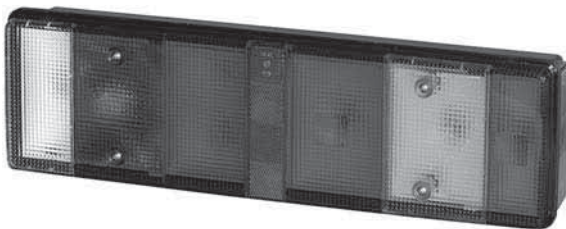

Red rear, stop, rear fog, clearance light and reflector, amber indicator and side-marker light with reflector, white reverse light, illumination for 520 x 120 mm licence plates.
Black plastic body.
Two M8 fixing screws.



1	ground	white
2	rear/licence plate/clearance/side-marker	brown
3	reverse	amber
4	indicator	green
5	stop	red
6	rear fog	blue
7	-	not used

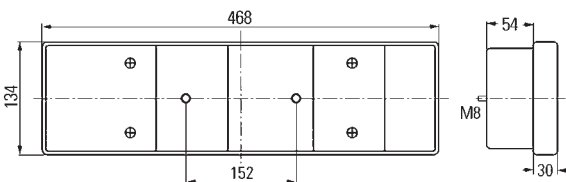

Part no.	Pk.	
2VD 008 204-231	1	Rear-reflector-stop-indicator-rear fog-reverse-clearance light and 7-pole, side-mounted AMP plug connector for RVI vehicles, with licence plate illumination, left
2VP 008 204-221	1	without licence plate illumination, right
2VD 008 204-211	1	Rear-reflector-stop-indicator-rear fog-reverse-clearance light without plug, however with PG fitting, and lead input, with licence plate illumination, left
2VP 008 204-201	1	without licence plate illumination, right
2VD 008 204-251	1	Rear-reflector-stop-indicator-rear fog-reverse-clearance light with 7-pole, side-mounted AMP plug connector for DAF and MAN vehicles, with licence plate illumination, left
2VP 008 204-241	1	without licence plate illumination, right
Spare parts/Accessories:		
9EL 152 889-001	1	Lens with screws
8GA 002 071-121	10	R5W bulb, 12V
8GA 002 071-241	10	R10W bulb, 24V
8GA 002 071-131	10	12V
8GA 002 071-251	10	24V
8GA 002 073-121	10	P21W bulb, 12V
8GA 002 073-241	10	P21W bulb, 24V

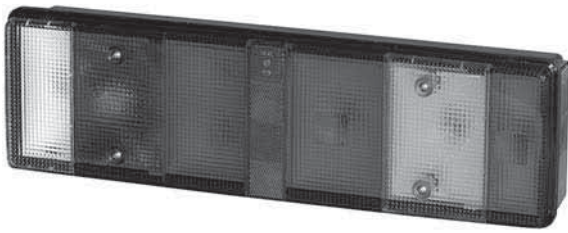

For horizontal surface mounting on towing vehicles

Red rear, stop, rear fog, clearance light and reflector, amber indicator light, white reverse light, illumination for 520 x 120 mm licence plates.
Black plastic body.
Two M8 fixing screws.

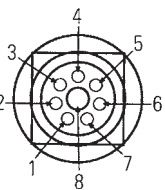
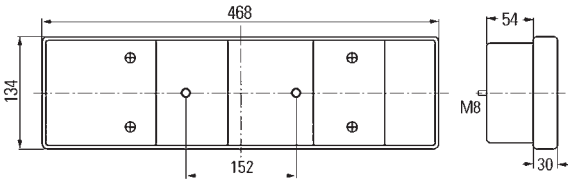

1	indicator	amber
2	rear/licence plate/clearance/side-marker	black
3	stop	red
4	rear fog	blue
5	reverse	grey
6	-	not used
7	-	not used
8	ground	white

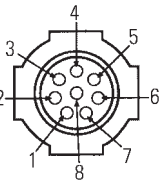

1	clearance/side-marker	green
2	indicator	amber
3	stop	red
4	reverse	black
5	-	not used
6	-	not used
7	-	not used
8	ground	white
9	rear fog	blue
10	rear	brown



Part no.	Pk.	
2VD 008 204-051	1	Rear-reflector-stop-indicator-rear fog-reverse-clearance light with 8-pole AMP plug connector for MAN and Scania vehicles, with licence plate illumination, left and right
2VP 008 204-041	1	without licence plate illumination, left and right
2VD 008 204-071	1	with licence plate illumination, left
2VP 008 204-061	1	without licence plate illumination, left and right
2VD 008 204-131	1	Rear-reflector-stop-indicator-rear fog-reverse-clearance light with rear fog light and licence plate illumination, left
2VP 008 204-121	1	without rear fog light and licence plate illumination, left and right
2VD 008 204-141	1	Rear-reflector-stop-indicator-rear fog-reverse-clearance light with Scania lead input, right
2VD 008 204-171	1	Rear-reflector-stop-indicator-rear fog-reverse-clearance light with 8-pole special plug connector for DAF vehicles, with licence plate illumination, left
2VP 008 204-161	1	without licence plate illumination, left and right
2VD 008 204-191	1	Rear-reflector-stop-indicator-rear fog-reverse-clearance light with 10-pole AMP-plug connector for Iveco-vehicles, with licence plate illumination, left
2VP 008 204-181	1	without licence plate illumination, right
9EL 152 889-001	1	Spare parts/Accessories: Lens with screws
8GA 002 071-121	10	R5W bulb, 12V
8GA 002 071-241	10	24V
8GA 002 073-121	10	P21W bulb, 12V
8GA 002 073-241	10	24V

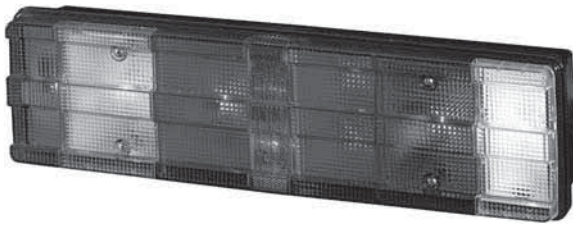

For horizontal surface mounting on towing vehicles

Red rear, stop, rear fog, clearance light and reflector, amber indicator and side-marker light with reflector, white reverse light, illumination for 520 x 120 mm licence plates. Lead entry through central body opening, without grommet. Black plastic body. Two M8 fixing screws.

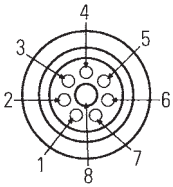
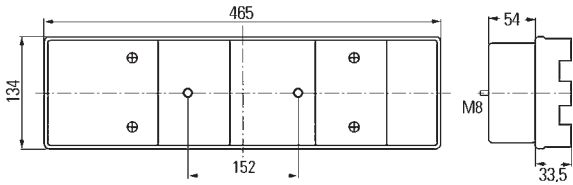

1	indicator	amber
2	rear/licence plate/clearance/side-marker	black/green-red/brown
3	stop	red
4	rear fog	blue
5	reverse	grey
6	-	not used
7	-	not used
8	ground	white

Part no.	Pk.	
2VD 008 204-111	1	Rear-reflector-stop-indicator-rear fog-reverse-clearance-side-marker light with reflector, for Mercedes-Benz vehicles, with rear fog light and licence plate illumination, left
2VP 008 204-101	1	without rear fog light and licence plate illumination, right
2VD 008 204-091	1	Rear-reflector-stop-indicator-rear fog-reverse-clearance-side-marker light with reflector, with 8-pole central plug connector for Mercedes-Benz vehicles, with licence plate illumination, left
2VP 008 204-081	1	without licence plate illumination, right
9EL 152 891-001	1	Spare parts/Accessories: Lens with screws R5W bulb,
8GA 002 071-121	10	12V
8GA 002 071-241	10	24V
8GA 002 073-121	10	P21W bulb, 12V
8GA 002 073-241	10	24V



For horizontal surface mounting on towing vehicles

Red rear, stop, rear fog, clearance light and reflector, amber indicator and side-marker light with reflector, white reverse light, illumination for 520 x 120 mm licence plates.

Black plastic body.
Two M8 fixing screws.

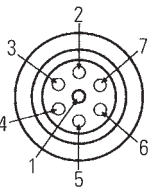

1	ground	white
2	indicator	green
3	stop	red
4	rear/licence plate/clearance/side-marker	brown
5	reverse	amber
6	rear fog	blue
7	-	not used

1	ground	white
2	indicator	green
3	stop	red
4	rear/licence plate/clearance/side-marker	brown
5	reverse	amber
6	rear fog	blue
7	-	not used

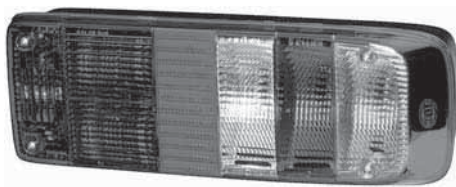
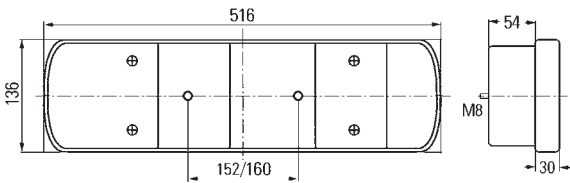

Red rear, reflector, stop and rear fog light, amber indicator- and side-marker light with reflector, reverse light white.

With 4 vibration dampers, 8-pole Schlemmer plug connector and 24V bulbs.

Two bulbs for rear light.

Black plastic body.
Two M8 fixing screws.

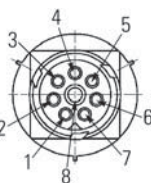
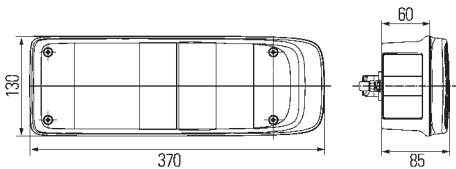

1	indicator	yellow/green
2	rear	brown
3	stop	red
4	rear fog	blue
5	reverse	pink
6	-	not used
7	-	not used
8	ground	white

Part no.	Pk.	
2VD 008 205-011	1	Rear-reflector-stop-indicator-rear fog-reverse-clearance light, with side-marker light and reflector, distance between screws 152 mm, left
2VD 008 205-021	1	right
2VD 008 205-051	1	Rear-reflector-stop-indicator-rear fog-reverse-clearance light, with side-marker light and reflector, with 7-pole, side-mounted AMP-plug connector, distance between screws 160 mm, left
2VD 008 205-041	1	right
2VP 008 205-031	1	Rear-reflector-stop-indicator-rear fog-reverse-clearance light, with side-marker light and reflector, distance between screws 160 mm, with 7-pole, side-mounted AMP-plug connector, left and right
9EL 152 884-001	1	Spare parts/Accessories: Lens with screws
8GA 002 071-121	10	R5W bulb, 12V
8GA 002 071-241	10	24V
8GA 002 071-131	10	R10W bulb, 12V
8GA 002 071-251	10	24V
8GA 002 073-121	10	P21W bulb, 12V
8GA 002 073-241	10	24V

Part no.	Pk.	
2VP 340 888-011	1	Rear-reflector-stop-indicator-rear fog-reverse light and side-marker light with reflector, left
2VP 340 888-017	12	
2VP 340 888-001	1	right
2VP 340 888-007	12	
9EL 340 829-041	1	Spare parts: Lens with screws
8GA 002 071-251	10	R10W bulb, 24V
8GA 002 073-241	10	P21W bulb, 24V
8GP 002 067-241	10	T4W bulb, 24V

For horizontal surface mounting on towing vehicles

Rear light, reflector, stop light, rear fog light, clearance light and side-marker light with reflector red, indicator light (with amber bulb), reverse light and licence plate light white.
With 8-pole HDSCS-plug and DIN-plug.

Black plastic body.
Two M8 fixing screws.

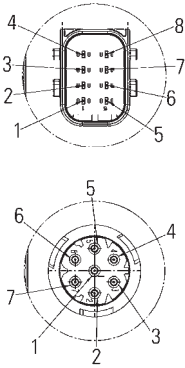
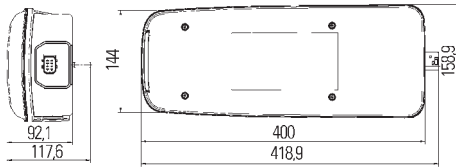

1	ground
2	-
3	-
4	rear fog
5	rear
6	reverse
7	indicator
8	stop
HDSCS plug	
1	ground
2	rear
3	reverse
4	indicator
5	stop
6	rear fog
7	-
DIN plug	

Part no.	Pk.	
2VD 011 511-031	1	Rear-reflector-stop-indicator-rear fog reverse-clearance-side-marker light with reflector with licence plate illumination and 24V bulbs, left
2VP 011 511-041	1	without licence plate illumination, with 24V bulbs, right
2VP 011 511-081	1	without licence plate illumination, with 24V bulbs and backup alarm, right
9EL 194 229-001	1	Spare parts/Accessories: Lens with screws
9DW 194 222-801	1	LED module for retrofitting the bulb version to a hybrid version
8GA 002 071-251	10	R10W bulb, 24V
8GA 002 073-241	10	P21W bulb, 24V
8GA 006 841-241	10	PY21W bulb, 24V
2VD 011 511-231	1	with licence plate illumination, 24V bulbs and 24V LEDs, left
2VP 011 511-241	1	without licence plate illumination, with 24V bulbs and 24V LEDs, right
2VP 011 511-281	1	without licence plate illumination, with 24V bulbs, 24V LEDs and backup alarm, right
9EL 194 229-001	1	Spare parts: Lens with screws
8GA 002 073-241	10	P21W bulb, 24V
8GA 006 841-241	10	PY21W bulb, 24V

For horizontal surface mounting

Truck Full LED

In LED-technology, 24V. With Glowing-Body-technology.

Rear light with 12 red LEDs 2.8W,
 stop light with 18 red LEDs 2.2W,
 indicator light with 6 amber LEDs 4.2W,
 rear fog light with 8 red LEDs 2.5W,
 reverse light with 6 white LEDs 4.7W,
 side-marker light with 5 red LEDs 2.8W,
 licence plate light with 4 white LEDs 1.7W.

With side mounted 7-pole DIN plug.

Black PC/ABS body.

Two M8 fixing screws.

Consumption at 24V:

rear light: 0.12A, stop light: 0.09A, indicator light: 0.18A,

rear fog light: 0.10A, reverse light: 0.20A,

side-marker-/clearance light: 0.12A, licence plate light: 0.07A.

With pulse for indicator failure check.

Type of protection: IP5K4K, IPX9K. See LED instruction 1.

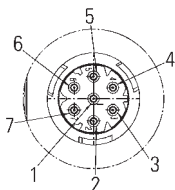
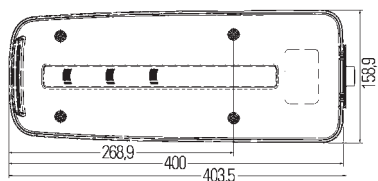
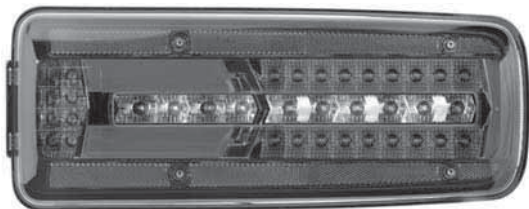

1	ground
2	rear
3	reverse
4	indicator
5	stop
6	rear fog
7	-

Part no.	Pk.	
2VD 012 381-011	1	Rear-reflector-stop-indicator-rear fog-reverse-clearance-side-marker light with reflector with licence plate illumination, left
2VP 012 381-021	1	without licence plate illumination, right
2VD 012 381-031	1	with licence plate illumination and 500 mm long lead, left
2VP 012 381-041	1	without licence plate illumination, with 500 mm long lead, right
2VP 012 381-051	1	Rear-reflector-stop-indicator-rear fog-reverse-clearance-side-marker light with reflector, left
2VP 012 381-061	1	with backup alarm, right
2VP 012 381-081	1	with backup alarm and 500 mm long lead, right
Spare parts/Accessories:		
9EL 208 551-011	1	Lens
5DS 009 602-001	1	LED-Indicator-control unit, 24V
4DW 009 492-011	1	LED flasher unit, 24V

For horizontal surface mounting

Truck Full LED

In LED-technology, 24V. With Glowing-Body-technology.

Rear light with 12 red LEDs 2.8W,
 stop light with 18 red LEDs 2.2W,
 indicator light with 6 amber LEDs 4.2W,
 rear fog light with 8 red LEDs 2.5W,
 reverse light with 4 white LEDs 4.7W,
 side-marker-/clearance light with 5 red LEDs 2.8W,
 licence plate light with 4 white LEDs 1.7W.

With 7-pole DIN plug.

Black PC/ABS body.

Two M8 fixing screws.

Consumption at 24V:

rear light: 0.12A, stop light: 0.09A, indicator light: 0.18A,

rear fog light: 0.10A, reverse light: 0.20A,

side-marker-/clearance light: 0.12A, licence plate light: 0.07A.

With pulse for indicator failure check.

Type of protection: IP5K4K, IPX9K. See LED instruction 1.

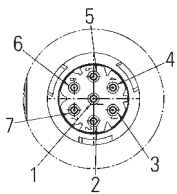
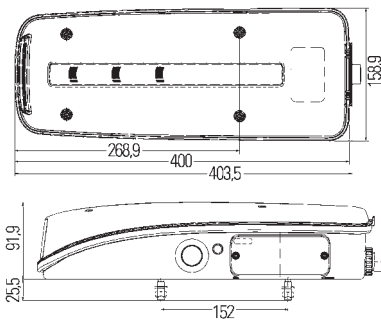
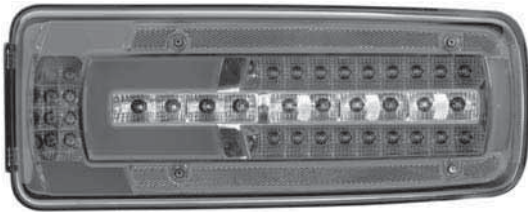

1	ground
2	rear
3	reverse
4	indicator
5	stop
6	rear fog
7	-



Part no.	Pk.	
2VD 012 381-311	1	Rear-reflector-stop-indicator-rear fog-reverse-clearance-side-marker light with reflector with licence plate illumination and side-mounted plug connector, left
2VP 012 381-321	1	without licence plate illumination, with side-mounted plug connector, right
2VP 012 381-341	1	without licence plate illumination, with side-mounted plug connector and backup alarm, right
2VD 012 381-351	1	with licence plate illumination and rear-mounted plug connector, left
2VP 012 381-361	1	without licence plate illumination, with rear-mounted plug connector, right
2VP 012 381-381	1	without licence plate illumination, with rear-mounted plug connector and backup alarm, right
Spare parts/Accessories:		
9EL 208 551-001	1	Lens
5DS 009 602-001	1	LED-Indicator-control unit, 24V
4DW 009 492-011	1	LED flasher unit, 24V

For horizontal surface mounting

Truck Full LED

In LED-technology, 24V. With Glowing-Body-technology.

Rear light with 12 red LEDs 2.8W,
 stop light with 18 red LEDs 2.2W,
 indicator light with 6 amber LEDs 4.2W,
 rear fog light with 8 red LEDs 2.5W,
 reverse light with 4 white LEDs 4.7W,
 side-marker-/clearance light with 5 red LEDs 2.8W,
 licence plate light with 4 white LEDs 1.7W.

With 8-pole HDSCS plug.

Black PC/ABS body.

Two M8 fixing screws.

Consumption at 24V:

rear light: 0.12A, stop light: 0.09A, indicator light: 0.18A,

rear fog light: 0.10A, reverse light: 0.20A,

side-marker-/clearance light: 0.12A, licence plate light: 0.07A.

With pulse for indicator failure check.

Type of protection: IP5K4K, IPX9K. See LED instruction 1.

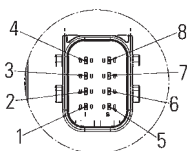
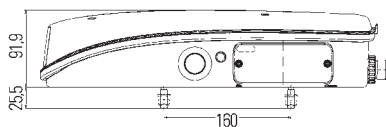
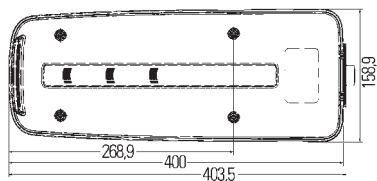

1	ground
2	-
3	-
4	rear fog
5	S
6	reverse
7	indicator
8	stop



Part no.	Pk.	
2VD 012 381-211	1	Rear-reflector-stop-indicator-rear fog-reverse-clearance-side-marker light with reflector with licence plate illumination and side-mounted plug connector, left
2VP 012 381-221	1	without licence plate illumination, with side-mounted plug connector, right
2VP 012 381-241	1	without licence plate illumination, with side-mounted plug connector and backup alarm, right
2VD 012 381-251	1	with licence plate illumination and rear-mounted plug connector, left
2VP 012 381-261	1	without licence plate illumination, with rear-mounted plug connector, right
2VP 012 381-281	1	without licence plate illumination, with rear-mounted plug connector and back alarm, right
Spare parts/Accessories:		
9EL 208 551-001	1	Lens
5DS 009 602-001	1	LED-Indicator-control unit, 24V
4DW 009 492-011	1	LED flasher unit, 24V

For horizontal surface mounting on towing vehicles
Also permissible for trailers in combination
with valid EC component homologation for lighting

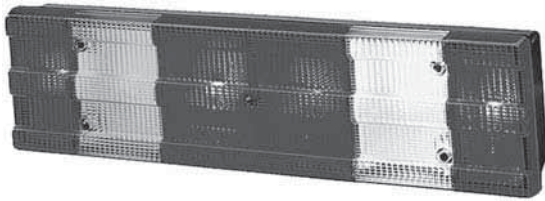

Red rear, stop, rear fog, clearance light and reflector,
amber indicator light, white reverse light,
with illumination for 520 x 120 mm licence plates.
With side mounted amber reflector, vibration dampers
and 24V bulbs.

When used in right-hand traffic, the licence plate window
in the right-hand light must be covered
with the black cover plate 9EL 134 301-011 (Pk. 1),
order separately!

Black plastic body.
Two M8 fixing screws.

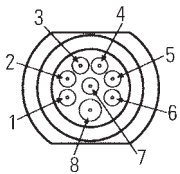

1	indicator	black/white
2	rear/licence plate/ clearance	green/black
3	-	not used
4	rear fog	yellow/black/white
5	reverse	white/red
6	ground	brown
7	stop	black/red
8	-	not used



1	indicator	black/white
2	rear/licence plate/ clearance/side-marker	green/black
3	-	not used
4	rear fog	yellow/black/white
5	reverse	white/red
6	ground	brown
7	stop	black/red
8	-	not used

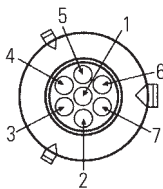

1	ground	brown
2	rear/clearance/ side-marker	green
3	reverse	black
4	indicator	red
5	stop	amber
6	rear fog	white
7	licence plate	green

2VD 007 500-411



1	ground	brown
2	rear/clearance/ side-marker	green
3	reverse	black
4	indicator	red
5	stop	amber
6	-	not used
7	-	not used

2VP 007 500-421/-521

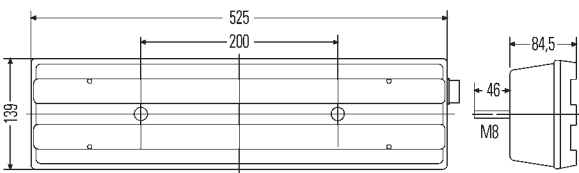

Part no.	Pk.	
2VD 007 500-091	1	Rear-reflector-stop-indicator-rear fog-reverse-clearance-licence plate light with side mounted amber reflector and 1200 mm long lead with 8-pole round plug connector, left
2VD 007 500-201	1	right
2VD 007 500-111	1	Rear-reflector-stop-indicator-rear fog-reverse-clearance-side-marker light with reflector-licence plate light with 1200 mm long lead and 8-pole round plug connector, left
2VD 007 500-221	1	right
2VD 007 500-411	1	Rear-reflector-stop-indicator-reverse-clearance-side-marker light with reflector, with 7-pole, amber centre plug connector and grommets on side, with rear fog light and licence plate light, left
2VP 007 500-421	1	without rear fog light and licence plate illumination, right
2VP 007 500-521	1	Rear-reflector-stop-indicator-rear fog-reverse-clearance-side-marker light with reflector, with backup alarm and electronics for reducing volume at night, right
9EL 134 296-041	1	Spare parts/Accessories: Lens with screws, left
9EL 134 296-051	1	right
9EL 146 838-001	2	Lens for side-marker light for -111/-221/-411/-421
9EL 134 301-001	4	Lens for licence plate illumination, for -091/-111/-201/-221/-411
9GT 074 132-001	10	Grommet for -091/-201/-111/-221
9EL 134 301-011	1	Cover plate, black
8GA 002 071-131	10	R10W bulb, 12V
8GA 002 071-251	10	24V
8GA 002 073-121	10	P21W bulb, 12V
8GA 002 073-241	10	24V

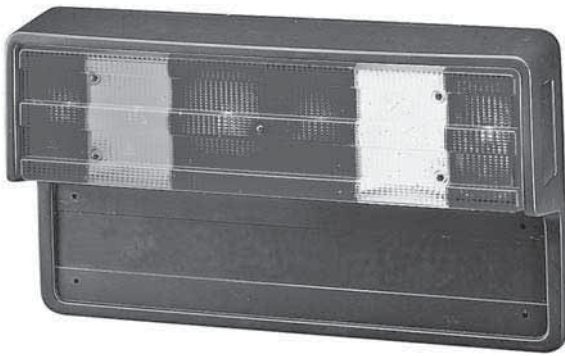

For horizontal surface mounting

Red rear, stop, rear fog, clearance light and reflector, amber indicator light, white reverse light, with illumination for 520 x 120 mm licence plates. With side mounted amber reflector. When used in right-hand traffic, the licence plate window in the right-hand light must be covered with the black cover plate 9EL 134 301-011 (Pk. 1), order separately! Two M8 fixing screws.

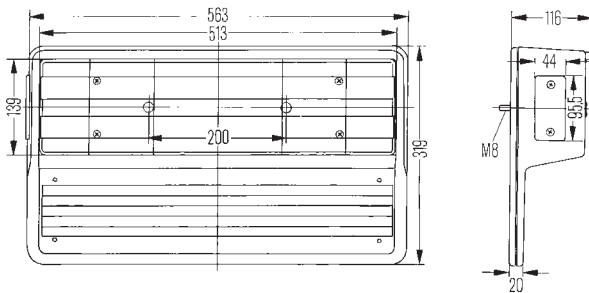

Part no.	Pk.	
2VD 005 300-551	1	Rear-reflector-stop-indicator-rear fog-licence plate-reverse-clearance-side-marker light with reflector, left
2VD 005 300-581	1	right
Spare parts/Accessories:		
9EL 134 296-041	1	Lens with screws, left
9EL 134 296-051	1	right
9EL 134 301-001	4	Lens for licence plate illumination
8RA 003 326-011	20	Reflectors
9EL 134 301-011	1	Cover plate, black
8GA 002 071-131	10	R10W bulb, 12V
8GA 002 071-251	10	24V
8GA 002 073-121	10	P21W bulb, 12V
8GA 002 073-241	10	24V

For surface mounting

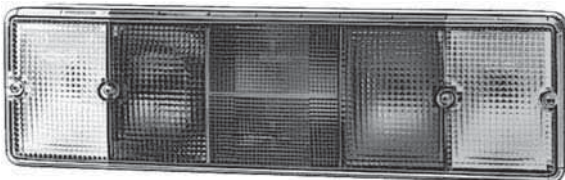

Red rear, stop and rear fog light, amber indicator light, white reverse light. With rectangular Volvo-central plug. Black plastic body. Two M6 fixing screws.

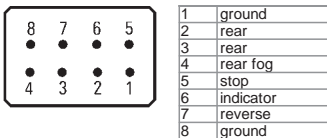
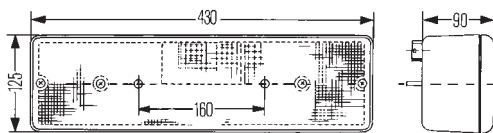

Part no.	Pk.	
2SL 005 883-031	1	Rear-stop-indicator-rear fog-reverse light with illumination for 520 x 120 mm and 340 x 240 mm licence plates, for horizontal surface mounting, left
2SL 005 883-041	1	right
2SK 005 883-011	1	Rear-stop-indicator-rear fog-reverse light for horizontal or vertical surface mounting, left
2SK 005 883-021	1	right
Spare parts/Accessories:		
9EL 135 548-001	1	Lens
8GA 002 071-121	10	R5W bulb, 12V
8GA 002 071-241	10	24V
8GA 002 073-121	10	P21W bulb, 12V
8GA 002 073-241	10	24V

For horizontal surface mounting

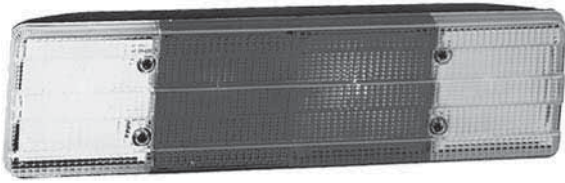

Red rear, stop, rear fog light and reflector, amber indicator light and white reverse light.
 Black plastic body, without grommet.
 Two M8 fixing screws.

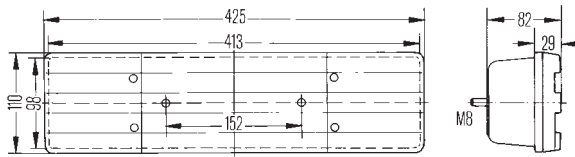

Part no.	Pk.	
2VB 004 887-011	1	Rear-reflector-stop-indicator-rear fog-lens plate light, left
2VA 004 887-031	1	Rear-reflector-stop-indicator-rear fog light, left
2VP 004 887-021	1	Rear-reflector-stop-indicator-reverse light, right
Spare parts/Accessories:		
9EL 131 420-001	1	Lens with screws, left
9EL 131 420-011	1	right
9GT 141 941-001	10	Grommet P21W bulb, 12V
8GA 002 073-121	10	24V
8GA 002 073-241	10	R10W bulb, 12V
8GA 002 071-131	10	24V
8GA 002 071-251	10	

For horizontal surface mounting on trailers

Rear Logic

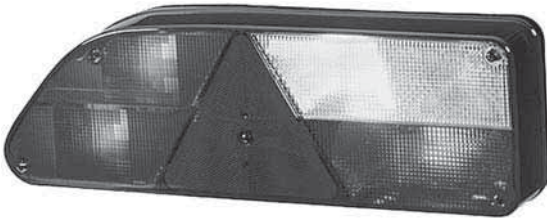

Red rear, stop, rear fog light and reflector, clear indicator light (with auxiliary lens) and reverse light. Black plastic body. With vibration dampers and grommet.
 Black plastic body.
 Two M8 fixing screws.

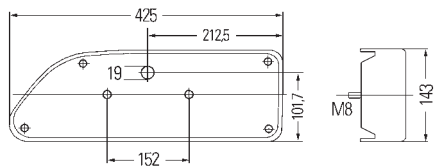

Part no.	Pk.	
2VP 007 907-031	1	Rear-triangular reflector-indicator-rear fog-reverse light, left
2VP 007 907-037	12	
2VP 007 907-041	1	right
2VP 007 907-047	12	
Spare parts/Accessories:		
9EL 150 965-001	1	Lens, left
9EL 150 966-001	1	right
8GA 002 073-251	10	P21W bulb, 24V
8GD 002 078-241	10	P21/5W bulb, 24V
8GD 002 078-011	10	24V (HD)

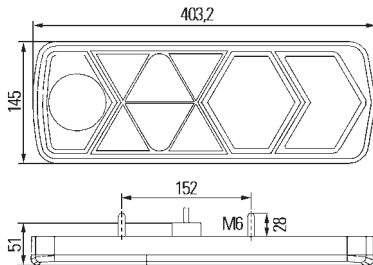
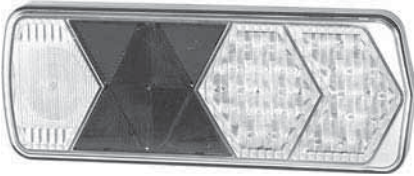

For horizontal surface mounting

In LED-technology. Red rear, stop light and reflector, amber indicator light, white reverse light.
 With 1500 mm long lead with blade receptacles 6.3 mm.
 Rear- and stop light each with 15 red LEDs, indicator light with 15 amber LEDs, reverse light with 1 white LED.
 Rear light: 0.7W, stop light: 5.0W, indicator light: 3.0W, reverse light: 5.5W.
 Black plastic body.
 Consumption at 24V:
 rear light: 0.03A, stop light: 0.21A, indicator light: 0.125A, reverse light: 0.23A.
 With pulse for indicator failure check.
 Type of protection: IP6K9K. See LED instruction 1.

Part no.	Pk.	
2VP 340 950-051	1	Rear-X-reflector-stop-indicator-reverse light, left and right

For horizontal surface mounting on trailers

Europoint

Red rear, stop, rear fog, clearance light and reflector, amber indicator light and side-marker light with reflector, white reverse light.
 Two bulbs for rear and stop light.
 With double vibration damping.
 Black plastic body.
 Two M8 fixing screws.

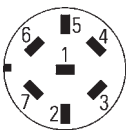
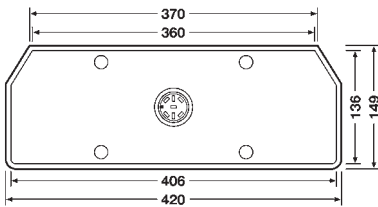

1	ground	white
2	stop	red
3	indicator	amber
4	reverse	grey
5	rear fog	blue
6	rear	black
7	side-marker/clearance/licence plate	brown



Part no.	Pk.	
2VD 008 789-011	1	Rear-reflector-stop-indicator-rear fog-reverse-clearance-side-marker-light licence plate light with 7-pole plug and 24V bulbs, left
2VP 008 789-051	1	Rear-reflector-stop-indicator-rear fog-reverse-clearance-side-marker light with 7-pole plug and 24V bulbs, left
2VP 008 789-021	1	right
2VP 008 789-071	1	Rear-reflector-stop-indicator-rear fog-reverse-clearance-side-marker light with PG- screwed connections, without plug and bulbs, left
2VP 008 789-041	1	right
Spare parts/Accessories:		
9EL 158 993-001	1	Lens with additional amber lens and expansion dowel
8GA 002 071-241	10	R5W bulb, 24V
8GA 002 071-251	10	R10W bulb, 24V
8GA 002 073-241	10	P21W bulb, 24V
8GD 002 078-241	10	P21/5W bulb, 24V

For horizontal, without licence plate illumination
also for vertical mounting on towing vehicles,
indicator light above

Also permissible for trailers in combination with
valid EC component homologation for lighting.
Red rear, stop, rear fog light and reflector,
amber indicator light, white reverse light.

Black plastic body. Two M8 fixing screws.

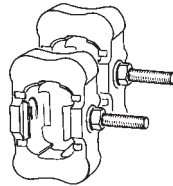
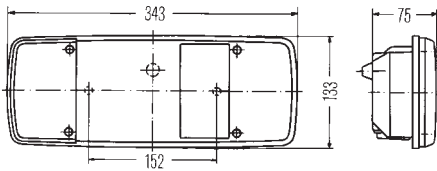
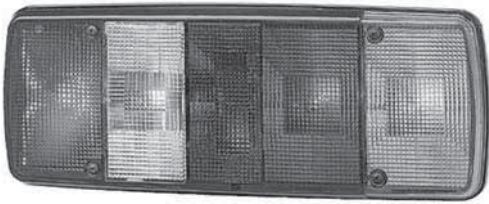

Part no.	Pk.	
2VP 003 567-111	1	Rear-reflector-stop-indicator-rear fog-reverse light, left
2VP 003 567-121	1	right
2VP 003 567-127	18	
2VD 003 567-371	1	Rear-reflector-stop-indicator-rear fog-reverse-licence plate light, two bulbs for rear light, left
9EL 122 689-021	2	Spare parts/Accessories: Lens with screws for -111/-121/-127
9GP 003 995-801	1	External vibration dampers Kit comprising: 2 each with M8 fixing screw
8GA 002 071-131	10	R10W bulb, 12V
8GA 002 071-251	10	24V
8GA 002 073-121	10	P21W bulb, 12V
8GA 002 073-241	10	24V

For horizontal, without licence plate illumination
also for vertical mounting on trailers,
indicator light above

Red rear, stop and rear fog light,
amber indicator light, white reverse light.
Black plastic body. Two M8 fixing screws.

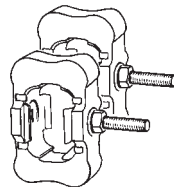
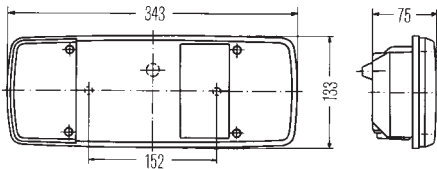
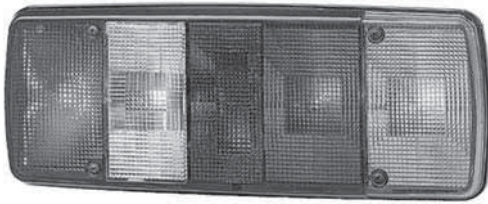

Part no.	Pk.	
2SK 003 567-331	1	Rear-stop-indicator-rear fog-reverse light, left
2SK 003 567-321	1	right
2SK 003 567-651	1	Rear-stop-indicator-rear fog-reverse light, two bulbs for rear light, left
2SK 003 567-661	1	right
2SL 003 567-311	1	Rear-stop-indicator-rear fog-reverse light, with licence plate illumination, left
2SL 003 567-691	1	Rear-stop-indicator-rear fog-reverse light, with licence plate illumination, two bulbs for rear light, left
9EL 122 772-001	2	Spare parts/Accessories: Lens with screws
9GP 003 995-801	1	External vibration dampers Kit comprising: 2 each with M8 fixing screw
8GA 002 071-131	10	R10W bulb, 12V
8GA 002 071-251	10	24V
8GA 002 073-121	10	P21W bulb, 12V
8GA 002 073-241	10	24V

For horizontal flush/surface mounting on towing vehicles and trailers

**Lens with various functions, left or right.
Red rear, reflector, stop and rear fog light,
amber indicator light, white reverse light.**

Black plastic body, with centre plug.

Without fixing screws.

Please plug the existing licence plate opening with cover 9HB 126 601-001 if not used.

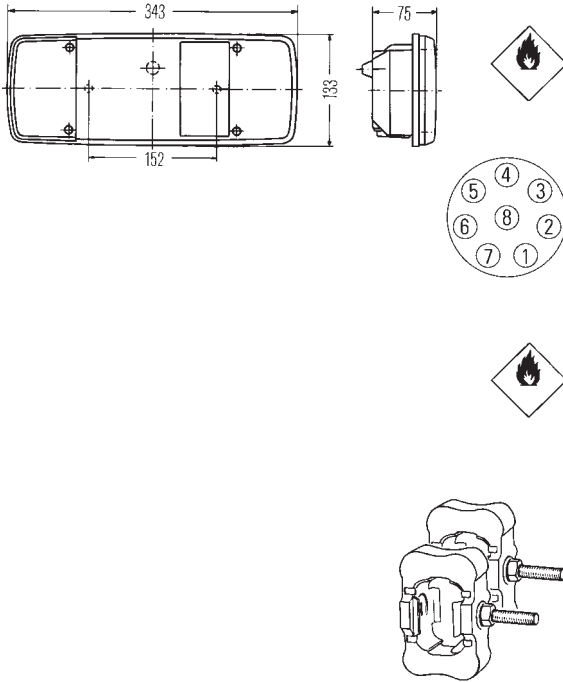
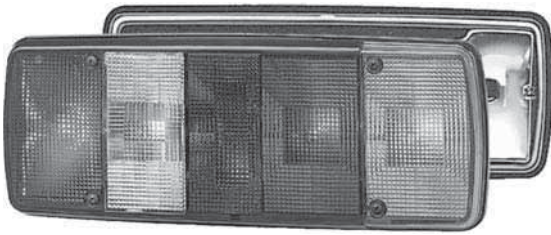

Part no.	Pk.	
9EL 122 689-051	2	Lenses with reflector for towing vehicles: for rear-reflector-stop-indicator-reverse light
9EL 122 689-021	2	for rear-reflector-stop-indicator-rear fog-reverse light
9BG 130 945-001	2	Body for lenses with reflector: left
9BG 130 946-001	2	right
9EL 122 772-051	2	Lenses without reflector for trailers: for rear-stop-indicator-reverse light
9EL 122 772-001	2	for rear-stop-indicator-rear fog-reverse light
9HB 126 601-001	2	Accessories: Cover for licence plate opening
9GP 003 995-801	1	External vibration dampers Kit comprising: 2 each with M8 fixing screw
8GA 002 071-131	10	R10W bulb, 12V
8GA 002 071-251	10	R10W bulb, 24V
8GA 002 073-121	10	P21W bulb, 12V
8GA 002 073-241	10	P21W bulb, 24V

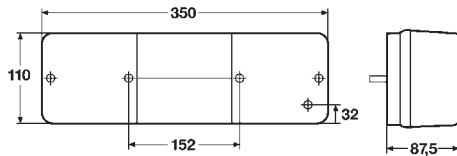

For horizontal or vertical surface mounting

Red rear and stop light, amber indicator light.
Licence plate opening can be replaced with red lens included loose.
 Black plastic body.
 Two M8 fixing screws.
 Two bulbs for rear light.
 With PG11- screwed connections.
 For older Scania models.

Part no.	Pk.	
2SE 997 088-001	1	Rear-stop-indicator-licence plate light, left and right
Spare parts/Accessories:		
9EL 997 441-001	1	Lens
8GA 002 071-131	10	R10W bulb, 12V
8GA 002 071-251	10	24V P21W bulb,
8GA 002 073-121	10	12V
8GA 002 073-241	10	24V

For horizontal surface mounting

Red rear and stop light, amber indicator light.
 Black plastic body, with grommet.
 Two M6 fixing screws.

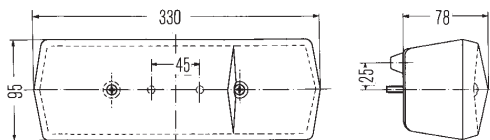
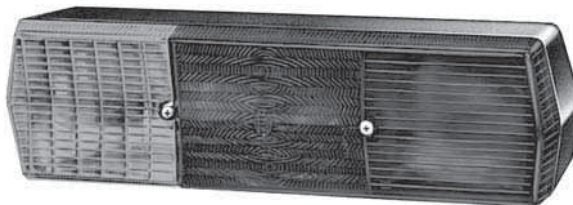

Part no.	Pk.	
2SD 001 688-171	1	Rear-stop-indicator light, left
2SD 001 688-141	1	right
Rear-stop-indicator light with illumination for 520 x 120 mm and 340 x 240 mm licence plates,		
2SE 001 688-151	1	left
2SE 001 688-161	1	right
Spare parts/Accessories:		
9EL 092 435-011	1	Lens with screws
9GD 102 484-001	10	Gasket for lens
9GT 074 132-001	10	Grommet
8GA 002 071-121	10	R5W bulb, 12V
8GA 002 071-241	10	24V P21W bulb,
8GA 002 073-121	10	12V
8GA 002 073-241	10	24V

For horizontal or vertical surface mounting
on towing vehicles

Coluna

In LED-technology. Red rear, stop, rear fog light and rectangular reflector, white indicator and reverse light. Rear light with 12 red LEDs, stop and rear fog light with each red 6 LEDs, indicator light with 6 amber LEDs, reverse light with 6 white LEDs.

Rear light: 2.6W, stop light: 1.8W, indicator light: 3.3W, rear fog light: 2.2W, reverse light: 3.8W at 12V.

Rear light: 2.8W, stop light: 2.0W, indicator light: 3.8W, rear fog light: 2.4W, reverse light: 5.6W at 24V.

Black body and lens-retaining rim.

Consumption at 12V:

rear light: 0.2A, stop light: 0.15A, indicator light: 0.28A, rear fog light: 0.18A, reverse light: 0.32A.

Consumption at 24V:

rear light: 0.12A, stop light: 0.08A, indicator light: 0.16A, rear fog light: 0.10A, reverse light: 0.23A.

See LED instruction 1.

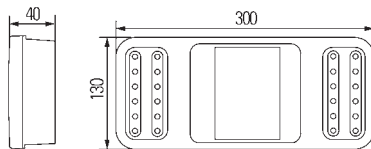

Part no.	Pk.	
		With 500 mm long lead with stripped ends. Two M8x 30 fixing screws.
		Rear-rectangular reflector-stop-indicator-rear fog-reverse light with pulse for indicator failure check, 12V
2VP 345 900-401	1	
		with pulse for indicator failure check, 24V
2VP 345 900-201	1	
		without pulse for indicator failure check, 12V
2VP 345 900-411	1	
		without pulse for indicator failure check, 24V
2VP 345 900-211	1	
<hr/>		
		With 500 mm long lead with stripped ends. Fixing screws at the rear.
		Rear-rectangular reflector-stop-indicator-rear fog-reverse light with pulse for indicator failure check, 12V
2VP 345 900-421	1	
		with pulse for indicator failure check, 24V
2VP 345 900-221	1	
		without pulse for indicator failure check, 12V
2VP 345 900-431	1	
		without pulse for indicator failure check, 24V
2VP 345 900-231	1	

For horizontal or vertical surface mounting
on towing vehicles

Coluna

In LED-technology. Red rear, stop, rear fog light and triangular reflector, white indicator and reverse light. Rear light with 12 red LEDs, stop and rear fog light with each red 6 LEDs, indicator light with 6 amber LEDs, reverse light with 6 white LEDs.

Rear light: 2.6W, stop light: 1.8W, indicator light: 3.3W, rear fog light: 2.2W, reverse light: 3.8W at 12V.

Rear light: 2.8W, stop light: 2.0W, indicator light: 3.8W, rear fog light: 2.4W, reverse light: 5.6W at 24V.

Black body and lens-retaining rim.

Consumption at 12V:

rear light: 0.2A, stop light: 0.15A, indicator light: 0.28A, rear fog light: 0.18A, reverse light: 0.32A.

Consumption at 24V:

rear light: 0.12A, stop light: 0.08A, indicator light: 0.16A, rear fog light: 0.1A, reverse light: 0.23A.

See LED instruction 1.



2VP 345 900-441

1

With 3000 mm long lead and 6.3 mm blade terminals.
Two M8 x 30 fixing screws.

Rear-rectangular reflector-stop-indicator-rear fog-reverse light with pulse for indicator failure check, 12V

2VP 345 900-241

1

with pulse for indicator failure check, 24V



2VP 345 900-451

1

without pulse for indicator failure check, 12V

2VP 345 900-251

1

without pulse for indicator failure check, 24V

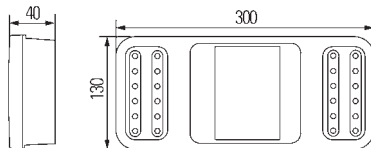

2VP 345 900-461

1

With 3000 mm long lead and 6.3 mm blade terminals.
Fixing screws at the rear.

Rear-rectangular reflector-stop-indicator-rear fog-reverse light with pulse for indicator failure check, 12V

2VP 345 900-261

1

with pulse for indicator failure check, 24V

2VP 345 900-471

1

without pulse for indicator failure check, 12V



2VP 345 900-271

1

without pulse for indicator failure check, 24V

For horizontal surface mounting on trailers

Coluna

In LED-technology. Red rear, stop, rear fog light and triangular reflector, white indicator and reverse light. Rear light with 12 red LEDs, stop and rear fog light with each red 6 LEDs, indicator light with 6 amber LEDs, reverse light with 6 white LEDs.

Rear light: 2.6W, stop light: 1.8W, indicator light: 3.3W, rear fog light: 2.2W, reverse light: 3.8W at 12V.

Rear light: 2.8W, stop light: 2.0W, indicator light: 3.8W, rear fog light: 2.4W, reverse light: 5.6W at 24V.

Black body and lens-retaining rim.

Consumption at 12V:

rear light: 0.2A, stop light: 0.15A, indicator light: 0.28A, rear fog light: 0.18A, reverse light: 0.32A.

Consumption at 24V:

rear light: 0.12A, stop light: 0.08A, indicator light: 0.16A, rear fog light: 0.10A, reverse light: 0.23A.

See LED instruction 1.

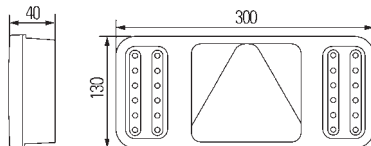

Part no.	Pk.	
		With 500 mm long lead with stripped ends. Fixing screws at the rear.
		Rear-triangular reflector-stop-indicator-rear fog-reverse light without pulse for indicator failure check, left, 12V
2VP 345 900-331	1	
2VP 345 900-341	1	without pulse for indicator failure check, right, 12V
2VP 345 900-131	1	with pulse for indicator failure check, left, 24V
2VP 345 900-141	1	with pulse for indicator failure check, right, 24V
		With 1000 mm long lead and 7-pole EasyConn socket. Fixing screws at the rear.
		Rear-triangular reflector-stop-indicator-rear fog-reverse light with pulse for indicator failure check, left, 24V
2VP 345 900-011	1	
2VP 345 900-021	1	with pulse for indicator failure check, right, 24V
		With 1000 mm long lead and 7-pole AMP plug connector. Fixing screws at the rear.
		Rear-triangular reflector-stop-indicator-rear fog-reverse light with pulse for indicator failure check, left, 24V
2VP 345 900-091	1	
2VP 345 900-101	1	with pulse for indicator failure check, right, 24V

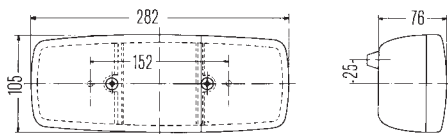

For horizontal surface mounting

Red rear and stop light, amber indicator light.

Black plastic body, with gasket.
Bulb holder with vibration damping.
Two M8 fixing screws.

Part no.	Pk.	
2SD 001 699-511	1	Rear-stop-indicator light, left
2SD 001 699-061	1	right
2SE 001 699-071	1	Rear-stop-indicator light with illumination for 340 x 240 mm and 240 x 130 mm licence plates, left
Spare parts/Accessories:		
9EL 109 139-001	2	Lens with screws
9GT 074 132-001	10	Grommet
8GA 002 071-131	10	12V R10W bulb,
8GA 002 071-251	10	24V P21W bulb,
8GA 002 073-121	10	12V
8GA 002 073-241	10	24V

Red rear and stop light, amber indicator light.

Black plastic body. With grommet.
Two M6 fixing screws.

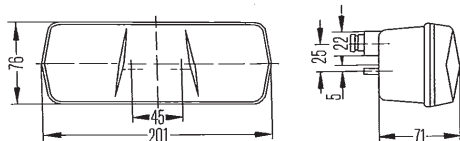
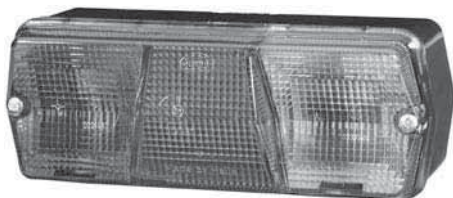

Part no.	Pk.	
2SD 001 680-271	1	Rear-stop-indicator light, left
2SD 001 680-281	1	right
2SD 001 680-391	1	Rear-stop-indicator light with PC-body, left
2SD 001 680-401	1	right
2SE 001 680-291	1	Rear-stop-indicator light with illumination for 520 x 120 mm, 340 x 240 mm and 240 x 130 mm licence plates, left
2SE 001 680-301	1	right
Spare parts/Accessories:		
9EL 107 368-001	2	Lens with screws and gasket, left
9EL 111 647-001	2	right
8GA 002 071-131	10	R10W bulb, 12V
8GA 002 073-121	10	P21W bulb, 12V

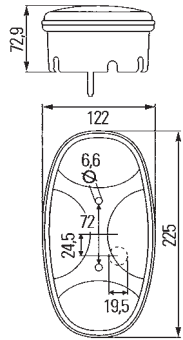

**For vertical surface mounting
on towing vehicles and trailers**

Cargoluna

Also permissible for trailers in combination with valid EC component homologation for lighting.

Red rear, stop light and reflector, amber indicator light, clear reverse light.

Black base plate. PC-lens.

With 5-pole DEUTSCH plug, seal and bulbs.

Black base plate. PC-lens.

Four M6 x 25 fixing screws.

Water drain hole broken out.

Completely mounted.

Vertical attachment: indicator light on inside.

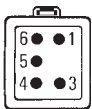

1	stop
3	rear
4	ground
5	reversing/rear fog
6	indicator
left	



1	reverse
3	rear
4	ground
5	stop
6	indicator
right	



Part no.	Pk.	
2VP 343 640-277	36	Rear-reflector-stop-indicator-reverse light with 12V bulbs, left
2VP 343 640-267	36	right
2VP 343 640-247	36	Rear-reflector-stop-indicator-reverse light with 24V bulbs, right
Spare parts:		
9EL 343 143-001	1	Lens for -277/-257
9EL 343 142-001	1	Lens for -267/-247
8GA 002 071-131	10	R10W bulb, 12V
8GA 002 071-251	10	R10W bulb, 24V
8GA 002 073-121	10	P21W bulb, 12V
8GA 002 073-241	10	P21W bulb, 24V

Signal lights

343 640 series



**For horizontal surface mounting
on towing vehicles and trailers**

Cargoluna

Also permissible for trailers in combination with valid EC component homologation for lighting. Red rear, stop, rear fog light and reflector, amber indicator light, clear reverse and licence plate light.

With gasket, DEUTSCH plug and bulbs.
Completely mounted.

Black base plate. PC-lens
Four M6 x 25 fixing screws.

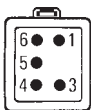
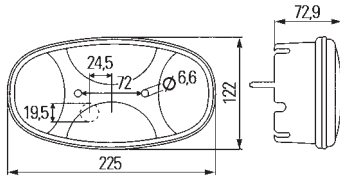

1	stop
3	rear
4	ground
5	reversing/rear fog
6	indicator

left

1	reverse
3	rear
4	ground
5	stop
6	indicator

right



Part no.	Pk.	
2VP 343 640-051	1	Rear-reflector-stop-indicator-reverse light, left, 12V
2VP 343 640-057	36	
2VP 343 640-041	1	right, 12V
2VP 343 640-047	36	
2VP 343 640-091	1	left, 24V
2VP 343 640-097	36	
2VP 343 640-081	1	right, 24V
2VP 343 640-087	36	
2VA 343 640-131	1	Rear-reflector-stop-indicator-rear fog light, left, 12V
2VA 343 640-137	36	
2VB 343 640-127	36	Rear-reflector-stop-indicator-rear fog-licence plate light, 12V, left
2VB 343 640-297	36	
2VA 343 640-117	36	Rear-reflector-stop-indicator-rear fog light, left, 24V
2VA 343 640-207	36	
9EL 343 143-001	1	Spare parts/Accessories: Lens for -051/-057/-091/-097
9EL 343 143-011	1	
9EL 343 142-001	1	
8GA 002 071-131	10	12V
8GA 002 071-251	10	
8GA 002 073-121	10	24V
8GA 002 073-241	10	

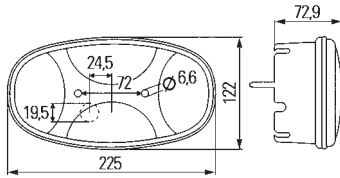

For horizontal or vertical surface mounting on towing vehicles and trailers

Cargoluna

Also permissible for trailers in combination with valid EC component homologation for lighting. Red rear, stop, rear fog light and reflector, amber indicator light, clear reverse and licence plate illumination.

With grommet and seal, without bulbs.

Lights are not mounted.

Black base plate. PC-lens

Four M6 x 25 fixing screws.

Caution: The water drainage opening must be knocked out according to the attachment position!

Please refer to the installation instructions.

Horizontal attachment: indicator light on top.

Vertical attachment: indicator light on inside.

Part no.	Pk.	
2VB 343 640-011	1	Rear-reflector-stop-indicator-rear fog-licence plate light, for horizontal mounting, left, 12V/24V
2VP 343 640-031	1	Rear-reflector-stop-indicator-reverse light, 12V/24V, left
2VP 343 640-021	1	right, 12V/24V
2VP 343 640-027	72	
2VA 343 640-071	1	Rear-reflector-stop-indicator-rear fog light, 12V/24V, left
2VA 343 640-077	72	
Spare parts/Accessories:		
Lens		
9EL 343 143-001	1	for -031/-037
9EL 343 143-011	1	for -011/-071/-077
9EL 343 142-001	1	for -021/-027
R10W bulb,		
8GA 002 071-131	10	12V
8GA 002 071-251	10	24V
P21W bulb,		
8GA 002 073-121	10	12V
8GA 002 073-241	10	24V

Signal lights

006 040 series



For horizontal surface mounting on towing vehicles

Also permissible for trailers in combination with valid EC component homologation for lighting.

Red rear, stop, rear fog light and reflector, amber indicator light, clear reverse light,

Black base plate.

Four 6 mm dia. holes for fixing screws.

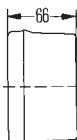
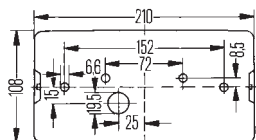

1	stop	stop
2	indicator	indicator
3	rear	rear
4	reversing/rear fog	reversing/rear fog
5	ground	black
6	-	not used



Part no.	Pk.	Description
2VB 006 040-051	1	Rear-reflector-stop-indicator-rear fog-licence plate light, with illumination for 520 x 120 mm and 340 x 240 mm licence plates, with grommet, left
2VA 006 040-071	1	Rear-reflector-stop-indicator-rear fog light, with grommet, left
2VA 006 040-077	10	
2VP 006 040-111	1	Rear-reflector-stop-indicator-reverse light with grommet, left
2VP 006 040-117	25	
2VP 006 040-121	1	right
2VP 006 040-127	25	
2VP 006 040-437	20	Rear-reflector-stop-indicator light with 6-pole DEUTSCH plug connector and 1000 mm long lead and 12V bulbs, without gasket, left
2VP 006 040-447	20	right
2VP 006 040-397	20	Rear-reflector-stop-indicator light with 6-pole DEUTSCH plug connector, 1000 mm long lead, 24V bulbs and gasket, left
2VP 006 040-407	20	right
2VP 006 040-477	20	Rear-reflector-stop-indicator light with PC lens, with 6-pole DEUTSCH plug connector, 1000 mm long lead, 24V bulbs and gasket, left
2VP 006 040-487	20	right
Spare parts/Accessories:		
		Lens,
9EL 136 833-011	1	left, for -051
9EL 136 819-031	1	left, for -071/-077
9EL 136 825-001	1	left, for -111/-117/-397/-437
9EL 136 825-011	1	right, for -121/-127/-407/-447
9GD 102 484-001	10	Gasket for extreme loads
		R10W bulb,
8GA 002 071-131	10	12V
8GA 002 071-251	10	24V
		P21W bulb,
8GA 002 073-121	10	12V
8GA 002 073-241	10	24V

For vertical surface mounting on towing vehicles and trailers

Also permissible for trailers in combination with valid EC component homologation for lighting.

Rear-reflector-stop-indicator-rear fog light, amber indicator light, clear reverse light.

Black base plate. With grommet.

Four 6 mm dia. holes for fixing screws.

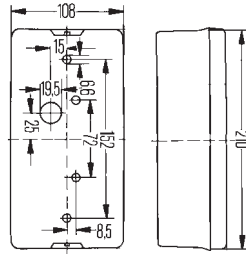

Part no.	Pk.	
2VA 006 040-291	1	Rear-reflector-stop-indicator-rear fog light, left
2VP 006 040-351	1	Rear-reflector-stop-indicator-reverse light, left
2VP 006 040-357	64	
2VP 006 040-301	1	right
2VP 006 040-307	64	
9GD 102 484-001	10	Spare parts: Gasket for extreme loads
8GA 002 071-131	10	R10W bulb, 12V
8GA 002 071-251	10	24V
8GA 002 073-121	10	P21W bulb, 12V
8GA 002 073-241	10	24V

For horizontal surface mounting on trailers

Red rear, stop and rear fog light, amber indicator light.

Black base plate. With grommet.

Four 6 mm dia. holes for fixing screws.

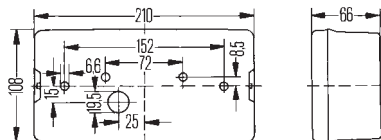
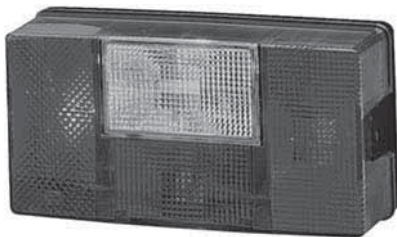

Part no.	Pk.	
2SE 006 040-011	1	Rear-stop-indicator-rear fog-licence plate light with illumination for 520 x 120 mm and 340 x 240 mm licence plates, left
2SD 006 040-031	1	Rear-stop-indicator-rear fog light, left
2SD 006 040-037	10	
2SD 006 040-041	1	right
2SD 006 040-161	1	Rear-stop-indicator light, right
2SD 006 040-167	10	
9EL 136 833-001	1	Spare parts/Accessories: Lens, left, for -011
9EL 136 819-011	1	left, for -031/-037
9EL 137 792-011	1	right, for -041
9EL 137 792-011	1	right, for -161/-171
9GD 102 484-001	10	Gasket for extreme loads
8GA 002 071-131	10	R10W bulb, 12V
8GA 002 071-251	10	24V
8GA 002 073-121	10	P21W bulb, 12V
8GA 002 073-241	10	24V

For vertical surface mounting on trailers

Red rear, stop and rear fog light, amber indicator light

Black base plate. With grommet.
Four 6 mm dia. holes for fixing screws.

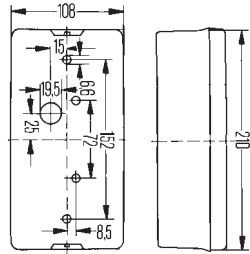

Part no.	Pk.	
2SD 006 040-131	1	Rear-stop-indicator-rear fog light, left
2SD 006 040-137	10	
2SD 006 040-141	1	Rear-stop-indicator light, right
2SD 006 040-147	10	
Spare parts/Accessories:		
		Lens,
9EL 136 819-041	1	left
9EL 137 792-031	1	right
9GD 102 484-001	10	Gasket for extreme loads
8GA 002 071-131	10	12V
8GA 002 071-251	10	24V
		P21W bulb,
8GA 002 073-121	10	12V
8GA 002 073-241	10	24V

For horizontal or vertical (indicator light above) surface mounting

Red rear, stop and rear fog light, amber indicator light, with illumination for 520 x 120 mm and 340 x 240 mm licence plates.

Black base plate, with grommet. Two M6 fixing screws.

Distance between screws 72 mm or 152 mm.

Licence plate opening can be replaced

with red lens included loose

(for use as rear-stop-indicator light).

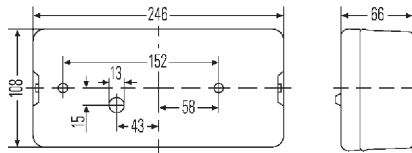
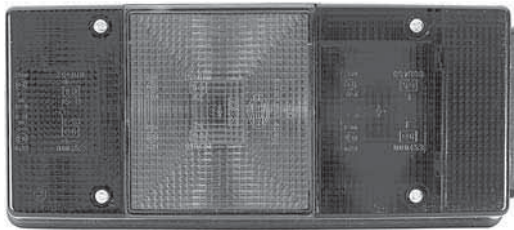

Part no.	Pk.	
2SE 007 547-011 2SE 007 547-017	1 30	Rear-stop-indicator-rear fog-licence plate light, left
2SE 007 547-021 2SE 007 547-027	1 25	right
2VB 007 547-171	1	Rear-reflector-stop-indicator-rear fog-licence plate light, left
2SE 007 547-041	1	Rear-stop-indicator-licence plate light, right
9EL 147 096-001 9EL 147 096-031 8GA 002 071-131 8GD 002 078-121 8GA 002 073-121	1 1 10 10 10	Spare parts/Accessories: Lens with licence plate window and red lens for -011/-017/-021/-027/-041 for -171 R10W bulb, 12V P21/5W bulb, 12V P21W bulb, 12V
2SL 007 547-061 2SL 007 547-067	1 30	Rear-stop-indicator-reverse-licence plate light, right
2VD 007 547-181	1	Rear-reflector-stop-indicator-licence plate light, right
9EL 147 097-001 9EL 147 096-021 8GA 002 071-131 8GD 002 078-121 8GA 002 073-121	1 1 10 10 10	Spare parts/Accessories: Lens with licence plate window and red lens for -061/-067 for -181 R10W bulb, 12V P21/5W bulb, 12V P21W bulb, 12V

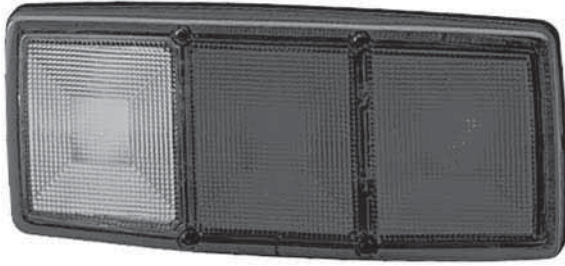

For horizontal or vertical flush/surface mounting

Red rear and stop light, amber indicator light,
clear licence plate light.
Black plastic body.
Two M8 fixing screws.

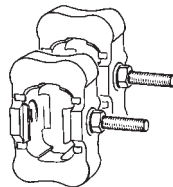
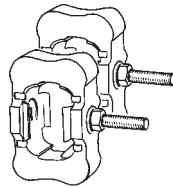
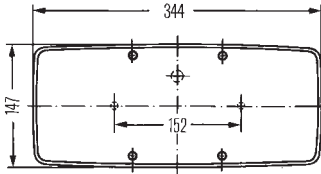

Part no.	Pk.	
2SD 003 167-011	1	Rear-stop-indicator light, left
2SD 003 167-021	1	right
2SD 003 167-531	1	Rear-stop-indicator light with PC body, left
2SD 003 167-541	1	right
2SE 003 167-031	1	Rear-stop-indicator light, with illumination for 520 x 120 mm and 340 x 240 mm licence plates, for horizontal surface mounting, left
2SE 003 167-041	1	right
Spare parts/Accessories:		
9EL 147 747-001	1	Lens with screws
9EL 147 747-007	306	
9GD 087 883-355	10	Gasket
9GP 003 995-801	1	External vibration dampers
8GA 002 073-121	10	Kit comprising: 2 each with M8 fixing screw
8GA 002 073-241	10	P21W bulb, 12V
8GA 002 071-131	10	24V R10W bulb,
8GA 002 071-251	10	12V 24V
2SD 003 167-521	3	Rear-stop-indicator light for double-filament bulb in stop-light section for additional rear-light function for horizontal surface mounting, right (only for spare parts requirement)
Spare parts/Accessories:		
9GD 087 883-355	10	Gasket
9GP 003 995-801	1	External vibration dampers
8GA 002 071-131	10	Kit comprising: 2 each with M8 fixing screw
8GA 002 071-251	10	R10W bulb, 12V
8GA 002 073-121	10	24V P21W bulb,
8GA 002 073-241	10	12V 24V
8GD 002 078-121	10	P21/5W bulb, 12V
8GD 002 078-241	10	24V
8GD 002 078-011	10	24V (HD)

For horizontal flush mounting

Red rear, stop and rear fog light, amber indicator light, white reverse light.

Four B4.8 x 25 x 15 fixing screws.

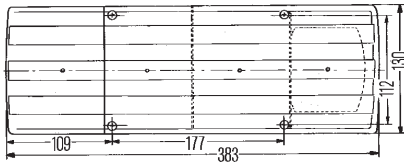
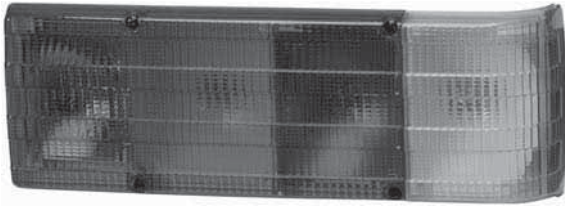

Part no.	Pk.	
2SD 004 460-001	1	Rear-stop-indicator-rear fog light with 12V bulbs
2SD 004 460-011	1	Rear-stop-indicator light with 12V bulbs
2SD 004 460-017	16	
2SB 004 460-061	1	Rear-stop-rear fog light without bulbs
Spare parts/Accessories:		
8GA 002 071-131	10	R10W bulb, 12V
8GA 002 073-121	10	P21W bulb, 12V
2SK 004 460-031	1	Rear-stop-indicator-rear fog-reverse light with 12 bulbs
2SK 004 460-037	16	
2SK 004 460-041	1	Rear-stop-indicator-reverse light with 12 bulbs
Spare parts:		
8GD 002 078-121	10	P21/5W bulb, 12V
8GA 002 073-121	10	P21W bulb, 12V

For flush mounting

Caraluna X

For caravan-trailers and mobile homes.

For flush mounting in trailer a separate triangular reflector is required.

Red rear, stop and rear fog light,
clear indicator light (amber bulb), clear reverse light.

Rear light in LED-technology 12V0.7W,
stop-, indicator-, rear fog- and reverse light
in bulb-technology 12V21W.

With LEDs, bulbs and 2-pole Delphi plug connector.

Consumption

rear light: 0.06A,

stop light, indicator light, rear fog light and reverse light: 1.75A.

Three ST4.8 fixing screws. Type of protection: IP54K and IPX9K.

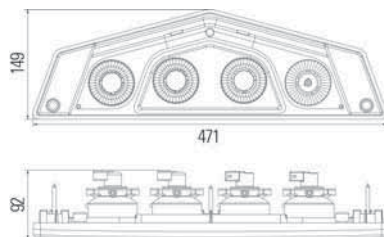
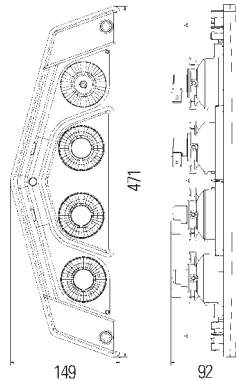

Part no.	Pk.	
		For vertical flush mounting, optical fiber inside.
2VP 012 570-111	1	Rear-reflector-stop-indicator-rear fog-reverse light, left
2VP 012 570-121	1	right
		For horizontal flush mounting, optical fiber on top.
2VP 012 570-131	1	Rear-reflector-stop-indicator-rear fog-reverse light, left
2VP 012 570-141	1	right
		For horizontal flush mounting, optical fiber below.
2VP 012 570-151	1	Rear-reflector-stop-indicator-rear fog-reverse light, left
2VP 012 570-161	1	right
		For horizontal flush mounting, optical fiber below, 13°.
2VP 012 570-171	1	Rear-reflector-stop-indicator-rear fog-reverse light, left
2VP 012 570-181	1	right
		Spare parts/Accessories:
8GA 002 073-121	10	P21W bulb, 12V
8GA 006 841-121	10	PY21W bulb, 12V
8GH 008 417-001	10	H21W bulb, 12V
8JD 156 150-807	1	Delphi plug-set, 2-pole (Contents: 20 pieces)

For flush mounting

Caraluna X

For caravan-trailers and mobile homes.

For flush mounting in trailer a separate triangular reflector is required.

Red rear, stop and rear fog light,
clear indicator light (amber bulb), clear reverse light.

Rear light: 12V5W,

stop-, indicator-, rear fog- and reverse light: 12V21W.

With bulbs, 2-pole Delphi- and 3-pole AMP plug connectors.

Three fixing screws ST4.8.

Type of protection: IP5K4K, IPX9K.

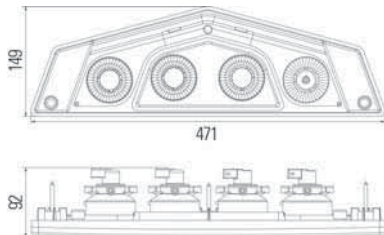
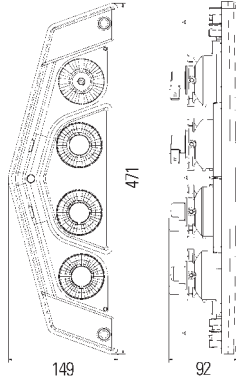

Part no.	Pk.	
		For vertical flush mounting, optical fiber inside.
		Rear-reflector-stop-indicator-rear fog-reverse light,
2VP 012 570-011	1	left
2VP 012 570-021	1	right
		For horizontal flush mounting, optical fiber on top.
		Rear-reflector-stop-indicator-rear fog-reverse light,
2VP 012 570-031	1	left
2VP 012 570-041	1	right
		For horizontal flush mounting, optical fiber below.
		Rear-reflector-stop-indicator-rear fog-reverse light,
2VP 012 570-051	1	left
2VP 012 570-061	1	right
		For horizontal flush mounting, optical fiber below, 13°.
		Rear-reflector-stop-indicator-rear fog-reverse light,
2VP 012 570-071	1	left
2VP 012 570-081	1	right
		Spare parts/Accessories:
8GD 002 078-121	10	P21/5W bulb, 12V
8GA 002 073-121	10	P21W bulb, 12V
8GA 006 841-121	10	PY21W bulb, 12V
8GH 008 417-001	10	H21W bulb, 12V
8JD 156 150-807	1	Delphi plug-set, 2-pole (Contents: 20 pieces)
8JD 162 581-802	1	AMP plug-set, 3-pole (20 pieces)

For vertical surface mounting

Caraluna Modular

For caravan-trailers and mobile homes.

Red rear, stop, rear fog light,
clear indicator light (with amber bulb)
and clear reverse light.

With seal. Four fixing screws ST4.8.

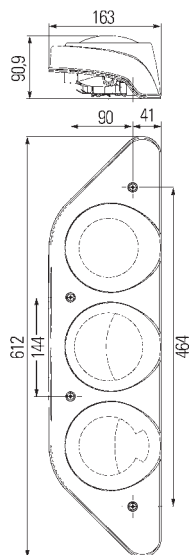

Part no.	Pk.	
2VP 343 520-011	1	Rear-stop-indicator-rear fog-reverse-side-marker light with reflector, with 12V bulbs, left
2VP 343 520-017	18	
2VP 343 520-021	1	with 12V bulbs, right
2VP 343 520-027	18	
2VP 343 520-037	18	with 24V bulbs, left
2VP 343 520-047	18	with 24V bulbs, right
<hr/>		
2VP 343 520-051	1	Rear-stop-indicator-rear fog-reverse-side-marker light with reflector, chrome-plating applied in the body shimmers through the lens, with 12V bulbs, left
2VP 343 520-057	18	
2VP 343 520-061	1	right
2VP 343 520-067	18	
Spare parts/Accessories:		
8GA 002 073-121	10	P21W bulb, 12V
8GA 002 073-241	10	24V R10W bulb,
8GA 002 071-131	10	12V
8GA 002 071-251	10	24V
		PY21W bulb,
8GA 006 841-121	10	12V
8GA 006 841-241	10	24V
8RA 344 065-007	144	Reflector, red, self-adhesive

For vertical flush mounting

Caraluna Vertical

For caravan-trailers and mobile homes.
 Red rear, stop, rear fog light,
 clear indicator light (with amber bulb)
 and clear reverse light.
 With 12V bulbs.

Two fixing screws ST4.8.

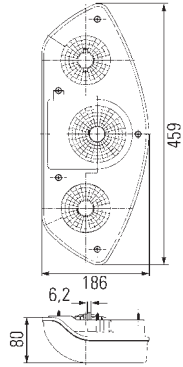

Part no.	Pk.	
2SD 343 440-017	10	Rear-stop-indicator-rear fog light, left
2SK 343 440-027	10	Rear-stop-indicator-reverse light, right
2SD 343 440-057	10	Rear-stop-indicator-rear fog light with smoke coloured lens, left
2SK 343 440-067	10	Rear-stop-indicator-reverse light with smoke coloured lens, right
2SK 343 440-037	10	Rear-stop-indicator-reverse light, left
2SD 343 440-047	10	Rear-stop-indicator-rear fog light, right
Spare parts:		
8GA 002 073-121	10	P21W bulb, 12V
8GD 002 078-121	10	P21/5W bulb, 12V
8GA 006 841-121	10	PY21W bulb, 12V

For horizontal flush mounting

Caraluna I

For caravan-trailers. With triangular reflector.
 For mobile homes. With rectangular reflector.
 Red rear, stop, rear fog light and reflector,
 and side-marker light with reflector,
 clear indicator light and white reverse light.
 With 12V bulbs.

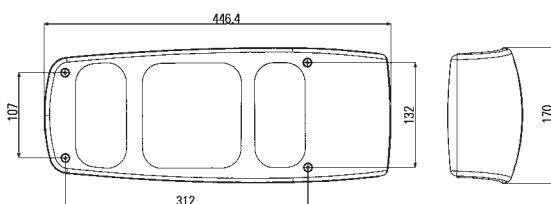
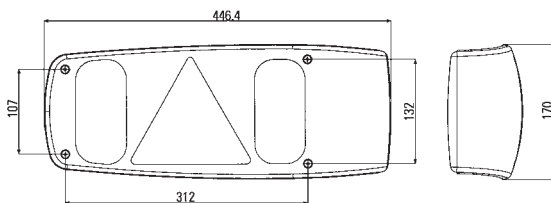
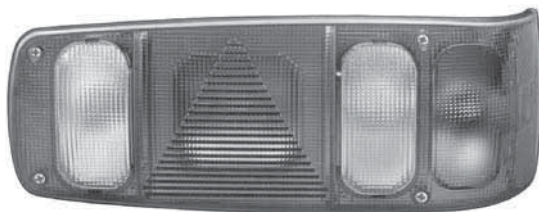
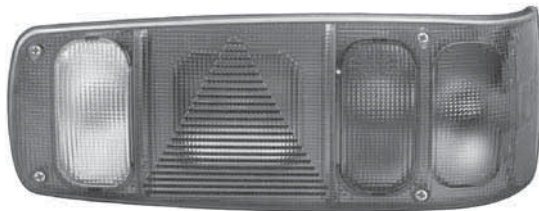

Part no.	Pk.		
2VA 007 502-011	1	Rear-triangular reflector-stop-indicator-rear fog-side-marker light with reflector, left	
2VA 007 502-017	12		
2VA 007 502-061	1	right	
2VP 007 502-031	1	Rear-triangular reflector-stop-indicator-reverse-side-marker light with reflector, left	
2VP 007 502-041	1		right
8GD 002 078-121	10	Spare parts: P21/5W bulb, 12V	
8GA 006 841-121	10		PY21W bulb, 12V
8GA 002 073-121	10		P21W bulb, 12V
2VA 007 502-021	1	Rear-triangular reflector-stop-indicator-side-marker light with reflector, right	
8GD 002 078-121	10	Spare parts: P21/5W bulb, 12V	
8GA 006 841-121	10		PY21W bulb, 12V
2VA 007 502-111	1	Rear-rectangular reflector-stop-indicator-rear fog-side-marker light with reflector, left	
2VA 007 502-117	12		
2VP 007 502-121	1	Rear-rectangular reflector-stop-indicator-reverse-side-marker light with reflector, right	
2VP 007 502-127	12		
8GD 002 078-121	10	Spare parts: P21/5W bulb, 12V	
8GA 006 841-121	10		PY21W bulb, 12V
8GA 002 073-121	10		P21W bulb, 12V

For horizontal flush mounting

Caraluna II

For caravan-trailers. With triangular reflector.
 For mobile homes. With round reflector.
 Red rear, stop, rear fog light and reflector
 and side-marker reflector,
 clear indicator light (amber bulb), clear reverse light.
 With red lens and 12V bulbs.

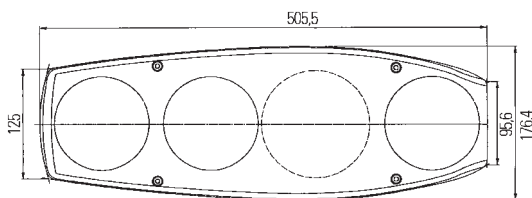
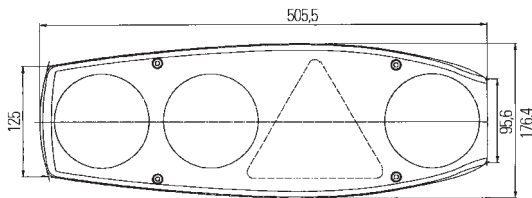

Part no.	Pk.	
2VA 341 419-011	1	Rear-stop-triangular reflector-indicator-rear fog-side-marker light with reflector, left
2VA 341 419-061	1	right
2VA 341 419-021	1	Rear-triangular reflector-stop-indicator-side-marker light with reflector, right
2VP 341 419-047	10	Rear-stop-triangular reflector-indicator-reverse-side-marker light with reflector, right
2VA 341 419-111	1	Rear-stop-indicator-rear fog-side-marker light with reflector, left
2VA 341 419-117	10	
2VA 341 419-147	1	right
2VP 341 419-137	1	Rear-stop-indicator-rear fog-reverse-side-marker light with reflector, left
2VP 341 419-121	1	right
2VP 341 419-127	10	
8GD 002 078-121	10	Spare parts: P21/5W bulb, 12V
8GA 006 841-121	10	PY21W bulb, 12V
8GA 002 073-121	10	P21W bulb, 12V

For horizontal flush mounting

Caraluna II

For caravan-trailers. With triangular reflector.
 For mobile homes. With round reflector.
 Red rear, stop, rear fog light and reflector,
 clear indicator light (amber bulb), clear reverse light.
 With smoke coloured lens and 12V bulbs.

Chrome-plating applied in the body
 shimmers through the lens.

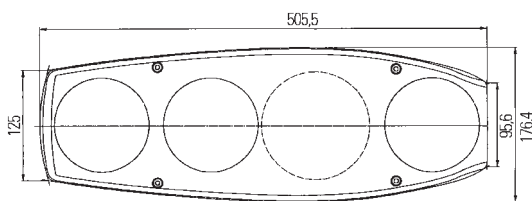
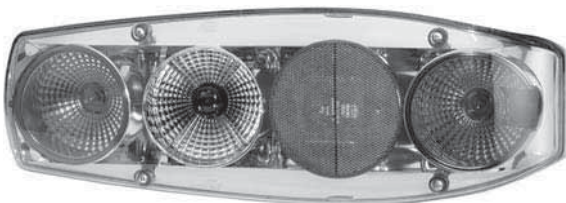
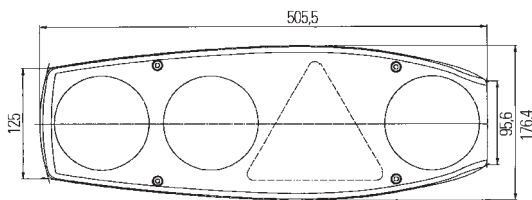
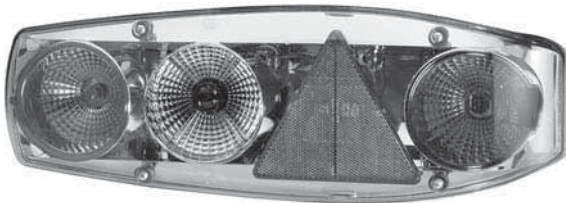

Part no.	Pk.	
2VA 341 419-097	10	Rear-triangular reflector-stop-indicator-rear fog light, left
2VA 341 419-167	10	right
2VP 341 419-157	10	Rear-triangular reflector-stop-indicator-reverse light, left
2VP 341 419-107	10	right
2VA 341 419-077	10	Rear-reflector-stop-indicator-rear fog light, left
2VA 341 419-187	10	right
2VP 341 419-087	10	Rear-reflector-stop-indicator-reverse light, right
Spare parts:		
8GD 002 078-121	10	P21/5W bulb, 12V
8GA 006 841-121	10	PY21W bulb, 12V
8GA 002 073-121	10	P21W bulb, 12V

Caraluna II Plus

For caravan-trailers. With triangular reflector.
 Red rear, stop, rear fog light and reflector,
 and side-marker light with reflector,
 clear indicator light (amber bulb), clear reverse light.
 With red lens and 12V bulbs.

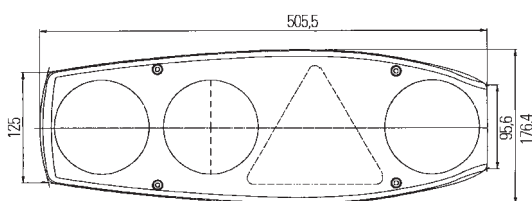

Part no.	Pk.	
2VP 343 590-017	10	Rear-stop-indicator-rear fog-reverse-side-marker light with reflector, left
2VP 343 590-027	10	right
Spare parts:		
8GD 002 078-121	10	P21/5W bulb, 12V
8GA 006 841-121	10	PY21W bulb, 12V
8GA 002 073-121	10	P21W bulb, 12V

For horizontal flush mounting

Caraluna II Plus

With triangular reflector for caravan-trailers.
Red rear, stop, rear fog light and reflector, clear indicator light (amber bulb), clear reverse light.
With smoke coloured lens and 12V bulbs.

Chrome-plating applied in the body
 shimmers through the lens.

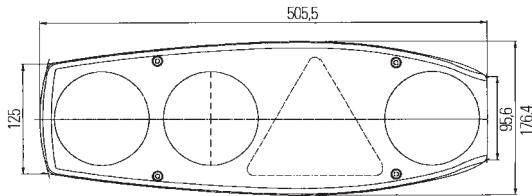

Part no.	Pk.	
2VP 343 590-057	10	Rear-reflector-stop-indicator-rear fog-reverse light, left
2VP 343 590-067	10	right
Spare parts:		
8GD 002 078-121	10	P21/5W bulb, 12V
8GA 006 841-121	10	PY21W bulb, 12V
8GA 002 073-121	10	P21W bulb, 12V

For horizontal or vertical flush mounting

Red rear and stop light, amber indicator light.
With grommet.

B4.2 x 13 self-tapping fixing screws.
 Only for spare parts requirement.

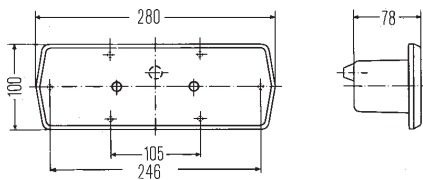
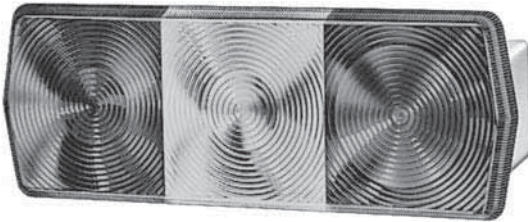

Part no.	Pk.	
2SD 001 693-011	1	Rear-stop-indicator light
Spare parts/Accessories:		
9GT 074 132-001	10	Grommet
8GA 002 071-131	10	R10W bulb, 12V
8GA 002 071-251	10	24V P21W bulb, 12V
8GA 002 073-121	10	12V
8GA 002 073-241	10	24V

For horizontal surface mounting

Red rear and stop light, amber indicator light.

Lens with snap fastening. Red plexiglass frame.
 Four 5.5 mm dia. holes for fixing screws.
 Only for spare parts requirement.

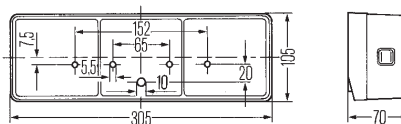

Part no.	Pk.	
2SD 003 409-327	18	Rear-stop-indicator-rear fog light with grey base plate, right
Spare parts:		
8GD 002 078-121	10	P21/5W bulb, 12V
8GA 002 073-121	10	P21W bulb, 12V

For horizontal flush/surface mounting

Red rear, reflector and stop light, amber indicator light.

Black plastic body. Two M6 fixing screws.
With plug connector.

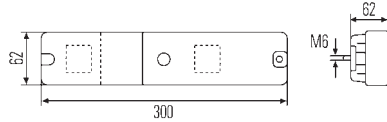

Part no.	Pk.	
2VA 997 113-001	1	Rear-reflector-stop-indicator light
2VA 997 113-011	63	
Spare parts:		
9EL 997 453-001	2	Lens
8GA 002 073-121	10	P21W bulb, 12V
8GA 002 073-241	10	P21W bulb, 24V
8GD 002 078-121	10	P21/5W bulb, 12V
8GD 002 078-241	10	P21/5W bulb, 24V
8GD 002 078-011	10	P21/5W bulb, 24V (Heavy Duty)

For horizontal surface mounting

Red rear, stop, rear fog light and triangular reflector, clear reverse light, white indicator light (amber bulb) and licence plate light.

With fixing material and grommet, without lead.

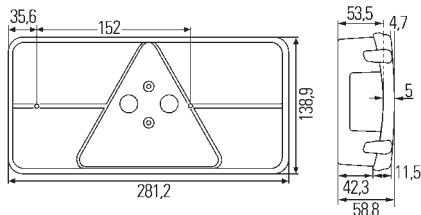
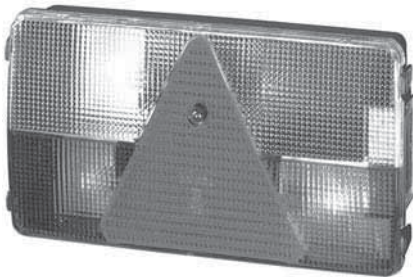

Part no.	Pk.	
2VB 341 032-111	1	Rear-reflector-stop-indicator-rear fog-licence plate light, left
2VB 341 032-117	10	
2VB 341 032-141	1	right
<hr/>		
2VB 341 032-121	1	Rear-reflector-stop-licence plate light, right
2VB 341 032-127	10	
<hr/>		
2VP 341 032-537	10	Rear-triangular reflector-stop-indicator-reverse-licence plate light with rear fog light, left
2VB 341 032-547	10	without rear fog light, right
Spare parts:		
9EL 341 255-011	1	Lens
8GD 002 078-121	10	P21/5W bulb, 12V
8GA 002 073-121	10	P21W bulb, 12V
8GA 006 841-121	10	PY21W bulb, 12V
8GM 002 092-121	10	C5W bulb, 12V

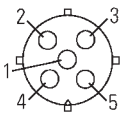
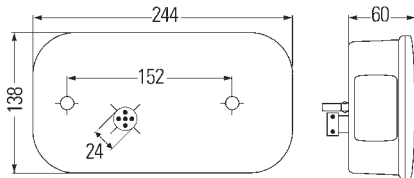
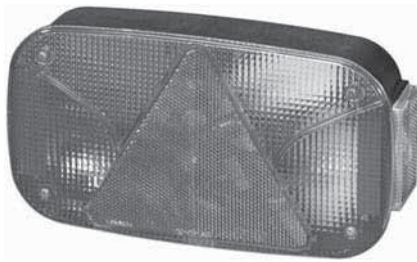

1	ground	white
2	indicator	green/yellow
3	stop	red
4	rear/licence plate/marker	black
5	rear fog or reverse	blue/free

For horizontal surface mounting

Red rear, stop, rear fog light and triangular reflector, amber indicator light and side marker light. White licence plate light.

With 5-pole central plug and 12V bulbs.

Black plastic body.
Two M6 fixing screws.

Part no.	Pk.	
2VB 998 232-011	1	Rear-triangular reflector-stop-indicator-rear fog light-licence plate light, for 520 x 120 mm licence plates, left
2VB 998 232-021	1	Rear-triangular reflector-stop-indicator-licence plate light, for 520 x 120 mm licence plates, right
Spare parts/Accessories:		
9EL 990 632-001	1	Lens
8GD 002 078-121	10	P21/5W bulb, 12V
8GA 002 073-121	10	P21W bulb, 12V
8GM 002 092-121	10	C5W bulb, 12V
8KA 998 230-121	1	7-pole lead set with two 5-pole plugs, 2500 mm, 12V

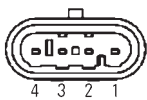
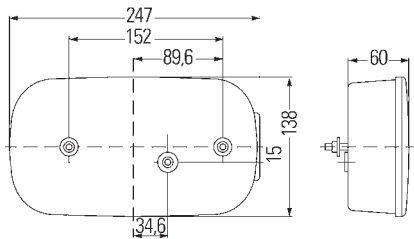
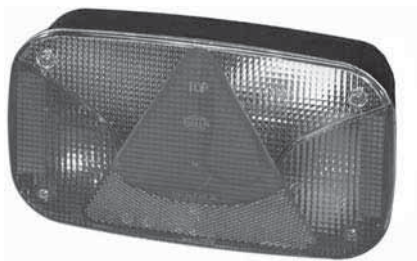

1	ground	white
2	stop	red
3	rear	brown
4	indicator	green

For horizontal surface mounting on towing vehicles

Red rear, stop light and rectangular reflector, indicator light (amber bulb) and clear licence plate light, amber side marker reflector.

With 4-pole AMP plug connector, 200 mm long lead and bulbs 12V.

Black plastic body.
Two M6 fixing screws.

Part no.	Pk.	
2VB 998 232-537	36	Rear-rectangular reflector-stop-indicator-side marker light with licence plate illumination, left
2VA 998 232-547	36	without licence plate illumination, right
Spare parts:		
9EL 990 632-041	1	Lens
8GD 002 078-121	10	P21/5W bulb, 12V
8GA 002 073-121	10	P21W bulb, 12V
8GA 006 841-121	10	PY21W bulb, 12V
8GM 002 092-121	10	C5W bulb, 12V

Signal lights

998 232 series

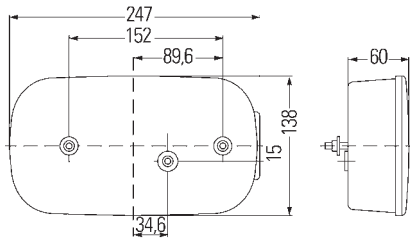
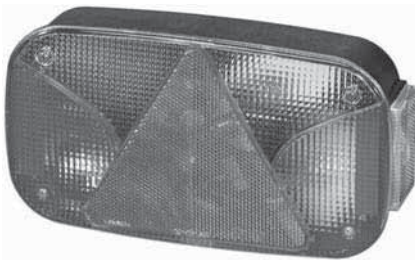

For horizontal surface mounting

Red rear, stop light and triangular reflector, indicator light (amber bulb) and clear licence plate light, amber side marker reflector.

With 200 mm long lead, grommet and bulbs 12V.

Black plastic body.
Two M6 fixing screws.

Part no.	Pk.	
2VB 998 232-557	36	Rear-rectangular reflector-stop-indicator-side marker light with licence plate illumination, left
2VA 998 232-567	36	without licence plate illumination, right
Spare parts:		
8GD 002 078-121	10	P21/5W bulb, 12V
8GA 002 073-121	10	P21W bulb, 12V
8GA 006 841-121	10	PY21W bulb, 12V
8GM 002 092-121	10	C5W bulb, 12V

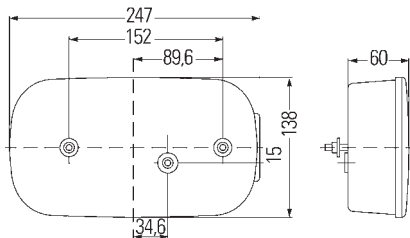
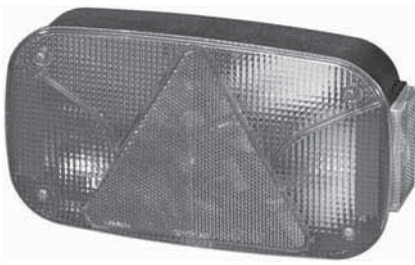

Red rear, stop, rear fog light and triangular reflector, amber indicator light and side marker light, white licence plate light.

With grommet, without bulbs and 5-pole central plug.

Black plastic body.
Two M6 fixing screws.

Part no.	Pk.	
2VB 998 232-211	1	Rear-triangular reflector-stop-indicator-rear fog light-licence plate light, for 520 x 120 mm licence plates, left
2VB 998 232-221	1	Rear-triangular reflector-stop-indicator-licence plate light, for 520 x 120 mm licence plates, right
Spare parts:		
9EL 990 632-001	1	Lens
8GD 002 078-121	10	P21/5W bulb, 12V
8GA 002 073-121	10	P21W bulb, 12V
8GM 002 092-121	10	C5W bulb, 12V

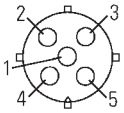
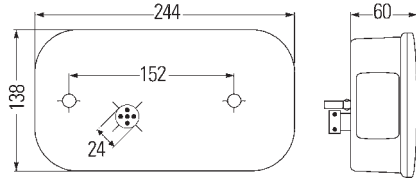
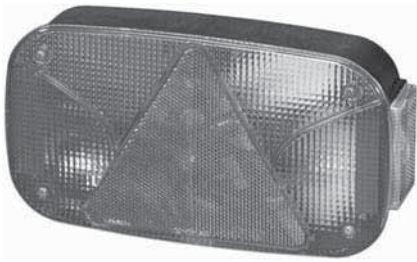

1	ground	white
2	indicator	green/yellow
3	stop	red
4	rear/licence plate/marker	brown/black
5	rear fog or reverse	blue/free

For horizontal surface mounting

Red rear, stop, rear fog light and triangular reflector, reverse light and indicator light white (amber bulb), amber side marker light.

With 5-pole central plug and 12V bulbs.

Black plastic body.

Two M6 fixing screws.

Part no.	Pk.	
2VB 998 232-131	1	Rear-triangular reflector-stop-indicator-rear fog-licence plate light, for 520 x 120 mm licence plates, left
2VB 998 232-101	1	Rear-triangular reflector-stop-indicator-licence plate light, for 520 x 120 mm licence plates, right
2VB 998 232-171	1	Rear-triangular reflector-stop-indicator-rear fog-side-marker-licence plate light, for 520 x 120 mm licence plates, left
2VB 998 232-201	1	Rear-triangular reflector-stop-indicator-side-marker-licence plate light, for 520 x 120 mm licence plates, right
		Spare parts/Accessories:
9EL 990 632-011	1	Lens
8GD 002 078-121	10	P21/5W bulb, 12V
8GA 002 073-121	10	P21W bulb, 12V
8GA 006 841-121	10	PY21W bulb, 12V
8GM 002 092-121	10	C5W bulb, 12V
8KA 998 230-121	1	7-pole lead set with two 5-pole plugs, 2500 mm, 12V

For horizontal flush/surface mounting

Red rear, stop, rear fog light and triangular reflector, reverse light and indicator light white (amber bulb), amber side marker light.

Black plastic body.

With two M6 fixing screws and grommet.

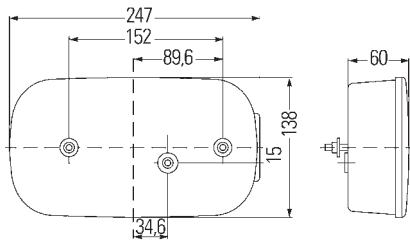
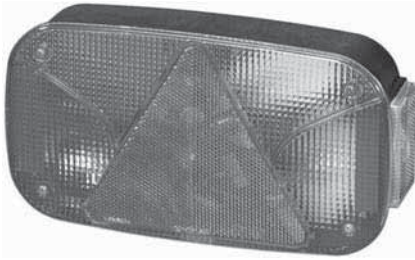

Part no.	Pk.	Description
2VB 998 232-231	1	Rear-triangular reflector-stop-indicator-rear fog-licence plate light, for 520 x 120 mm licence plates, for horizontal flush/surface mounting, without bulbs, left
2VB 998 232-241	1	Rear-triangular reflector-stop-indicator-licence plate light for 520 x 120 mm licence plates, for horizontal flush/surface mounting, without bulbs, right
2VA 998 232-251	1	Rear-triangular reflector-stop-indicator-rear fog light for horizontal flush/surface mounting, with bulbs 12V, left
2VP 998 232-261	1	Rear-triangular reflector-stop-indicator-reverse light for horizontal flush/surface mounting, with bulbs 12V, right
2VA 998 232-291	1	Rear-triangular reflector-stop-indicator-rear fog-side-marker light for horizontal flush/surface mounting, with 12V bulbs, left
2VP 998 232-301	1	Rear-triangular reflector-stop-indicator-reverse-side-marker light for horizontal flush/surface mounting, with 12V bulbs, right
9EL 990 632-011	1	Spare parts: Lens
8GD 002 078-121	10	P21/5W bulb, 12V
8GA 002 073-121	10	P21W bulb, 12V
8GA 006 841-121	10	PY21W bulb, 12V
8GM 002 092-121	10	C5W bulb, 12V

For vertical surface mounting

Red rear, stop, rear fog light and triangular reflector, amber indicator light. With 5-pole central plug and 12V bulbs.

Black plastic body.
With two M8 fixing screws.

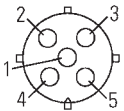
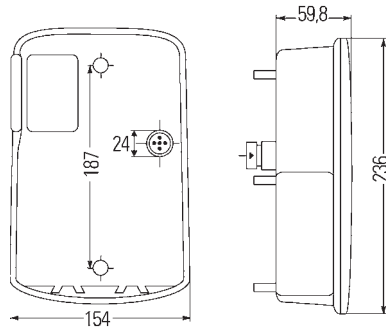
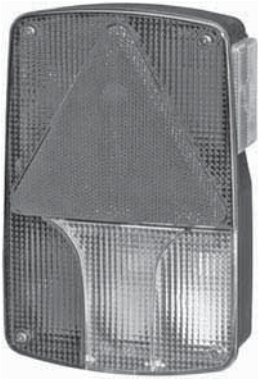

1	ground	white
2	indicator	green/yellow
3	stop	red
4	rear	brown/black
5	rear fog	blue/free

Part no.	Pk.	
2VA 998 233-367	36	Rear-triangular reflector-stop-indicator-rear fog light, right
2VA 998 233-357	36	Rear-triangular reflector-stop-indicator-rear fog light, with 200 mm long lead, left
Spare parts/Accessories:		
8GA 002 073-121	10	P21W bulb, 12V
8GM 002 092-121	10	C5W bulb, 12V
8KA 998 230-121	1	7-pole lead set with two 5-pole plugs, 2500 mm, 12V

Red rear, stop, rear fog light and triangular reflector, white indicator light (amber bulb), reverse light and position light, amber side marker reflector. With 5-pole central plug and 12V bulbs.

Black plastic body.

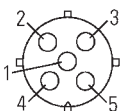
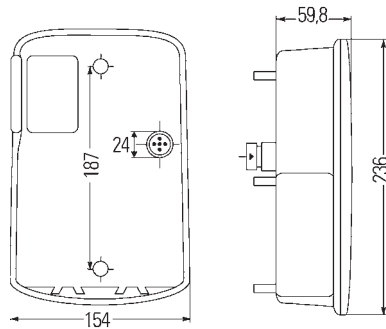
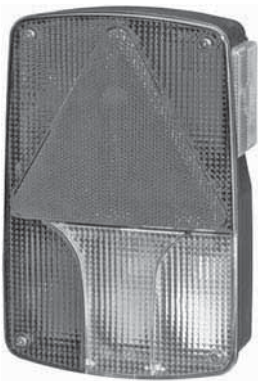

1	ground	white
2	indicator	green/yellow
3	stop	red
4	rear/licence plate/marker	brown/black
5	rear fog or reverse	blue/free

Part no.	Pk.	
2VA 998 233-271	1	Rear-triangular reflector- stop-indicator-rear fog light with side marker reflector and position light, with two M6 fixing screws, without quick mounting plate, left
2VP 998 233-281	1	Rear-triangular reflector-stop-indicator-reverse light with side marker reflector and position light, with two M6 fixing screws, without quick mounting plate, right
Spare parts/Accessories:		
Lens,		
9EL 990 633-031	1	left
9EL 990 633-041	1	right
8GA 002 073-121	10	P21W bulb, 12V
8GA 006 841-121	10	PY21W bulb, 12V
8GM 002 092-121	10	C5W bulb, 12V
8KA 998 230-121	1	7-pole lead set with two 5-pole plugs, 2500 mm, 12V

For horizontal or vertical surface mounting on Claas tractors and forklifts

LeanLED

In LED-technology. Clear lens. With 24 LEDs.
Rear light: 1.0W, stop light: 1.5W, indicator light: 2.0W.
 Consumption: 0.38A at 12V, 0.19A at 24V.
 Black plastic body.
 Two 3.0 mm dia. holes for fixing screws.
 Voltage range: 9V - 33V.
 See LED instruction 1.

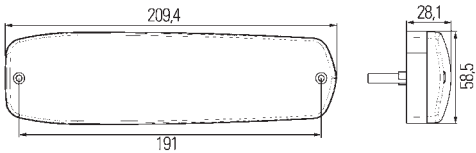

Part no.	Pk.	
2SD 343 910-001	1	Rear-stop-indicator light with 500 mm long lead
2SD 343 910-007	48	
2SD 343 910-017	48	with 200 mm long lead and 4-pole AMP-Superseal plug connector
2SD 343 910-027	48	without lead, with 4-pole AMP-Superseal plug connector
2SD 343 910-057	48	with 110 mm long lead and 4-pole DEUTSCH plug connector
8KW 744 808-801	1	Accessories: 4-pole Superseal set, for -017/-027

For horizontal surface mounting

Red rear, stop light and reflector, amber indicator light.
 With 12V bulbs and 4-pole John Deere central plug.



Part no.	Pk.	
2VA 006 356-101	1	Rear-reflector-stop-indicator light
9EL 147 992-001	1	Spare parts: Lens with screws
8GA 002 073-121	10	P21W bulb, 12V
8GD 002 078-121	10	P21/5W bulb, 12V

Red rear, stop light and reflector, amber indicator light.
 Lens with snap fastening.
 Two holes for M5 fixing screws. With plug connector.

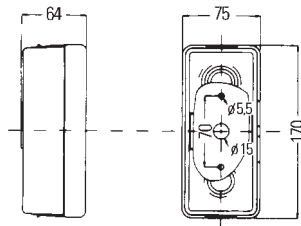

Part no.	Pk.	
2VA 998 531-031	1	Rear-reflector-stop-indicator light
9EL 997 310-001	1	Spare parts/Accessories: Lens
8GA 002 073-121	10	P21W bulb, 12V
8GA 002 073-241	10	24V
8GD 002 078-121	10	P21/5W bulb, 12V
8GD 002 078-241	10	24V

For horizontal or vertical surface mounting

Red rear and stop light, amber indicator light.

PC lens with snap fastening.
Two holes for M5 fixing screws. With plug connector.

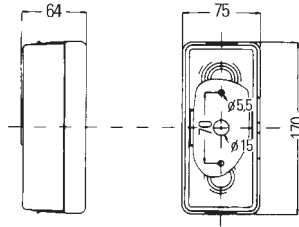
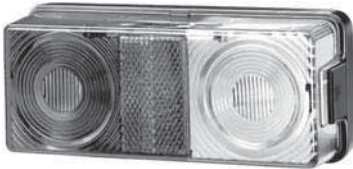

Part no.	Pk.	
2SD 998 531-057	1	Rear-stop-indicator light, left
2SD 998 531-067	1	right
Spare parts/Accessories:		
8GA 002 073-121	10	P21W bulb, 12V
8GA 002 073-241	10	24V
8GA 002 071-131	10	R10W bulb, 12V
8GA 002 071-241	10	24V

Red rear and stop light, amber indicator light, white licence plate light.

Plastic body. Four holes for M5 fixing screws. With grommet.
Exchangeable lens insert for licence plate lighting / no licence plate lighting.

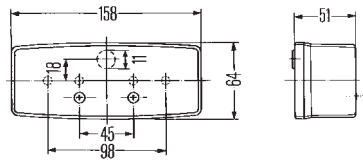

Part no.	Pk.	
2SE 997 111-011	1	Rear-stop-indicator-licence plate light, left
2SE 997 111-021	1	right
Spare parts/Accessories:		
9EL 997 451-001	1	Lens with screws and red lens insert, left
9EL 997 452-001	1	right
8GA 002 071-131	10	R10W bulb, 12V
8GA 002 071-251	10	24V
8GA 002 073-121	10	P21W bulb, 12V
8GA 002 073-241	10	24V

For horizontal surface mounting

Red rear and stop light, amber indicator light, clear licence plate light.

Black plastic body.
For Deutz-Fahr.
National type test for Germany.

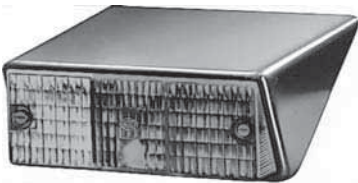

Part no.	Pk.	
2SE 001 306-051	2	Rear-stop-indicator-licence plate light, left
2SD 001 306-061	2	Rear-stop-indicator light, right
Spare parts/Accessories:		
9EL 104 571-031	1	Lens with screws, left
9EL 104 571-041	1	right
8GM 002 092-121	10	C5W bulb, 12V
8GM 002 091-121	10	K bulb, 12V

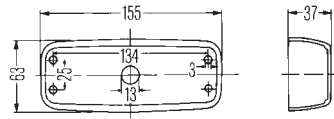
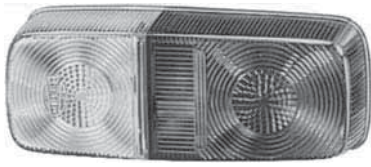

For horizontal or vertical surface mounting

Red rear and stop light, amber indicator light.

Four holes 3 mm dia. for fixing screws.
National type test for Germany.

Part no.	Pk.	
2SD 001 305-021	1	Rear-stop-indicator light
Spare parts/Accessories:		
9EL 052 476-001	1	Lens with screws C5W bulb,
8GM 002 092-121	10	12V
8GM 002 092-241	10	24V
8GM 002 091-121	10	K bulb, 12V
8GM 002 091-241	10	24V

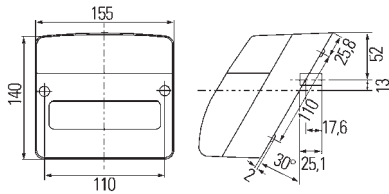

For horizontal surface mounting

Red rear, stop light and reflector, amber indicator light, white licence plate light.

With 12V bulbs.
With plug connector and 4 PT screws KB 40 x 20.

Part no.	Pk.	
2SE 996 030-011	1	Rear-reflector-stop-indicator-licence plate light, left
2SD 996 030-021	1	Rear-reflector-stop-indicator light, right
Spare parts:		
9EL 990 142-001	1	Lens incl. black cover and licence plate window
8GA 002 071-121	10	R5W bulb, 12V
8GA 002 073-121	10	P21W bulb, 12V

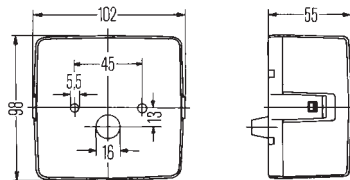

For horizontal or vertical surface mounting

Red rear and stop light, amber indicator light, clear licence plate light.

Lens with snap fastening.
Two holes for M5 fixing screws. With grommet.
Lens for illumination of licence plate can be replaced with red lens included (for use as rear-stop-indicator-light).

Part no.	Pk.	
2SD 004 623-028	1000	Rear-stop-indicator light
2SE 004 623-001	1	Rear-stop-indicator-licence plate light, for 520 x 120 mm, 340 x 240 mm and 240 x 130 mm licence plates (above licence plates)
2SE 004 623-007	50	
Spare parts/Accessories:		
9EL 129 519-001	1	Lens
8GA 002 071-131	10	R10W bulb, 12V
8GA 002 073-121	10	P21W bulb, 12V

For surface mounting

Red rear and stop light, amber indicator light, clear licence plate light.

Two holes for M6 fixing screws. With grommet.
Lens for illumination of licence plate can be replaced with red lens included (for use as rear-stop-indicator light).

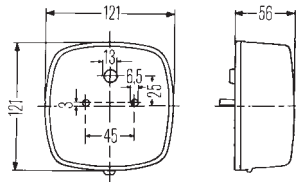

Part no.	Pk.	
2SE 002 578-701	2	Rear-stop-indicator-licence plate light
2SE 002 578-707	18	
Spare parts/Accessories:		
Lens (also suitable for old-type lights of model range 002 578-...)		
9EL 146 491-001	2	R10W bulb,
8GA 002 071-131	10	12V
8GA 002 071-251	10	24V
8GA 002 073-121	10	P21W bulb,
8GA 002 073-241	10	12V
		24V

For horizontal surface mounting

Red rear and stop light, amber indicator light, clear licence plate light.

Steel base plate.
Two M6 fixing screws. With plug connector.
Lens for illumination of licence plate can be replaced with red lens included (for use as rear-stop-indicator light).

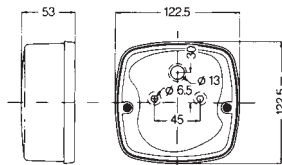

Part no.	Pk.	
2SE 997 008-001	1	Rear-stop-indicator-licence plate light
Spare parts/Accessories:		
9EL 997 332-001	1	Lens
R10W bulb,		
8GA 002 071-131	10	12V
8GA 002 071-251	10	24V
P21W bulb,		
8GA 002 073-121	10	12V
8GA 002 073-241	10	24V

Red rear and stop light, amber indicator light, clear licence plate light.

Black plastic body.
Two M6 fixing screws. With grommet.

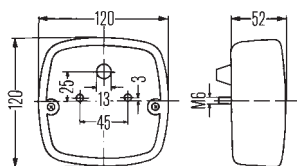

Part no.	Pk.	
2SD 002 514-161	1	Rear-stop-indicator light
2SE 002 514-171	1	Rear-stop-indicator-licence plate light, for 520 x 120 mm, 340 x 240 mm and 240 x 130 mm licence plates
Spare parts/Accessories:		
9EL 119 614-031	2	Lens with screws
R10W bulb,		
8GA 002 071-131	10	12V
8GA 002 071-251	10	24V
P21W bulb,		
8GA 002 071-121	10	12V
8GA 002 071-241	10	24V

For horizontal or vertical surface mounting

Red rear and stop light, amber indicator light.
With illumination for 520 x 120 mm licence plates.
PC lens.

Two 5.5 mm dia. holes for fixing screws.
 With grommet, fixing screws for lens, one clear
 and one red lens for illumination of licence plate provided loose.

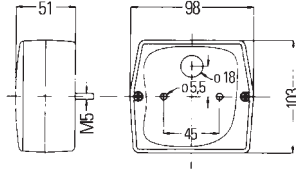

Part no.	Pk.	
2SE 998 530-061	1	Rear-stop-indicator-licence plate light
2SE 998 530-067	108	
Spare parts/Accessories:		
9EL 998 002-031	2	PC lens with screws
8GA 002 073-121	10	P21W bulb, 12V
8GA 002 073-241	10	24V P21/5W bulb,
8GD 002 078-121	10	12V
8GD 002 078-241	10	24V
8GD 002 078-011	10	24V (Heavy Duty)

Universal light mounts

With rear-stop-indicator-licence plate lights.
Can be used at rear of towing vehicles with triple-chamber and dual-chamber (stop/indicator switch-over) light equipment.
When light mounts are attached to vehicles not used for agricultural or forestry applications installation of a rear fog light is necessary for new registration of vehicles.

Cross bar extendable from 1.32 to 2.08 m.
 With 7-pole plug for connection of an additional trailer.



Part no.	Pk.	
Contents:		
		1 cross bar
		2 mounted lights with pre-fitted 12V bulbs
		2 triangular reflectors, red
		1 socket, 7-pole (for additional trailer)
		1 connection lead, 7500 mm long, with 7-pole plug
2XL 004 762-001	1	Universal light mounts
Spare parts/Accessories:		
2SE 004 623-001	1	Rear-stop-indicator-licence plate light
9EL 129 519-001	1	Lens
8RA 002 020-001	25	Reflector, red
8JB 001 943-001	1	7-pole socket
8JA 001 930-001	1	7-pole plug
8GA 002 071-131	10	R10W bulb, 12V
8GA 002 073-121	10	P21W bulb, 12V

For horizontal or vertical surface mounting

In LED-technology. With 12 LEDs and 4-pole DEUTSCH plug connector.
Clear lens.

Rear light: 0.4W, stop light: 1.4W, indicator light: 1.5W at 12V.

Rear light: 0.8W, stop light: 1.8W, indicator light: 1.9W at 24V.

Black plastic body.

Two fixing screws M6.

Consumption:

rear light: 0.03A at 12V, 0.03 at 24V,

stop light: 0.12A at 12V, 0.08A at 24V,

indicator light: 0.13A at 12V, 0.08A at 24V.

See LED instruction 1.

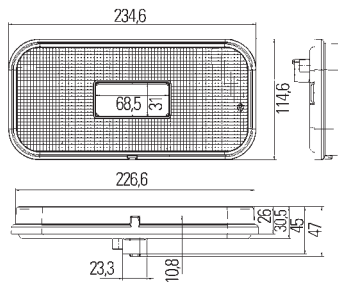

Part no.	Pk.	
2VA 011 900-001	1	Rear-reflector-stop-indicator light with pulse for indicator failure check, 12V
2VA 011 900-021	1	with pulse for indicator failure check, 24V
2VA 011 900-011	1	without pulse for indicator failure check, 12V
2VA 011 900-031	1	without pulse for indicator failure check, 24V
Accessories:		
8KA 197 041-001	1	Connecting lead, 200 mm long, one side with 4-pole DEUTSCH plug, one side with 4-pole Amphenol plug
8KA 197 041-011	1	Connecting lead, 500 mm long, one side with stripped ends, one side with 4 pole Amphenol plug

For surface mounting

In LED-technology. With 8 LEDs. Clear lens, red reflector.
Rear light: 1.0W, stop light: 2.0W, indicator light: 2.0W,
licence plate light: 1.0W.

Black frame with four holes 4.2 mm dia. and two holes 5.0 mm dia. for fixing screws.

Consumption:

rear light: 0.08A at 12V, 0.04A at 24V,

stop light: 0.17A at 12V, 0.08A at 24V,

indicator light: 0.17A at 12V, 0.08A at 24V,

licence plate light: 0.08A at 12V, 0.04A at 24V.

EMC-resistant. Type of protection: IP6K9K and IP6K7.

See LED instruction 1.

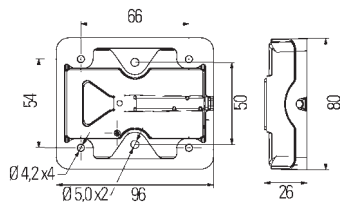

Part no.	Pk.	
		For horizontal or vertical surface mounting. With 500 mm long lead with stripped ends.
2VA 980 720-001	1	Rear-stop-indicator light, 12V/24V
2VA 980 720-007	18	
		For horizontal surface mounting, indicator light above, can be turned 180°. With 150 mm long lead and 4-pole DEUTSCH plug connector.
2VA 980 720-017	15	Rear-stop-indicator light, 12V/24V
		For horizontal surface mounting, indicator light above, can be turned 180°. With 500 mm long lead with stripped ends.
2VB 980 720-401	1	Rear-stop-indicator-licence plate light, 12V/24V
2VB 980 720-407	18	
		For horizontal surface mounting, indicator light below, can be turned 180°. With 500 mm long lead with stripped ends.
2VB 980 720-501	1	Rear-stop-indicator-licence plate light, 12V/24V
2VB 980 720-507	18	
		Accessories:
4JZ 177 846-007	24	Flasher unit, 9V - 33V
8JA 003 526-001	5	Socket, 9-pole

For flush mounting

Red rear, stop light and reflector, amber indicator light.
Rear-stop light bulb-technology convertible to LED-technology,
see accessories.

Black PC/ABS body.

Two holes for M6 fixing screws.

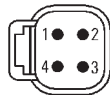
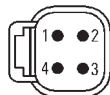
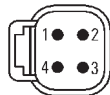
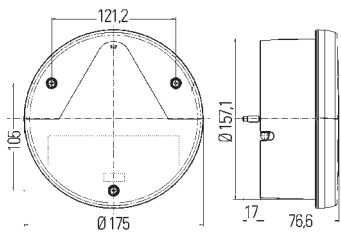
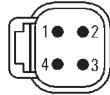
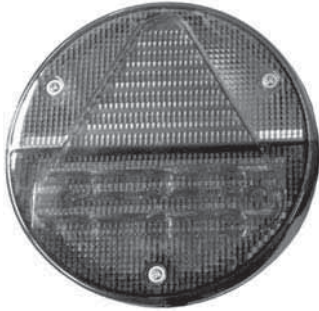

Part no.	Pk.	
2VA 012 497-001	1	Rear-triangular reflector-stop-indicator light with 12V bulbs and 800 mm long lead with blade terminal contacts
2VA 012 497-011	1	with 12V bulbs and 250 mm long lead with 4-pole Amphenol AT plug
2VA 012 497-051	1	with 12V LEDs for rear and stop light, 12V bulb for indicator light and 800 mm long lead with blade terminal contacts
2VA 012 497-061	1	with 12V LEDs for rear and stop light, 12V bulb for indicator light and 250 mm long lead with 4-pole Amphenol AT plug
9EL 209 476-001	1	Spare parts: Lens
8GA 002 073-121	10	P21W bulb, 12V
8GD 002 078-121	10	P21/5W bulb, 12V
9DW 209 487-001	1	LED module, clear, with 6 red LEDs 0.25W for rear-stop light
2VA 012 497-101	1	Rear-reflector-stop-indicator light with 12V bulbs and 800 mm long lead with blade terminal contacts
2VA 012 497-111	1	with 12V bulbs and 250 mm long lead with 4-pole Amphenol AT plug
2VA 012 497-151	1	with 12V LEDs for rear and stop light, 12V bulb for indicator light and 800 mm long lead with blade terminal contacts
2VA 012 497-161	1	with 12V LEDs for rear and stop light, 12V bulb for indicator light and 250 mm long lead with 4-pole Amphenol AT plug
9EL 209 476-011	1	Spare parts/Accessories: Lens
8GA 002 073-121	10	P21W bulb, 12V
8GD 002 078-121	10	P21/5W bulb, 12V
9DW 209 487-001	1	LED module, clear, with 6 red LEDs 0.25W for rear-stop light

For flush or surface mounting

In LED-technology. With 4 LEDs.

Lens red/amber/red with spare part lens clear.

Rear light: 2.0W, stop light: 3.0W, indicator light: 4.0W.

Voltage range: 9V - 32V.

Consumption: 0.75A at 12V, 0.38A at 24V.

Black plastic body.

Light may be installed 2 x per vehicle side.

Type of protection: IP6K9K.

See LED instruction 1.

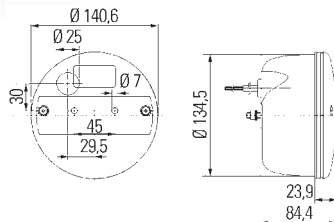
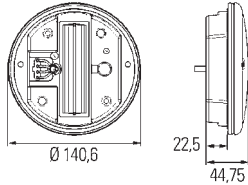
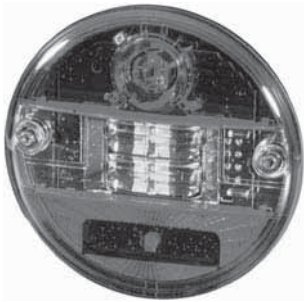

Part no.	Pk.	
2SD 344 100-001	1	Rear-stop-indicator light with two holes for fixing screws ST 4.8 and 500 mm long lead, for flush mounting
2SD 344 100-101	1	without lead, with two M6 x 20 fixing screws, for surface mounting

For flush mounting

Without legal regulations for indicator failure check, with passive electronic. The indicator failure check in the vehicle demanded by law within the scope of ECE has to be ensured. The customer is responsible for this.

In LED-technology. With 42 LEDs.
 Red rear and stop light, amber indicator light.
 Rear light: 0.5W, stop light: 2.0W, indicator light: 3.0W.
 Consumption: 0.23A at 24V.
 Black plastic body.
 Two M6 fixing screws.
 See LED instruction 4.

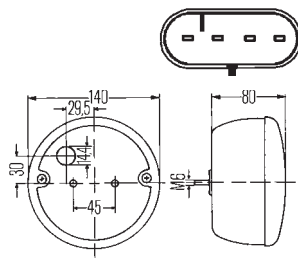

Part no.	Pk.	
2SD 001 685-347	20	Rear-stop-indicator light, 24V, with grommet and 500 mm long lead
2SD 340 685-051	1	with 2000 mm long lead and 4-pole AMP-Superseal plug connector
Accessories:		
4JZ 177 846-007	1	Flasher unit, 9V - 33V, for -347
8JA 003 526-001	5	9-pole socket, for -347
5DS 009 552-031	1	LED indicator control unit, 24V, for -051
8KW 744 808-801	1	Plug-set for -051

For horizontal surface mounting

Red rear and stop light, amber indicator light.
 Black metal body. Two M6 fixing screws.
 With heat-resistant PC lens.
 With vibration damping and grommet.

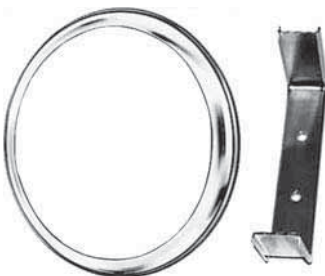
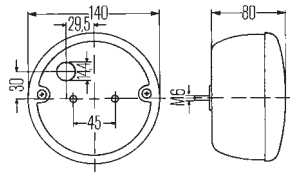

Part no.	Pk.	
2SD 001 685-307	8	Rear-stop-indicator light
Spare parts/Accessories:		
8GA 002 071-121	10	R5W bulb, 12V
8GA 002 071-241	10	24V
8GA 002 071-261	10	24V (Heavy Duty)
P21W bulb,		
8GA 002 073-121	10	12V
8GA 002 073-241	10	24V
8GA 002 073-251	10	24V (Heavy Duty)
9XD 997 909-801	1	Chrome-type mounted frame with mounting bracket for flush mounting

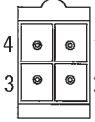

1	red	stop
2	white	ground
3	amber	indicator
4	brown	rear



1	black/red	stop
2	grey	rear
3	brown	ground
4	black/white	indicator



1	amber	indicator
2	grey	stop
3	black	rear
4	white	ground

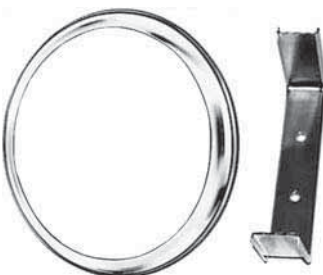
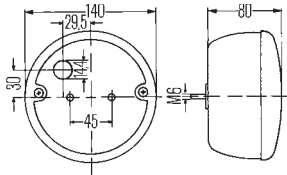

For surface mounting

Red rear and stop light, amber indicator light, clear licence plate light.
Two M6 fixing screws.

Part no.	Pk.		
2SD 001 685-211	1	Rear-stop-indicator light with grommet, without vibration damping and bulbs	
2SD 001 685-218	8		
2SD 001 685-277	48	with 150 mm long lead set, 4-pole plug and 12V bulbs, without grommet	
2SD 001 685-231	1	with vibration damping and grommet, without bulbs	
2SD 001 685-232	8		
2SD 001 685-317	240	with 4-pole AMP plug, 12V bulbs and vibration damping, without grommet	
2SD 001 685-627	30	with 200 mm long lead set, 4-pole DEUTSCH plug connector, 12V bulbs and vibration damping, without grommet (two lights can be fitted next to each other)	
2SE 001 685-201	1	Rear-stop-indicator-licence plate light, for 520 x 120 mm and 340 x 240 mm licence plates, with grommet, without vibration damping and bulbs	
2SE 001 685-221	1	with vibration damping and grommet, without bulbs	
2SE 001 685-227	8		
2SE 001 685-617	30	with 200 mm long lead set, 4-pole DEUTSCH plug connector, 12V bulbs and vibration damping, without grommet (two lights can be fitted next to each other)	
9EL 113 324-001	2	Spare parts: Lens with screws and gasket (except for -317) Bulb holder for -211/-218/-201 R5W bulb, 10 12V 10 24V P21W bulb, 10 12V 10 24V	
9FT 998 007-011	5		
8GA 002 071-121	10		
8GA 002 071-241	10		
8GA 002 073-121	10		
8GA 002 073-241	10		
9XD 997 909-801	1		Chrome-type mounted frame with mounting bracket for flush mounting, for -211/-218/-231/-232

For horizontal surface mounting

Red rear and stop light, amber indicator light, clear licence plate light.

Black plastic body.
Bulb holder with vibration damping.
Two M6 fixing screws.
Only for spare parts requirement.

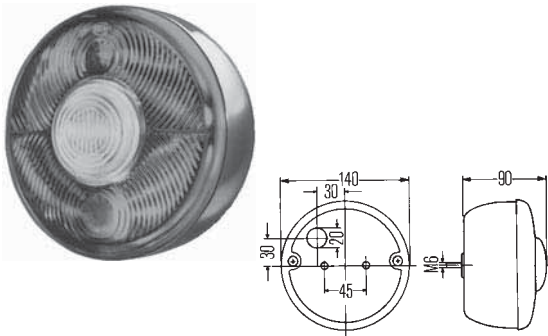

Part no.	Pk.	
2SD 001 686-101	1	Rear-stop-indicator light
2SE 001 686-142	1	Rear-stop-indicator-licence plate light, for 520 x 120 mm, 340 x 240 mm and 240 x 130 mm licence plates
Spare parts/Accessories:		
9EL 102 240-031	2	Lens with screws
8GA 002 071-121	10	12V
8GA 002 071-241	10	24V
8GA 002 073-121	10	12V
8GA 002 073-241	10	24V

Red rear and stop light, amber indicator light.

Black body. Two M6 fixing screws.
National type test for Germany

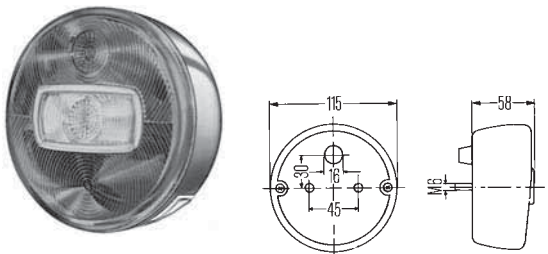

Part no.	Pk.	
2SD 001 679-001	1	Rear-stop-indicator light
2SE 001 679-051	1	Rear-stop-indicator-licence plate light, for 520 x 120 mm, 340 x 240 mm and 240 x 130 mm licence plates
Spare parts/Accessories:		
9EL 126 294-001	2	Lens with screws
8GM 002 091-131	10	12V10W
8GM 002 091-121	10	12V18W

Red rear light, amber stop-(indicator) light.

Black body. Two M6 fixing screws. With grommet.
Only for spare parts requirement.
National type test for Germany.

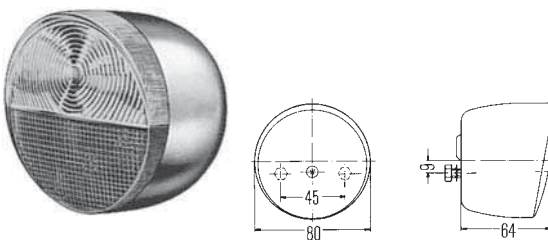

Part no.	Pk.	
2SB 001 301-021	2	Rear-stop-(indicator) light
Spare parts/Accessories:		
8GM 002 091-131	10	12V10W
8GM 002 091-121	10	12V18W

Red rear light, amber stop-(indicator) light.

Black body. Two M6 fixing screws. With grommet.
Only for spare parts requirement.
National type test for Germany.

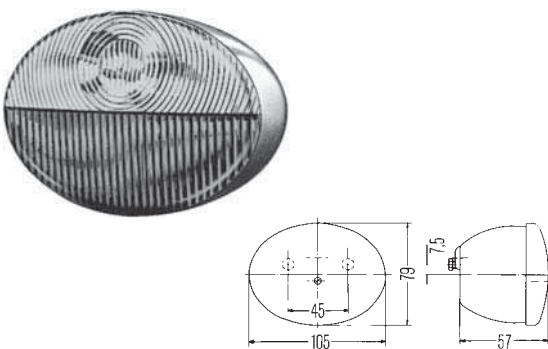

Part no.	Pk.	
2SB 001 673-002	1	Rear-stop-(indicator) light
2ST 001 673-011	1	Rear-stop-(indicator)-licence plate light, for 340 x 240 mm licence plates with 0°, 25° and 30° inclination or 240 x 130 mm with 0°- 30° inclination
Spare parts/Accessories:		
8GA 002 071-131	10	R10W bulb, 12V
8GA 002 072-121	10	R bulb, 12V

Combinable lights

959 037 - 980 710 series

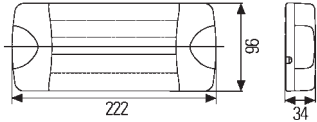

1	rear
2	stop
3	indicator
4	reverse
5	ground

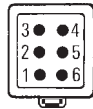

For horizontal surface mounting

DuraLED Combi

In LED-technology. With 30 LEDs.
With clear lens and metallic grey ends.
Rear light: 1.0W, stop light: 5.0W, indicator light: 4.0W,
reverse light: 3.0W.

Black plastic body. Two 6.2 mm dia. holes for fixing screws.
 Consumption: 1.1A at 12V, 0.55A at 24V.
 Voltage range: 12V - 24V.
 Type of protection 2SK 980 603-503: IP6K6 and IP6K7.
 Type of protection 2SK 980 615-001: IP6K7 and IP6K9K.
 See LED instruction 1.

Part no.	Pk.	
2SK 980 603-503	1	Rear-stop-indicator-reverse light with 2500 mm long lead with stripped ends
2SK 980 615-001	1	with 6-pole DEUTSCH plug connector

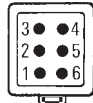
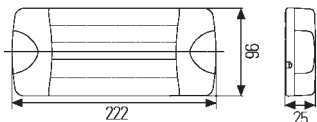

In LED-technology. With 18 LEDs 24V and polarity reversal protection.
With clear Grilamid lens and metallic grey ends.
Rear-stop light: 4.0W, indicator light: 3.0W,
reverse light: 3.0W.

Black plastic body.
 Two 6.2 mm dia. holes for fixing screws.
 Consumption: 0.4A.
 Type of protection: IP6K7, IP6K9K.
 See LED instruction 1.

Part no.	Pk.	
2SK 980 613-501	1	Rear-stop-indicator-reverse light with 2500 mm long, potted lead with stripped ends
2SK 980 602-501	1	with 6-pole DEUTSCH plug connector

For horizontal or vertical surface mounting

In LED-technology. With 40 LEDs and 2500 mm long lead with stripped ends.
Clear lens, red ends.
Rear light: 1.5W, stop light: 5.0W, indicator light: 3.0W.

Black plastic body.
 Two 6.2 mm dia. holes for fixing screws.
 Voltage range: 8V - 28V.
 Consumption: 0.92A at 12V, 0.46A at 24V.
 Type of protection: IP6K7 and IP6K9K.
 See LED instruction 1.

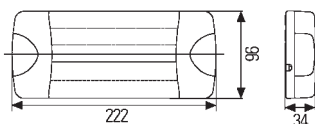
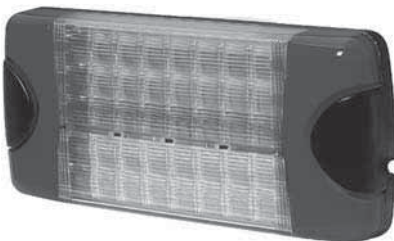

Part no.	Pk.	
2SD 959 050-401	1	Rear-stop-indicator light with pulse for indicator failure check



For horizontal or vertical surface mounting

DuraLED Combi

In LED-technology. With 30 LEDs.
With clear Grilamid lens and red ends.
Rear light: 1.0W, stop light: 5.0W, indicator light: 5.0W.

Black body.
Two 6.2 mm dia. holes for fixing screws.
Voltage range: 12V - 24V.
Consumption: 0.92A at 12V, 0.46A at 24V.
Type of protection: IP6K7, IP6K9K. See LED instruction 1.

1	rear
2	stop
3	indicator
4	indicator
5	ground
6	position

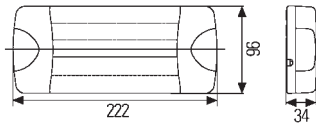
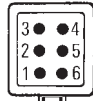

Part no.	Pk.	
2SD 980 602-211	1	Rear-stop-indicator light with pulse for indicator failure check and 6-pole DEUTSCH plug
2SD 980 613-211	1	with pulse for indicator failure check and 2500 mm connecting lead

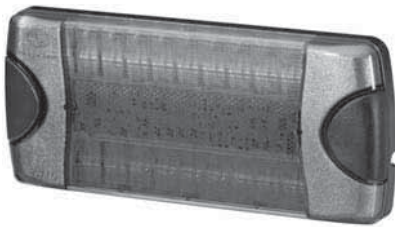

For horizontal surface mounting

In LED-technology. With 16 red LEDs and 2500 mm connecting lead with stripped ends.
With red/amber Grilamid lens and metallic grey ends.
Rear light: 1.0W, stop light: 4.0W, indicator light: 4.0W.

Black plastic body.
Two 6.2 mm dia. holes for fixing screws.
Consumption: 0.92A at 12V, 0.46A at 24V.
Type of protection: IP6K7, IP6K9K.
See LED instruction 1.

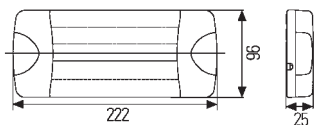

Part no.	Pk.	
2VA 980 710-061	1	Rear-reflector-stop-indicator light without pulse for indicator failure check, 12V / 24V
2VA 980 710-301	1	with pulse for indicator failure check, 24V



For surface mounting

DuraLED

In LED-technology. Clear lens.
With 24 red LEDs and 2500 mm long lead with stripped ends.
Rear light: 2.5W, stop light: 6.0W.

Black body. Voltage range: 9V - 33V.
Consumption:
rear light: 0.21A at 12V, 0.11A at 24V,
stop light: 0.5A at 12V, 0.25A at 24V.
Type of protection: IP6K6 and IP6K7.
See LED instruction 2.

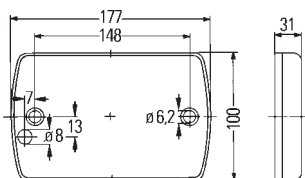

Part no.	Pk.	
2SB 980 606-201	1	Rear-stop light for horizontal mounting
2SB 980 606-701	1	for vertical mounting

Combinable lights

959 037 - 980 710 series

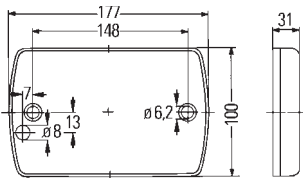

For rear mounting (category 2a)

DuraLED

In LED-technology. Clear lens.
With 24 amber LEDs 4.0W and 2500 mm long lead with stripped ends.

Black body. Voltage range: 9V - 33V.
 Consumption: 0.34A at 12V, 0.17A at 24V.
 Type of protection: IP6K6, IP6K7.
 See LED instruction 3.

Part no.	Pk.	
2BA 980 607-201	1	Indicator light for horizontal mounting
2BA 980 607-701	1	for vertical mounting

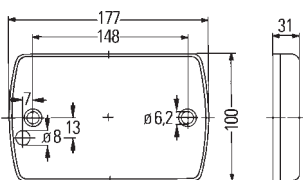

For surface mounting

In LED-technology. Clear lens.
With 24 white LEDs 4.0W and 2500 mm long lead with stripped ends.

Black body. Voltage range: 9V - 33V.
 Consumption: 0.34A at 12V, 0.17A at 24V.
 Type of protection: IP6K6, IP6K7.
 See LED instruction 3.

Part no.	Pk.	
2ZR 980 605-201	1	Reverse light for horizontal mounting
2ZR 980 605-701	1	for vertical mounting

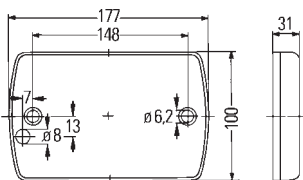

In LED-technology. Clear lens.
With 36 white LEDs 9.0W and 2500 mm connecting lead with stripped ends.

Black body. Voltage range: 9V - 33V.
 Consumption: 0.75A at 12V, 0.38A at 24V.

Part no.	Pk.	
2JA 959 037-511	1	Interior light

For horizontal surface mounting

Lens with snap fastening.
Two 5.5 mm dia. holes for fixing screws.

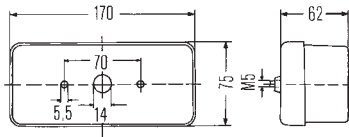

Part no.	Pk.	
		Red rear and stop light, amber indicator light.
2SD 002 582-011	1	Rear-stop-indicator light, left
2SD 002 582-017	32	
2SD 002 582-021	1	Rear-stop-indicator light, right
2SD 002 582-027	32	
		Spare parts:
9EL 112 743-001	1	Lens with divider, left
9EL 112 741-001	1	right
8GA 002 071-131	10	R10W bulb, 12V
8GA 002 071-251	10	24V
8GA 002 073-121	10	P21W bulb, 12V
8GA 002 073-241	10	24V
		Red rear and stop light, amber indicator light. with illumination for 520 x 120 mm and 340 x 240 mm licence plates.
2SE 002 582-071	1	Rear-stop-indicator-licence plate light, left
		Spare parts/Accessories:
9EL 116 844-001	1	Lens with divider, left
8GA 002 071-131	10	R10W bulb, 12V
8GA 002 071-251	10	24V
8GA 002 073-121	10	P21W bulb, 12V
8GA 002 073-241	10	24V
		For front mounting. Amber indicator light, clear position light.
2BE 002 582-031	1	Indicator-position light
		Spare parts/Accessories:
9EL 112 744-001	1	Lens with divider
8GA 002 071-121	10	R5W bulb, 12V
8GA 002 071-241	10	24V
8GA 002 073-121	10	P21W bulb, 12V
8GA 002 073-241	10	24V

Combinable lights

003 184 series



For horizontal surface mounting

Two B3.9 x 16 fixing screws. With grommet.

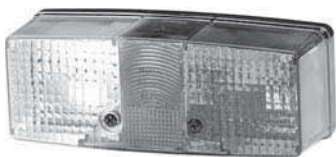
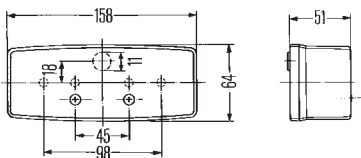
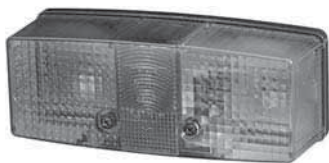

Part no.	Pk.	
		Red rear and stop light, amber indicator light.
2SD 003 184-031	1	Rear-stop-indicator light, left
2SD 003 184-037	45	
2SD 003 184-041	1	Rear-stop-indicator light, right
2SD 003 184-047	45	
		Spare parts:
		Lens with screws,
9EL 118 700-001	1	left
9EL 118 701-001	1	right
		Red rear and stop light, amber indicator light, clear licence plate light, for 340 x 240 mm licence plates.
2SE 003 184-011	1	Rear-stop-indicator-licence plate light, left
2SE 003 184-017	45	
2SE 003 184-101	1	Rear-stop-indicator-licence plate light, right
		Spare parts/Accessories:
		Lens with screws,
9EL 118 697-001	1	left
9EL 121 431-001	1	right
8GA 002 071-131	10	12V
8GA 002 071-251	10	24V
8GA 002 073-121	10	P21W bulb,
8GA 002 073-241	10	12V
8GA 002 073-241	10	24V
8RA 123 251-005	50	Reflectors
9XD 132 749-005	8	Adapter
		For front mounting.
		Amber indicator light, clear position light.
2BE 003 184-051	1	Indicator-position light, left
2BE 003 184-061	1	Indicator-position light, right
		Spare parts/Accessories:
		Lens with screws,
9EL 118 703-001	1	left
9EL 118 705-001	1	right
8GA 002 071-121	10	R5W bulb,
8GA 002 071-241	10	12V
8GA 002 071-241	10	24V
8GA 002 073-121	10	P21W bulb,
8GA 002 073-121	10	12V
8GA 002 073-241	10	24V

For horizontal surface mounting

Black plastic body.
Two M5 fixing screws.

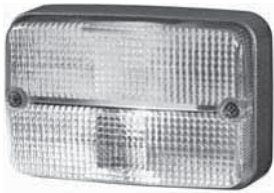
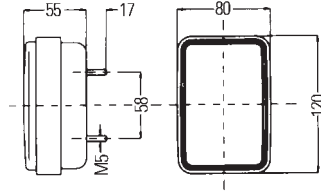
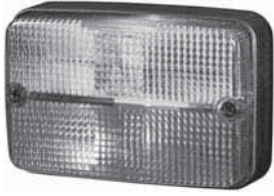

Part no.	Pk.	
		Red rear and stop light, amber indicator light.
2SD 997 131-051	1	Rear-stop-indicator light with blade terminal contacts
2SD 997 131-367	30	Rear-stop-indicator light with 900 mm long lead and 4-pole DEUTSCH plug connector
		Spare parts/Accessories:
9EL 997 469-001	2	Lens
8GA 002 073-121	10	P21W bulb, 12V
8GD 002 078-121	10	P21/5W bulb, 12V
		For front mounting. Amber indicator light, clear position light.
2BE 997 131-081	1	Indicator-position light without blade terminal contacts
2BE 997 131-207	1	Indicator-position light with blade terminal contacts
		Spare parts/Accessories:
9EL 997 459-001	2	Lens
8GA 002 073-121	10	P21W bulb, 12V
8GA 002 071-121	10	R5W bulb, 12V

Combinable lights

997 006 series



For horizontal surface mounting

Steel base plate. Two M6 fixing screws.

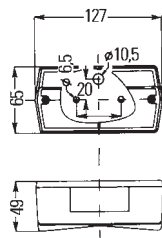

Part no.	Pk.	
		Red rear and stop light, amber indicator light.
2SD 997 006-031	1	Rear-stop-indicator light, left
2SD 997 006-021	1	Rear-stop-indicator light, right
		Accessories:
8GA 002 073-121	10	P21W bulb, 12V
8GA 002 073-241	10	24V
8GM 002 092-121	10	C5W bulb, 12V
8GM 002 092-241	10	24V
		Red rear and stop light, amber indicator light, clear licence plate light.
2SE 997 006-011	1	Rear-stop-indicator-licence plate light, left
		Spare parts/Accessories:
8GA 002 073-121	10	P21W bulb, 12V
8GA 002 073-241	10	24V
8GM 002 092-121	10	C5W bulb, 12V
8GM 002 092-241	10	24V
		For front mounting.
		Amber indicator light, clear position light. With plug connector.
2BE 997 006-101	1	Indicator-position light
		Spare parts/Accessories:
8GA 002 071-121	10	R5W bulb, 12V
8GA 002 071-241	10	24V
8GA 002 073-121	10	P21W bulb, 12V
8GA 002 073-241	10	24V

For horizontal or vertical surface mounting

Red rear and stop light, amber indicator light, clear licence plate light.

Lens with snap fastening.

Two holes for M5 fixing screws. With grommet.

Only for spare parts requirement.

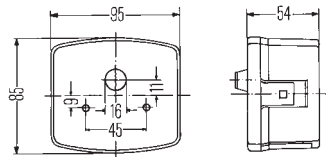

Part no.	Pk.	
2SD 003 182-051	1	Rear-stop-indicator light, left
2SD 003 182-057	120	
2SD 003 182-061	1	right
2SD 003 182-067	120	
Spare parts:		
9EL 118 614-011	2	Lens
8GA 002 071-131	10	R10W bulb, 12V
8GA 002 071-251	10	24V
8GA 002 073-121	10	P21W bulb, 12V
8GA 002 073-241	10	24V
Rear-stop-indicator-licence plate light, for 520 x 120 mm, 340 x 240 mm and 240 x 130 mm licence plates (above licence plates), or mounting to left and right of 520 x 120 mm licence plate, left		
2SE 003 182-011	1	right
2SE 003 182-017	120	
2SE 003 182-021	1	right
2SE 003 182-027	120	
Spare parts/Accessories:		
9EL 118 613-001	2	Lens
8GA 002 071-131	10	R10W bulb, 12V
8GA 002 071-251	10	24V
8GA 002 073-121	10	P21W bulb, 12V
8GA 002 073-241	10	24V

Amber indicator light, white position light.

Lens with snap fastening.

Two holes for M5 fixing screws. With grommet.

Only for spare parts requirement.

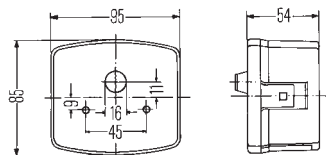

Part no.	Pk.	
2BE 003 182-091	1	Indicator-position light, left
2BE 003 182-101	1	
Spare parts/Accessories:		
9EL 118 614-021	2	Lens
8GA 002 073-121	10	P21W bulb, 12V
8GA 002 073-241	10	24V
8GM 002 092-121	10	C5W bulb, 12V
8GM 002 092-241	10	24V

For horizontal or vertical surface mounting

Red rear and stop light, amber indicator light, clear licence plate light.

Lens with snap fastening.

Two holes for M5 fixing screws. With grommet.

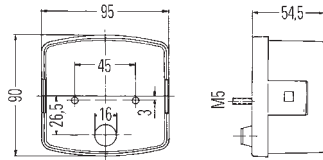

Part no.	Pk.	
2SD 002 776-231	1	Rear-stop-indicator light, left
2SD 002 776-237	110	
2SD 002 776-241	1	right
2SD 002 776-247	110	
Spare parts:		
Lens with heat dissipation plate,		
9EL 137 307-001	2	left
9EL 137 308-001	2	right
8GA 002 071-131	10	R10W bulb, 12V
8GA 002 073-121	10	P21W bulb, 12V
Rear-stop-indicator-licence plate light, for 520 x 120 mm, 340 x 240 mm and 240 x 130 mm licence plates (above licence plates), or mounting to left and right of 520 x 120 mm licence plate (amber flasher light at the top), left		
2SE 002 776-211	1	
2SE 002 776-217	110	
2SE 002 776-221	1	right
Spare parts/Accessories:		
Lens,		
9EL 134 739-001	2	left
9EL 134 740-001	2	right
8GA 002 071-131	10	R10W bulb, 12V
8GA 002 073-121	10	P21W bulb, 12V

Amber indicator light, white position light.

Lens with snap fastening.

Two holes for M5 fixing screws. With grommet.

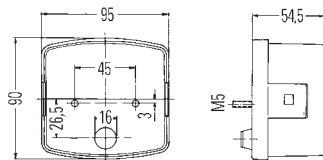

Part no.	Pk.	
2BE 002 776-251	1	Indicator-position light, left
2BE 002 776-257	72	
2BE 002 776-261	1	right
2BE 002 776-267	72	
Spare parts/Accessories:		
Lens,		
9EL 134 741-021	2	left
9EL 134 742-021	2	right
8GA 002 071-131	10	R10W bulb, 12V
8GA 002 073-121	10	P21W bulb, 12V

For horizontal surface mounting

Two 5.2 mm dia. holes for fixing screws.

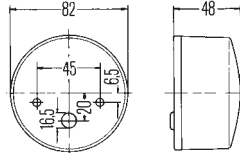
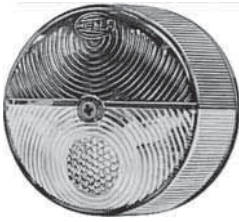

Part no.	Pk.	
		Red rear light, amber indicator light. Only for spare parts requirement.
2SW 003 185-041	1	Rear-indicator light
2SW 003 185-047	33	
		Spare parts:
9EL 118 633-001	4	Lens with screw
8GM 002 092-121	10	C5W bulb, 12V
8GA 002 073-121	10	P21W bulb, 12V
		For front mounting. Amber indicator light, white position light.
2BE 003 185-031	1	Indicator-position light
		Spare parts/Accessories:
9EL 119 397-001	4	Lens with screw
		C5W bulb,
8GM 002 092-121	10	12V
8GM 002 092-241	10	24V
		P21W bulb,
8GA 002 073-121	10	12V
8GA 002 073-241	10	24V

Black body. Two M6 fixing screws. With grommet.
Only for spare parts requirement.
National type test for Germany.

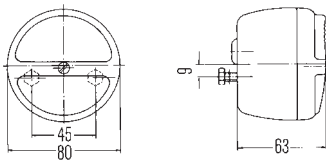

Part no.	Pk.	
		For horizontal surface mounting. Red rear light, amber stop-(indicator) light, white licence plate light.
2SB 003 018-031	1	Rear-stop-(indicator) light
		Rear-stop-(indicator)-licence plate light, for 520 x 120 mm, 340 x 240 mm and 240 x 130 mm licence plates with 0°-20° inclination
2ST 003 018-061	1	
		Spare parts/Accessories:
9EL 089 114-001	2	Lens with rim and screw
		K bulb,
8GM 002 091-131	10	12V10W
8GM 002 091-121	10	12V18W
		For front mounting. Amber indicator light, clear position light.
2BE 003 018-011	1	Indicator-position light
		Accessories:
8GM 002 091-121	10	K bulb, 12V
8GM 002 092-121	10	C5W bulb, 12V

Combinable lights

008 405 series



For flush or surface mounting

In LED-technology. Clear lens.

For lights in model range 008 221-..., 011 172-...

When the ring 008 405-... is mounted in an assembly with the lights 008 221-..., the heat deflector shield has to be used (to be ordered separately). Use of the heat defelctor shield is required at an ambient temperature of > 50 °C.

See LED instruction 2.

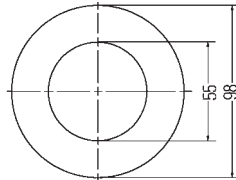

Part no.	Pk.	
		With 12 red LEDs 1.8W. Consumption: 0.15A at 12V, 0.08A at 24V.
2SA 008 405-021	1	Rear light, 12V
2SA 008 405-027	60	
2SA 008 405-011	1	Rear light, 24V
2SA 008 405-017	60	
		With 12 red LEDs 2.1W. Consumption: 0.18A at 12V, 0.09A at 24V.
2SB 008 405-101	1	Rear-stop light, 12V
2SB 008 405-091	1	Rear-stop light, 24V
		For front flush/surface mounting. With 12 white LEDs 1.8W. Consumption: 0.15A at 12V, 0.08A at 24V.
2PF 008 405-061	1	Position light, 12V
2PF 008 405-067	60	
2PF 008 405-051	1	Position light, 24V
2PF 008 405-057	60	
2PF 008 405-127	60	Position light with 200 mm long connecting lead and 2-pole DEUTSCH plug connector, 24V
9XB 161 749-007	75	Accessories: Heat deflector shield
8RA 008 405-001	1	Reflector red, with additional clear lens
8RA 008 405-007	60	

To fit 90 mm dia. headlights

For flush mounting

In LED-technology. Clear lens with optical pattern.

Type of protection: IP6K9K. See LED instruction 2.

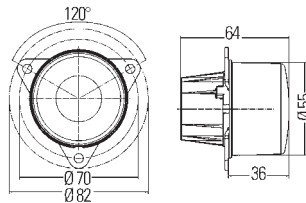

Part no.	Pk.	
		Red light. With 6 LEDs and 500 mm long lead. Consumption: 0.03A at 12V, 0.008A at 24V.
2SA 011 172-041	1	Rear light, 12V0.3W
2SA 011 172-047	20	
2SA 011 172-441	1	Rear light, 24V0.2W
2SA 011 172-447	20	
		Red light. With 6 LEDs and 500 mm long lead. Consumption: 0.08A at 12V, 0.03A at 24V.
2DA 011 172-061	1	Stop light, 12V0.9W
2DA 011 172-067	20	
2DA 011 172-461	1	Stop light, 24V0.7W
2DA 011 172-467	20	
		Red light. With 6 LEDs and 500 mm long lead. Consumption: 0.21A at 12V, 0.08A at 24V.
2NE 011 172-081	1	Rear fog light, 12V2.5W
2NE 011 172-087	20	
2NE 011 172-481	1	Rear fog light, 24V1.9W
2NE 011 172-487	20	
		Amber light. With 3 LEDs and 500 mm long lead. Consumption: 0.04A at 12V, 0.02A at 24V.
2BA 011 172-001	1	Indicator light for flush mounting, 12V4.8W
2BA 011 172-007	20	
2BA 011 172-401	1	Indicator light for flush mounting, 24V4.8W
2BA 011 172-407	20	
2BA 011 172-011	1	Indicator light with failure check for flush mounting, 12V4.8W
2BA 011 172-017	20	
2BA 011 172-411	1	Indicator light with failure check for flush mounting, 24V4.8W
2BA 011 172-417	20	
		Amber light. With 3 LEDs and 140 mm long lead. Consumption: 0.04A at 12V, 0.02A at 24V.
2BA 011 172-147	180	Indicator light with failure check for flush mounting, 12V4.8W
		Amber light. With 6 LEDs and 500 mm long lead. Consumption: 0.09A at 12V, 0.03A at 24V.
2BA 011 172-021	1	Indicator light for rear flush mounting, 12V1.1W
2BA 011 172-027	20	
2BA 011 172-421	1	Indicator light for rear flush mounting, 24V0.8W
2BA 011 172-427	20	
2BA 011 172-031	1	Indicator light with failure check for rear flush mounting, 12V1.1W
2BA 011 172-037	20	
2BA 011 172-431	1	Indicator light with failure check for rear flush mounting, 24V0.8W
2BA 011 172-437	20	
		Accessories:
8XU 008 405-031	1	Decorative moulding (illustration similar to reflector)
8XU 008 405-037	60	

To fit 90 mm dia. headlights

Combinable lights

011 172 series



For flush mounting

In LED-technology. Clear lens with optical pattern.

Type of protection: IP6K9K. See LED instruction 2.

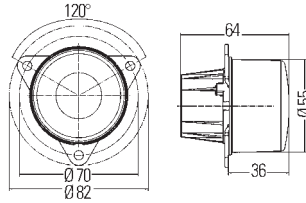

Part no.	Pk.	
2PF 011 172-157	180	White light. With 6 LEDs and 140 mm long lead. Consumption: 0.08A at 12V, 0.07A at 24V.
		Position light for front flush mounting, 12V1.0W
2PF 011 172-111 2PF 011 172-117	1	White light. With 6 LEDs and 500 mm long lead. Consumption: 0.08A at 12V, 0.07A at 24V.
	20	Position light for front flush mounting, 12V1.0W
2PF 011 172-511 2PF 011 172-517	1	Position light for front flush mounting, 24V1.7W
	20	
2ZR 011 172-101 2ZR 011 172-107	1	White light. With 6 LEDs and 500 mm long lead. Consumption: 0.21A at 12V, 0.05A at 24V.
	20	Reverse light, 12V2.5W
2ZR 011 172-501 2ZR 011 172-507	1	Reverse light, 24V1.1W
	20	
8XU 008 405-031 8XU 008 405-037	1	Accessories: Decorative moulding (illustration similar to reflector)
	60	

To fit 90 mm dia. headlights

For flush mounting

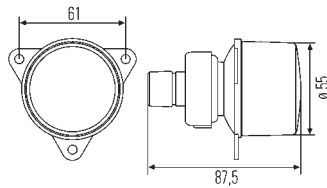

Part no.	Pk.	
2XA 008 221-021 2XA 008 221-027	1 20	Signal light with red lens, optional use as rear light (R5W) or stop light (P21W)
2SA 008 221-127	20	Rear light with red lens and 12V5W bulb
2DA 008 221-167	20	Stop light with red lens and 12V21W bulb
		Spare parts/Accessories:
8GA 002 071-121	10	R5W bulb, 12V
8GA 002 071-241	10	24V
8GA 002 073-121	10	P21W bulb, 12V
8GA 002 073-241	10	24V
8KA 152 134-007	20	Lead with grommet, 500 mm long
8XU 008 405-031	1	Decorative moulding (illustration similar to reflector)
8XU 008 405-037	60	
9GT 137 236-007	20	Grommet
2NE 008 221-031 2NE 008 221-037	1 20	Rear fog light with red lens, without bulb
2NE 008 221-137	20	with 12V bulb
		Spare parts/Accessories:
8GA 002 073-121	10	P21W bulb, 12V
8GA 002 073-241	10	24V
8KA 152 134-007	20	Lead with grommet, 500 mm long
8XU 008 405-031	1	Decorative moulding (illustration similar to reflector)
8XU 008 405-037	60	
9GT 137 236-007	20	Grommet
2BA 008 221-001 2BA 008 221-007	1 20	Indicator light for front flush mounting with clear lens, without bulb
2BA 008 221-107 2BA 008 221-217	20 20	with amber 12V bulb with amber 24V HD bulb
2BA 008 221-041 2BA 008 221-047	1 20	Indicator light for rear flush mounting, with grey lens, without bulb
2BA 008 221-147	20	with amber 12V bulb
		Spare parts/Accessories:
8GA 006 841-121	10	PY21W bulb, 12V
8GA 006 841-241	10	24V
8GA 006 841-251	10	24V (HD)
8KA 152 134-007	20	Lead with grommet, 500 mm long
8XU 008 405-031	1	Decorative moulding (illustration similar to reflector)
8XU 008 405-037	60	
9GT 137 236-007	20	Grommet

To fit 90 mm dia. headlights

Combinable lights

008 221 series



For flush mounting

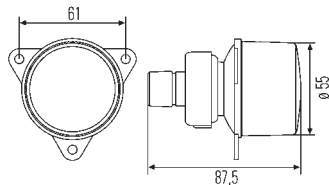

Part no.	Pk.	
2PF 008 221-011	1	Position light for front flush mounting, with clear lens, without bulb
2PF 008 221-017	20	
2PF 008 221-177	20	with 12V bulb
		Spare parts/Accessories:
8GA 002 071-121	10	R5W bulb, 12V
8GA 002 071-241	10	24V
8KA 152 134-007	20	Lead with grommet, 500 mm long
8XU 008 405-031	1	Decorative moulding (illustration similar to reflector)
8XU 008 405-037	60	
9GT 137 236-007	20	Grommet
		Reverse light with grey lens, without bulb
2ZR 008 221-051	1	
2ZR 008 221-057	20	
2ZR 008 221-157	20	with 12V bulb
		Spare parts/Accessories:
8GA 002 073-121	10	P21W bulb, 12V
8GA 002 073-241	10	24V
8KA 152 134-007	20	Lead with grommet, 500 mm long
8XU 008 405-031	1	Decorative moulding (illustration similar to reflector)
8XU 008 405-037	60	
9GT 137 236-007	20	Grommet

To fit 90 mm dia. headlights

For flush mounting

In LED-technology. With 16 LEDs and 250 mm long lead.
Red rear and stop light.

Consumption: 0.29A at 12V/24V.

For lights in model range 009 001-...

See LED instruction 2.

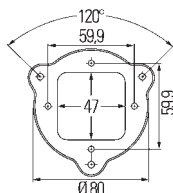
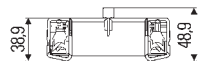
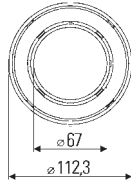
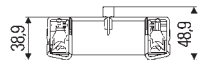
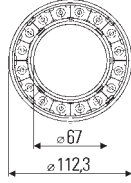

Part no.	Pk.	Description
2SB 009 362-021	1	Rear-stop light with clear lens, 12V2.4W
2SB 009 362-041	1	Rear-stop light with red lens, 12V2.4W
2SB 009 362-067	20	with 3 pole AMP plug connector and red lens, 12V2.4W
2SB 009 362-011	1	with red lens, 24V4.8W
8RA 009 362-001	1	Reflector, red
8XU 009 362-101	1	Accessories: Design rim, red
8XU 009 362-111	1	clear
9HB 163 085-001	1	Design rim for 2SB/8XU 009 362-..., silver coloured
9HB 163 085-012	1	chrome coloured
9XD 161 119-017	30	Adapter rim for rear-stop lights and for mounting of reflector

Combinable lights

009 362 / 009 001 series



For flush mounting

In LED-technology. With 30 LEDs and 250 mm long lead with 3-pole AMP Superseal plug connector.
Red rear and stop light.

Consumption
rear and stop light: 0,03A at 12V,
rear light: 0,04A, stop light: 0,13A at 24V.
For lights in model range 009 001-...
See LED instruction 2.

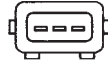
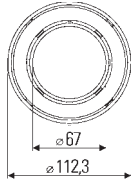

Part no.	Pk.	
2SB 009 362-311	1	Rear-stop light with clear lens, 12V3,5W
2SB 009 362-331	1	with clear lens, 24V3,8W
2SB 009 362-301	1	Rear-stop light with red lens, 12V3,5W
2SB 009 362-321	1	with red lens, 24V3,8W
8RA 009 362-001	1	Reflector, red
8XU 009 362-101	1	Accessories: Design rim, red
8XU 009 362-111	1	clear
9HB 163 085-001	1	Design rim for 2SB/8XU 009 362-..., silver coloured
9HB 163 085-012	1	chrome coloured
9XD 161 119-017	30	Adapter rim for rear-stop lights and for mounting of reflector

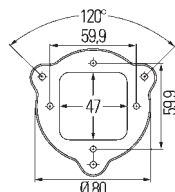
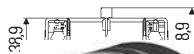
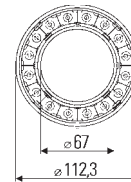
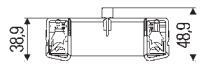

For flush mounting

In LED-technology. Clear lens. With AMP plug.

Recommended fixing screw M4 x 12 by Ejot, torque 2 Nm.

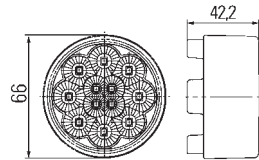

Part no.	Pk.	
		With 12 red Power LEDs. Rear light: 0.5W, stop light: 2.5W. Consumption: 0.25A at 12V, 0.13A at 24V. See LED instruction 2.
2SB 009 001-401	1	Rear-stop light, 12V
2SB 009 001-501	1	Rear-stop light, 24V
8JD 162 581-802	1	Accessories: AMP plug-set, 3-pole (Contents: 20 pieces)
		For rear mounting. With 12 amber Power LEDs, 2.4W. Consumption: 0.2A at 12V, 0.1A at 24V. See LED instruction 3, 4.
2BA 009 001-411	1	Indicator light without failure check, 12V
2BA 009 001-511	1	Indicator light without failure check, 24V
2BA 009 001-431	1	Indicator light with failure check, 12V
2BA 009 001-531	1	Indicator light with failure check, 24V
8JD 156 150-807	1	Accessories: Delphi plug-set, 2-pole (Contents: 20 pieces)
		For front mounting. With 12 white Power LEDs, 1.8W. Consumption: 0.15A at 12V, 0.08A at 24V. See LED instruction 2.
2PF 009 001-421	1	Position light, 12V
2PF 009 001-521	1	Position light, 24V
8JD 156 150-807	1	Accessories: Delphi plug-set, 2-pole (Contents: 20 pieces)

Combinable lights

009 001 series



For flush or surface mounting

In LED-technology. Rear-stop light with 16 LEDs 2.4W, indicator light with 12 amber Power LEDs 2.4W. Rear-stop light with lead and 3-pole AMP plug connector, indicator light with failure check and 2-pole AMP plug connector. Lens for rear-stop light red, indicator light clear.

Recommended fixing screw M4 x 12 by Ejot, torque 2 Nm.

Consumption: 0.2A at 12V.

See LED instruction 2, 3.

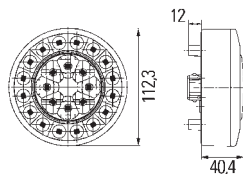

Part no.	Pk.	
2SD 010 546-127	24	Rear-stop-indicator light without design ring, 12V
2SD 010 546-137	24	with silver coloured design ring, 12V
8JD 156 150-807	1	Accessories: Plug-set, 2-pole
8JD 162 581-802	1	3-pole

For flush mounting

With bulb and AMP plug.

Lens without optical pattern with body bonded, with reflector.
Recommended fixing screw M4 x 12 by Ejot,
torque 2 Nm.

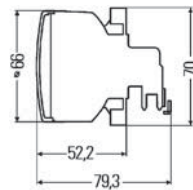

Part no.	Pk.	
2SA 009 001-137	60	Red lens.
		Rear light, 24V
		Spare parts/Accessories:
8GD 002 078-121	10	P21/5W bulb, 12V
8GD 002 078-241	10	24V
8JD 162 581-802	1	AMP plug-set, 3-pole (Contents: 20 pieces)
<hr/>		
		Red lens.
2SB 009 001-061	1	Rear-stop light, 12V
2SB 009 001-067	60	
2SB 009 001-157	60	Rear-stop light, 24V
		Spare parts/Accessories:
8GD 002 078-121	10	P21/5W bulb, 12V
8GD 002 078-241	10	24V
8JD 162 581-802	1	AMP plug-set, 3-pole (Contents: 20 pieces)
<hr/>		
		Red lens.
2DA 009 001-051	1	Stop light, 12V
2DA 009 001-057	60	
2DA 009 001-147	60	Stop light, 24V
		Spare parts/Accessories:
8GA 002 073-121	10	P21W bulb, 12V
8GA 002 073-241	10	24V
8JD 156 150-807	1	Delphi plug-set, 2-pole (Contents: 20 pieces)
<hr/>		
		Red lens.
2NE 009 001-021	1	Rear fog light, 12V
2NE 009 001-027	60	
2NE 009 001-127	60	Rear fog light, 24V
		Spare parts/Accessories:
8GH 008 417-001	1	H21W bulb, 12V
8GH 008 417-012	10	24V
8JD 156 150-807	1	Delphi plug-set, 2-pole (Contents: 20 pieces)
<hr/>		
		For front mounting.
		Clear lens.
2PF 009 001-081	1	Position light, 12V
2PF 009 001-177	60	Position light, 24V
		Spare parts/Accessories:
8GD 002 078-121	10	P21/5W bulb, 12V
8GD 002 078-241	10	24V
8JD 162 581-802	1	AMP plug-set, 3-pole (Contents: 20 pieces)

Combinable lights

009 001 series



For flush mounting

With bulb and AMP plug.

Lens without optical pattern with body bonded, with reflector.
Recommended fixing screw M4 x 12 by Ejot,
torque 2 Nm.

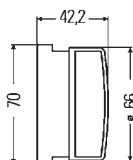
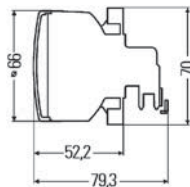

Part no.	Pk.	
		For rear mounting. Smoke coloured lens. Amber bulb.
2BA 009 001-001	1	Indicator light, 12V
2BA 009 001-007	60	
2BA 009 001-107	60	Indicator light, 24V
		Spare parts/Accessories: PY21W bulb, 10 12V 10 24V 1 Delphi plug-set, 2-pole (Contents: 20 pieces)
		For front mounting. Clear lens. Amber bulb.
2BA 009 001-071	1	Indicator light, 12V
2BA 009 001-077	60	
2BA 009 001-737	60	Indicator light without HELLA logo in the lens, 12V
2BA 009 001-167	60	Indicator light, 24V
		Spare parts/Accessories: PY21W bulb, 10 12V 10 24V 1 Delphi plug-set, 2-pole (Contents: 20 pieces)
		Silver bulb.
		Indicator light with grey lens, for rear mounting
2BA 009 001-191	1	
		Indicator light with clear lens, for front mounting
2BA 009 001-201	1	
		Spare parts/Accessories: P21W bulb, 10 12V 10 24V 1 Delphi plug-set, 2-pole (Contents: 20 pieces)
		Grey lens.
		Reverse light, 12V
2ZR 009 001-011	1	
2ZR 009 001-017	60	
2ZR 009 001-117	60	Reverse light, 24V
		Spare parts/Accessories: P21W bulb, 10 12V 10 24V 1 Delphi plug-set, 2-pole (Contents: 20 pieces)
		Reflector, red for lights in model range 009 001-...
8RA 009 001-031	1	
8RA 009 001-037	60	

Accessories for lights in model range 009 001-... (except LED)

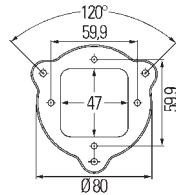

Part no.	Pk.	
9HB 161 122-007	1	Design rim silver coloured
9HB 161 122-012	10	Design rim, chrome-plated
9HB 164 168-002	10	Premium design rim comet silver coloured
8HG 162 530-002	60	Locking ring comet-silver coloured
9XD 161 119-007	30	Adapter rim with gasket, for front fixing
8JD 156 150-807	1	Plug-set, 2-pole
8JD 162 581-802	1	3-pole

Combinable lights

965 039 series

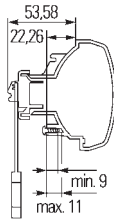
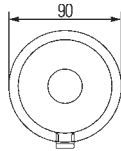

For flush mounting

With bulb.

Fixing clip and screw (Torx TX 20) are provided loose.

Lens without optical pattern. For screw- or clip fixing.
(max. depth required up to lens gradient).

Part no.	Pk.	
		Red lens. With 100 mm long lead, blade terminal contacts and insulating sleeves.
2SA 965 039-001	1	Rear light, 12V
2SA 965 039-081	1	Rear light, 24V
2SA 965 039-087	24	
2SA 965 039-307	24	Rear light with clip fixing, 24V
		Spare parts:
		R5W bulb,
8GA 002 071-121	10	12V
8GA 002 071-241	10	24V
		Red lens. With 100 mm long lead, blade terminal contacts and insulating sleeves.
2SB 965 039-051	1	Rear-stop light, 12V
2SB 965 039-057	24	
2SB 965 039-131	1	Rear-stop light, 24V
2SB 965 039-137	24	
		Red lens. With 250 mm long lead and 2-pole DEUTSCH plug connector.
2SB 965 039-397	24	Rear-stop light, 12V
		Spare parts:
		P21/5W bulb,
8GD 002 078-121	10	12V
8GD 002 078-241	10	24V
		Red lens. With 100 mm long lead, blade terminal contacts and insulating sleeves.
2DA 965 039-091	1	Stop light, 24V
2DA 965 039-317	24	Stop light with clip fixing, 12V
		Red lens. With 100 mm long lead, blade terminal contacts and insulating sleeves.
2NE 965 039-111	1	Rear fog light, 24V
2NE 965 039-117	24	
2NE 965 039-327	24	Rear fog light with clip fixing, 12V
		Spare parts:
		P21W bulb,
8GA 002 073-121	10	12V
8GA 002 073-241	10	24V
		For front mounting.
		Clear lens. With 100 mm long lead, blade terminal contacts and insulating sleeves.
2PF 965 039-071	1	Position light, 12V
2PF 965 039-151	1	Position light, 24V
		Spare parts:
		R5W bulb,
8GA 002 071-121	10	12V
8GA 002 071-241	10	24V

For flush mounting

With bulb, 100 mm long lead, blade terminal contacts and with insulating sleeves. Fixing clip and screw (Torx TX 20) are provided loose.

Lens without optical pattern. For screw- or clip fixing.
(max. depth required up to lens gradient).

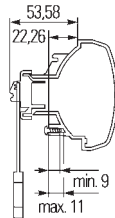
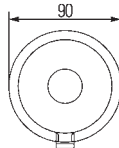

Part no.	Pk.	
		Clear lens. With 100 mm long lead, blade terminal contacts and insulating sleeves.
2PT 965 039-171	1	Daytime running light, 24V
2PT 965 039-177	24	
		Spare parts: P21W bulb,
8GA 002 073-121	10	12V
8GA 002 073-241	10	24V
		For rear flush mounting. Grey lens. Amber bulb. With 100 mm long lead, blade terminal contacts and insulating sleeves.
2BA 965 039-021	1	Indicator light, 12V
2BA 965 039-027	24	
2BA 965 039-101	1	Indicator light, 24V
2BA 965 039-107	24	
		Grey lens. Amber bulb. With 250 mm long lead and 2-pole DEUTSCH plug connector.
2BA 965 039-407	24	Indicator light, 12V
		For front mounting. Clear lens. Amber bulb. With 100 mm long lead, blade terminal contacts and insulating sleeves.
2BA 965 039-061	1	Indicator light, 12V
2BA 965 039-067	24	
2BA 965 039-141	1	Indicator light, 24V
2BA 965 039-147	24	
		Spare parts: PY21W bulb,
8GA 006 841-121	10	12V
8GA 006 841-241	10	24V
		Grey lens. With 100 mm long lead, blade terminal contacts and insulating sleeves.
2ZR 965 039-041	1	Reverse light, 12V
2ZR 965 039-047	24	
2ZR 965 039-121	1	Reverse light, 24V
2ZR 965 039-127	24	
2ZR 965 039-337	24	Reverse light with clip fixing, 12V
		Spare parts: P21W bulb,
8GA 002 073-121	10	12V
8GA 002 073-241	10	24V

Combinable lights

302 252 series



For flush mounting

With 12V bulb.

PC lens with black PC body bonded.

Two 4.1 mm dia. holes for fixing screws.

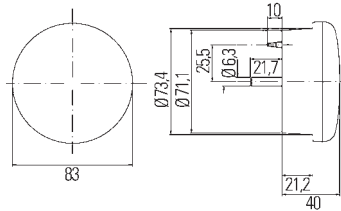

Part no.	Pk.	
		Red lens.
2SB 302 252-057	20	Rear-stop light
8GD 002 078-121	10	Spare parts: P21/5W bulb, 12V
		Red lens.
2NE 302 252-037	20	Rear fog light
8GA 002 073-121	10	Spare parts: P21W bulb, 12V
		Grey lens.
2ZR 302 252-047	20	Reverse light
8GA 002 073-121	10	Spare parts: P21W bulb, 12V
		For rear mounting.
		Amber lens.
2BA 302 252-027	20	Indicator light
8GA 002 073-121	10	Spare parts: P21W bulb, 12V

For horizontal surface mounting

Black plastic body.
Two M6 fixing screws. With grommet.

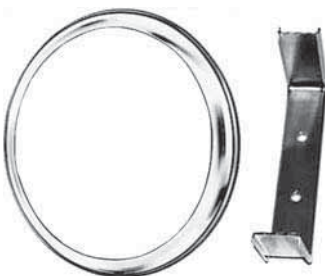
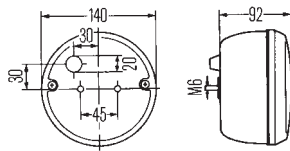

Part no.	Pk.	
		Red lens. Two lights can be fitted next to each other.
2SB 001 423-097	1	Rear-stop light
9EL 101 353-001	5	Spare parts/Accessories: Lens with screws
8GD 002 078-121	10	P21/5W bulb,
8GD 002 078-241	10	12V
8GD 002 078-011	10	24V
		24V (HD)
		Red lens.
2DA 001 423-077	24	Stop light
9EL 101 353-001	5	Spare parts/Accessories: Lens with screws
8GA 002 073-121	10	P21W bulb,
8GA 002 073-241	10	12V
		24V
		Red lens.
2NE 001 423-011	1	Rear fog light
9EL 101 353-001	5	Spare parts/Accessories: Lens with screws
8GA 002 073-121	10	P21W bulb,
8GA 002 073-241	10	12V
		24V
		Amber lens.
2BA 001 423-087	1	Indicator light
8GA 002 073-121	10	Accessories: P21W bulb,
8GA 002 073-241	10	12V
		24V
		Clear lens.
2ZR 001 423-001	1	Reverse light
9ES 106 588-001	1	Spare parts/Accessories: Lens
8GA 002 073-121	10	P21W bulb,
8GA 002 073-241	10	12V
		24V
9XD 997 909-801	1	Accessories: Mounting frame for flush mounting

Combinable lights

959 010 / 959 011 / 980 690 series



For flush mounting in towing vehicles and trailers

In LED-technology.

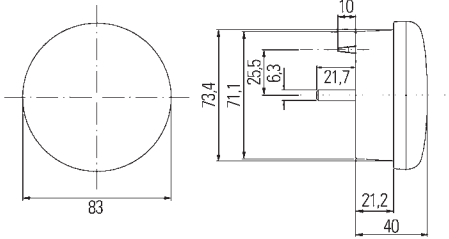

Part no.	Pk.	
		With 16 LEDs 24V and 2500 mm long lead. Red/amber lens. Rear light: 1.0W, stop light: 2.0W, indicator light: 2.0W. Consumption: 0.21A. See LED instruction 2.
2SD 959 010-401	1	Rear-stop-indicator light
2SD 959 010-407	10	
<hr/>		
		With 12 LEDs 24V and 2500 mm long lead. Red lens. Rear light: 1.0W, stop light: 3.0W. Consumption: 0.13A. See LED instruction 2.
2SB 959 010-301	1	Rear-stop light
2SB 959 010-307	10	
<hr/>		
		With 12 LEDs 24V, 150 mm long lead with 3-pole DEUTSCH plug connector and self-adhesive shrink tubing. Red lens. Rear light: 1.0W, stop light: 3.0W. Consumption: 0.13A. See LED instruction 2.
2SB 959 010-317	10	Rear-stop light
<hr/>		
		With 24 LEDs 9V - 33V and 2500 mm long lead. Red lens. Rear light: 1.0W, stop light: 3.0W. Consumption: rear light: 0.08A at 12V, 0.04A at 24V, stop light: 0.25A at 12V, 0.125A at 24V. See LED instruction 2.
2SB 959 010-001	1	Rear-stop light
<hr/>		
		With 12 LEDs 24V3.0W and 2500 mm long lead. Amber lens. Consumption: 0.13A. See LED instruction 3.
2BA 959 011-301	1	Indicator light for rear mounting
2BA 959 011-307	10	
<hr/>		
		With 13 LEDs 24V and 2500 mm long lead. Clear lens. Indicator light: 4.0W, position light: 1.0W. Consumption: 0.20A at 24V. See LED instruction 3.
2BE 980 690-301	1	Indicator-position light
9GD 980 696-001	1	Accessories: Mounting ring

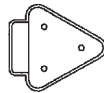

For flush mounting in towing vehicles and trailers

In LED-technology.

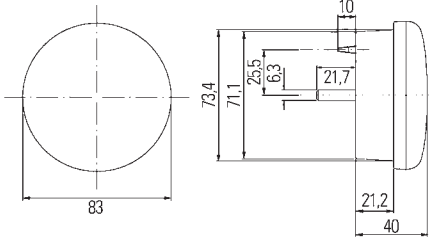

Part no.	Pk.	
2NE 959 011-501 2NE 959 011-507	1	With 24 red LEDs 3.0W and 2500 mm connecting lead. Clear lens. Consumption: 0.25A at 12V, 0.13A at 24V. Voltage range: 9V - 33V. See LED instruction 2.
	10	
2NE 959 011-527	10	With 24 red LEDs 3.0W and 200 mm long lead with 2-pole DEUTSCH plug connector. Clear lens. Consumption: 0.25A at 12V, 0.13A at 24V. Voltage range: 9V - 33V. See LED instruction 2.
2ZR 959 010-501 2ZR 959 010-507	1	With 24 white LEDs 4.0W and 2500 mm long lead. Clear lens. Consumption: 0.33A at 12V, 0.17A at 24V. Voltage range: 9V - 33V. See LED instruction 2.
	10	
9GD 980 696-001	1	Accessories: Mounting ring

For flush or surface mounting

In LED-technology. **With 24 LEDs and 500 mm long lead.**
Rear light: 1.0W, stop light: 1.5W, indicator light: 2.0W.
 Voltage range: 9V - 31V. Consumption: 0.4A at 12V, 0.2A at 24V.
 Black plastic body.
 With two M6 x 25 fixing screws.
 See LED instruction 1.

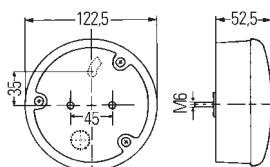

Part no.	Pk.	
2SD 344 200-001	1	Rear-stop-indicator light with clear lens
2SD 344 200-071 2SD 344 200-077	1 24	with red/clear lens

Combinable lights

344 200 series



For flush or surface mounting

In LED-technology. With 24 LEDs and 500 mm long lead.

Rear light: 1.0W, stop light: 3.0W.

Voltage range: 9V - 31V. Consumption: 0.34A at 12V, 0.17A at 24V.

Black plastic body.

With two M6 x 25 fixing screws.

See LED instruction 2.

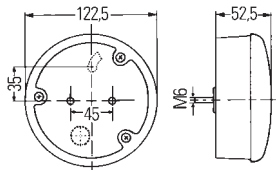

Part no.	Pk.	
2SB 344 200-027	24	Rear-stop light with clear lens
2SB 344 200-081	1	with red lens

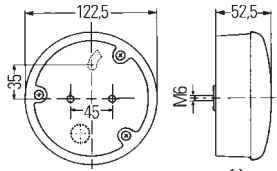

In LED-technology. With 24 LEDs 3.0W and 500 mm long lead.

Voltage range: 9V - 31V. Consumption: 0.25A at 12V, 0.13A at 24V.

Black plastic body.

With two M6 x 25 fixing screws.

Type of protection: IP6K9K. See LED instruction 3.

Part no.	Pk.	
2BA 344 200-037	24	Indicator light with clear lens

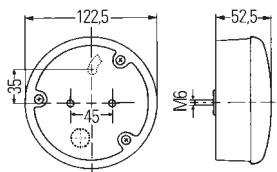

In LED-technology. With 24 LEDs 2.0W and 500 mm long lead.

Voltage range: 9V - 32V. Consumption: 0.17A at 12V, 0.08A at 24V.

Black plastic body.

With two M6 x 25 fixing screws.

Lamp turned 180°.

See LED instruction 2.

Part no.	Pk.	
2NE 344 200-061	1	Rear fog light with clear lens
2NE 344 200-091	1	with red lens
2NE 344 200-097	24	

For flush or surface mounting

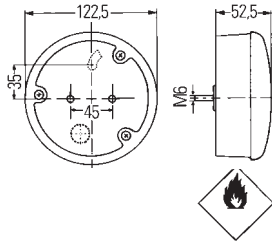

In LED-technology. With 24 LEDs 2.0W and 500 mm long lead.
 Voltage range: 9V - 31V. Consumption: 0.17A at 12V, 0.08A at 24V.
 Black plastic body.
 With two M6 x 25 fixing screws.
 See LED instruction 2.

Part no.	Pk.	
2ZR 344 200-051	1	Reverse light with clear lens
2ZR 344 200-057	24	

For flush mounting

Without legal regulations for indicator failure check, with passive electronic. The indicator failure check in the vehicle demanded by law within the scope of ECE has to be ensured. The customer is responsible for this.

In LED-technology. With 24 LEDs and 500 mm long lead.
Rear light: 1.0W, stop light: 1.5W, indicator light: 2.0W.
 Consumption: 0.4A at 12V, 0.2A at 24V.
 Black plastic body
 With two M6 x 25 fixing screws.
 Type of protection: IP6K9K. See LED instruction 4.

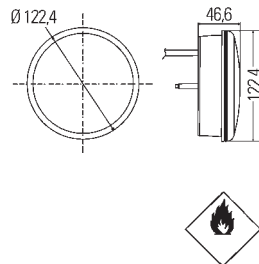

Part no.	Pk.	
2SD 344 200-201	1	Rear-stop-indicator light with clear lens, 12V
2SD 344 200-207	24	
2SD 344 200-211	1	with red/clear lens, 12V
2SD 344 200-217	24	
2SD 344 200-311	1	with red/clear lens, 24V
2SD 344 200-317	24	
2SD 344 200-251	1	with red/amber lens, 12V
4JZ 177 846-007	24	Accessories: Flasher unit, 9V - 33V
8JA 003 526-001	5	Socket, 9-pole

Combinable lights

344 200 series



For surface mounting

In LED-technology. With 24 LEDs and 500 mm long lead.

Rear light: 1.0W, stop light: 5.0W.

Consumption: 0.34A at 12V, 0.17A at 24V.

Black plastic body

With two M6 x 25 fixing screws.

Type of protection: IP6K9K. See LED instruction 2.

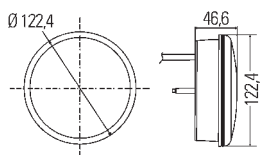

Part no.	Pk.	
2SB 344 200-221	1	Rear-stop light with clear lens, 12V
2SB 344 200-227	24	
2SB 344 200-321	1	with clear lens, 24V
2SB 344 200-327	24	
2SB 344 200-231	1	with red lens, 12V
2SB 344 200-237	24	
2SB 344 200-331	1	with red lens, 24V
2SB 344 200-337	24	

For flush mounting

Without legal regulations for indicator failure check, with passive electronic. The indicator failure check in the vehicle demanded by law within the scope of ECE has to be ensured.

The customer is responsible for this.

In LED-technology. With 24 LEDs 2.0W and 500 mm long lead.

Consumption: 0.17A at 12V, 0.09A at 24V.

Black plastic body.

With two M6 x 25 fixing screws.

Type of protection: IP6K9K. See LED instruction 4.

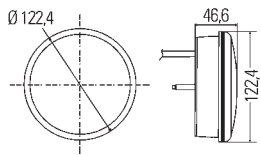

Part no.	Pk.	
2BA 344 200-241	1	Indicator light with clear lens, 12V
2BA 344 200-247	24	
2BA 344 200-341	1	with clear lens, 24V
2BA 344 200-347	24	
		Accessories:
4JZ 177 846-007	24	Flasher unit, 9V - 33V
8JA 003 526-001	5	Socket, 9-pole

For flush or surface mounting

In LED-technology. With 37 LEDs and 500 mm long lead.

Black plastic body.
With two M6 x 25 fixing screws.
See LED instruction 4.

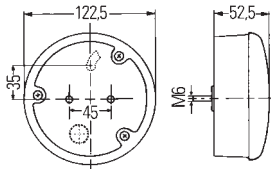

Part no.	Pk.	
		Clear lens. Rear light: 0.7W, stop light: 5.0W, indicator light: 4.6W. Consumption: 0.86A at 12V, 0.43A at 24V.
2SD 964 169-411	1	Rear-stop-indicator light, left, 12V
2SD 964 169-401	1	Rear-stop-indicator light, right, 12V
2SD 964 169-331	1	Rear-stop-indicator light, left, 24V
2SD 964 169-421	1	Rear-stop-indicator light, right, 24V
		Accessories:
4JZ 177 846-007	24	Flasher unit, 9V - 33V
8JA 003 526-001	5	Socket, 9-pole

In LED-technology. With 37 LEDs and 500 mm long lead.

Black plastic body.
With two M6 x 25 fixing screws.
See LED instruction 2.

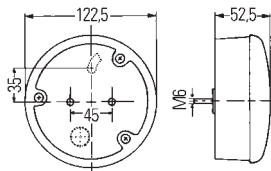
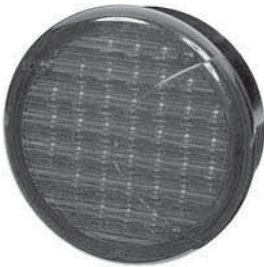

Part no.	Pk.	
		Red lens. Rear light: 0.7W, stop light: 5.0W. Consumption: 0.24A.
2SB 964 169-301	1	Rear-stop light, 24V
2SB 964 169-307	36	

Without legal regulations for indicator failure check, with passive electronic. The indicator failure check in the vehicle demanded by law within the scope of ECE has to be ensured.

The customer is responsible for this.



In LED-technology. With 37 LEDs.

Black plastic body.
With two M6 x 25 fixing screws.
See LED instruction 4.

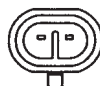
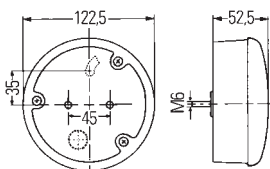

Part no.	Pk.	
		Amber lens. Indicator light: 9.0W. Consumption: 0.38A at 24V.
2BA 964 169-311	1	Indicator light, 24V, with 500 mm long lead with stripped ends
2BA 344 169-191	1	Indicator light, 24V, with 200 mm long lead and 2-pole AMP Superseal plug connector
		Accessories:
4JZ 177 846-007	24	Flasher unit, 9V - 33V
8JA 003 526-001	5	Socket, 9-pole

Combinable lights

964 169 / 344 169 series



For flush or surface mounting

In LED-technology. With 37 LEDs and 500 mm long lead.

Black plastic body.
With two M6 x 25 fixing screws.
See LED instruction 2.

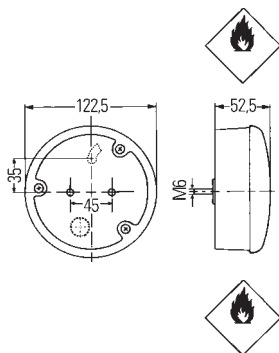
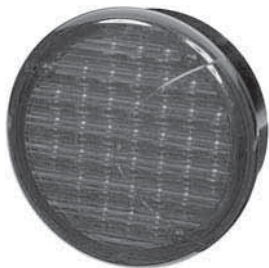

Part no.	Pk.	
2NE 964 169-341	1	Red lens. Rear fog light: 4.0W. Consumption: 0.17A.
		Rear fog light, 24V
2ZR 964 169-351	1	Clear lens. Reverse light: 5.0W. Consumption: 0.21A.
		Reverse light, 24V, left
2ZR 964 169-361	1	Reverse light, 24V, right

In LED-technology. With 9 red LEDs for rear fog light, 21 white LEDs for reverse light and 500 mm long lead with stripped ends. Clear lens.

Black plastic body.
With two M6 x 20 fixing screws.
Lamp turned 180°.
See LED instruction 2.

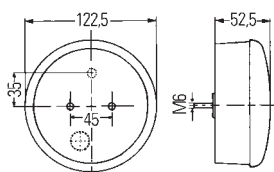

Part no.	Pk.	
2NR 344 169-441	1	Rear fog light: 2.0W, reverse light: 4.5W. Consumption: 0.5A.
		Rear fog-reverse light, 12V
2NR 344 169-461	1	Rear fog light: 2.8W, reverse light: 5.0W. Consumption: 0.33A.
		Rear fog-reverse light, 24V

For flush or surface mounting

Caution: The water drainage opening must be knocked out according to the attachment position!
Black plastic body.

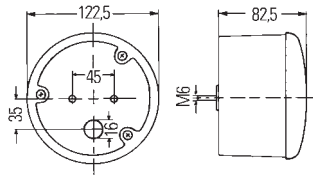
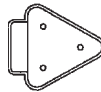

Part no.	Pk.	
		Red lens, without optical pattern. With grommet.
2SB 964 169-531	1	Rear-stop light
2SB 964 169-537	20	with two M6 x 25 fixing screws
2SB 964 169-677	20	Rear-stop light without fixing screws
2SB 344 169-017	20	Red lens, without optical pattern. with 200 mm long lead, 24V bulb and 3-pole DEUTSCH plug connector. Rear-stop light with two M6 x 25 fixing screws
9GT 341 438-007	200	Spare parts/Accessories: Grommet
8GD 002 078-121	10	P21/5W bulb,
8GD 002 078-241	10	12V 24V
2NE 964 169-521	1	Red lens, without optical pattern. With grommet.
2NE 964 169-527	20	Rear fog light with two M6 x 25 fixing screws
2BA 964 169-501	1	Amber lens, without optical pattern. With grommet.
2BA 964 169-507	20	Indicator light with two M6 x 25 fixing screws
2BA 344 169-007	20	Amber lens, without optical pattern. With 200 mm long lead, 24V bulb and 2-pole DEUTSCH plug connector. Indicator light with two M6 x 25 fixing screws
2ZR 964 169-511	1	Clear lens, without optical pattern. With grommet.
2ZR 964 169-517	20	Reverse light with two M6 x 25 fixing screws
9GT 341 438-007	200	Spare parts/Accessories: Grommet
8GA 002 073-121	10	P21W bulb,
8GA 002 073-241	10	12V 24V

Combinable lights

964 169 / 344 169 series



For surface or flush mounting

Caution: The water drainage opening must be knocked out according to the attachment position!

Black plastic body.

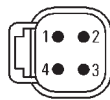
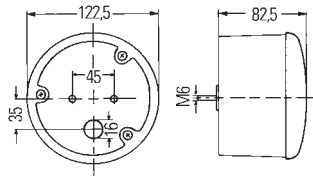

Part no.	Pk.	
		Red rear and stop light, amber indicator light. With grommet.
2SD 964 169-111	1	Rear-stop-indicator light with two M6 x 25 fixing screws
2SD 964 169-117	20	Rear-stop-indicator light with two M6 x 12 fixing screws
2SD 344 169-037	20	Spare parts/Accessories: 9EL 964 536-001 1 Lens with screws 9GT 341 438-007 200 Grommet P21/5W bulb, 8GD 002 078-121 10 12V 8GD 002 078-241 10 24V P21W bulb, 8GA 002 073-121 10 12V 8GA 002 073-241 10 24V
		Red rear and stop light, amber indicator light. With 200 mm long lead and 4-pole Amphenol plug.
2SD 344 169-237	20	Rear-stop-indicator light with 12V bulbs and two M6 x 25 fixing screws, left
2SD 344 169-247	20	Rear-stop-indicator light with 12V bulbs and two M6 x 25 fixing screws, right
2SD 344 169-137	20	Rear-stop-indicator light with 24V bulbs and two M6 x 25 fixing screws, left
2SD 344 169-147	20	Rear-stop-indicator light with 24V bulbs and two M6 x 25 fixing screws, right
		Spare parts: 9EL 964 536-001 1 Lens with screws P21/5W bulb, 8GD 002 078-121 10 12V 8GD 002 078-241 10 24V P21W bulb, 8GA 002 073-121 10 12V 8GA 002 073-241 10 24V
		Red lens. With grommet. Two lights can be fitted next to each other.
2SA 964 169-091	1	Rear light with two M6 x 25 fixing screws
2SA 964 169-097	20	Rear light without fixing screws
2SA 964 169-277	20	Spare parts/Accessories: 9GT 341 438-007 200 Grommet R5W bulb, 8GA 002 071-121 10 12V 8GA 002 071-241 10 24V

For surface or flush mounting

Caution: The water drainage opening must be knocked out according to the attachment position!

Black plastic body.

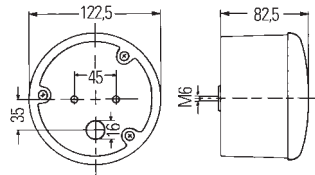
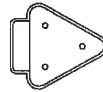
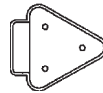

Part no.	Pk.	
		Red lens. With grommet.
2TA 964 169-061	1	Rear-stop light with reflector with two M6 x 25 fixing screws
2TA 964 169-067	20	
		Red lens.
		With 150 mm long lead, bulb and 3-pole DEUTSCH plug connector.
2TA 964 169-797	20	Rear-stop light with reflector, 12V, with two M6 x 45 fixing screws, left
2TA 964 169-767	20	Rear-stop light with reflector, 12V, with two M6 x 45 fixing screws, right
2TA 344 169-077	20	Rear-stop light with reflector, 24V, with two M6 x 25 fixing screws, left
2TA 344 169-087	20	Rear-stop light with reflector, 24V, with two M6 x 25 fixing screws, right
		Red lens. With grommet.
		For two-wheeled vehicles.
2SB 964 169-287	20	Rear-stop light with two M6 x 25 fixing screws
2SB 964 169-717	20	Rear-stop light without fixing screws
		Spare parts/Accessories:
9EL 964 532-001	1	Lens with screws for 2TA 964 169-...
9GT 341 438-007	200	Grommet
8GD 002 078-121	10	P21/5W bulb, 12V
8GD 002 078-241	10	24V

Combinable lights

964 169 / 344 169 series



For flush or surface mounting

Caution: The water drainage opening must be knocked out according to the attachment position!
Black plastic body.

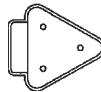
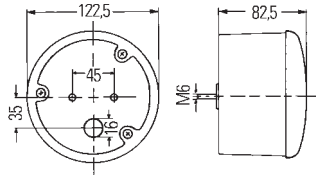

Part no.	Pk.	
		Red rear light, amber indicator light. With grommet.
2SW 964 169-081	1	Rear-indicator light with two M6 x 25 fixing screws
2SW 964 169-087	20	
		Spare parts/Accessories:
9EL 964 534-001	1	Lens with screws
9GT 341 438-007	200	Grommet
8GA 002 071-121	10	R5W bulb, 12V
8GA 002 071-241	10	24V
8GA 002 073-121	10	P21W bulb, 12V
8GA 002 073-241	10	24V
		Red lens. With grommet. Two lights can be fitted next to each other.
		Stop light with two M6 x 25 fixing screws
2DA 964 169-001	1	
2DA 964 169-007	20	
		Red lens. With grommet.
		Rear fog light with two M6 x 25 fixing screws
2NE 964 169-021	1	
2NE 964 169-027	20	
		Rear fog light without fixing screws
2NE 964 169-227	20	
		Red lens. With 24V bulb, 200 mm long lead and 3-pole DEUTSCH plug connector.
		Rear fog light with two M6 x 25 fixing screws, left
2NE 344 169-117	20	
		Rear fog light with two M6 x 25 fixing screws, right
2NE 344 169-067	20	
		Amber lens (category 1a / 2a). With grommet. Two lights can be fitted next to each other.
		Indicator light with two M6 x 25 fixing screws
2BA 964 169-011	1	
2BA 964 169-017	20	
		Indicator light without fixing screws
2BA 344 169-027	20	
		Spare parts/Accessories:
9EL 964 526-001	1	Lens with screws for 2DA 964 169-...
9EL 964 527-001	1	for 2BA 964 169-...
9GT 341 438-007	200	Grommet
8GA 002 073-121	10	P21W bulb, 12V
8GA 002 073-241	10	24V

For flush or surface mounting

Caution: The water drainage opening must be knocked out according to the attachment position!

Black plastic body.

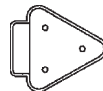
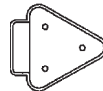
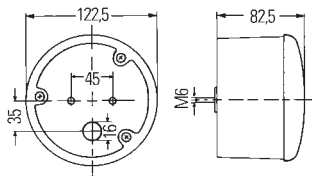

Part no.	Pk.	Description
		Amber indicator light, red rear fog light. With grommet.
2BA 964 169-041	1	Indicator-rear fog light with two M6 x 25 fixing screws
2BA 964 169-047	20	
		Amber indicator light, white reverse light. With grommet.
2BN 964 169-051	1	Indicator-reverse light with two M6 x 25 fixing screws
2BN 964 169-057	20	
2BN 964 169-247	20	Indicator-reverse light without fixing screws
		Amber indicator light, clear reverse light. With 150 mm long lead and 3-pole DEUTSCH plug connector.
2BN 964 169-777	20	Indicator-reverse light with two M6 x 45 fixing screws and 12V bulbs, left
2BN 964 169-787	20	Indicator-reverse light with two M6 x 45 fixing screws and 12V bulbs, right
2BN 344 169-097	20	Indicator-reverse light with two M6 x 25 fixing screws and 24V bulbs, left
2BN 344 169-107	20	Indicator-reverse light with two M6 x 25 fixing screws and 24V bulbs, right
		Spare parts/Accessories:
9EL 964 530-001	1	Lens with screws for 2BA 964 169-...
9EL 964 531-001	1	for 2BN 964 169-... / 2BN 344 169-...
9GT 341 438-007	200	Grommet
8GA 002 073-121	10	P21W bulb, 12V
8GA 002 073-241	10	24V

Combinable lights

964 169 / 344 169 series



For flush or surface mounting

Caution: The water drainage opening must be knocked out according to the attachment position!
Black plastic body.

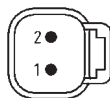
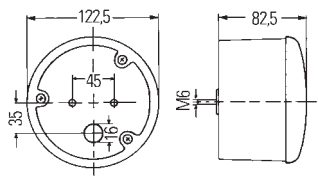

Part no.	Pk.	
		For front flush/surface mounting. Amber indicator light, clear position light. With grommet.
2BE 964 169-071	1	
2BE 964 169-077	20	Indicator-position light with two M6 x 25 fixing screws
		Spare parts/Accessories:
9EL 964 533-001	1	Lens with screws
9GT 341 438-007	200	Grommet
8GA 002 071-121	10	R5W bulb, 12V
8GA 002 071-241	10	24V
8GA 002 073-121	10	P21W bulb, 12V
8GA 002 073-241	10	24V
		Clear lens. With grommet.
		Reverse light with two M6 x 25 fixing screws
2ZR 964 169-031	1	
2ZR 964 169-037	20	
		Clear lens. With grommet, 160 mm long lead, blade terminals and 12V bulb.
		Reverse light with two M6 x 25 fixing screws
2ZR 964 169-107	20	
		Spare parts/Accessories:
9EL 964 529-001	1	Lens with screws
9GT 341 438-007	200	Grommet
8GA 002 073-121	10	P21W bulb, 12V
8GA 002 073-241	10	24V
		Clear lens. With 24V bulb, 200 mm long lead and 2-pole Amphenol plug connector.
		Reverse light with two M6 x 25 fixing screws, left
2ZR 344 169-157	20	
		Reverse light with two M6 x 25 fixing screws, right
2ZR 344 169-167	20	
		Spare parts/Accessories:
9EL 964 529-001	1	Lens with screws
8GA 002 073-241	10	P21W bulb, 24V

For surface mounting on towing vehicles and trailers

EuroLED

In LED-technology. With 1 Power-LED.

Firmly sealed with black base plate.

Electrical connection by means of a 2500 mm long lead.

Two 5.3 mm dia. holes for fixing screws.

Voltage range: 9V - 33V.

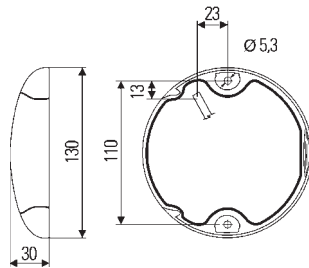

Part no.	Pk.	
2SB 959 821-601	1	Red lens. With 1 red LED. Consumption: 0.21A at 12V, 0.10A at 24V. See LED instruction 2.
		Tail-stop light, 2.5W
2BA 959 822-601	1	Amber lens. With 1 amber LED. Consumption: 0.21A at 12V, 0.10A at 24V. See LED instruction 3.
		Indicator light, 2.5W
2NE 959 821-201	1	Clear lens. With 1 red LED. Consumption: 0.33A at 12V, 0.17 at 24V. See LED instruction 2.
		Rear fog light, 4.0W
2ZR 959 820-601	1	White lens. With 1 white LED. Consumption: 0.21A at 12V, 0.10A at 24V. See LED instruction 2.
		Reverse light, 2.5W
2JA 959 820-501	1	White lens. With 1 white LED. Consumption: 0.33A at 12V, 0.17A at 24V.
		Interior light, 4.0W

EuroLED Touch

In LED-technology. Clear lens.

With 1 white and 8 red LEDs.

Consumption: 0.25A at 12V, 0.13A at 24V.

With sensitive switch, for on/off and dimming function, also change between white and red night light.

With 2500 mm long lead.

Two 5.3 mm dia holes for fixing screws.

Voltage range: 9V - 33V.

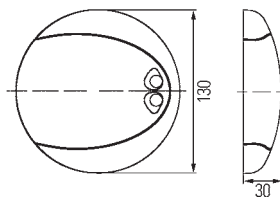

Part no.	Pk.	
2JA 959 950-031	1	Interior light, 3.0W, with black cover plate
2JA 959 950-017	12	
2JA 959 950-041	1	with white cover plate

Combinable lights

001 240 series



For flush mounting

Chrome-plated rim. Rubber body. Mounting depth 45 mm.
Three M4 fixing screws. Bulb holder with vibration damping.

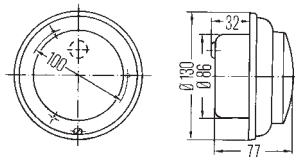

Part no.	Pk.	
		Red lens. Two lights can be fitted next to each other.
2SB 001 240-311	1	Rear-stop light (only for spare parts requirement)
8GA 002 071-131	10	Accessories: R10W bulb, 12V
8GA 002 071-251	10	24V
8GA 002 073-121	10	P21W bulb, 12V
8GA 002 073-241	10	24V
		Red lens. Two lights can be fitted next to each other.
2SA 001 240-331	1	Rear light
8GA 002 071-121	10	Accessories: R5W bulb, 12V
8GA 002 071-241	10	24V
		Red lens.
2DA 001 240-341	1	Stop light (only for spare parts requirement)
8GA 002 073-121	10	Accessories: P21W bulb, 12V
8GA 002 073-241	10	24V
		Amber lens (category 2a).
2BA 001 240-301	1	Indicator light
9EM 128 229-011	1	Spare parts/Accessories: Lens with rim and reflector
8GA 002 073-121	10	P21W bulb, 12V
8GA 002 073-241	10	24V
		Clear lens.
2ZR 001 240-351	1	Reverse light
		Reverse light with black plastic rim, not resistant to UV-radiation, frame must be covered when installed
2ZR 001 240-377	30	Accessories: P21W bulb, 12V
8GA 002 073-121	10	24V
8GA 002 073-241	10	

for vertical mounting

AgrolunaLED

In LED-technology. Clear lens.
 With integrated electronic for cancellation control of indicator light.
 12 red LEDs for rear and stop light
 (rear light with reduced power), 12 amber LEDs for indicator light.
 With 4-pole DEUTSCH plug connector.

Two 6 mm dia. holes for fixing screws. Voltage range: 9V - 32V.
 See LED instruction 1, 2, 3.

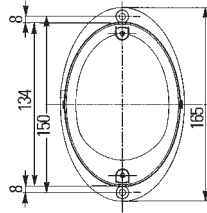
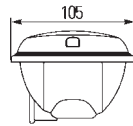

1	indicator
2	rear
3	ground
4	stop



Part no.	Pk.	
		Rear light: 0.5W, stop light: 1.6W, indicator light: 2.0W. Consumption: 0.34A at 12V, 0.17A at 24V.
2SD 343 390-401	1	Rear-stop-indicator light, left and right
2SD 343 390-407	24	

For horizontal or vertical surface mounting

In LED-technology. Clear lens.
 With integrated electronic for cancellation control of indicator light.
 12 red LEDs for rear and stop light
 (rear light with reduced power), 12 amber LEDs for indicator light.
 With 4-pole DEUTSCH plug connector.

Two M6 fixing screws. Voltage range: 9V - 32V.
 Type of protection: IP69. See LED instruction 1, 2, 3.

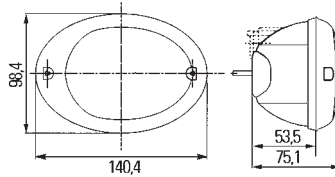

1	indicator
2	rear
3	ground
4	stop



Part no.	Pk.	
		Rear light: 0.5W, stop light: 1.6W, indicator light: 2.0W. Consumption: 0.34A at 12V, 0.17A at 24V.
2SD 343 390-417	1	Rear-stop-indicator light, left and right

In LED-technology. Clear lens.
 With integrated electronic for cancellation control of indicator light.
 12 red LEDs for rear and stop light,
 12 amber LEDs for indicator light.
 With 100 mm long lead.

Two M6 fixing screws. Voltage range: 9V - 32V.
 Type of protection: IP6K9K. See LED instruction 1, 2, 3.

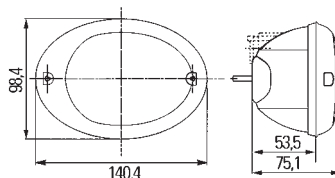

Part no.	Pk.	
		Rear light: 0.5W, stop light: 1.6W, indicator light: 2.0W. Consumption: 0.34A at 12V, 0.17A at 24V.
2SD 343 390-707	24	Rear-stop-indicator light, left and right

For horizontal or vertical surface mounting

AgrolunaLED

In LED-technology. Clear lens.

With integrated electronic for cancellation control of indicator light.

With 100 mm long lead.

Two 6 mm dia. holes for fixing screws. Voltage range: 9V - 32V.

See LED instruction 1, 2, 3.

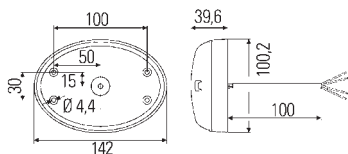

Part no.	Pk.	
2SD 343 390-011	1	<p>12 red LEDs for rear and stop light (rear light with reduced power), 12 amber LEDs for indicator light. Rear light: 0.67W, stop light: 2.5W, indicator light: 2.9W. Consumption: 0.5A at 12V, 0.25A at 24V.</p> <p>Rear-stop-indicator light, left and right</p>
	1	<p>24 red LEDs for rear and stop light (rear light with reduced power). Rear light: 0.5W, stop light: 2.4W. Consumption: 0,24A bei 12V, 0,12A bei 24V.</p> <p>Rear-stop light, left and right</p>
2SB 343 390-091	1	<p>With 24 amber LEDs for indicator light. Indicator light: 3.2W. Consumption: 0.26A at 12V, 0.13A at 24V.</p> <p>Indicator light, left and right</p>

For vertical flush mounting

Agroluna

With 4-pole DEUTSCH plug connector.
All lights are suitable ADR.
Two 6 mm dia. holes for fixing screws.

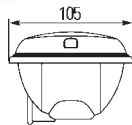

1	indicator
2	rear
3	ground
4	stop

Part no.	Pk.	Description
2SD 343 130-377	24	Red rear and stop light, amber indicator light. With 12V bulbs.
8GD 002 078-121	10	P21/5W bulb, 12V
8GD 002 078-241	10	P21W bulb, 24V
8GA 002 073-121	10	P21W bulb, 12V
8GA 002 073-241	10	P21W bulb, 24V

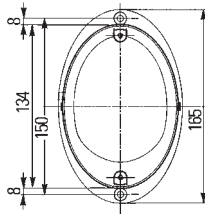

2SD 343 130-337	24	Red rear and stop light, amber indicator light. With 24V HD bulb.
8GD 002 078-011	10	P21/5W HD bulb, 24V
8GA 002 073-251	10	P21W HD bulb, 24V



1	free
2	free
3	ground
4	indicator

2BA 344 130-747	24	Amber lens. With 12V bulb.
9EL 343 134-011	1	Lens
8GA 002 073-121	10	P21W bulb, 12V



1	indicator
2	free
3	ground
4	position

2BE 344 130-777	24	Amber indicator light, white position light. With 12V bulb.
8GA 002 073-121	10	P21W bulb, 12V
8GA 002 071-121	10	R10W bulb, 12V



1	free
2	free
3	ground
4	reverse

2ZR 343 130-387	24	Clear lens. With 12V bulb.
9EL 343 134-051	1	Lens
8GA 002 073-121	10	P21W bulb, 12V

Combinable lights

343 130 series



For horizontal flush mounting

Agroluna

Two 6 mm dia. holes for fixing screws.



1	indicator
2	rear
3	ground
4	stop

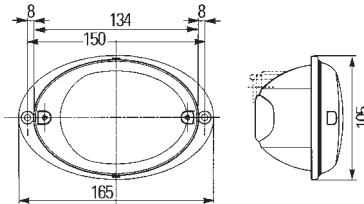

1	free
2	rear fog
3	ground
4	free

Part no.	Pk.	
		Red rear and stop light, amber indicator light. With 4-pole DEUTSCH plug connector and 12V bulbs.
2SD 343 130-737	24	Rear-stop-indicator light, left
2SD 343 130-747	24	Rear-stop-indicator light, right
		Red rear and stop light, amber indicator light. With grommet and 24V HD bulbs.
2SD 343 130-397	24	Rear-stop-indicator light, left
2SD 343 130-227	24	Rear-stop-indicator light, right
		Spare parts: P21W bulb, 12V
8GA 002 073-121	10	12V
8GA 002 073-251	10	24V (HD)
		P21/5W bulb, 12V
8GD 002 078-121	10	12V
8GD 002 078-011	10	24V (HD)
		Red lens. With 12V bulb and 6.3 mm blade terminal contacts.
2SB 343 400-317	30	Rear-stop light, left
2SB 343 400-327	30	Rear-stop light, right
		Spare parts: P21/5W bulb, 12V
8GD 002 078-121	10	P21/5W bulb, 12V
		Red lens. With grommet, 12V bulb and 120 mm long lead with 6.3 mm blade terminal contacts.
		Stop light with 24V bulbs, left
2DA 344 130-617	24	with 24V bulbs, left
		Stop light with 24V bulbs, right
2DA 344 130-607	24	with 24V bulbs, right
		Red lens. With grommet, 12V bulb and 100 mm long lead with 6.3 mm blade terminal contacts.
2NE 343 130-277	24	Rear fog light, left
		Red lens. With 4-pole DEUTSCH plug connector and 12V bulb.
2NE 343 130-177	30	Rear fog light, left
		Spare parts: Lens for 2DA
9EL 343 134-061	1	for 2DA
9EL 343 134-041	1	for 2NE
		P21W bulb, 12V
8GA 002 073-121	10	12V
8GA 002 073-241	10	24V

For horizontal flush mounting

Agroluna

Two 6 mm dia. holes for fixing screws.



1	indicator
2	free
3	ground
4	position

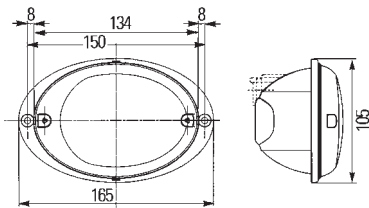

Part no.	Pk.	
		Amber indicator light, clear position light. With 4-pole DEUTSCH plug connector and 12V bulbs.
2BE 343 130-657	24	Indicator-position light, left
2BE 343 130-667	24	Indicator-position light, right
		Amber indicator light, clear position light. With grommet, without bulbs.
2BE 343 130-777	24	Indicator-position light, left
2BE 343 130-787	24	Indicator-position light, right
		Spare parts/Accessories:
8GA 002 071-131	10	R10W bulb, 12V
8GA 002 073-121	10	P21W bulb, 12V
		Amber lens. With grommet, 100 mm long lead and 6.3 mm blade terminals.
2BA 343 130-297	24	Indicator light with 12V bulbs, left
2BA 343 130-307	24	Indicator light with 12V bulbs, right
2BA 343 130-537	24	Indicator light with 24V bulbs, left
2BA 343 130-547	24	Indicator light with 24V bulbs, right
		Spare parts:
9EL 343 134-011	1	Lens
8GA 002 073-121	10	12V P21W bulb,
8GA 002 073-241	10	24V

Combinable lights

343 130 series



For horizontal surface mounting

Agroluna

Black plastic body.
Two M5 x 40 fixing screws, distance between screws: 50 mm,
for side (mirror) mounting.

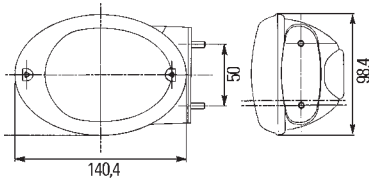
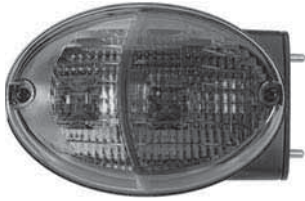

Part no.	Pk.	
		Red rear and stop light, amber indicator light.
2SD 343 130-797	30	Rear-stop-indicator light, left
2SD 343 130-807	30	Rear-stop-indicator light, right
		Spare parts/Accessories:
		P21/5W bulb,
8GD 002 078-121	10	12V
8GD 002 078-241	10	24V
		P21W bulb,
8GA 002 073-121	10	12V
8GA 002 073-241	10	24V
		Amber indicator light, clear position light. With 12V bulbs.
2BE 343 130-411	1	Indicator-position light, left
2BE 343 130-417	30	
2BE 343 130-421	1	Indicator-position light, right
2BE 343 130-427	30	
		Spare parts:
8GA 002 071-131	10	R10W bulb, 12V
8GA 002 073-121	10	P21W bulb, 12V

For horizontal or vertical flush/surface mounting

Agroluna



Caution: The water drainage opening must be knocked out according to the attachment position!
Please refer to the installation instructions.
All lights are suitable ADR.
 Two M6 x16 fixing screws.



1	indicator
2	rear
3	ground
4	stop

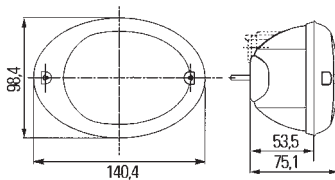

1	free
2	rear
3	ground
4	stop



Part no.	Pk.	Description
		Red rear and stop light, amber indicator light. With grommet.
2SD 343 130-011	1	Rear-stop-indicator light, 12V/24V
2SD 343 130-017	30	
		Red rear and stop light, amber indicator light. With 4-pole DEUTSCH plug connector and 12V bulbs.
2SD 343 130-071	1	Rear-stop-indicator light
		For horizontal mounting. Red rear and stop light, amber indicator light. With 4-pole DEUTSCH plug connector and 12V bulbs.
2SD 343 130-157	30	Rear-stop-indicator light, left
2SD 343 130-167	30	Rear-stop-indicator light, right
		For horizontal mounting. Red rear and stop light, amber indicator light. With 4-pole DEUTSCH plug connector and 24V bulbs.
2SD 343 130-137	30	Rear-stop-indicator light, left
2SD 343 130-147	30	Rear-stop-indicator light, right
		Spare parts/Accessories:
8GD 002 078-121	10	12V
8GD 002 078-241	10	24V
8GA 002 073-121	10	12V
8GA 002 073-241	10	24V
		Red lens, with grommet.
2SB 343 130-027	30	Rear-stop light
		Red lens. With 4-pole DEUTSCH plug connector and 12V bulbs.
2SB 343 130-757	30	Rear-stop light, left
2SB 343 130-767	30	Rear-stop light, right
		Spare parts/Accessories:
9EL 343 134-021	1	Lens
8GD 002 078-121	10	P21/5W bulb, 12V
8GD 002 078-241	10	P21/5W bulb, 24V
		Red lens, with grommet.
2NE 343 130-031	1	Rear fog light
2NE 343 130-037	30	
		Spare parts/Accessories:
9EL 343 134-041	1	Lens
8GA 002 073-121	10	P21W bulb, 12V
8GA 002 073-241	10	P21W bulb, 24V

Combinable lights

343 130 series



For horizontal or vertical flush/surface mounting

Agroluna



Caution: The water drainage opening must be knocked out according to the attachment position!
Please refer to the installation instructions.
All lights are suitable ADR.
 Two M6 x16 fixing screws.

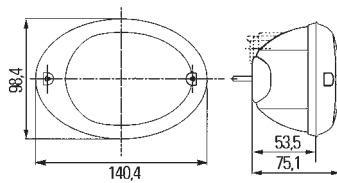
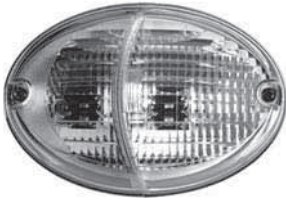

1	free
2	free
3	ground
4	indicator



1	free
2	free
3	ground
4	reverse



Part no.	Pk.	Description
		Amber indicator light, clear position light. With grommet.
2BE 343 130-001	1	Indicator-position light, 12V, with 45 mm distance between screws
2BE 343 130-007	30	
2BE 343 130-081	1	Indicator-position light, 12V, with 58 mm distance between screws
		Spare parts/Accessories:
		R10W bulb,
8GA 002 071-131	10	12V
8GA 002 071-251	10	24V
		P21W bulb,
8GA 002 073-121	10	12V
8GA 002 073-241	10	24V
		Amber lens, with grommet.
2BA 343 130-051	1	Indicator light
2BA 343 130-057	30	
		Amber lens. With 4-pole DEUTSCH plug connector.
2BA 343 130-577	30	Indicator light with 12V bulbs, left
2BA 343 130-587	30	Indicator light with 12V bulbs, right
2BA 344 130-237	30	Indicator light with 24V bulbs, left
2BA 344 130-247	30	Indicator light with 24V bulbs, right
		Spare parts:
9EL 343 134-011	1	Lens
		P21W bulb,
8GA 002 073-121	10	12V
8GA 002 073-241	10	24V
		Clear lens. With grommet.
2ZR 343 130-041	1	Reverse light
2ZR 343 130-047	30	
		Clear lens. With 4-pole DEUTSCH plug connector and 12V bulb.
2ZR 343 130-607	30	Reverse light, right
		Spare parts/Accessories:
9EL 343 134-051	1	Lens
		P21W bulb,
8GA 002 073-121	10	12V
8GA 002 073-241	10	24V

For rear surface mounting

Two M5 fixing screws.

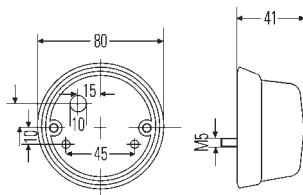
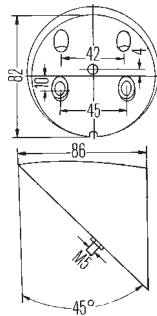
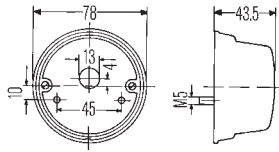

Part no.	Pk.	
2SB 001 259-261	2	Red rear light, amber stop (indicator) light. National type test for Germany.
		Rear-stop-(indicator) light
2ST 001 259-321	2	Red rear light, amber stop (indicator) light, with illumination for 340 x 240 mm and 240 x 130 mm licence plates with 0°, 15° and 30° inclination. National type test for Germany.
		Rear-stop-(indicator)-licence plate light
		Spare parts/Accessories:
9EL 088 525-001	2	Lens with screws for -261
9FT 088 047-001	10	Bulb holder K bulb,
8GM 002 091-131	10	12V10W
8GM 002 091-121	10	12V18W
8HG 002 247-001	2	Adapter for surface-mounting to bodywork surfaces inclined at 45°, for 001 259-261/-321
		Red lens. Two lights can be fitted next to each other.
2SA 001 259-751 2SA 001 259-757	2 90	Rear light
		Spare parts/Accessories:
9EL 135 266-001	2	Lens with screws
9FT 088 047-001	10	Bulb holder
8GM 002 092-121	10	C5W bulb, 12V
		Red lens. With illumination for 340 x 240 mm, 240 x 130 mm and 520 x 120 mm licence plates. National type test for Germany.
2TF 001 259-761	2	Rear-licence plate light
		Spare parts/Accessories:
9FT 088 047-001	10	Bulb holder
8GM 002 091-131	10	K bulb, 12V10W

Combinable lights

001 259 series



For front surface mounting

Two M5 fixing screws.

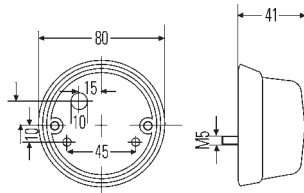

Part no.	Pk.	
2PF 001 259-631	2	Clear lens.
9EL 109 208-011	2	Position light
9FT 088 047-001	10	Spare parts/Accessories:
8GM 002 092-121	10	2 Lens with screws
		10 Bulb holder
		10 C5W bulb, 12V
		Green lens.
		Vehicles whose trailers are equipped with ABS and do not yet have plug connectors to ISO 3731 (24S), ISO 7683 or ISO 1185 (24N) are required to equip the trailer with a green position light located in the field of vision of the outside mirror on the driver side for indicating the function of the ABS.
2PF 001 259-677	108	Position light
9FT 088 047-001	10	Spare parts/Accessories:
8GM 002 092-121	10	10 Bulb holder
		10 C5W bulb, 12V
		Amber indicator light, white position light.
		National type test for Germany.
2BE 001 259-061	2	Indicator-position light
9EL 088 538-001	2	Spare parts/Accessories:
8GM 002 091-121	10	2 Lens with screws
8GM 002 094-121	10	10 K bulb, 12V
	10	10 M bulb, 12V
8HG 002 247-001	2	Adapter for surface-mounting to bodywork surfaces inclined at 45°, for 001 259-061

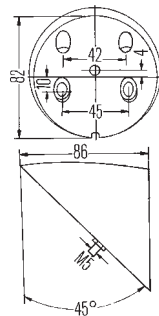
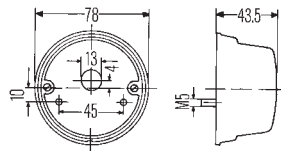

For front or rear surface mounting

Two M5 fixing screws.

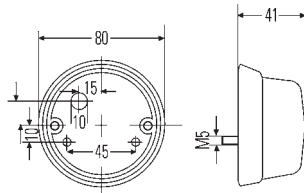

Part no.	Pk.	
		Amber lens (category 1 and 2a). National type test for Germany.
		Indicator light for front or rear surface mounting
2BA 001 259-611	2	
2BA 001 259-618	90	
		Spare parts/Accessories:
9EL 088 150-001	2	Lens with screws
9FT 088 047-001	10	Bulb holder
8GM 002 091-121	10	K bulb, 12V
		Clear lens.
2ZR 001 421-101	4	Reverse light
		Accessories:
8GM 002 091-181	10	C21W bulb, 12V

Combinable lights

003 057 - 005 639 series



For horizontal or vertical surface mounting

Plastic base plate.
Two holes for M5 fixing screws.

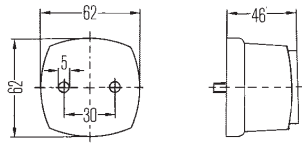

Part no.	Pk.	
2TM 003 057-031	1	Red lens. Rear light with reflector (only for spare parts requirement)

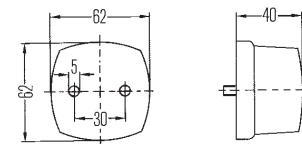

2SA 003 057-021	1	Red lens. Black base plate. Two lights can be fitted next to each other. Rear light
9EL 117 330-011	2	Spare parts/Accessories: Lens for -021
8GM 002 092-121	10	C5W bulb,
8GM 002 092-241	10	12V
	10	24V



2PF 003 057-001	1	For front mounting. Clear lens. Position light with white base plate
------------------------	---	---

2PF 003 057-041	1	Position light with black base plate
------------------------	---	---



2PG 003 057-011	1	Position light with reflector and white base plate
------------------------	---	---

2PG 003 057-061	1	Position light with reflector and black base plate
2PG 003 057-067	60	

9EL 117 330-001	2	Spare parts/Accessories: Lens for -001/-002/-041
9EL 117 334-001	2	for -011/-012/-067
		C5W bulb,
8GM 002 092-121	10	12V
8GM 002 092-241	10	24V



2PS 003 057-051	1	Amber lens. With white base plate. Side-marker light with reflector
2PS 003 057-057	60	

9EL 117 334-021	2	Spare parts/Accessories: Lens
		C5W bulb,
8GM 002 092-121	10	12V
8GM 002 092-241	10	24V

For horizontal surface mounting

Plastic base plate.
Two holes for M5 fixing screws.

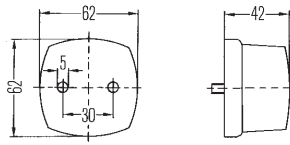

Part no.	Pk.	
		For front mounting. Clear lens. Vertical attachment tolerance: + 15°/- 30°.
2PF 004 081-001	2	Position light with black base plate
2PF 004 081-007	50	
2PF 004 081-017	50	Position light with white base plate

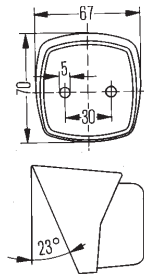

		For front mounting. Clear lens. For mounting on surfaces inclined at 23°.
2PF 004 081-107	1	Position light with black base plate
		Accessories: C5W bulb,
8GM 002 092-121	10	12V
8GM 002 092-241	10	24V

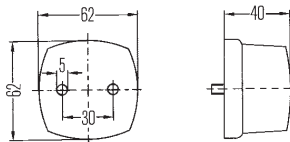

		For horizontal rear/side surface mounting Front lens clear, rear lens red. Black base plate.
2XS 005 639-001	24	Clearance light
2XS 005 639-002	1	Clearance light Pro-fit pack
		Accessories: C5W bulb,
8GM 002 092-121	10	12V
8GM 002 092-241	10	24V

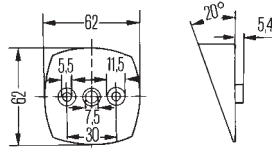

		Adapter white, for surface mounting of lights in model ranges 2PF 004 081-... and 2PF 003 057-... to body work surfaces inclined at 20°
9XD 127 264-007	50	Adapter

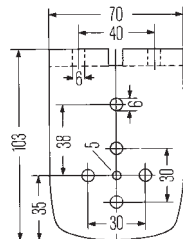

		Holder, black, for position lights in model ranges 2PF 003 057-..., 2PF 004 081-... or reflectors in model ranges 8RA 002 014-... and 8RA 002 015-...
8HG 003 799-001	2	Rubber holder
8HG 003 799-007	100	
8HG 003 799-017	1	Hard rubber holder

Combinable lights

003 014 series



For horizontal or vertical surface mounting

Black plastic base plate.
Two holes for M4 fixing screws. With grommet.

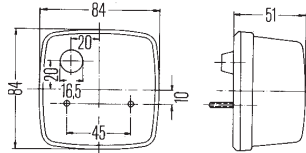
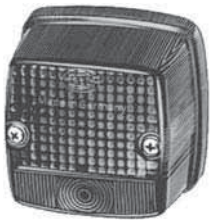

Part no.	Pk.	
		Red lens.
2SB 003 014-151	2	Rear-stop light
9EL 115 003-035	2	Spare parts: Lens with screws
		Red lens, with illumination for 340 x 240 mm and 240 x 130 mm licence plates (above licence plates), or mounting to right and left of 520 x 120 mm licence plate.
2ST 003 014-141	2	Rear-stop-licence plate light
9EL 115 003-021	2	Spare parts: Lens with screws
		Red rear light, amber indicator light.
2SW 003 014-131	2	Rear-indicator light
9EL 115 003-011	2	Spare parts: Lens with screws
		Red rear light, amber indicator light, with illumination for 340 x 240 mm and 240 x 130 mm licence plates (above licence plates), or mounting to right and left of 520 x 110 mm licence plate.
2SY 003 014-121	2	Rear-indicator-licence plate light
9EL 115 003-001	2	Spare parts/Accessories: Lens with screws
8GM 002 092-121	10	C5W bulb, 12V
8GM 002 092-241	10	24V
8GA 002 073-121	10	P21W bulb, 12V
8GA 002 073-241	10	24V
		For horizontal surface mounting.
		Red lens. Two lights can be fitted next to each other.
2SA 003 014-051	2	Rear light
9EL 110 540-001	1	Spare parts/Accessories: Lens with screws
8GM 002 092-121	10	C5W bulb, 12V
8GM 002 092-241	10	24V
		For horizontal surface mounting.
		Red lens.
2DA 003 014-031	2	Stop light
2DA 003 014-037	36	
		Accessories: P21W bulb,
8GA 002 073-121	10	12V
8GA 002 073-241	10	24V

For horizontal surface mounting

Black plastic base plate.
Two holes for M4 fixing screws. With grommet.

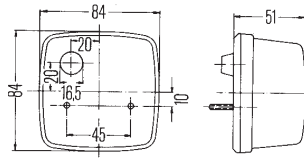

Part no.	Pk.	
		Clear lens.
2PF 003 014-071	2	Position light for front mounting
		Spare parts/Accessories:
9EL 110 542-001	3	Lens with screws
8GM 002 092-121	10	C5W bulb, 12V
8GM 002 092-241	10	24V
		Green lens.
		Vehicles whose trailers are equipped with ABS and do not yet have plug connectors to ISO 3731 (24S), ISO 7683 or ISO 1185 (24N) are required to equip the trailer with a green position light located in the field of vision of the outside mirror on the driver side for indicating the function of the ABS.
2PF 003 014-301	1	Position light
		Accessories:
8GA 002 073-121	10	P21W bulb, 12V
8GA 002 073-241	10	24V
		Amber indicator light, white position light.
2BE 003 014-251	2	Indicator-position light for front mounting
2BE 003 014-257	36	
		Spare parts/Accessories:
9EL 115 003-055	2	Lens with screws
8GM 002 092-121	10	C5W bulb, 12V
8GM 002 092-241	10	24V
8GA 002 073-121	10	P21W bulb, 12V
8GA 002 073-241	10	24V
		Amber lens.
2BA 003 014-111	2	Indicator light for front mounting (category 1)
2BA 003 014-011	2	Indicator light for rear mounting (category 2a)
		Spare parts/Accessories:
9EL 110 536-011	3	Lens with screws for -111
9EL 110 536-001	1	for -011
8GA 002 073-121	10	P21W bulb, 12V
8GA 002 073-241	10	24V
		Clear lens.
2ZR 003 014-091	2	Reverse light
		Accessories:
9EL 110 544-001	1	Lens with screws
8GA 002 073-121	10	P21W bulb, 12V
8GA 002 073-241	10	24V

Combinable lights

996 012 series



For horizontal surface mounting

Black plastic body.
Two M5 fixing screws. With grommet.

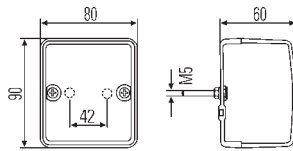

Part no.	Pk.	
		Red lens.
2SA 996 012-091	2	Rear light
		Spare parts/Accessories:
8GA 002 071-131	10	R10W bulb, 12V
8GA 002 071-251	10	24V
		Red lens.
2DA 996 012-041	2	Stop light
		Red lens.
		With 2 rubber spacers for 8° or 12° inclination.
2NE 996 012-021	2	Rear fog light
		Accessories:
8GA 002 073-121	10	P21W bulb, 12V
8GA 002 073-241	10	24V
		Clear lens.
2PF 996 012-051	2	Position light
		Accessories:
8GA 002 071-121	10	R5W bulb, 12V
8GA 002 071-241	10	24V
		For rear or front surface mounting.
		Amber lens.
2BA 996 012-061	2	Indicator light
2BA 996 012-071	1	Indicator light with rubber spacer for 8° inclination
2BA 996 012-147	45	Indicator light with PMMA lens, 24V bulb, 500 mm long lead and plug
		Clear lens.
2ZR 996 012-111	2	Reverse light with 2 rubber spacers for 8° or 12° inclination
2ZR 996 012-101	1	Reverse light without rubber spacers
2JB 996 012-121	1	Boot light with switch and rubber spacers
		Spare parts/Accessories:
9EL 990 034-041	1	Lens for 2BA ...
8GA 002 073-121	10	P21W bulb, 12V
8GA 002 073-241	10	24V

For horizontal or vertical flush/surface mounting, also changeable against bulb version of 003 236 series

In LED-technology. Clear lens.
With 6 LEDs per function, 100 mm lead with blade type contacts 6.3 mm, polarity reversal protection and grommet.
All lights are suitable ADR.
 Black plastic body.
 Two M6 fixing screws. See LED instruction 2, 3.

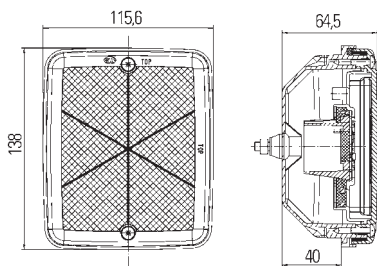

Part no.	Pk.	
		For horizontal or vertical flush/surface mounting. Consumption: 0.03A at 12V, 0.008A at 24V.
2SA 013 236-041	1	Rear light, 12V0.3W
2SA 013 236-241	1	Rear light, 24V0.2W
		For surface/flush mounting. Rear light: 0.3W at 12V, 0.2W at 24V, stop light: 1.5W at 12V, 1.2W at 24V. Consumption: rear light: 0.03A at 12V, 0.008A at 24V, stop light: 0.13A bei 12V, 0.05A at 24V.
2SB 013 236-071	1	Rear-stop light, 12V
2SB 013 236-271	1	Rear-stop light, 24V
		For horizontal or vertical flush/surface mounting. Consumption: 0.13A at 12V, 0.05A at 24V.
2DA 013 236-031	1	Stop light, 12V1.5W
2DA 013 236-231	1	Stop light, 24V1.2W
		For horizontal or vertical flush/surface mounting. Consumption: 0.11A at 12V, 0.05A at 24V.
2BA 013 236-011	1	Indicator light without pulse for indicator failure check, 12V1.3W
2BA 013 236-211	1	Indicator light without pulse for indicator failure check, 24V1.3W
2BA 013 236-021	1	Indicator light with pulse for indicator failure check, 12V1.3W
2BA 013 236-221	1	Indicator light with pulse for indicator failure check, 24V1.3W
		Spare parts:
9DW 195 804-041	1	Rear light module, 12V
9DW 195 804-241	1	Rear light module, 24V
9DW 195 804-071	1	Rear-stop light module, 12V
9DW 195 804-271	1	Rear-stop light module, 24V
9DW 195 804-031	1	Stop light module, 12V
9DW 195 804-231	1	Stop light module, 24V
9DW 195 804-011	1	Indicator light module without pulse for indicator failure check, 12V
9DW 195 804-211	1	Indicator light module without pulse for indicator failure check, 24V
9DW 195 804-021	1	Indicator light module with pulse for indicator failure check, 12V
9DW 195 804-221	1	Indicator light module with pulse for indicator failure check, 24V

Combinable lights

013 236 series



For horizontal or vertical flush/surface mounting, also changeable against bulb version of 003 236 series

**In LED-technology. Clear lens.
With 6 LEDs, 100 mm long lead with 6.3 mm blade terminals, polarity reversal protection and grommet.
All lights are suitable ADR.**



Black plastic body. Two M6 fixing screws.
See LED instruction 2.

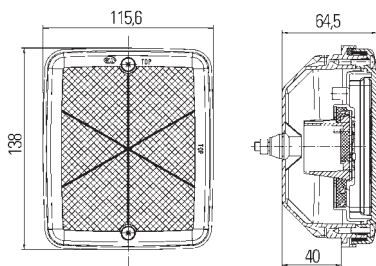

Part no.	Pk.	
		For horizontal or vertical flush/surface mounting. Consumption: 0.2A at 12V, 0.1A at 24V.
2NE 013 236-001	1	Rear fog light, 12V2.4W
2NE 013 236-201	1	Rear fog light, 24V2.4W
		Spare parts: Rear fog light module,
9DW 195 804-001	1	12V
9DW 195 804-201	1	24V
		Consumption: 0.17A at 12V, 0.09A at 24V.
2ZR 013 236-051	1	Reverse light for horizontal flush/surface mounting, 12V2.0W
2ZR 013 236-251	1	Reverse light for horizontal flush/surface mounting, 24V2.0W
		Reverse light for vertical flush/surface mounting, 12V2.0W
2ZR 013 236-061	1	Reverse light for vertical flush/surface mounting, 12V2.0W
2ZR 013 236-261	1	Reverse light for vertical flush/surface mounting, 24V2.0W
		Spare parts: Reverse light module,
9DW 195 804-051	1	12V, for -051
9DW 195 804-251	1	24V, for -251
9DW 195 804-061	1	12V, for -061
9DW 195 804-261	1	24V, for -261

**For horizontal or vertical flush mounting,
also changeable against bulb version
of 003 236 series**

In LED-technology. Clear lens.
With 6 LEDs per function, 100 mm lead with blade type
contacts 6.3 mm,
polarity reversal protection and grommet.
All lights are suitable ADR.
Black rubber body.
Two M6 fixing screws. See LED instruction 2, 3, 4.

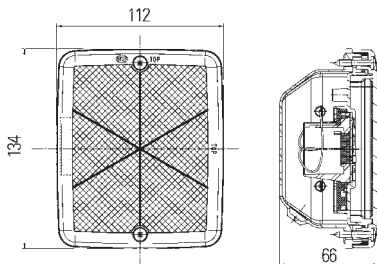

Part no.	Pk.	
		For horizontal or vertical flush mounting. Consumption: 0.03A at 12V, 0.008A at 24V.
2SA 013 236-161	1	Rear light, 12V0.3W
2SA 013 236-361	1	Rear light, 24V0.2W
		Spare parts: Rear light module,
9DW 195 804-041	1	12V
9DW 195 804-241	1	24V
		For vertical flush mounting. Rear light: 0.3W at 12V, 0.2W at 24V, stop light: 1.5W at 12V, 1.2W at 24V. Consumption: rear light: 0.03A at 12V, 0.008A at 24V, stop light: 0.13A bei 12V, 0.05A at 24V.
2SB 013 236-171	1	Rear-stop light, 12V
2SB 013 236-371	1	Rear-stop light, 24V
		Spare parts: Rear-stop light module,
9DW 195 804-071	1	12V
9DW 195 804-271	1	24V
		For vertical flush mounting. Rear light: 0.3W at 12V, 1.4W at 24V, indicator light: 1.2W at 12V, 1.4W at 24V. Consumption: rear light: 0.03A at 12V, 0.006A at 24V, indicator light: 0.10A at 12V, 0.06A at 24V.
2BA 013 236-181	1	Rear-indicator light without pulse for indicator failure check, 12V
2BA 013 236-381	1	Rear-indicator light without pulse for indicator failure check, 24V
2BA 013 236-191	1	Rear-indicator light with pulse for indicator failure check, 12V
2BA 013 236-391	1	Rear-indicator light with pulse for indicator failure check, 24V
		Spare parts: Rear-indicator light module without pulse for indicator failure check,
9DW 195 804-181	1	12V
9DW 195 804-381	1	24V
		Rear-indicator light module with pulse for indicator failure check,
9DW 195 804-191	1	12V
9DW 195 804-391	1	24V
		For vertical flush mounting. Consumption: 0.13A at 12V, 0.05A at 24V.
2DA 013 236-151	1	Stop light, 12V1.5W
2DA 013 236-351	1	Stop light, 24V1.2W
		Spare parts: Stop light module,
9DW 195 804-031	1	12V
9DW 195 804-231	1	24V

Combinable lights

013 236 series



For horizontal or vertical flush mounting, also changeable against bulb version of 003 236 series

In LED-technology. Clear lens.
With 6 LEDs, 100 mm long lead with 6.3 mm blade terminals, polarity reversal protection and grommet.
All lights are suitable ADR.



Black rubber body.
 Two M6 fixing screws. See LED instruction 2, 3, 4.

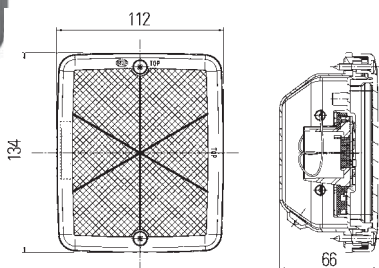

Part no.	Pk.	
		For horizontal or vertical flush mounting. Consumption: 0.11A at 12V, 0.05A at 24V.
2BA 013 236-131	1	Indicator light without pulse for indicator failure check, 12V1.3W
2BA 013 236-331	1	Indicator light without pulse for indicator failure check, 24V1.3W
2BA 013 236-141	1	Indicator light with pulse for indicator failure check, 12V1.3W
2BA 013 236-341	1	Indicator light with pulse for indicator failure check, 24V1.3W
		For horizontal or vertical flush mounting. Consumption: 0.2A at 12V, 0.1A at 24V.
2NE 013 236-001	1	Rear fog light, 12V2.4W
2NE 013 236-201	1	Rear fog light, 24V2.4W
		For horizontal or vertical flush mounting. Consumption: 0.17A at 12V, 0.09A at 24V.
2ZR 013 236-111	1	Reverse light for horizontal flush mounting, 12V2.0W
2ZR 013 236-311	1	Reverse light for horizontal flush mounting, 24V2.0W
2ZR 013 236-121	1	Reverse light for vertical flush mounting, 12V2.0W
2ZR 013 236-321	1	Reverse light for vertical flush mounting, 24V2.0W
		Spare parts:
9DW 195 804-011	1	Indicator light module without pulse for indicator failure check, 12V
9DW 195 804-211	1	Indicator light module without pulse for indicator failure check, 24V
9DW 195 804-021	1	Indicator light module with pulse for indicator failure check, 12V
9DW 195 804-221	1	Indicator light module with pulse for indicator failure check, 24V
9DW 195 804-001	1	Rear fog light module, 12V
9DW 195 804-201	1	Rear fog light module, 24V
9DW 195 804-051	1	Reverse light module, 12V, for -111
9DW 195 804-251	1	Reverse light module, 24V, for -311
9DW 195 804-061	1	Reverse light module, 12V, for -121
9DW 195 804-261	1	Reverse light module, 24V, for -321

Accessories

Combination possibilities rubber housing with LED-single modules.
All lights are suitable ADR.

Also suitable for conversion of the light series
004 431 / 004 432.

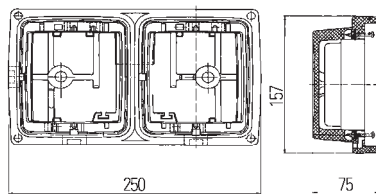
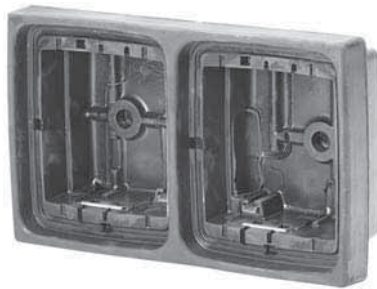
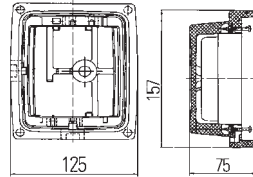
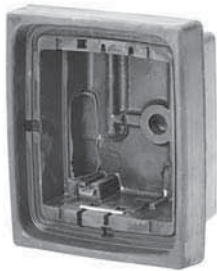

Part no.	Pk.	
9BG 128 652-021	1	Rubber body combined with
9BG 128 652-011	1	Double-rubber body combined with
9DW 195 804-071	1	Rear-stop light module, 12V
9DW 195 804-181	1	Indicator light module without indicator failure check, 12V
9DW 195 804-071	1	Rear-stop light module, 12V
9DW 195 804-191	1	Indicator light module with indicator failure check, 12V
9DW 195 804-271	1	Rear-stop light module, 24V
9DW 195 804-381	1	Indicator light module without indicator failure check, 24V
9DW 195 804-271	1	Rear-stop light module, 24V
9DW 195 804-391	1	Indicator light module with indicator failure check, 24V
9DW 195 804-041	1	Rear light module, 12V
9DW 195 804-181	1	Indicator light module without indicator failure check, 12V
9DW 195 804-041	1	Rear light module, 12V
9DW 195 804-191	1	Indicator light module with indicator failure check, 12V
9DW 195 804-241	1	Rear light module, 24V
9DW 195 804-381	1	Indicator light module without indicator failure check, 24V
9DW 195 804-241	1	Rear light module, 24V
9DW 195 804-391	1	Indicator light module with indicator failure check, 24V
9DW 195 804-061	1	Reverse light module, 12V
9DW 195 804-001	1	Rear fog light module, 12V
9DW 195 804-261	1	Reverse light module, 24V
9DW 195 804-201	1	Rear fog light module, 24V

Combinable lights

003 236 series



For horizontal or vertical flush/surface mounting

Black plastic body. Two M6 fixing screws.

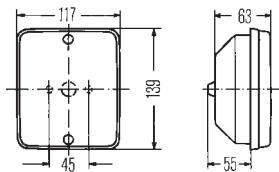

Part no.

Pk.

Red lens.

2SA 003 236-041

1

Rear light

2SA 003 236-047

6

2SA 003 236-048

48

9EL 120 201-001

4

Spare parts/Accessories:

Lens

R5W bulb,

12V

8GA 002 071-121

10

8GA 002 071-241

10

24V

Red lens.

2DA 003 236-031

1

Stop light

2DA 003 236-037

6

9EL 119 544-031

4

Spare parts/Accessories:

Lens

P21W bulb,

12V

8GA 002 073-121

10

8GA 002 073-241

10

24V

Red lens.

2NE 003 236-001

1

Rear fog light

2NE 003 236-008

48

9EL 119 544-001

4

Spare parts/Accessories:

Lens

Reflector

P21W bulb,

12V

8GA 002 073-121

10

8GA 002 073-241

10

24V

Amber lens.

2BA 003 236-021

1

Indicator light for rear (category 2a)

or (as auxiliary light)

side mounting (category 5)

2BA 003 236-027

6

9EL 119 544-021

4

Spare parts/Accessories:

Lens for -021/-027

P21W bulb,

12V

8GA 002 073-121

10

8GA 002 073-241

10

24V

Clear lens.

2ZR 003 236-051

1

Reverse light

2ZR 003 236-057

48

9EL 119 544-111

4

Spare parts/Accessories:

Lens

P21W bulb,

12V

8GA 002 073-121

10

8GA 002 073-241

10

24V



For horizontal or vertical flush/surface mounting

Black rubber body. Mounting depth: 44 mm.

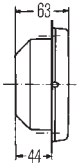
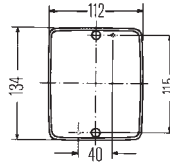

Part no.	Pk.	
2SA 003 236-341	1	Red lens. Two BZ4.2 fixing screws.
		Rear light
9EL 120 201-001	4	Spare parts/Accessories: Lens
8GA 002 071-121	10	R5W bulb,
8GA 002 071-241	10	12V
		24V
		Red lens. Two BZ4.2 fixing screws.
2DA 003 236-331	1	Stop light
		Spare parts/Accessories:
9EL 119 544-031	4	Lens
8GA 002 073-121	10	P21W bulb,
8GA 002 073-241	10	12V
		24V
		Red lens. Two BZ4.2 fixing screws.
2NE 003 236-301	1	Rear fog light
		Spare parts/Accessories:
9EL 119 544-001	4	Lens
8GA 002 073-121	10	P21W bulb,
8GA 002 073-241	10	12V
		24V
		Amber lens. For rear or (as auxiliary light) side mounting (category 2a and 5).
2BA 003 236-321	1	Indicator light
		Spare parts/Accessories:
9EL 119 544-021	4	Lens
8GA 002 073-121	10	P21W bulb,
8GA 002 073-241	10	12V
		24V
		For vertical mounting. Red-amber lens. Two holes for M4 x 25 fixing screws.
2BA 003 236-541	1	Indicator-clearance light also indicator-rear light
		Spare parts/Accessories:
9EL 119 544-212	4	Lens with screws
8GA 002 071-131	10	R10W bulb,
8GA 002 071-251	10	12V
		24V
8GA 002 073-121	10	P21W bulb,
8GA 002 073-241	10	12V
		24V
		Clear lens. Two BZ4.2 fixing screws.
2ZR 003 236-311	1	Reverse light
		Spare parts/Accessories:
9EL 119 544-111	4	Lens
8GA 002 073-121	10	P21W bulb,
8GA 002 073-241	10	12V
		24V



Combinable lights

005 200 series



For horizontal or vertical flush/surface mounting

With double reflector for two bulbs.

Black plastic body.

Four 4.2 x 16 fixing screws.

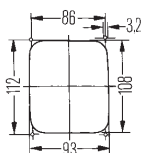
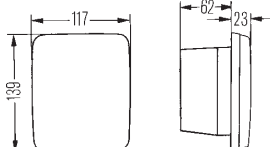

Part no.	Pk.	
2SA 005 200-331	6	Red lens.
		Rear light
		Accessories:
8GA 002 071-131	10	R10W bulb, 12V
8GA 002 071-251	10	24V
2DA 005 200-321	6	Red lens.
		Stop light
		Accessories:
8GA 002 073-121	10	P21W bulb, 12V
8GA 002 073-241	10	24V
2BA 005 200-311	6	Amber lens (category 2a).
		Indicator light
		Accessories:
8GA 002 073-121	10	P21W bulb, 12V
8GA 002 073-241	10	24V
2ZR 005 200-301	1	Clear lens.
		Reverse light
		Accessories:
8GA 002 073-121	10	P21W bulb, 12V
8GA 002 073-241	10	24V

For horizontal or vertical flush/surface mounting

For surface mounting: two M8 fixing screws.
 For flush mounting: four holes for fixing screws.
 Depth required for flush mounting: 45 mm. Black rubber body.



Part no.	Pk.	
		Red rear and stop light, amber indicator light.
2SD 004 431-011	1	Rear-stop-indicator light
		Spare parts/Accessories:
		Lens
9EL 119 544-101	4	for rear/stop light
9EL 119 544-021	4	for indicator light
		Reflector
9DE 128 658-001	2	for two bulbs
9DE 128 657-001	2	for one bulb
		R10W bulb,
8GA 002 071-131	10	12V
8GA 002 071-251	10	24V
		P21W bulb,
8GA 002 073-121	10	12V
8GA 002 073-241	10	24V

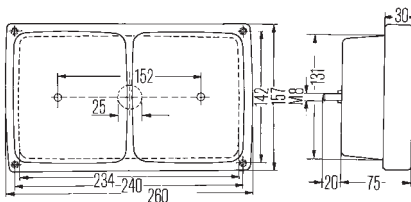

		Red stop light, amber indicator light.
2DB 004 431-061	1	Stop-indicator light
		Spare parts/Accessories:
		Lens
9EL 119 544-031	4	for stop light
9EL 119 544-021	4	for indicator light
9DE 128 657-001	2	Reflector for 1 bulb
		R10W bulb,
8GA 002 071-131	10	12V
8GA 002 071-251	10	24V
		P21W bulb,
8GA 002 073-121	10	12V
8GA 002 073-241	10	24V



		Red rear and rear fog light.
		2 bulbs for rear light.
2SA 004 431-071	1	Rear-rear fog light
		Spare parts/Accessories:
9EL 119 544-001	4	Lens for rear fog light
		R10W bulb,
8GA 002 071-131	10	12V
8GA 002 071-251	10	24V
		P21W bulb,
8GA 002 073-121	10	12V
8GA 002 073-241	10	24V

Combinable lights

004 432 series - 008 982 series



For horizontal or vertical flush/surface mounting

For surface mounting: two M8 fixing screws.
For flush mounting: four holes for fixing screws.
Depth required for flush mounting: 45 mm. Black rubber body.

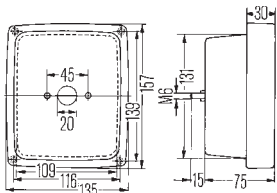

Part no.	Pk.	
Red lens.		
2NE 004 432-011	1	Rear fog light
Spare parts/Accessories:		
9EL 119 544-001	4	Lens
8GA 002 073-121	10	P21W bulb, 12V
8GA 002 073-241	10	P21W bulb, 24V
Clear lens.		
2ZR 004 432-001	1	Reverse light
Spare parts/Accessories:		
9EL 119 544-111	4	Lens
8GA 002 073-121	10	P21W bulb, 12V
8GA 002 073-241	10	P21W bulb, 24V

For horizontal flush mounting

In LED-technology. With 32 LEDs.

Grey plastic body.
With 450 mm long lead with stripped ends.

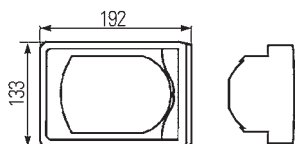
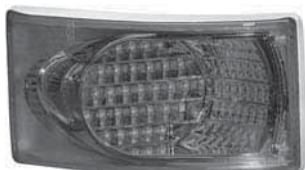

Part no.	Pk.	
Red lens, without optical pattern. Consumption: 0.13A at 24V. See LED instruction 2.		
2SB 008 982-001	1	Rear-stop light, 24V3.0W
2SB 008 982-007	36	
Red light. Clear lens, without optical pattern. Consumption: 0.25A at 12V. See LED instruction 2.		
2SB 008 982-367	36	Rear-stop light, 12V3.0W
For front mounting. Amber light. Clear lens, without optical pattern. With failure check for LED indicators. Consumption: 0.17A at 12V, 0.08A at 24V. See LED instruction 3.		
2BA 008 982-341	1	Indicator light, 12V3.0W
2BA 008 982-347	36	
For front mounting. Amber light. Clear lens without optical pattern. With failure check for LED indicators. Consumption: 0.17A at 12V, 0.08A at 24V. See LED instruction 3.		
2BA 008 982-347	36	
2BA 008 982-041	1	Indicator light, 24V2.0W
2BA 008 982-047	36	

For vertical flush mounting

With 12V bulb.
 Grey plastic body, with optical pattern.
 With seal.

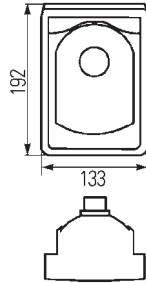

Part no.	Pk.	
		Red lens, without optical pattern. With 3-pole AMP-Superseal plug connector.
2SB 008 805-201	1	Rear-stop light
		Spare parts: P21/5W bulb, 12V
8GD 002 078-121	10	
<hr/>		
		For rear mounting (category 2a). Clear lens, without optical pattern. With 3-pole AMP-Superseal plug connector. Two lights can be fitted next to each other.
2BA 008 805-211	1	Indicator light
		Spare parts: PY21W bulb, 12V
8GA 006 841-121	10	

Combinable lights

008 805 series



For horizontal flush mounting

Grey plastic body, with optical pattern.

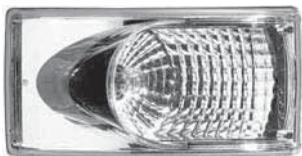
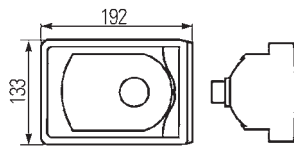
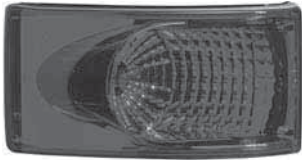

Part no.	Pk.	
		Red lens, without optical pattern.
2SB 008 805-021	1	Rear-stop light
2SB 008 805-027	36	
2SB 008 805-237	36	Rear-stop light with 12V bulb
		Spare parts/Accessories:
8GD 002 078-121	10	P21/5W bulb, 12V
8GD 002 078-241	10	24V
9GD 159 740-007	1	Self-adhesive gasket, black
		Red lens, without optical pattern.
2SA 008 805-001	1	Rear light
2SA 008 805-007	36	
		Accessories:
8GA 002 071-121	10	R5W bulb, 12V
8GA 002 071-241	10	24V
9GD 159 740-007	1	Self-adhesive gasket, black
		Red lens, without optical pattern.
2DA 008 805-011	1	Stop light
2DA 008 805-017	36	
		Accessories:
8GA 002 073-121	10	P21W bulb, 12V
8GA 002 073-241	10	24V
9GD 159 740-007	1	Self-adhesive gasket, black
		For rear or front mounting.
		Clear lens, without optical pattern.
2BA 008 805-051	1	Indicator light
2BA 008 805-057	36	
2BA 008 805-257	36	Indicator light with 12V bulb
		Spare parts/Accessories:
8GA 006 841-121	10	PY21W bulb, 12V
8GA 006 841-241	10	24V
9GD 159 740-007	1	Self-adhesive gasket, black
		For rear or front mounting.
		Amber lens, without optical pattern.
2BA 008 805-187	36	Indicator light
		Red lens, without optical pattern.
2NE 008 805-031	1	Rear fog light
2NE 008 805-037	36	
		Clear lens, without optical pattern.
2ZR 008 805-041	1	Reverse light
2ZR 008 805-047	36	
2ZR 008 805-247	36	Reverse light with 12V bulb
		Spare parts/Accessories:
8GA 002 073-121	10	P21W bulb, 12V
8GA 002 073-241	10	24V
9GD 159 740-007	1	Self-adhesive gasket, black

For horizontal flush mounting

Four holes for B4.2 x 13 fixing screws.

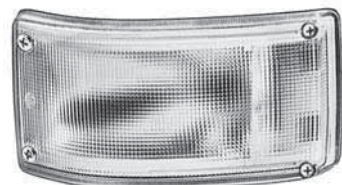
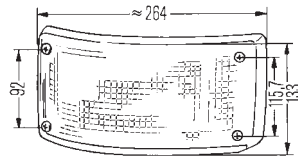

Part no.	Pk.	
2SA 005 603-021 2SA 005 603-027	1 32	Red lens. Two lights can be fitted next to each other. Rear light
8GA 002 071-121 8GA 002 071-241	10 10	Accessories: R5W bulb, 12V 24V
2SB 005 603-137	1	Red lens. Rear-stop light
8GD 002 078-121 8GD 002 078-241	10 10	Accessories: P21/5W bulb, 12V 24V
2DA 005 603-031 2DA 005 603-037	1 32	Red lens. Two lights can be fitted next to each other. Stop light
2NE 005 603-071 2NE 005 603-077	1 32	Red lens. Rear fog light
2BA 005 603-011 2BA 005 603-017	1 32	For rear mounting (category 2a). Amber lens. Indicator light
2BA 005 603-001 2BA 005 603-007	1 32	For front or side mounting (category 1a and 5). Amber lens. Indicator light
2BA 005 603-117	1	For rear mounting (category 2a). Red lens. Indicator light with filter
2ZR 005 603-061 2ZR 005 603-067	1 32	Clear lens. Reverse light
8GA 002 073-121 8GA 002 073-241	10 10	Accessories: P21W bulb, 12V 24V

Combinable lights

004 119 series



For horizontal flush mounting

Two holes for B4.2 x 28 fixing screws.

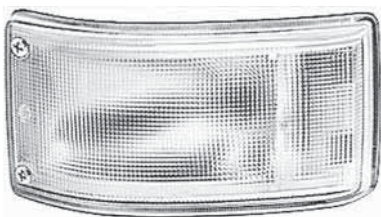
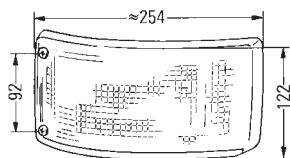

Part no.	Pk.	
2BA 004 119-001	1	Amber lens. Indicator light for front mounting (category 1 and 5) Accessories: P21W bulb, 10 12V 10 24V 10 24V (HD)
2BA 004 119-017	10	Clear lens. With base plate and grommet. Can be used only in combination with amber bulb PY21W (not supplied with lamp). Indicator light for front or side mounting (category 1 and 5) Spare parts/Accessories: Grommet PY21W bulb, 10 12V 10 24V
9GT 143 133-007 8GA 006 841-121 8GA 006 841-241	10 10 10	Clear lens. With base and two grommets. With amber filter for indicator light.
2BE 004 119-021	1	Indicator-position light for front mounting (category 1 and 5) Spare parts/Accessories: Grommet 10 P21W bulb, 10 12V 10 24V 10 24V (HD) W5W bulb, 10 12V 10 24V
9GT 134 655-007 9GT 143 133-007 8GA 002 073-121 8GA 002 073-241 8GA 002 073-251 8GP 003 594-121 8GP 003 594-241	10 10 10 10 10 10 10	

For horizontal or vertical flush mounting

Two holes for B4.2 x 13 fixing screws. With grommet.

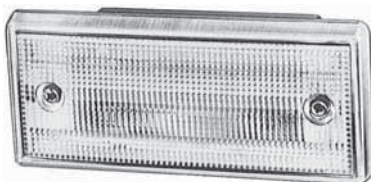
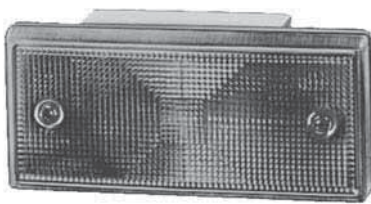
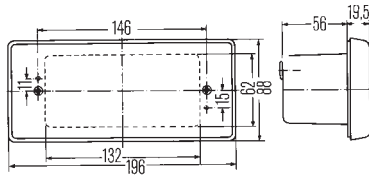
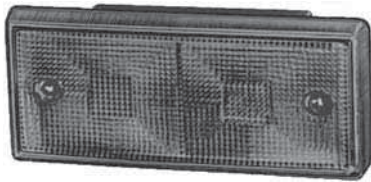

Part no.	Pk.	
2SA 003 734-121	1	Red lens. Two bulbs connected in parallel. (not supplied with lamp).
		Rear light
		Spare parts/Accessories:
9EL 135 060-001	2	Lens with screws
8GA 002 071-121	10	R5W bulb,
8GA 002 071-241	10	12V
		24V
2DA 003 734-011	1	Red lens. For 1 bulb.
		Stop light
		Spare parts/Accessories:
9EL 123 632-001	2	Lens with screws
8GA 002 073-121	10	P21W bulb,
8GA 002 073-241	10	12V
		24V
2NE 003 734-091	1	Red lens. For 1 bulb. For horizontal flush mounting.
		Rear fog light
		Accessories:
8GA 002 073-121	10	P21W bulb,
8GA 002 073-241	10	12V
		24V
2ZR 003 734-041	1	Clear lens. Two bulbs connected in parallel. For horizontal flush mounting.
		Reverse light
		Spare parts/Accessories:
9EL 123 635-001	2	Lens with screws
8GA 002 073-121	10	P21W bulb,
8GA 002 073-241	10	12V
		24V

Combinable lights

003 734 series



For horizontal or vertical flush mounting

Two holes for B4.2 x 13 fixing screws. With grommet.

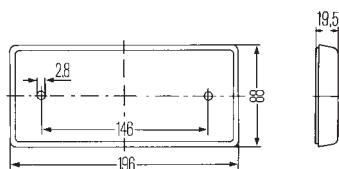
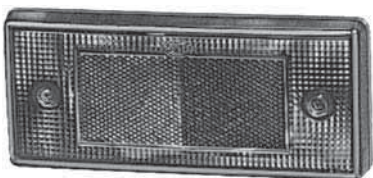
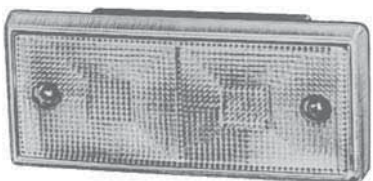
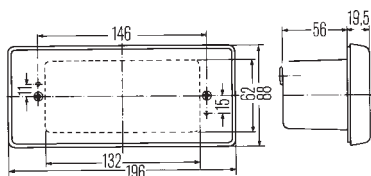
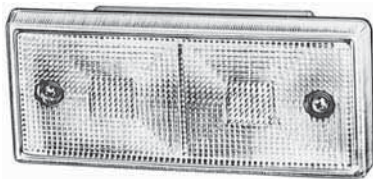

Part no.	Pk.	
2PF 003 734-031	1	Clear lens. Two bulbs connected in parallel (not supplied with lamp).
		Position light for front mounting
		Accessories: R5W bulb, 10 12V 10 24V
8GA 002 071-121	10	
8GA 002 071-241	10	
2BA 003 734-001	1	Amber lens. Two bulbs connected in parallel. For horizontal flush mounting.
		Indicator light for rear mounting (category 2a)
		Accessories: P21W bulb, 10 12V 10 24V
8GA 002 073-121	10	
8GA 002 073-241	10	
2BA 003 734-061	1	Amber lens. For 1 bulb.
		Indicator light for front mounting (category 1)
		Accessories: P21W bulb, 10 12V 10 24V
8GA 002 073-121	10	
8GA 002 073-241	10	
8RA 003 734-101	1	Red, reflecting surface 54 sq. cm. With rubber base plate. Two B3.9 x 22 fixing screws. For horizontal or vertical surface mounting.
		Reflectors

For horizontal or vertical flush mounting

Plastic base plate.
Two 4 mm dia. holes for fixing screws.

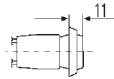
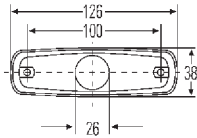

Part no.	Pk.	
		For rear mounting. Red lens, without reflector.
2SA 962 964-091	1	Rear light with 24V bulb and red base plate
		Spare parts/Accessories: W5W bulb,
8GP 003 594-121	10	12V
8GP 003 594-241	10	24V
9GD 963 281-001	1	Gasket
9GT 963 129-001	1	Grommet
		For front mounting. Clear lens, without reflector.
2PF 962 964-061	1	Position light with 12V bulb and white base plate for wavy outer surfaces
2PF 962 964-071	1	Position light with 12V bulb and clear base plate, for flat outer surfaces
		Clear lens, with reflector.
2PG 962 964-041	1	Position light with 12V bulb and white base plate for wavy outer surfaces
2PG 962 964-051	1	Position light with 12V bulb and clear base plate, for flat outer surfaces
2PG 962 964-057	160	
		For side mounting. Amber lens, with reflector.
2PS 962 964-031	1	Side-marker light with 12V bulb and white base plate for wavy outer surfaces
2PS 962 964-037	160	
2PS 962 964-012	1	Side-marker light with 12V bulb and clear base plate, for flat outer surfaces
2PS 962 964-018	160	
		Spare parts/Accessories: W3W bulb,
8GP 003 594-141	10	12V
8GP 003 594-241	10	24V
9GD 963 281-001	1	Gasket
9GT 963 129-001	1	Grommet

Combinable lights

006 717 series



For horizontal or vertical surface mounting

Black plastic body.
Two 5 mm dia. holes for fixing screws.

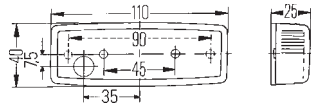

Part no.	Pk.	
		For rear mounting. Red lens. $\pm 10^\circ$ inclination.
2SA 006 717-001	1	Rear light
2SA 006 717-007	100	
9EL 141 135-001	20	Spare parts/Accessories: Lens
8GP 003 594-121	10	W5W bulb, 12V
2TM 006 717-047	1	Rear light with reflector
8GP 003 594-121	10	Accessories: W5W bulb, 12V
		For front mounting. Clear lens. Can be mounted either vertically or horizontally ($\pm 15^\circ$ inclination).
2PF 006 717-011	1	Position light
9EL 141 135-011	20	Spare parts/Accessories: Lens
8GP 003 594-121	10	W5W bulb, 12V
		For front mounting. Clear lens with reflector. Can be mounted either vertically or horizontally ($\pm 15^\circ$ inclination).
2PG 006 717-021	20	Position light with reflector
2PG 006 717-027	100	
9EL 141 135-021	20	Spare parts/Accessories: Lens
8GP 003 594-121	10	W5W bulb, 12V
		For side mounting. Amber lens with reflector.
2PS 006 717-031	20	Side-marker light with reflector
2PS 006 717-037	100	
2PS 006 717-032	1	Side-marker light with reflector Pro-fit-pack
		For side mounting. Amber lens with reflector.
2PS 006 717-051	8	Side-marker light with reflector, with adhesive foil for fixing
2PS 006 717-057	100	
2PS 006 717-071	20	Side-marker light with reflector, with closed fixing holes
2PS 006 717-077	100	
2PS 006 717-061	8	Side-marker light with reflector, with bracket for fixing below load surface
2PS 006 717-067	100	
9EL 141 135-031	1	Spare parts/Accessories: Lens
8GP 003 594-121	10	W5W bulb, 12V

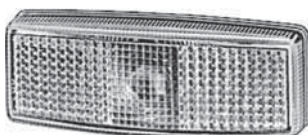

For horizontal surface mounting

Plastic base plate. Two holes for M5 fixing screws.
With plug connector.

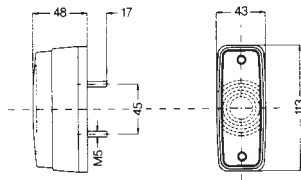

Part no.	Pk.	
		Red lens. Only for spare parts requirement.
2SA 997 027-001	1	Rear light
9EL 997 387-001	1	Spare parts/Accessories: Lens with screws
8GM 002 092-121	10	C5W bulb, 12V
8GM 002 092-121	10	24V
		Red lens.
2DA 997 027-021	1	Stop light
8GA 002 073-121	10	Accessories: P21W bulb, 12V
8GA 002 073-241	10	24V
		For front mounting. Amber lens.
2BA 997 027-031	1	Indicator light
8GA 002 073-121	10	Accessories: P21W bulb, 12V
8GA 002 073-241	10	24V
		For front mounting. Clear lens. Only for spare parts requirement.
2PF 997 027-011	1	Position light
8GM 002 092-121	10	Accessories: C5W bulb, 12V
8GM 002 092-241	10	24V
		Clear lens. Chrome-plated body, with switch.
2JA 997 027-051	1	Interior light
8GM 002 091-121	10	Accessories: K bulb, 12V
8GM 002 091-241	10	24V

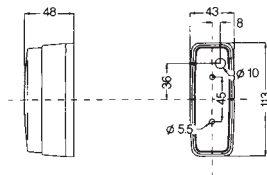

For surface mounting on towing vehicles and trailers

Myna Strip Lamp

In LED-technology. With 10 LEDs.

Clear Grilamid lens, black caps.

Consumption: 0.25A at 12V, 0.125A at 24V.

Two 4.2 mm dia. holes for fixing screws.

Type of protection: IP6K7, IP6K9K.

See LED instruction 2, 3.

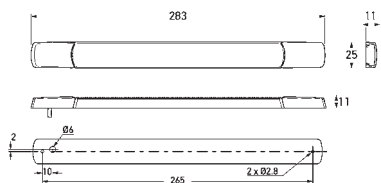

Part no.	Pk.	
		For horizontal or vertical surface mounting. With 300 mm long lead with stripped ends.
2SB 980 887-011	1	Rear-stop light, 12V3.0W
2SB 980 887-211	1	Rear-stop light, 24V3.0W
		For horizontal or vertical surface mounting. With 2500 mm long lead with stripped ends.
2DA 980 887-311	1	Stop light, 12V3.0W
2DA 980 887-411	1	Stop light, 24V3.0W
		For horizontal front mounting. With 2500 mm long lead with stripped ends. Without pulse for indicator failure check.
2BA 980 888-311	1	Indicator light, 12V3.0W
2BA 980 888-411	1	Indicator light, 24V3.0W
		For vertical front mounting. With 2500 mm long lead with stripped ends. Without pulse for indicator failure check.
2BA 980 888-511	1	Indicator light, 12V3.0W
2BA 980 888-611	1	Indicator light, 24V3.0W
		For horizontal or vertical rear surface mounting. With 2500 mm long lead with stripped ends. Without pulse for indicator failure check.
2BA 980 888-011	1	Indicator light, 12V3.0W
2BA 980 888-211	1	Indicator light, 24V3.0W
		Accessories:
9HD 980 885-008	4	Screw caps, white
9HD 980 885-018	4	Screw caps, carbon color
9HD 980 885-108	4	Screw caps, chrome-plated

For surface mounting on towing vehicles and trailers

Myna Strip Lamp

In LED-technology. With 10 LEDs.

Clear Grilamid lens, black caps.

Consumption: 0.25A at 12V, 0.125A at 24V.

Two 4.2 mm dia. holes for fixing screws.

Type of protection: IP6K7, IP6K9K.

See LED instruction 2, 3.

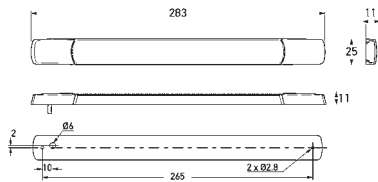

Part no.	Pk.	
		For horizontal or vertical surface mounting. With 2500 mm long lead with stripped ends.
2NE 980 889-501	1	Rear fog light, 12V3.0W
2NE 980 889-601	1	Rear fog light, 24V3.0W
		For horizontal surface mounting. With 2500 mm long lead with stripped ends.
2ZR 980 889-011	1	Reverse light, 12V3.0W
2ZR 980 889-211	1	Reverse light, 24V3.0W
		For vertical surface mounting. With 2500 mm long lead with stripped ends.
2ZR 980 889-111	1	Reverse light, 12V3.0W
2ZR 980 889-311	1	Reverse light, 24V3.0W
		For horizontal surface mounting. With 2500 mm long lead with stripped ends.
2PT 980 880-811	1	Daytime running light set with position light, 12V3.0W
2PT 980 880-861	1	Daytime running light set with position light, 24V3.0W
		Accessories:
9HD 980 885-008	4	Screw caps, white
9HD 980 885-018	4	carbon color
9HD 980 885-108	4	chrome-plated

Combinable lights

003 748 series



For surface mounting

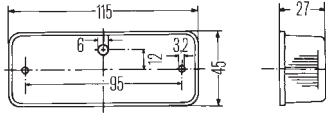

Part no.	Pk.	
		For horizontal or vertical surface mounting. Red lens. Black rubber base and two ST4.2 x 32 x 18 fixing screws.
2TM 003 748-011	4	Rear light with reflector
		Accessories: T4W bulb,
8GP 002 067-121	10	12V
8GP 002 067-241	10	24V

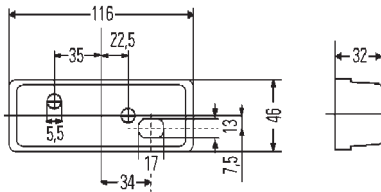

		For front horizontal surface mounting. Clear lens. With black plastic base plate and insert gasket. Two ST4.2 x 16 fixing screws. Type of protection: IP54K and IP59K.
2PG 003 748-151	4	Position light with reflector
		Spare parts/Accessories: Lens
9EL 148 274-001	2	T4W bulb,
8GP 002 067-121	10	12V
8GP 002 067-241	10	24V



		For side horizontal surface mounting. Amber lens. With black plastic base, inserted gasket and reinforced plate, four PT4 x 16 fixing screws and rubber mount.
2PS 003 748-121 2PS 003 748-127	4 80	Side-marker light with reflector
		Spare parts/Accessories: Lens
9EL 147 910-001	2	T4W bulb,
8GP 002 067-121	10	12V
8GP 002 067-241	10	24V

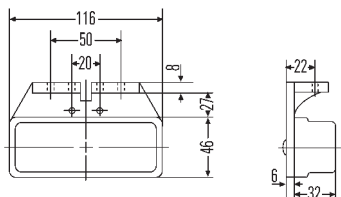
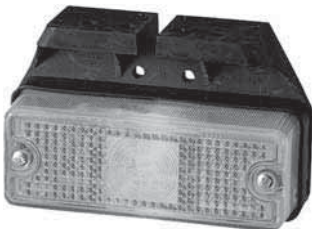

		For side horizontal surface mounting. Amber lens. With black plastic base, inserted gasket and reinforced plate, four PT4 x 16 fixing screws and rubber mount. Type of protection: IP54K and IP59K.
2PS 003 748-161 2PS 003 748-167	4 60	Side-marker light with reflector, holder mounting surfaces points towards the front
		Spare parts/Accessories: Lens
9EL 147 910-001	2	T4W bulb,
8GP 002 067-121	10	12V
8GP 002 067-241	10	24V

For horizontal or vertical surface mounting

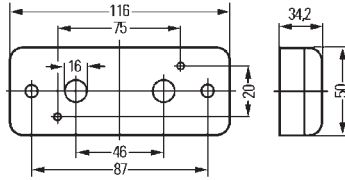

2PS 963 959-001
2PS 963 959-007

Pk.
4
50

For side mounting.

Amber lens.
With 2 PG screw connections.

Side-marker light with reflector

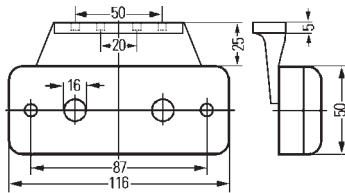

2PS 963 959-011
2PS 963 959-017

4
40

Side-marker light with reflector and rubber bracket

T4W bulb,
10 12V
10 24V
10 24V (HD)



2PG 963 959-021
2PG 963 959-027

4
50

For front mounting.

Clear lens.
With 1 PG screw connection.

Position light with reflector

Spare parts/Accessories:

Lens with screws
2
T4W bulb,
10 12V
10 24V
10 24V (HD)



2XS 963 959-031
2XS 963 959-037

4
50

For rear mounting.

Red lens.
With 1 PG screw connection.

Clearance light

Spare parts/Accessories:

Lens with screws
2
T4W bulb,
10 12V
10 24V
10 24V (HD)

Combinable lights

004 361 series



For horizontal or vertical surface mounting

Approved for vehicles carrying hazardous goods when diagonal 98 hole interval is used.

Base plate with black edge. With grommet.
Ten 5.5 mm dia. holes for fixing as required.

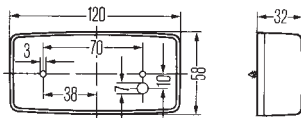
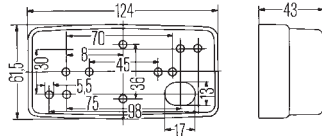

Part no.	Pk.	
		Red lens with reflector.
2TM 004 361-021	1	Rear light with reflector
		Spare parts/Accessories:
9EL 114 401-041	1	Lens with screws
8GA 002 071-121	10	R5W bulb, 12V
8GA 002 071-241	10	24V
<hr/>		
		Clear lens with reflector.
2PG 004 361-011	1	Position light with reflector
2PG 004 361-017	70	
		Spare parts/Accessories:
9EL 114 401-031	1	Lens with screws
8GA 002 071-121	10	R5W bulb, 12V
8GA 002 071-241	10	24V
<hr/>		
		Amber lens with reflector.
2PS 004 361-001	1	Side-marker light with reflector
2PS 004 361-007	70	
		Spare parts/Accessories:
9EL 114 401-001	1	Lens with screws
8GA 002 071-121	10	R5W bulb, 12V
8GA 002 071-241	10	24V

Black base plate.
Four 5.5 mm dia. holes for fixing screws.

Part no.	Pk.	
		Clear lens with reflector.
2PG 002 727-021	5	Position light with reflector
		Spare parts/Accessories:
8GM 002 092-121	10	C5W bulb, 12V
8GM 002 092-241	10	24V
<hr/>		
		Amber lens with reflector.
2PS 002 727-001	5	Side-marker light with reflector
		Spare parts/Accessories:
9EL 114 401-001	1	Lens with screws
8GM 002 092-121	10	C5W bulb, 12V
8GM 002 092-241	10	24V

For horizontal surface mounting

In LED-technology. With 2 LEDs.

Two 5.5 mm dia. holes for fixing screws. See LED instruction 2.

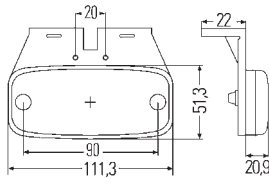
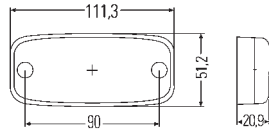

Part no.	Pk.	
		Red lens with reflector. Black base plate. Consumption: 0.02A at 12V, 0.04A at 24V.
2TM 345 600-307	20	Rear light with reflector and 5000 mm long lead, 12V0.5W
2TM 345 600-311	1	Rear light with reflector and 5000 mm long lead, 24V1.0W
2TM 345 600-317	20	
		Clear lens with reflector. White base plate. Consumption: 0.02A at 24V.
2PG 345 600-401	1	Position light with reflector and 500 mm long lead, 24V0.5W
2PG 345 600-411	1	Position light with reflector and 5000 mm long lead, 24V0.5W
		Amber lens with reflector. Black base plate. Consumption: 0.06A at 12V, 0.05A at 24V.
2PS 345 600-001	1	Side-marker light with reflector, without bracket, with 500 mm long lead, 12V0.7W
2PS 345 600-007	12	
2PS 345 600-011	1	Side-marker light with reflector, without bracket, with 500 mm long lead, 24V1.3W
2PS 345 600-017	12	
2PS 345 600-137	1	Side-marker light with reflector, without bracket, with 5000 mm long lead, 24V1.3W
2PS 345 600-147	1	Side-marker light with reflector, without bracket, with 10000 mm long lead, 24V1.3W
2PS 345 600-177	1	Side-marker light with reflector and bracket, with 1500 mm long lead and base, 24V1.3W
2PS 345 600-197	1	Side-marker light with reflector, without bracket, with 1500 mm long lead and Superseal plug, 24V1.3W
2PS 345 600-061	1	Side-marker light with reflector and bracket, with 500 mm long lead, 12V0.7W
2PS 345 600-067	20	
2PS 345 600-071	1	Side-marker light with reflector and bracket, with 500 mm long lead, 24V1.3W
2PS 345 600-077	20	
2PS 345 600-167	20	Side-marker light with reflector and bracket, with 1500 mm long lead, 24V1.3W
2PS 345 600-157	1	Side-marker light with reflector and bracket, with 1500 mm long lead and system plug, 24V1.3W
		Accessories:
9GD 341 063-007	20	Gasket

Combinable lights

345 600 series



For horizontal surface mounting

In LED-technology. With 2 LEDs.

All lights are suitable ADR.

Consumption: 0.05A at 24V.

Two 5.5 mm dia. holes for fixing screws.

See LED instruction 2.

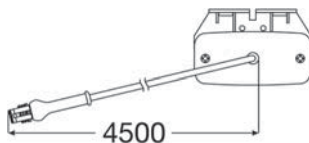
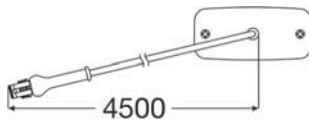
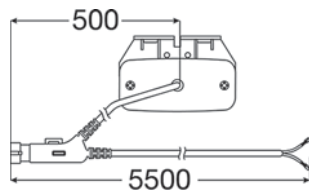
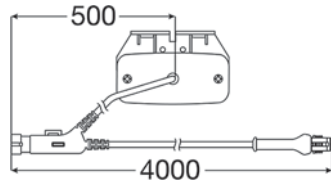
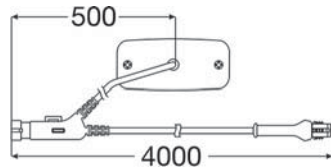
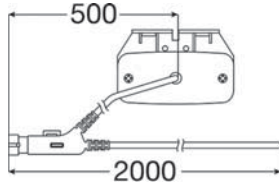
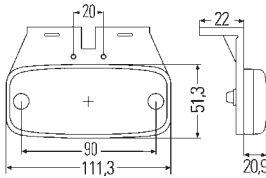
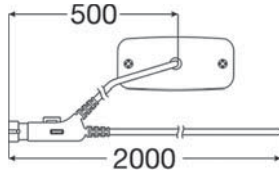
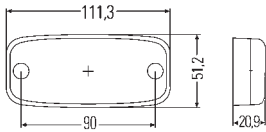

Part no.	Pk.	
		Amber lens with reflector. Black base plate.
2PS 345 600-101	1	Side-marker light with reflector and 2000/500 mm long lead, 24V1.3W
2PS 345 600-111	1	Side-marker light with reflector, 2000/500 mm long lead and bracket, angled back, 24V1.3W
2PS 345 600-041 2PS 345 600-047	1 20	Side-marker light with reflector, 4000/500 mm long lead and system plug, 24V1.3W
2PS 345 600-021 2PS 345 600-027	1 20	Side-marker light with reflector, 4000/500 mm long lead, system plug and bracket, angled back, 24V1.3W
2PS 345 600-091	1	Side-marker light with reflector, 5500/500 mm long lead, 6.3 mm blade terminal contacts and bracket, angled back, 24V1.3W
2PS 345 600-051 2PS 345 600-057	1 20	Side-marker light with reflector, 4500 mm long lead and system plug, 24V1.3W
2PS 345 600-031 2PS 345 600-037	1 20	Side-marker light with reflector, 4500 mm long lead, system plug and bracket, angled back, 24V1.3W
9GD 341 063-007	20	Accessories: Gasket

For horizontal or vertical surface mounting

With 24V bulb.

Two fixing screws. Contacting via splice clamp connection.

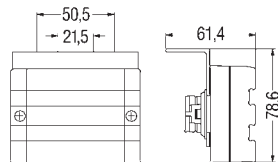
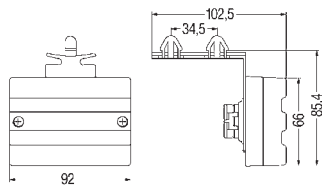
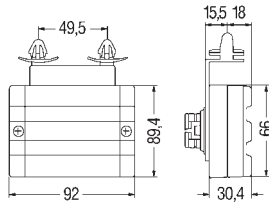
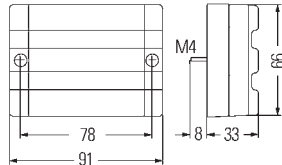

Part no.	Pk.	
		For front mounting. Clear lens.
2PF 340 000-111	1	Position light without reflector
2PG 340 000-121	1	Position light with reflector
8GM 002 092-241	10	Spare parts: C5W bulb, 24V
		Amber lens with reflector.
2PS 340 000-001	1	Side-marker light with reflector
2PS 340 000-171	1	Side-marker light with reflector and 35 mm mounting bracket
8GM 002 092-241	10	Spare parts: C5W bulb, 24V
		Side-marker light with reflector and transverse clip angle, front, for horizontal mounting
2PS 340 000-011	1	
8GM 002 092-241	10	Spare parts: C5W bulb, 24V
		Side-marker light with reflector and longitudinal clip angle, rear, for horizontal mounting
2PS 340 000-021	1	
		Side-marker light with reflector and PC lens, with longitudinal clip angle, rear, for horizontal mounting
2PS 340 000-051	1	
8GM 002 092-241	10	Spare parts: C5W bulb, 24V
		Side-marker light with reflector, holder mounting surface points towards the back
2PS 340 000-041	1	
8GM 002 092-241	10	Spare parts: C5W bulb, 24V

Combinable lights

008 645 / 011 422 series



For horizontal or vertical surface mounting

When attached horizontally, the optical field must point toward the outside of the vehicle.
 Can also be used as clearance light with reflector.
 In LED-technology. With 1 LED.
 Red lens with reflector.

Consumption: 0.04A at 12V/24V.
 Black body. Two holes for B4.2 fixing screws.
 See LED instruction 2.

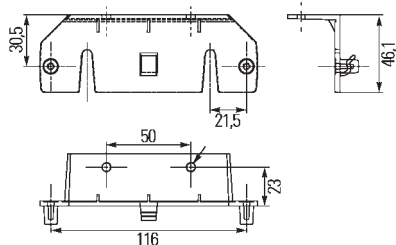
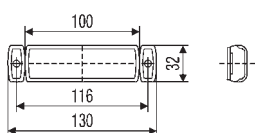
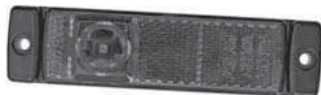

Part no.	Pk.	
2TM 008 645-931	1	Rear light with reflector
2TM 008 645-937	50	with 500 mm long lead, 12V0.6W
2TM 008 645-951	1	with 500 mm long lead, 24V1.2W
2TM 008 645-957	50	
2TM 008 645-921	1	with 5000 mm long lead, 12V0.6W
2TM 008 645-941	1	with 5000 mm long lead, 24V1.2W
2TM 008 645-947	50	
2TM 008 645-651	1	with 300 mm long lead and quick-link incl. clamping piece for contacting a two-core flat lead, 24V1.2W
2TM 008 645-661	1	with 5000 mm long lead and quick-link incl. clamping piece for contacting a two-core flat lead, 24V1.2W
Accessories:		
9GD 157 876-007	55	Gasket
8PE 008 932-001	1	Mounting pliers for quick-link lead attachment
8HG 340 489-001	1	Holder, angled back
8HG 340 413-001	1	Clip angle, rear
8KW 998 602-002	1	Clamping piece for quick-link lead attachment
8HG 160 409-002	10	Holder with two fixing screws

For horizontal or vertical surface mounting

When attached horizontally, the optical field must point toward the outside of the vehicle.
In LED-technology. With 1 LED.

Clear lens with reflector.

Consumption: 0.04A at 12V/24V.

Black body (-917 white). Two holes for B4.2 fixing screws.
See LED instruction 2.

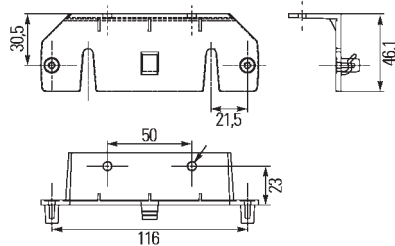
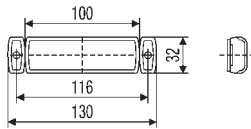

Part no.	Pk.	
2PG 008 645-561	1	Position light with reflector with 500 mm long lead, 12V0.6W
2PG 008 645-567	50	
2PG 008 645-971	1	with 500 mm long lead, 24V1.2W
2PG 008 645-977	50	
2PG 008 645-961	1	with 5000 mm long lead, 24V1.2W
2PG 008 645-967	50	
2PG 011 422-091	1	with 1000 mm lead, 24V1.2W
2PG 011 422-277	50	with 1500 mm lead and 2-pole AMP plug connector, 24V1,2W
2PG 008 645-831	1	with 450 mm long lead and 2-pole AMP-Superseal plug connector, 24V1.2W
2PG 008 645-631	1	with 300 mm long lead and quick-link incl. clamping piece for contacting a two-core flat lead, 24V1.2W
2PG 008 645-541	1	with 1300 mm long lead and quick-link incl. clamping piece for contacting a two-core flat lead, 24V1.2W
2PG 008 645-641	1	with 5000 mm long lead and quick-link incl. clamping piece for contacting a two-core flat lead, 24V1.2W
2PG 008 645-917	50	Position light with reflector, with white body and 5000 mm long lead, 24V1.2W
9GD 157 876-007	55	Accessories: Gasket
8PE 008 932-001	1	Mounting pliers for quick-link lead attachment
8HG 340 489-001	1	Holder, angled back
8HG 340 413-001	1	Clip angle, rear
8KW 998 602-002	1	Clamping piece for quick-link lead attachment
8HG 160 409-002	10	Holder with two fixing screws

For horizontal or vertical surface mounting

When attached horizontally, the optical field must point toward the outside of the vehicle.
In LED-technology. With 1 LED.

Amber lens with reflector.

Consumption: 0.04A at 12V/24V.

Black body. Two holes for B4.2 fixing screws.

See LED instruction 2.

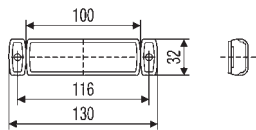

Part no.	Pk.	
2PS 008 645-011	1	Side-marker light with reflector for horizontal flush/surface mounting, with 1500 mm long lead, 12V0.6W
2PS 008 645-017	50	
2PS 008 645-507	50	with 500 mm lead, 12V1.2W
2PS 008 645-787	50	with 1300 mm long lead, 24V1.2W
2PS 008 645-001	1	with 1500 mm long lead, 24V1.2W
2PS 008 645-007	50	
2PS 008 645-187	50	with 5000 mm long lead, 24V1.2W
2PS 008 645-497	50	with 10000 mm long lead, 24V1.2W
2PS 008 645-891	1	with 500 mm long lead and 2-pole AMP-Superseal plug connector, 24V1.2W
2PS 008 645-601	1	with 150 mm long lead and quick-link incl. clamping piece for contacting a two-core flat lead, 24V1.2W
2PS 008 645-607	50	
2PS 008 645-797	50	with 150 mm long lead and quick-link incl. clamping piece for contacting a two-core flat lead and bracket, 24V1.2W
2PS 008 645-611	1	with 300 mm long lead and quick-link incl. clamping piece for contacting a two-core flat lead, 24V1.2W
2PS 008 645-717	50	with 500 mm long lead and quick-link incl. clamping piece for contacting a two-core flat lead, 24V1.2W
2PS 008 645-621	1	with 1300 mm long lead and quick-link incl. clamping piece for contacting a two-core flat lead, 24V1.2W
2PS 008 645-981	1	Side-marker light with reflector for vertical surface mounting, with 1500 mm long lead, 12V0.6W
2PS 008 645-991	1	
2PS 011 422-341	1	with 250 mm long lead and 2-pole AMP-Superseal plug connector, 24V1.2W
2PS 011 422-347	50	
9GD 157 876-007	1	Accessories: Gasket Mounting pliers for quick-link lead attachment Holder, angled back Clip angle, rear Clamping piece for quick-link lead attachment
8PE 008 932-001	1	
8HG 340 489-001	1	
8HG 340 413-001	1	
8KW 998 602-002	1	
8HG 160 409-002	10	

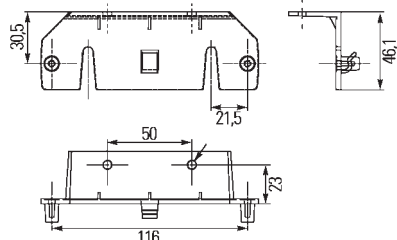

For surface mounting

OneLED

In LED-technology. With 1 LED.

Consumption: 0.04A at 12V and 24V.

With 6.3 mm blade terminals.

See LED instruction 2.

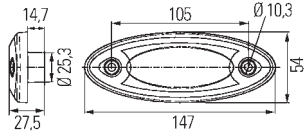

Part no.	Pk.	
		For horizontal surface mounting. Red lens with reflector. Red body.
2TM 344 690-357	96	Rear light with reflector, with 500 mm long lead, 12V0.5W
		For horizontal surface mounting. Clear lens with reflector. White body.
2PG 344 690-307	96	Position light with reflector, with 500 mm long lead, 12V0.5W
		Accessories:
9GD 343 697-007	50	Gasket, black
9GD 343 697-107	50	grey

Combinable lights

344 690 series



For surface mounting

OneLED

In LED-technology. With 1 LED.

Consumption: 0.04A at 12V/24V.

See LED instruction 2.

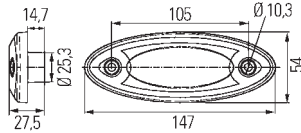

Part no.	Pk.	
		For horizontal or vertical surface mounting. Amber lens with reflector. White body.
2PS 344 690-007	96	Side-marker light with reflector with 6.3 mm blade terminals, 12V0.5W
2PS 344 690-607	84	Side-marker light with reflector, with 2-pole AMP plug connector, 12V0.5W
		For horizontal or vertical surface mounting. Amber lens with reflector. Amber body.
2PS 344 690-687	84	Side-marker light with reflector with 2-pole AMP-Superseal plug connector, 24V1.0W
		For horizontal or vertical surface mounting. Amber lens with reflector. Grey body.
2PS 344 690-027	96	Side-marker light with reflector with 6.3 mm blade terminals, 12V0.5W
		For horizontal or vertical surface mounting Amber lens with reflector. Black body.
2PS 344 690-067	96	
2PS 344 690-037	96	Side-marker light with reflector with 6.3 mm blade terminals, 24V1.0W
2PS 344 690-617	84	Side-marker light with reflector, with 2-pole AMP plug connector, 12V0.5W
2PS 344 690-627	84	Side-marker light with reflector with 2-pole AMP-Superseal plug connector, 24V1.0W
		Accessories:
9GD 343 697-007	50	Gasket, black
9GD 343 697-107	50	grey

Bulb versions for horizontal flush mounting. LED versions for horizontal surface mounting

Two holes for M3.5 fixing screws.
See LED instruction 2.

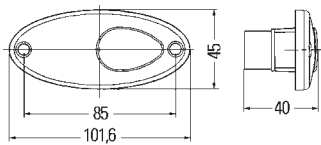
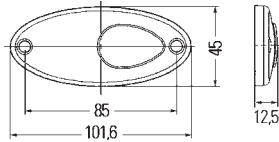

Part no.	Pk.	
		In LED-technology. With 2 LEDs. Red lens with reflector. With gasket and 5000 mm long lead. Consumption: 0.04A at 12V/24V.
2TM 964 295-101	1	Rear light with reflector, 12V0.5W
2TM 964 295-107	20	
2TM 964 295-091	1	Rear light with reflector, 24V1.0W
2TM 964 295-097	20	
		Red lens with reflector. With gasket and 12V bulb.
2XS 964 295-031	1	Clearance light
2XS 964 295-037	50	
		Spare parts/Accessories:
8GP 003 594-121	10	W5W bulb, 12V
9GT 343 367-002	30	Grommet
		For side mounting. Amber lens. With gasket and 12V bulb.
2BM 964 295-041	1	Auxiliary indicator
2BM 964 295-047	50	
		Spare parts/Accessories:
8GP 003 594-121	10	W5W bulb, 12V
9GT 343 367-002	30	Grommet
		Amber lens with reflector. With gasket and 12V bulb.
2PS 964 295-001	1	Side-marker light with reflector
2PS 964 295-007	50	
		Spare parts/Accessories:
8GP 003 594-121	10	W5W bulb, 12V
9GT 343 367-002	30	Grommet
		In LED-technology. With 2 LEDs. Amber lens with reflector. With two 500 mm long leads, gasket and screw fixing. Consumption: 0.04A at 12V/24V.
2PS 964 295-061	1	Side-marker light with reflector, 12V0.5W
2PS 964 295-067	80	
2PS 964 295-051	1	Side-marker light with reflector, 24V1.0W
2PS 964 295-057	80	
2PS 964 295-347	80	Side-marker light with reflector, with 2-pole Superseal plug connector, 24V1.0W
2PS 964 295-357	80	Side-marker light with reflector with 2-pole AMP-Superseal plug connector, 24V1.0W
		In LED-technology. With 2 LEDs. Amber lens with reflector. Self-adhesive, with two 500 mm long leads and covers for fixing holes. Consumption: 0.04A at 12V/24V.
2PS 964 295-081	1	Side-marker light with reflector, 12V0.5W
2PS 964 295-071	1	Side-marker light with reflector, 24V1.0W
2PS 964 295-077	80	

Combinable lights

964 295 series



Bulb versions for horizontal flush mounting. LED versions for horizontal surface mounting

Two holes for M3.5 fixing screws.
See LED instruction 2.

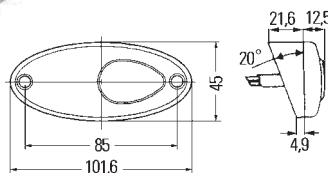
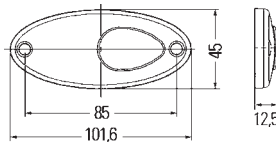
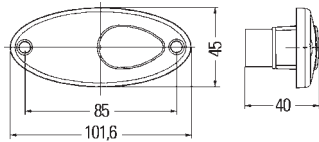

Part no.	Pk.	
		For front mounting. Clear lens. With gasket and 12V bulb.
2PG 964 295-011	1	Position light with reflector
2PG 964 295-017	50	
8GP 003 594-121	10	Spare parts/Accessories: W5W bulb, 12V
9GT 343 367-002	30	Grommet
		For front mounting. In LED-technology. With 2 LEDs and gasket. Clear lens with reflector. Consumption: 0.03A at 12V/24V.
2PG 964 295-121	1	Position light with reflector, with 5000 mm long lead, 12V0.3W
2PG 964 295-127	30	
2PG 964 295-367	80	Position light with reflector with 800 mm long lead and stripped ends, 12V0.3W
2PG 964 295-111	1	Position light with reflector, with 5000 mm long lead, 24V0.6W
2PG 964 295-117	20	
		For front mounting. Clear lens with reflector. With gasket and 12V bulb.
2PF 964 295-021	1	Position light
2PF 964 295-027	50	
8GP 003 594-121	10	Spare parts/Accessories: W5W bulb, 12V
9GT 343 367-002	30	Grommet
		For front mounting. In LED-technology. Clear lens without reflector. With 2 LEDs and loose angular bracket (RAL 9010) for mounting to surfaces with an inclination of 20°. With 100 mm PVC lead and 2.8 mm blade terminal contacts with insulating sleeve. Consumption: 0.03A at 12V.
2PF 964 295-257	20	Position light, 12V0.3W

Reflector for horizontal or vertical surface mounting

For lights in model range 964 295-...
Self-adhesive.

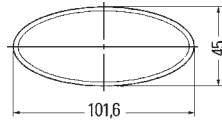

Part no.	Pk.	
8RA 343 160-002	20	Reflector, red
8RA 343 160-007	150	
8RA 343 160-017	150	white
8RA 343 160-022	20	amber
8RA 343 160-027	150	

2

For horizontal or vertical flush mounting

In LED-technology. Clear lens.

Consumption: 0.04A at 12V, 0.02A at 24V.
With gasket covers for fixing holes.
See LED instruction 2.

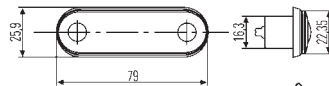

Part no.	Pk.	
		Red light. With 2 red LEDs 0.5W. Voltage range: 8V - 28V. For optional use as rear light or clearance light.
2XA 959 790-401	2	Signal light with 500 mm long lead
2XA 959 790-407	30	
2XA 959 790-411	2	Signal light with 5000 mm long lead
		White light. With 1 white LED 0.5W. Voltage range: 8V - 28V.
2PF 959 590-202	2	Position light with 500 mm long lead
2PF 959 590-207	30	
2PF 959 590-212	2	Position light with 5000 mm long lead
2PF 959 590-217	10	
2PF 959 590-218	105	
2PF 959 590-237	8	Position light with 8000 mm long lead
2PF 959 590-247	12	
2PF 959 590-257	30	Position light with 100 mm long lead, 2-pole AMP plug connector and two 6.3 mm blade terminal contacts
9XD 160 867-007	16	Accessories: Bracket (adapter) for mounting the lights

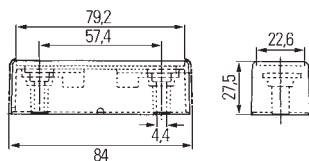

Combinable lights

959 510 - 980 855 series



For horizontal flush mounting

In LED-technology. Amber lens.

Consumption: 0.04A at 12V, 0.02A at 24V.

With gasket covers for fixing holes.

See LED instruction 2.

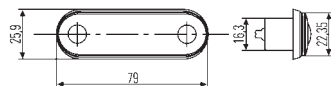

Part no.	Pk.	
		Amber light. With 1 amber LED 0.5W. Voltage range: 8V - 28V.
2PS 959 788-002	2	Side-marker light with 500 mm long lead

For flush or surface mounting

In LED-technology. Clear lens.

Consumption: 0.04A at 12V, 0.02A at 24V.

See LED instruction 2.

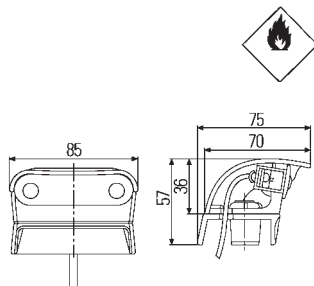
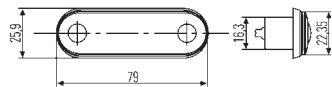

Part no.	Pk.	
		White light. With 2 white LEDs 0.5W. Black plastic body. With 2500 mm long lead, cover, fixing screws and caps for screws. Voltage range: 10V - 33V.
2KA 959 640-102	3	Licence plate light for flush mounting above 520 x 120 mm licence plates (3 lights)
2KA 959 640-607	8	Licence plate light with spacer for surface mounting to the left and right of 520 x 120 mm licence plates

For flush mounting

In LED-technology. Clear lens.

Consumption: 0.04A at 12V, 0.02A at 24V.

With gasket and two fixing screws.

Dust and water-proof, with polarity reversal protection.

Voltage range: 10V - 33V.

Type of protection: IP6K6, IP6K9K.

See LED instruction 2.

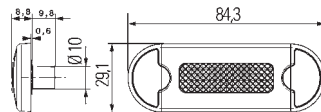

Part no.	Pk.	Description
2PF 959 855-201	1	Position light with black screw caps, 2 white LEDs 0.5W and 500 mm long lead
2PF 959 855-207	24	
2PF 959 855-241	1	2 white LEDs 0.5W and 2500 mm long lead
2PF 959 855-247	16	
2PF 959 855-251	1	Position light with white screw caps, 2 white LEDs 0.5W and 500 mm long lead
2PF 959 855-257	24	
2XS 959 855-401	1	Clearance light with black screw caps, 2 red LEDs 0.5W and 500 mm long lead
2XS 959 855-407	24	
2XS 959 855-441	1	2 red LEDs 0.5W and 500 mm long lead
2XS 959 855-447	16	
2XS 959 855-451	1	Clearance light with white screw caps, 2 red LEDs 0.5W and 500 mm long lead
2XS 959 855-457	24	
2XT 959 510-427	36	Door light with black screw caps, 2 white LEDs 0.5W and 120 mm long lead
2XT 980 855-111	1	
2XT 980 855-117	16	2 white LEDs 0.5W and 500 mm long lead
2XT 959 510-397	24	
2XT 959 510-467	24	2 white LEDs 0.5W, 120 mm long lead and 2-pole DEUTSCH plug connector
2XT 959 510-657	36	2 white LEDs 0.5W, 150 mm long lead and 2-pole Packard plug
2XT 980 855-411	1	2 blue LEDs 0.5W and 120 mm long lead
2XT 980 855-417	16	
9AB 959 685-201	1	Spare parts/Accessories:
9HD 980 858-018	4	

Combinable lights

009 226 series



For surface mounting

In LED-technology.

Consumption: 0.06A at 12V/24V. Self-adhesive. See LED instruction 2.

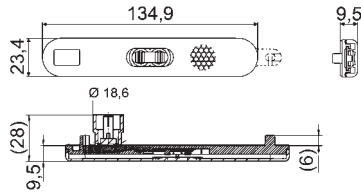

Part no.	Pk.	
2XS 009 226-107	300	<p>For horizontal surface mounting. With 2 red LEDs. Red lens. Red body.</p> <p>Clearance light with 6.3 mm blade terminals, 12V1,0W</p>
2PF 009 226-097	300	<p>For horizontal surface mounting. With 2 white LEDs. Clear lens. Clear body.</p> <p>Position light with 6.3 mm blade terminals, 12V1.0W</p>
2PS 009 226-021	1	<p>For horizontal surface mounting. With 2 amber LEDs. Amber lens with reflector. Clear, amber body.</p> <p>Side-marker light with reflector with 195 mm long lead, 12V1.0W</p>
2PS 009 226-027	300	<p>Side-marker light with reflector with 195 mm long lead and 2-pole AMP plug connector, 24V1.0W</p>
2PS 009 226-007	300	<p>For horizontal surface mounting. With 2 amber LEDs. Amber lens with reflector. Black body.</p> <p>Side-marker light with reflector without lead, with 6.3 mm blade terminals, 12V1.0W</p>
2PS 009 226-067	300	<p>Side-marker light with reflector with 100 mm long lead and AMP-Superseal plug connector, 12V1.0W</p>
2PS 009 226-017	300	<p>Side-marker light with reflector with 195 mm long lead and 2-pole AMP plug connector, 24V1.0W</p>
2PS 009 226-031	1	<p>Side-marker light with reflector with 250 mm long lead, without AMP plug connector, 24V1.0W</p>
2PS 009 226-037	300	<p>Side-marker light with reflector with PMMA lens and 250 mm lead with 2-pole AMP plug connector, 24V1.0W</p>
2PS 009 226-157	150	<p>Side-marker light with reflector and 250 mm long lead with 2-pole AMP plug connector, 24V1,0W</p>
2PS 009 226-167	150	<p>Accessories: Grommet</p>
9GT 186 597-007	600	<p>For vertical surface mounting. With two amber LEDs. Amber light. Amber lens with reflector. Black body.</p>
2PS 009 226-077	300	<p>Side-marker light with reflector with 195 mm long lead, 12V1.0W</p>
2PS 009 226-087	300	<p>Side-marker light with reflector with 195 mm long lead, 24V1.0W</p>
8RA 009 226-117	300	<p>Reflector, clear</p>
8RA 009 226-127	300	<p>amber</p>
8RA 009 226-137	300	<p>red</p>

For surface mounting

Clear lens.

For surface mounting above 340 x 240 mm (1 light) and 520 x 120 mm (1 or 2 lights) licence plates or mounting to left and right of 340 x 240 mm and 520 x 120 mm licence plates. Two 4.5 mm dia. holes for fixing screws.

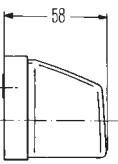
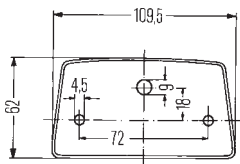
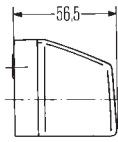
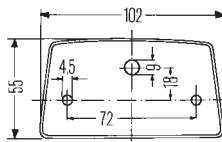
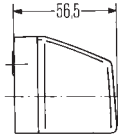
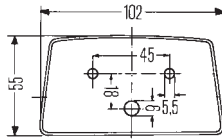

Part no.	Pk.	
Grey plastic body and black plastic base plate.		
2KA 003 389-011	1	Licence plate light
<hr/>		
2KA 003 389-001	1	Licence plate light
Accessories:		
		R10W bulb,
8GA 002 071-131	10	12V
8GA 002 071-251	10	24V
8GA 002 071-271	10	24V (HD)
<hr/>		
Body and base plate of black plastic.		
2KA 003 389-061	2	Licence plate light
2KA 003 389-068	56	Licence plate light
2KA 003 389-062	1	Pro-fit pack
2KA 003 389-398	56	Licence plate light with 12V bulb
2KA 003 389-081	1	Licence plate light with 26 mm dia. opening in base plate for lead retention
Spare parts/Accessories:		
9BG 121 587-031	2	Body with lens and screws
9BG 121 587-037	60	
		R10W bulb,
8GA 002 071-131	10	12V
8GA 002 071-251	10	24V
8GA 002 071-271	10	
<hr/>		
With black rubber base plate and vibration damping.		
2KA 003 389-211	2	Licence plate light
2KA 003 389-217	48	
9BG 121 587-071	2	Body with lens and screws
		R10W bulb,
8GA 002 071-131	10	12V
8GA 002 071-251	10	24V

Combinable lights

003 389 series



For surface mounting

Body and base plate of black plastic.
Two 4.5 mm dia. holes for fixing screws.

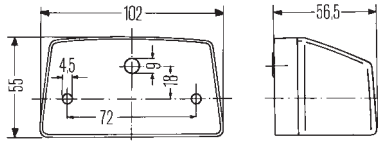

Part no.	Pk.	
2PF 003 389-037	1	Clearance light with clear lens
		Accessories:
		R10W bulb,
8GA 002 071-131	10	12V
8GA 002 071-251	10	24V
2PF 003 389-041	1	Clearance light with red lens
		Accessories:
		R5W bulb,
8GA 002 071-121	10	12V
8GA 002 071-241	10	24V

For horizontal flush mounting

In LED-technology. With 4 LEDs and 500 mm long lead.
Amber lens with reflector.
 Consumption: 0.04A at 24V.
 See LED instruction 2.

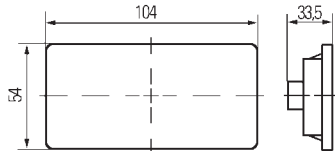

Part no.	Pk.	
2PS 007 972-011	4	Side-marker light with reflector, 24V1.0W
2PS 007 972-017	100	

For horizontal surface mounting

In LED-technology. With 3 LEDs.
Amber lens with reflector.
 Consumption: 0.06A at 12V/24V.
 Grey base plate. With 500 mm long lead with stripped ends.
 Two 4.5 mm dia. holes for fixing screws.
 See LED instruction 2.

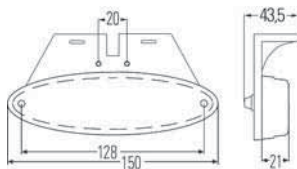
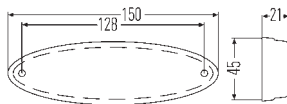

Part no.	Pk.	
Without bracket.		
2PS 007 943-311	8	Side-marker light with reflector, 12V0.7W
2PS 007 943-317	105	
2PS 007 943-011	8	Side-marker light with reflector, 24V1.4W
2PS 007 943-017	105	
With bracket, angled forwards.		
2PS 007 943-321	10	Side-marker light with reflector, 12V0.7W
2PS 007 943-021	10	
2PS 007 943-027	124	Side-marker light with reflector, 24V1.4W

For flush mounting in front or rear plastic bumpers

For retrofitting passengers cars < 6 m.
 In LED-technology. Amber light.
Contents: 4 side-marker lights, each with 3 LEDs and installation material.
 Consumption: 0.06A at 12V.
 See LED instruction 2.

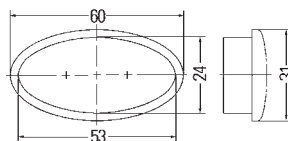

Part no.	Pk.	
2PS 008 138-801	1	Side-marker light set, 12V0.7W, with amber lens and silver grey shields
2PS 008 138-811	1	with light grey lens and black shields
2PS 008 138-821	1	with light grey lens and silver grey shields
Spare parts:		
2PS 008 138-001	1	Side-marker light for -801
2PS 008 138-101	1	for -811
2PS 008 138-111	1	for -821

For horizontal flush/surface mounting

In LED-technology. With 2 LEDs.
 Amber lens with reflector.
 Black plastic body.
 Consumption: 0.06A at 12V/24V.
 See LED instruction 2.

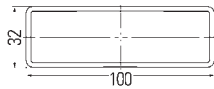

Part no.	Pk.	
2PS 008 643-007	300	Side-marker light with reflector for flush mounting, 24V1.4W
2PS 008 643-011 2PS 008 643-017	1 30	with bracket, angled backwards, 24V1.4W
2PS 008 643-021 2PS 008 643-027	1 30	with bracket, angled forwards, 24V1.4W
2PS 008 643-331	1	with universal bracket, angled backwards, 12V0.7W
2PS 008 643-031 2PS 008 643-037	1 30	with universal bracket, angled forwards, 24V1.4W

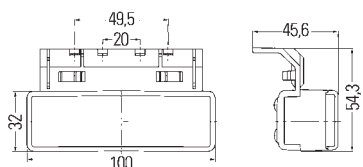
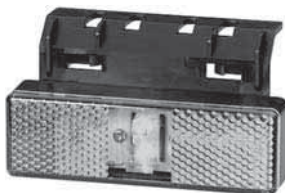
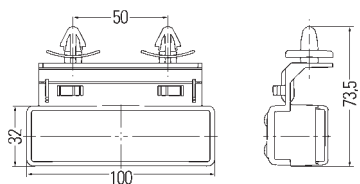
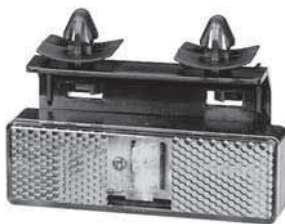
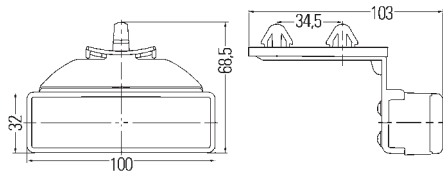

For horizontal surface mounting

In LED-technology. With 2 LEDs.

Amber lens with reflector.

Consumption: 0.04A at 24V.

See LED instruction 2.

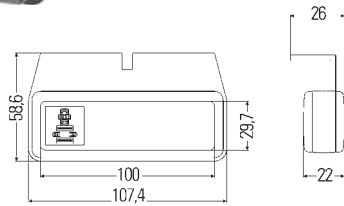
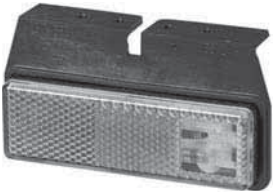
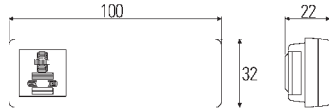

Part no.	Pk.	
2PS 008 616-001	1	Side-marker light with reflector without angular bracket, 24V1.0W
2PS 008 616-011 2PS 008 616-017	1 30	with bracket, angled backwards, 24V1.0W

For horizontal flush or surface mounting

In LED-technology. With 4 LEDs. Amber lense.

Consumption: 0.04A at 24V.

See LED instruction 2.

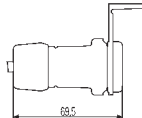
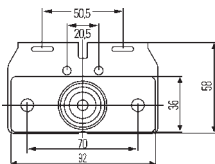
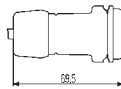
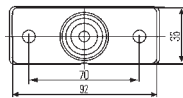
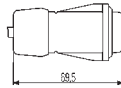
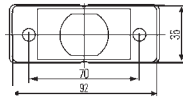

Part no.	Pk.	
2PS 008 382-007	60	Side-marker light in combination with reflector 9EL 154 637-001.
		Side-marker light for flush mounting, 24V1.0W
<hr/>		
Contents: Side-marker light without reflector, with separate reflector.		
2PS 008 382-801	1	Side-marker light set for flush mounting, 24V1.0W
<hr/>		
Contents: Side-marker light without reflector, with separate reflector.		
2PS 008 382-811	1	Side-marker light set with bracket, angled forwards, for surface mounting, 24V1.0W
2PS 008 382-817	72	
<hr/>		
Spare parts:		
2PS 008 382-001	1	Side-marker light with reflector
9EL 154 637-001	1	Reflectors

For horizontal flush mounting

Black rubber body.
Two holes for B4.2 x 19 fixing screws.

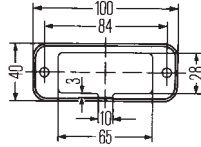
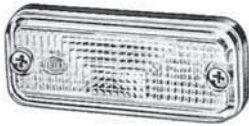

Part no.	Pk.	
		Red lens.
2SA 961 167-011	2	Rear light for installation positions 0° - 4°
		Clear lens.
2PF 961 167-021	2	Position light for installation positions 60° - 67°
9EL 137 241-001	4	Spare parts/Accessories: Clear lens with contact springs
8GM 002 092-121	10	C5W bulb, 12V
8GM 002 092-241	10	24V

In LED-technology. With 2 Power LEDs 0.5W. Clear lens.

Consumption: 0.02A at 24V. Black rubber body.
2 holes in the lens for attachment of the light using 2 PT screws 5 x 25 Torx and 2 washers Ø 4.2 mm (not part of the scope of supply).
Tightening torque max. 2 Nm. See LED instruction 2.

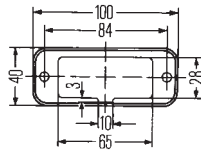

Part no.	Pk.	
2PF 009 514-001	1	Position light for installation positions 10° - 20°
2PF 009 514-011	1	for installation positions 20° - 30°

For flush mounting

Two holes for B4.2 x 16 fixing screws.

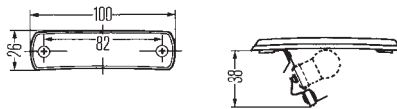

Part no.	Pk.	
		Red lens.
		National type test for Germany.
2SA 001 647-041	1	Rear light
		Clear lens.
2PF 001 647-031	4	Position light
2PF 001 647-037	80	
		Accessories:
8GA 002 071-121	10	R10W bulb, 12V
8GA 002 071-241	10	24V

For surface mounting

For roof mounting.

Grey plastic body. With rubber base.
Roof inclination (0° - 90°) can be compensated.
Two 5.3 mm dia. holes for fixing screw.

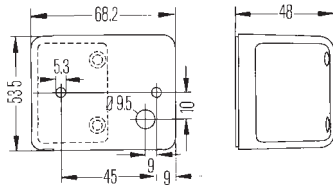

Part no.	Pk.	
		Red lens.
2SA 006 679-027	1	Rear light
		Clear lens.
2PF 006 679-007	20	Position light
		Accessories:
		R10W bulb,
8GA 002 071-131	10	12V
8GA 002 071-251	10	24V

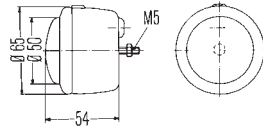

Black body. Central M5 fixing screw.

Part no.	Pk.	
		Red lens.
2SA 001 634-121	2	Rear light
		Clear lens.
2PF 001 634-101	2	Position light
		Spare parts/Accessories:
		Lens with screw
		for -121
		for -101
		C5W bulb,
9EL 132 404-001	2	12V
9EL 132 403-001	2	24V
8GM 002 092-121	10	12V
8GM 002 092-241	10	24V

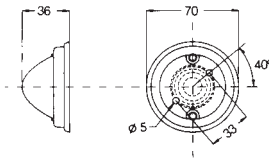

Steel base plate with soft plastic backing.
Two holes for M4 fixing screws. Screw-contact.

Part no.	Pk.	
		Red lens.
2SA 997 022-001	1	Rear light with chrome-plated rim
2SA 997 023-001	1	Rear light without chrome-plated rim
		Clear lens.
2PF 997 022-011	1	Position light with chrome-plated rim
2PF 997 023-011	1	Position light without chrome-plated rim
		Accessories:
		C5W bulb,
8GM 002 092-121	10	12V
8GM 002 092-241	10	24V

For surface mounting

In LED-technology.

Black plastic body.

Consumption: 0.05A at 12V, 0.03A at 24V.

Type of protection: IP6K6, IP6K7. See LED instruction 2.



2XA 959 560-401
2XA 959 560-407

2
16

**Red light, clear lens,
inner lens red.**
Voltage range: 8V - 28V.

**Clearance light
with 2 LEDs 0.5W and 500 mm long lead**



2XA 959 560-411
2XA 959 560-417

2
10

**Clearance light
with 2 LEDs 0.5W and 5000 mm long lead**

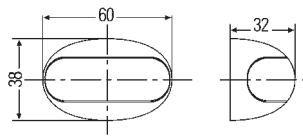

2PF 959 570-202
2PF 959 570-207

2
16

White light, clear lens.
Voltage range: 10V - 33V.

**Position light
with 1 LED 0.8W and 500 mm long lead**



2PF 959 570-212
2PF 959 570-217

2
10

**Position light
with 1 LED 0.8W and 5000 mm long lead**



2XT 959 630-351

1

**Red light, clear lens,
inner lens red.**
Voltage range: 8V - 28V.

**Door light
with 2 LEDs 0.8W and 550 mm long lead**

For surface mounting

Chrome-plated body.
Two B4.8 x 19 fixing screws.

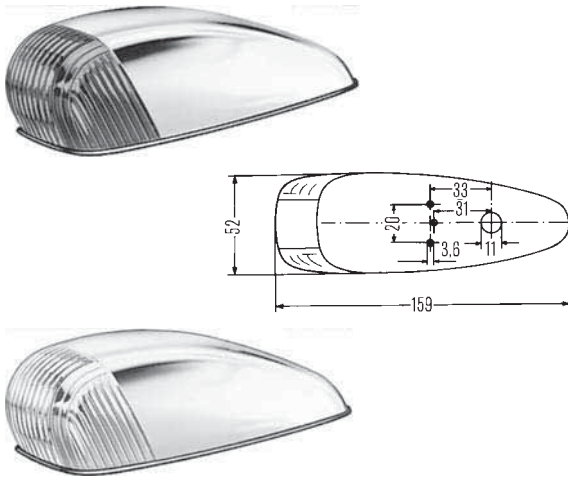

Part no.	Pk.	
		Red lens.
2SA 001 638-021	2	Rear light
		Spare parts/Accessories:
		Rubber base
9GD 100 140-001	10	for curved surfaces
8GP 003 594-121	10	W5W bulb,
8GP 003 594-241	10	12V
		24V
		Clear lens.
2PF 001 638-011	2	Position light
		Spare parts/Accessories:
		Rubber base
		for curved surfaces
9GD 100 140-001	10	R5W bulb,
8GA 002 071-121	10	12V
8GA 002 071-241	10	24V

For horizontal or vertical surface mounting

Red rear light, white position light.
With M10 x 1 fixing screw.

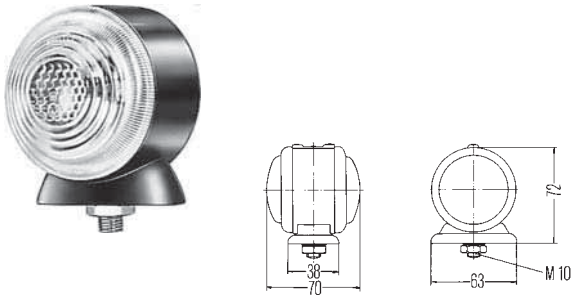

Part no.	Pk.	
2TJ 001 633-211	2	Rear-position light
		Spare parts/Accessories:
		Lens with screw,
		white
9EL 132 403-001	2	red
9EL 132 404-001	2	C5W bulb,
8GM 002 092-121	10	12V
8GM 002 092-241	10	24V

For flush mounting

Clear lens, with reflector.
With 24V bulb.

Contacting via 2.8 mm blade terminals.
 Two 5 mm dia. holes for fixing screws.

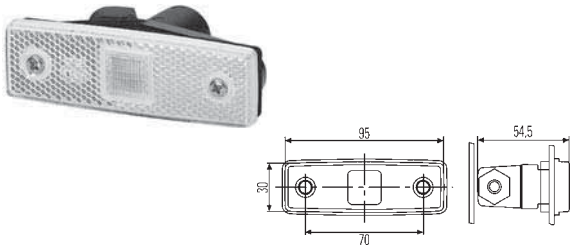

Part no.	Pk.	
2PG 008 434-001	2	Position light with reflector
8GP 002 067-241	10	Spare parts: T4W bulb, 24V

Clear lens.

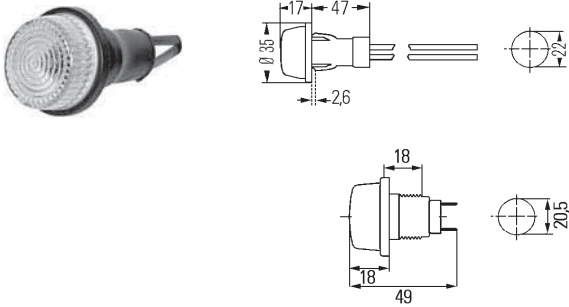

Part no.	Pk.	
2PF 003 563-151	10	With 800 mm long earth lead and 1800 mm long earth lead. Position light
2PF 003 563-177	100	Without lead. With plastic nut M20 x 1.5 and 6.3 mm blade terminal contact. The light is fastened by rear screwing of the plastic nut. Position light with 12V bulb
2PF 003 563-187	100	Position light with 24V bulb
8GP 003 594-121	10	Spare parts/Accessories: W5W bulb, 12V
8GP 003 594-241	10	24V

For flush mounting in trailer

With rubber body and preinstalled wiring harness.

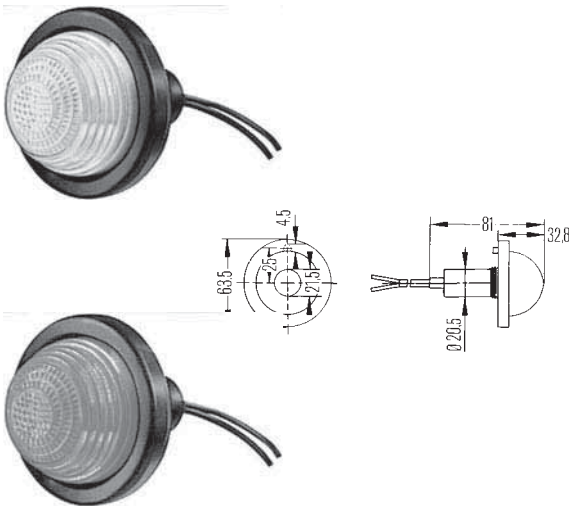

Part no.	Pk.	
2PF 007 205-007	10	Frosted white lens. Position light
2PF 007 205-017	1	With green lens. Trucks and trailers equipped with ABS which do not yet have plug connectors to ISO 3731 (24S), ISO 7638 or ISO 1185 (24N) are required to equip the trailer with a green position light mounted in the field of vision side for indicating the function of the ABS. Position light
8KA 950 073-001	10	Spare parts/Accessories: Lead with bulb holder for -007/-001 R5W bulb,
8GA 002 071-121	10	12V
8GA 002 071-241	10	24V

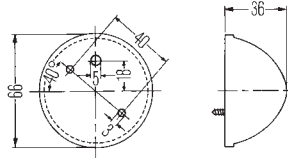

For surface mounting

Clear lens.

Two holes for B3.9 x 9.5 fixing screws.

Part no.	Pk.	
2PF 001 650-001	2	Position light
Spare parts/Accessories:		
8GM 002 092-121	10	C5W bulb, 12V
8GM 002 092-241	10	24V

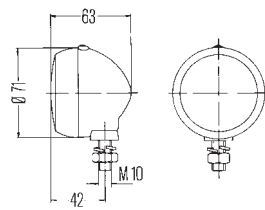

For flush mounting

Clear lens.

Black plastic body.
M10 hollow fixing bolt and lead entry.

Part no.	Pk.	
2PF 001 648-161	4	Position light without chrome-plated rim
2PF 001 648-171	4	with chrome-plated rim
Spare parts/Accessories:		
9EL 108 435-001	5	Lens with screws for -161
8GA 002 071-121	10	R5W bulb, 12V
8GA 002 071-241	10	24V

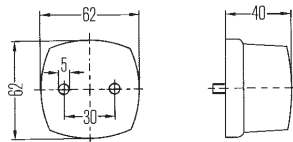

For horizontal or vertical surface mounting

Clear lens. With 12V bulb.

Two M5 fixing screws.

Part no.	Pk.	
2PF 996 112-031	1	Position light
Spare parts/Accessories:		
8GM 002 092-121	10	C5W bulb, 12V

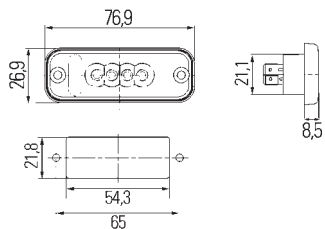

For flush mounting

In LED-technology. With 4 LEDs 1.0W.

Clear lens.

Two 4.5 mm dia. holes for fixing screws.
Consumption: 0.08A at 12V, 0.04A at 24V.

Part no.	Pk.	
2PF 010 278-907	196	Position light, 12V
2PF 010 278-917	196	24V

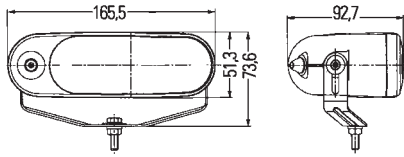

For surface mounting

Clear lens.

Black plastic body.
With one M6 x 20 fixing screw.
Contents: 2 lights incl. wiring harness, bulbs and universal bracket for mounting on front bumper.

Part no.	Pk.	
2PT 008 362-801	1	Daytime running light set, 12V
		Spare parts:
8GH 007 643-121	10	H6W bulb, 12V

For flush or surface mounting

Clear lens.

Body made of diecast aluminium.

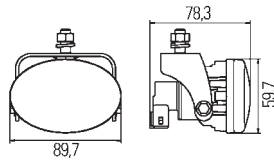

Part no.	Pk.	
2PT 010 047-821	1	Contents: 2 lights incl. lead set, 12V bulbs and universal hoop bracket for mounting to the vehicle front. Daytime running light set, 12V

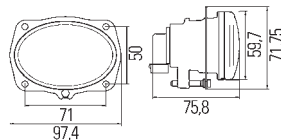

		Mounting by means of carrier frame in the front apron.
2PT 010 047-201	1	Daytime running light with 12V bulb
		Spare parts:
8GA 002 073-121	10	P21W bulb, 12V

Clear lens, without optical pattern.

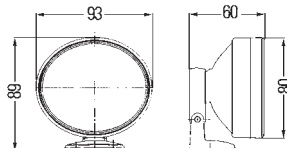

Part no.	Pk.	
2PT 008 935-801	1	Contents: 2 lights with 12V/16W bulbs, 2 brackets with connecting leads, accessories and installation material. Daytime running light set, 12V
		Spare parts:
2PT 008 935-001	1	Light unit contains: reflector with bulb, connecting lead with plug
4RA 933 791-061	1	Relay, 12V

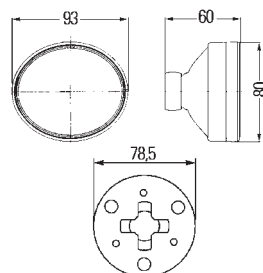

2PT 008 935-011	1	For flush mounting. With bracket, lead with plug and 12V/16W bulb. Daytime running light, 12V
-----------------	---	--

For flush mounting

LEDayFlex

In LED-technology. Clear lens.

Power consumption: daytime running light 12V/24V5.8W, position light 12V/24V0.6W.

Consumption: daytime running light: 0.48A at 12V, 0.24A at 24V.

Consumption: position light: 0.05A at 12V, 0.025A at 24V.

Body made of diecast aluminium.

With 3-pole Superseal plug connector.



Part no.	Pk.	Contents:
		2 lighting systems with 5 individual lights inc. LEDs and 2 electronic control units.
2PT 010 458-701	1	Daytime running light set without position light
2PT 010 458-711	1	Daytime running light set with position light
		Spare parts/Accessories:
		Daytime running light set without position light
2PT 177 696-701	1	with position light
2PT 177 696-711	1	Electronic control module
5DS 010 668-701	1	for -701
5DS 010 668-711	1	for -711
		500 mm long lead with
8KB 178 139-001	1	2-pole Superseal plug connector
8KB 178 139-002	25	
		2700/1800 mm long lead with
8KA 165 959-001	1	3-pole Superseal plug connector
		Contents:
		2 lighting systems with 6 individual lights incl. LEDs and 2 electronic control units.
2PT 010 458-721	1	Daytime running light set without position light
2PT 010 458-731	1	Daytime running light set with position light
		Spare parts/Accessories:
		Daytime running light set without position light
2PT 177 696-721	1	with position light
2PT 177 696-731	1	Electronic control module
5DS 010 668-701	1	for -721
5DS 010 668-711	1	for -731
		500 mm long lead with
8KB 178 139-001	1	2-pole Superseal plug connector
8KB 178 139-002	25	
		2700/1800 mm long lead with
8KA 165 959-001	1	3-pole Superseal plug connector

For flush mounting

LEDayFlex

In LED-technology. Clear lens.

Power consumption: daytime running light 12V/24V5.8W, position light 12V/24V0.6W.

Consumption: daytime running light: 0.48A at 12V, 0.24A at 24V.

Consumption: position light: 0.05A at 12V, 0.025A at 24V.

Body made of diecast aluminium.

With 3-pole Superseal plug connector.



Part no.	Pk.	Contents:
2PT 010 458-741	1	2 lighting systems with 7 individual lights incl. LEDs and 2 electronic control units.
2PT 010 458-751	1	Daytime running light set without position light
		Daytime running light set with position light
		Spare parts/Accessories:
		Daytime running light set without position light
2PT 177 696-741	1	with position light
2PT 177 696-751	1	Electronic control module
5DS 010 668-701	1	for -741
5DS 010 668-711	1	for -751
		500 mm long lead with
8KB 178 139-001	1	2-pole Superseal plug connector
8KB 178 139-002	25	
		2700/1800 mm long lead with
8KA 165 959-001	1	3-pole Superseal plug connector
		Contents:
		2 lighting systems with 8 individual lights incl. LEDs and 2 electronic control units.
2PT 010 458-761	1	Daytime running light set without position light
2PT 010 458-771	1	Daytime running light set with position light
		Spare parts/Accessories:
		Daytime running light set without position light
2PT 177 696-761	1	with position light
2PT 177 696-771	1	Electronic control module
5DS 010 668-701	1	for -761
5DS 010 668-711	1	for -771
		500 mm long lead with
8KB 178 139-001	1	2-pole Superseal plug connector
8KB 178 139-002	25	
		2700/1800 mm long lead with
8KA 165 959-001	1	3-pole Superseal plug connector

For surface or flush mounting

LEDayFlex II

In LED-technology. Clear lens.

Power consumption: 12V/24V4.0W.

Consumption: 0.34A at 12V, 0.17A at 24V.

Plastic body.

Type of protection: IP6K9K and IP6K7.

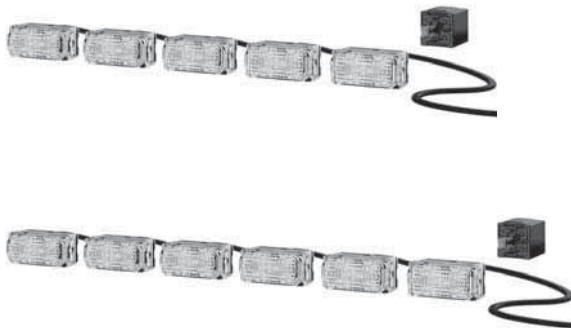

Part no.	Pk.	Contents:
2PT 980 789-851	1	2 lighting systems with 5 individual lights incl. LEDs relay, bracket and 2800 mm long lead.
2PT 980 789-901	1	Daytime running light set, 12V
2PT 980 789-901	1	Daytime running light set, 24V
<hr/>		
Contents:		
2 lighting systems with 6 individual lights inc. LEDs relay, bracket and 2800 mm long lead.		
2PT 980 789-861	1	Daytime running light set, 12V
2PT 980 789-911	1	Daytime running light set, 24V
Spare parts/Accessories:		
Daytime running light with 5 individual lights,		
2PT 980 789-051	1	12V, for -851
2PT 980 789-061	1	24V, for -901
Daytime running light with 6 individual lights,		
2PT 980 789-251	1	12V, for -861
2PT 980 789-261	1	24V, for -911
Bracket set for flush mounting of lighting systems,		
8HG 980 795-801	1	for -851/-901
8HG 980 795-811	1	for -861/-911
Bracket set for flush mounting of lighting systems,		
for mounting on the back,		
8HG 980 793-801	1	for -851/-901
8HG 980 793-811	1	for -861/-911
Bracket set for flush mounting of lighting systems,		
for mounting on the top,		
8HG 980 797-801	1	for -851/-901
8HG 980 797-811	1	for -861/-911

For flush mounting

In LED-technology. With 3 LEDs. Clear lens.
Power consumption: 12V < 5W, 24V < 11W.
 Consumption: 0.36A at 12V/24V.
 With 500 mm connection lead with 3-pin waterproof plug.
 Voltage range: 9V - 33V. See LED instruction 2.

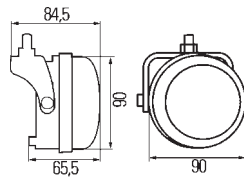
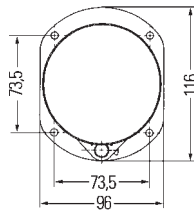
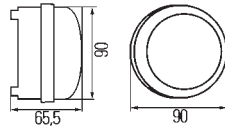

Part no.	Pk.	
		Black aluminium body. Attachment by means of carrier frame in front aprons (see accessories for carrier frames).
2PT 009 599-111	1	Daytime running light for flush mounting, left
2PT 009 599-121	1	Daytime running light for flush mounting, right
2PT 009 599-131	1	Daytime running light with position light for flush mounting, left
2PT 009 599-141	1	Daytime running light with position light for flush mounting, right
		Accessories:
9AH 165 968-001	1	Supporting frame
8HG 165 967-001	1	Bracket
8KA 165 959-001	1	2700/1800 mm long lead with 3-pole Superseal plug connector
8JA 746 184-032	10	Superseal plug, 3-pole
8KW 744 837-002	50	Jack contact for leads 1.0 - 1.5 sq. mm dia. Strand insulation for lead outside
9GD 746 185-002	50	1.8 - 2.4 sq. mm dia.
		Mounting by means of bracket on or in the front apron.
		Contents: 2 lights with 3 LEDs, pre-assembled lead set and mounting instructions
2PT 009 599-811	1	Daytime running light set without position light, aluminium body black coloured, for flush or surface mounting
		Accessories: 2700/1800 mm long lead with 3-pole Superseal plug connector
8KA 165 959-001	1	3-pole Superseal plug connector
8JA 746 184-032	10	Superseal plug, 3-pole
8KW 744 837-002	50	Jack contact for leads 1.0 - 1.5 sq. mm dia. Strand insulation for lead outside
9GD 746 185-002	50	1.8 - 2.4 sq. mm dia.

In LED-technology. With 12 white LEDs 4.0W. Clear lens. With 2500 mm long lead.

Consumption: 0.34A at 12V, 0.17A at 24V.
 Black plastic body.
 With one fixing screw 6.3 mm.
 Type of protection: IP6K7, IP6K9K.
 See LED instruction 2.

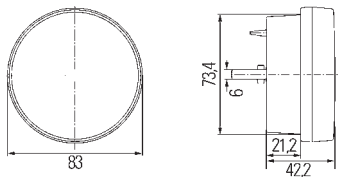

Part no.	Pk.	
2PT 980 691-601	1	Daytime running light, 12V
2PT 980 690-601	1	24V

For flush mounting

LEDayLine

In LED-technology. With 5 white LEDs 8.0W. Clear lens.

Consumption: 0.67A at 12V, 0.33A at 24V.

Black plastic body.

Mounting by means of carrier frame in the front apron

With Superseal connector.

See LED instruction 2.

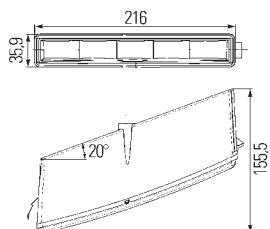

Part no.	Pk.	Contents:
		2 lights 2PT 010 043-011/-021 with wiring harness
2PT 010 043-801	1	Daytime running light set, 12V
		Daytime running light, 12V, left
2PT 010 043-011	1	
2PT 010 043-021	1	right
		Daytime running light, 24V, left
2PT 010 043-031	1	
2PT 010 043-041	1	right
		Accessories:
		Lead set, 2700/1800 mm long, with Superseal plug, 3-pole, for connection 2 daytime running lights
8KA 165 959-001	1	Superseal plug, 3-pole
8JA 746 184-032	10	Jack contact for leads 1.0 - 1.5 sq. mm dia.
8KW 744 837-002	50	Strand insulation for lead outside 1.8 - 2.4 sq. mm dia.
9GD 746 185-002	50	

In LED-technology. With 12 white LEDs 2.0W. Clear lens.

Consumption: 0.17A at 12V, 0.08A at 24V.

Two 4.3 mm dia. holes for fixing screws.

See LED instruction 2.

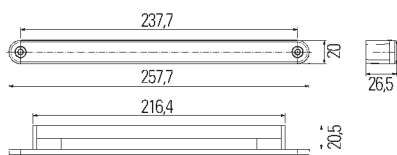

Part no.	Pk.	Contents:
		2 lighting systems with 2500 mm long lead, relay, fixing screws and screw caps.
2PT 980 680-801	1	Daytime running light set, 12V
2PT 980 680-851	1	Daytime running light set, 24V
		With 2500 mm long lead, fixing screws and screw caps.
2PT 980 680-001	1	Daytime running light, 12V
2PT 980 680-501	1	Daytime running light, 24V
		Spare parts/Accessories:
		Relay,
4RD 933 332-041	1	12V
4RD 933 332-061	1	24V

For flush mounting

In LED-technology. With 12 white LEDs 2.0W. Clear lens.

Consumption: 0.17A at 12V, 0.09A at 24V.

5 holes Ø 4.2 mm for fixing screws.

See LED instruction 2.

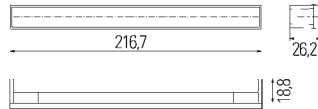

Part no.	Pk.	Contents:
		2 lights with 2500 mm long lead and relay.
2PT 980 680-821	1	Daytime running light set, 12V
2PT 980 680-861	1	Daytime running light set, 24V
<hr/>		
With 2500 mm long lead.		
2PT 980 680-101	1	Daytime running light, 12V
2PT 980 680-601	1	Daytime running light, 24V
Spare parts:		
Relay,		
4RD 933 332-041	1	12V
4RD 933 332-061	1	24V

For surface mounting

In LED-technology. With 8 white LEDs 2.0W. Clear lens.

Consumption: 0.17A at 12V, 0.08A at 24V.

Four 4.3 mm dia. holes for fixing screws.

See LED instruction 2.

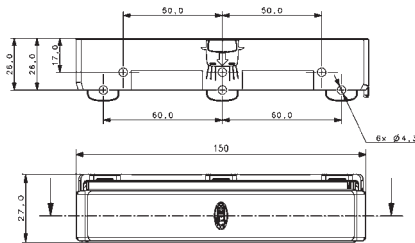

Part no.	Pk.	Contents:
		2 lights with lead, relay and bracket.
2PT 980 970-821	1	Daytime running light set, 12V
2PT 980 970-871	1	Daytime running light set, 24V
<hr/>		
With 2500 mm long lead.		
2PT 980 970-021	1	Daytime running light, 12V
2PT 980 970-521	1	Daytime running light, 24V
Spare parts/Accessories:		
Control unit,		
5DF 980 816-051	1	12V
5DF 980 816-551	1	24V
Relay,		
4RD 933 332-041	1	12V
4RD 933 332-061	1	24V
8HG 980 975-101	1	Bracket

For surface mounting

LEDayLine 30

In LED-technology. With 8 white LEDs 2.0W. Clear lens.
 For horizontal surface mounting with 30° mounting form.
 With polarity reversal protection.
 See LED instruction 2.

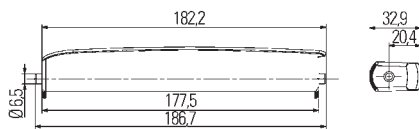

Part no.	Pk.	
		Contents: 2 lights, brackets, relay, 2800 mm long lead and fixing screws (suitable 4 fixing screws for rear mounting or 3 fixing screws for mounting on top).
2PT 980 850-801	1	Daytime running light set, 12V
2PT 980 850-851	1	Daytime running light set, 24V
		Accessories: LED-control unit,
5DF 980 816-001	1	12V
5DF 980 816-501	1	24V
		Without bracket.
2PT 980 850-001	1	Daytime running light, 12V
2PT 980 850-501	1	Daytime running light, 24V
		Accessories: Lead set with LED-control unit,
8KA 959 186-801	1	12V
8KA 959 186-811	1	24V
8HG 980 854-101	1	Bracket
		Relay,
4RD 933 332-041	1	12V
4RD 933 332-061	1	24V

For surface mounting

LEDayLine 15

In LED-technology. With 8 white LEDs 2.0W. Clear lens.
For horizontal surface mounting with 15° mounting form.
With polarity reversal protection. See LED instruction 2.

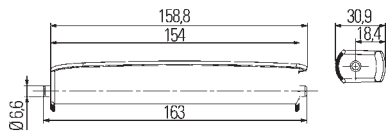

Part no.	Pk.	Contents:
2PT 980 860-801	1	Daytime running light set, 12V
2PT 980 860-851	1	Daytime running light set, 24V
Accessories:		
5DF 980 816-001	1	LED-control unit, 12V
5DF 980 816-501	1	LED-control unit, 24V
Without bracket.		
2PT 980 860-001	1	Daytime running light, 12V
2PT 980 860-501	1	Daytime running light, 24V
With 300 mm long lead and 2-pole AMP Superseal plug connector. Without supporting frame.		
2PT 980 860-557	60	Daytime running light, 24V
Accessories:		
8KA 959 186-801	1	Lead set with LED-control unit, 12V
8KA 959 186-811	1	Lead set with LED-control unit, 24V
8HG 980 864-101	1	Bracket set
4RD 933 332-041	1	Relay, 12V
4RD 933 332-061	1	Relay, 24V

In LED-technology. With 3 white LEDs. Clear lens.
Power consumption: 12V < 5.5W, 24V < 11.0W.
Consumption: 0.36A at 12V/24V.
Body made of silver-coloured aluminium.
Voltage range: 9V - 33V. See LED instruction 2.

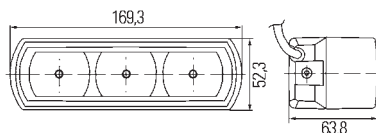
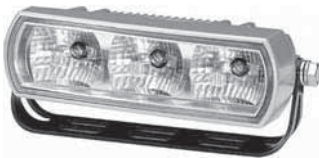

Part no.	Pk.	Contents:
2PT 009 496-801	1	Daytime running light set without position light
Without bracket, with 500 mm long lead set and Superseal plug connector.		
2PT 009 496-007	42	Daytime running light with position light
Accessories:		
8KA 165 959-001	1	Lead set, 2700/1800 mm long, with Superseal plugs, 3-pole, for connection 2 daytime running lights
8JA 746 184-032	10	Superseal plug, 3-pole
8KW 744 837-002	50	Jack contact for leads 1.0 - 1.5 sq. mm dia.
9GD 746 185-002	50	Strand insulation for lead outside 1.8 - 2.4 sq. mm dia.

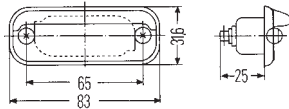

Clear lens.

For flush mounting above or below 520 x 120 mm (2 or 3 lights) and 340 x 240 mm (2 lights) licence plates. Depth required for flush fitting: 25 mm. With separate ground connection

Part no.	Pk.	
2KA 001 378-001	4	Licence plate light with chrome-plated rim and two M4 fixing screws
2KA 001 378-041	4	Licence plate light with silver-coloured finish, without fixing screws
2KA 001 378-127	1	Licence plate light with silver-coloured finish and 12V bulb, without fixing screws
2KA 001 378-207	100	without fixing screws, with blade terminal contacts angled 45°
8GM 002 092-121	10	Spare parts/Accessories: C5W bulb, 12V

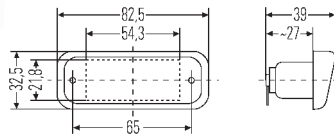

Clear lens.

For flush mounting above (2 lights) of 520 x 120 mm licence plates. Black plastic body. Depth required for flush fitting: 25 mm. With separate ground connection.

Part no.	Pk.	
2KA 005 049-008	18	Licence plate light with 12V bulb
2KA 005 049-011	2	with 24V bulb
2KA 005 049-017	42	
8GM 002 092-121	10	Spare parts: C5W bulb, 12V
8GM 002 092-241	10	24V



Clear lens. With 12V bulb.

For flush mounting above or below (1 light) 520 x 120 mm licence plates. Black plastic body. Two 4.5 mm dia. holes for fixing screws. For John Deere.

Part no.	Pk.	
2KA 003 738-057	1	Licence plate light
8GM 002 092-121	10	Spare parts: C5W bulb, 12V

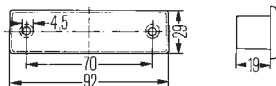

Clear lens. With 12V bulb.

For flush mounting above or below (2 lights) 520 x 120 mm licence plates. Depth required for flush fitting: 20 mm.

Part no.	Pk.	
2KA 004 331-061	5	Licence plate light with two holes for 4.5 mm dia. fixing screws
2KA 004 331-067	100	
2KA 004 331-107	100	with PC lens and two holes for B4.2 x 13 fixing screws
8GM 002 092-121	10	Spare parts: C5W bulb, 12V

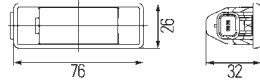

Clear lens. With 12V bulb.

For flush mounting above (2 lights) 520 x 120 mm licence plates.
Black plastic body. Lamp fastened with catch at side.

Part no.	Pk.	
2KA 008 224-307	440	Licence plate light
8GP 003 594-121	10	Spare parts: W5W bulb, 12V

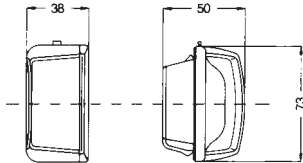

Clear lens.

For flush mounting. Plastic body with integrated bulb carrier.
Quick mount lens light fixed with snap mount.
With blade terminal contact.

Part no.	Pk.	
2KA 997 122-001	1	Licence plate light
8GA 002 071-131	10	Accessories: R10W bulb, 12V

In LED-technology. With 4 LEDs 1.0W. Clear lens.

Black plastic rim.
Two holes for St3.9 fixing screws.
Consumption: 0.08A at 12V, 0.04A at 24V.
See LED instruction 2.

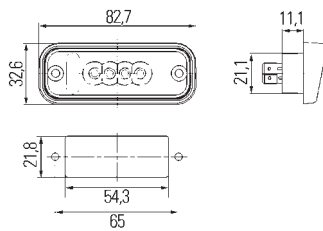

Part no.	Pk.	
		With blade terminal contact 6.3 x 0.8 mm. For flush mounting above or below (2 lights) 520 x 120 mm licence plates.
2KA 010 278-311	1	Licence plate light, 12V
2KA 010 278-317	196	
2KA 010 278-011	1	Licence plate light, 24V
2KA 010 278-017	196	
		With 1000 mm long lead. For flush mounting above or below (2 lights) 520 x 120 mm licence plates.
2KA 010 278-617	30	Licence plate light, 12V
2KA 010 278-607	30	Licence plate light, 24V
		With 150 mm long lead and 2-pole DEUTSCH plug connector. For flush mounting above or below (2 lights) 520 x 120 mm licence plates.
2KA 010 278-627	30	Licence plate light, 24V
		With blade terminal contact 6.3 x 0.8 mm. For flush mounting above or below 340 x 240 mm (1 light) licence plates.
2KA 010 278-411	1	Licence plate light, 12V
2KA 010 278-111	1	Licence plate light, 24V

Licence plate lights

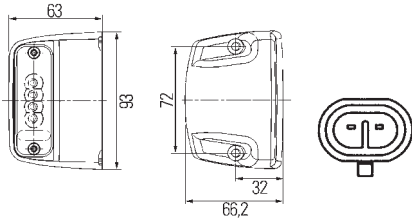

In LED-technology. With 4 LEDs 1.0W. Clear lens.

Consumption: 0.08A at 12V, 0.04A at 24V.

Black plastic body.

Two M5 x 35 fixing screws.

With blade terminal contact 6.3 x 0.8 mm.

See LED instruction 2.

Part no.	Pk.	
		For surface mounting to left or right of 520 x 120 mm licence plates (1 light).
2KA 010 278-321	1	Licence plate light, 12V
2KA 010 278-021	1	Licence plate light, 24V
		Licence plate light with 2000 mm long lead with blade receptacles 6.3 x 0.8mm, 24V
2KA 010 278-031	1	
		Licence plate light with 500 mm long lead and 2-pole EasyConn socket, 24V
2KA 010 278-051	1	
		Licence plate light with 2050 mm long lead and 2-pole AMP Superseal plug connector, 24V
2KA 010 278-081	1	
		For surface mounting to left or right of 340 x 240 mm licence plates (1 light).
2KA 010 278-421	1	Licence plate light, 12V
2KA 010 278-121	1	Licence plate light, 24V



In LED-technology. With 2 LEDs. Clear lens.
Power consumption: 12V0.3W, 24V0.6W.
 Consumption: 0.03A.
 Black plastic body.
 Two M5 x 35 fixing screws.
 Voltage range: 9V - 33V.
 See LED instruction 2.

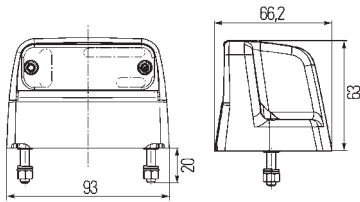

Part no.	Pk.	
2KA 012 271-031	1	Licence plate light with grey body and 2000 mm long lead with 6.3 mm blade terminals
2KA 012 271-037	36	
2KA 012 271-041	1	with grey body and 500 mm long lead with quick-link lead attachment
2KA 012 271-047	36	
2KA 012 271-051	1	with grey body and 500 mm long lead with 2-pole EasyConn socket
2KA 012 271-057	36	
2KA 012 271-061	1	with grey body and 1300 mm long lead with 2-pole AMP-Superseal plug connector
2KA 012 271-067	36	
2KA 012 271-081	1	with grey body and 2000 mm long lead with 2-pole AMP-Superseal plug connector
2KA 012 271-087	36	
2KA 012 271-071	1	with grey body and 1300 mm long lead with 2-pole EasyConn angular plug
2KA 012 271-077	36	
2KA 012 271-237	36	with white body and 2000 mm long lead with 6.3 mm blade terminals
2KA 012 271-277	36	with white body and 1300 mm long lead with 2-pin EasyConn plug connector

Clear lens.
 For surface mounting. Two M6 fixing screws.

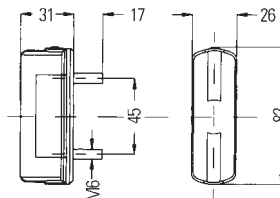

Part no.	Pk.	
2KA 997 011-011	1	Licence plate light with screw-contact and chrome-plated steel body and black steel body
2KA 997 011-001	1	
8GM 002 092-121	10	Accessories: C5W bulb, 12V
8GM 002 092-241	10	
2KA 997 011-021	1	Licence plate light with blade terminal contact and black plastic body
8GM 002 092-121	10	
8GM 002 092-241	10	Accessories: C5W bulb, 12V

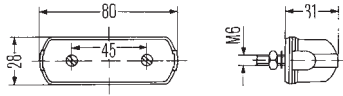
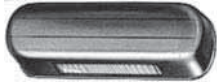

Clear lens. Black body.

For surface mounting above or below 520 x 120 mm (2 or 3 lights), 340 x 240 mm (2 lights) and 240 x 130 mm (1 light) licence plates, or mounting to left and right of 520 x 120 mm licence plates. Two M6 fixing screws.

Part no.	Pk.	
2KA 001 389-101	10	Licence plate light
Spare parts/Accessories:		
8GM 002 092-121	10	12V
8GM 002 092-241	10	24V

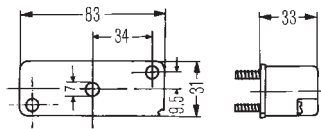

Clear lens. Black body.

Two B3.9 x 38 fixing screws.

Part no.	Pk.	
2KA 003 168-021	2	Licence plate light
Accessories:		
C5W bulb,		
8GM 002 092-121	10	12V
8GM 002 092-241	10	24V

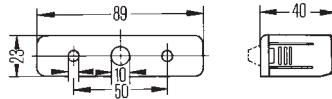

Clear lens. Black body.

For surface mounting above (2 lights) or mounting to left and right of 520 x 120 mm licence plates. Two 5.5 mm dia. holes for fixing screws.

Part no.	Pk.	
2KA 006 896-001	4	Licence plate light
2KA 006 896-007	102	
Accessories:		
C5W bulb,		
8GM 002 092-121	10	12V
8GM 002 092-241	10	24V

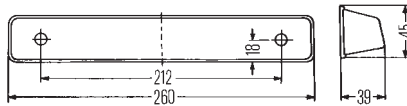

Clear lens. Silver coloured body.

For surface mounting above 520 x 120 mm or 340 x 240 mm licence plates. Two 4.5 mm dia. holes for fixing screws.

Part no.	Pk.	
2KA 001 610-001	1	Licence plate light
Accessories:		
C5W bulb, 12V		
8GM 002 092-121	10	

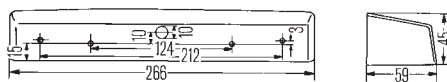

Clear lens. Black body.

For surface mounting above 520 x 120 mm or 340 x 240 mm licence plates. Four holes for B4.2 x 16 fixing screws.

Part no.	Pk.	
2KA 004 525-001	1	Licence plate light
Accessories:		
C5W bulb,		
8GM 002 092-121	10	12V
8GM 002 092-241	10	24V

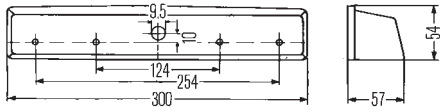

Clear lens. Silver coloured body.

For surface mounting above 520 x 120 mm or 340 x 240 mm licence plates. Four 5.5 mm dia. holes for fixing screws.

Part no.	Pk.	
2KA 001 622-001	2	Licence plate light
Spare parts/Accessories:		
9EL 108 651-001	2	Lens
8GM 002 092-121	10	C5W bulb, 12V

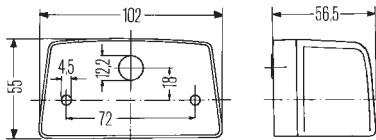

Black plastic body and base plate.

For surface mounting above or below 520 x 120 mm (1 or 2 lights) and 340 x 240 mm (1 light) licence plates, or mounting to left and right of 520 x 120 mm and 340 x 240 mm licence plates.

Bulb holder with vibration damping. Two holes for M5 fixing screws.

Part no.	Pk.	
2KA 998 523-001	1	Licence plate light for mounting above licence plates
2KA 998 523-007	160	
Spare parts/Accessories:		
8GA 002 071-131	10	R10W bulb, 12V
8GA 002 071-251	10	24V

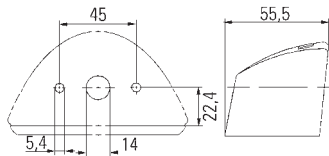

Rear-Logic

Clear lens. Black plastic body. With grommet.

For surface mounting above 340 x 240 mm and 520 x 120 mm (2 lights) licence plates or mounting to left and right of 340 x 240 mm and 520 x 120 mm licence plates.

Two 5.4 mm dia. holes for fixing screws.

Part no.	Pk.	
2KA 007 929-001	2	Licence plate light
2KA 007 929-007	72	
Accessories:		
8GM 002 092-121	10	C5W bulb, 12V
8GM 002 092-241	10	24V



Licence plate lights

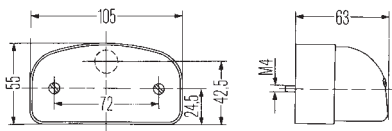
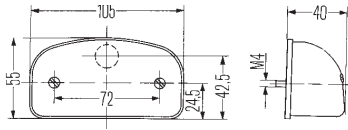

Clear lens.

For surface mounting to left and right of 520 x 120 mm and 340 x 240 mm licence plates.
With blade terminal contacts and grommet.

Part no.	Pk.	
2KA 001 386-231	2	Licence plate light with two 4.5 mm dia. holes for fixing screws and black body
2KA 001 386-281	2	with distance base and fixing material, black body, two AM4 x 40 fixing screws
2KA 001 386-497	120	with distance base and fixing material, black body, two AM4 x 40 fixing screws, with loss-protection for fixing screws
2KA 001 386-301	2	with distance base and fixing material, grey body, two AM4 x 40 fixing screws
Spare parts/Accessories:		
9BG 101 230-001	2	Body with lens, black
9GT 005 166-001	10	Grommet
8GM 002 092-121	10	C5W bulb, 12V

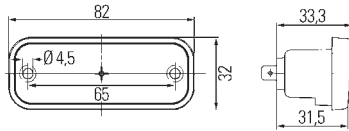

For side flush mounting

Clear lens.

Black plastic body, with rubber gasket.
Two 4.5 mm dia. holes for fixing screws.

Part no.	Pk.	
2XS 003 738-037	40	Clearance light
Spare parts:		
8GM 002 092-121	10	C5W bulb, 12V

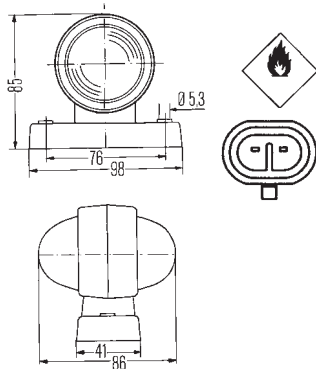

For upright mounting

Front-facing part of lens frosted white, rear-facing part red, provided loose.

Black rubber body. Light is pre-wired.
Two 5.3 mm dia. holes for fixing screws.

Part no.	Pk.	
2XS 955 031-001	2	Clearance light
2XS 955 031-017	100	with 150 mm long lead and 2-pole AMP Superseal plug connector
Spare parts/Accessories:		
9EL 950 315-061	5	red, for upright mounting
9EL 950 315-001	5	red, for pendant mounting
9EL 950 315-031	5	frosted white R5W bulb,
8GA 002 071-121	10	12V
8GA 002 071-241	10	24V

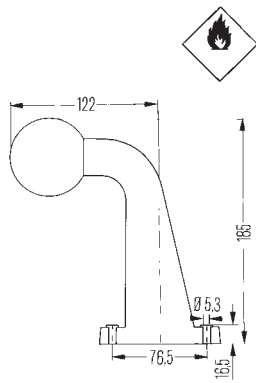

2XS 950 071-031	2	Clearance light with rubber arm
Spare parts/Accessories:		
9EL 950 315-061	5	red
9EL 950 315-031	5	frosted white
Lead		
8KA 950 073-001	10	with plastic bulb holder
8KA 962 886-001	10	with metal bulb holder
R5W bulb,		
8GA 002 071-121	10	12V
8GA 002 071-241	10	24V

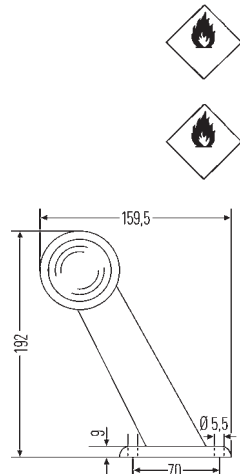

2XS 955 232-001	2	Clearance light with straight rubber arm and 75 mm long lead
with straight rubber arm, 150 mm long lead with flute tube, crimped blade connectors 6.3 mm and mounted plug body like AMP		
Spare parts/Accessories:		
9EL 950 315-061	5	red
9EL 950 315-031	5	frosted white
Lead		
8KA 950 073-001	10	with plastic bulb holder
8KA 962 886-001	10	with metal bulb holder
R5W bulb,		
8GA 002 071-121	10	12V
8GA 002 071-241	10	24V

For side mounting on trailer

Rear-Logic

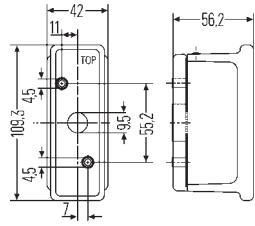

Front-facing part of lens clear, rear-facing part red, side marker light with integrated amber reflector.

Black plastic body, with grommet.

Two 4.5 mm dia. holes for fixing screws.

When the light is used on towing vehicles it is necessary to replace the glass-clear lens with a black lens 9EL 148 673-021, as accessory available.



Part no.	Pk.	
2XS 007 841-011	8	Clearance-side marker light with reflector, left
2XS 007 841-017	104	
2XS 007 841-021	8	right
Spare parts/Accessories:		
9EL 146 838-001	2	Side-marker light
9GT 005 166-001	10	Grommet
9EL 148 673-021	10	Lens, black R10W bulb,
8GA 002 071-131	10	12V
8GA 002 071-251	10	24V

For side upright mounting on trailer

Mounting on trailer with box body is prohibited.

Front-facing part of lens clear, rear-facing part red (not mounted), for side marker light with integrated amber reflector (mounted).

Black rubber body.

Four 5.3 mm dia. holes for fixing screws.

When the light is used on towing vehicles it is necessary to replace the glass-clear lens with a black lens 9EL 964 291-001, as accessory available.

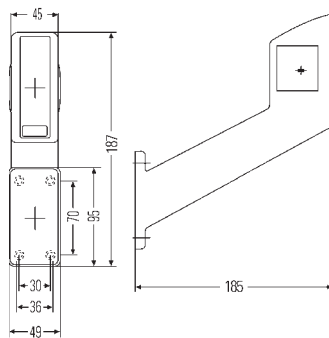
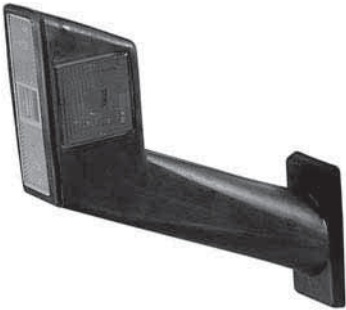

Part no.	Pk.	
2XS 955 260-001	2	Clearance-side marker light with reflector
2XS 955 260-007	50	
Spare parts/Accessories:		
9EL 964 289-001	10	Lens, clear
9EL 964 290-001	10	red
8RA 964 292-001	10	Reflector, amber R5W bulb,
8GA 002 071-121	10	12V
8GA 002 071-241	10	24V

For side-rear mounting

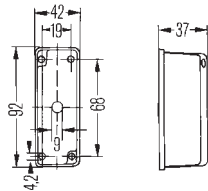

Part no.	Pk.	Description
2XS 005 020-001	10	Clearance light with two ST3.5 x 16-C fixing screws and grommet, without bulb, front lens clear, rear lens red
2XS 005 020-002	90	
2XS 005 020-003	1	
		Pro-fit pack



2XS 005 020-057	1	Clearance light with two ST3.5 x 16-C fixing screws, grommet and 12V bulb, front lens clear, rear lens red
-----------------	---	--



2XS 005 020-137	168	Clearance light without fixing screws and grommet, with 8.2 mm dia. hole for wire and 12V bulb front lens clear, rear lens red
-----------------	-----	--



2XS 005 020-041	10	Clearance light with two ST3.5 x 16-C fixing screws. and 8.2 mm dia. hole for wire, without grommet, front lens black, rear lens red
2XS 005 020-047	168	



2XS 005 020-081	2	Clearance light with two ST3.5 x 16-C fixing screws, 9 mm dia. hole for wire and grommet front lens black, rear lens red
-----------------	---	--



2XS 005 020-077	8	Clearance light with two ST3.5 x 16-C fixing screws. and 8.2 mm dia. hole for wire, without grommet, front lens clear, rear lens black
-----------------	---	--

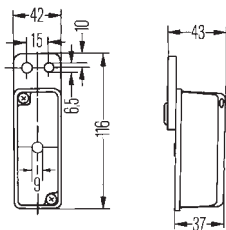

2XS 005 020-011	10	Clearance light with flexible rubber support 55 x 42 mm and grommet, front lens clear, rear lens red
2XS 005 020-017	140	



2XS 005 020-067	6	Clearance light with flexible rubber support 55 x 42 mm, without grommet, for PG9-lead retention, front lens clear, rear lens red
-----------------	---	---



2XS 005 020-091	2	Clearance light with flexible rubber support 55 x 42 mm and grommet, front lens black, rear lens red
-----------------	---	--

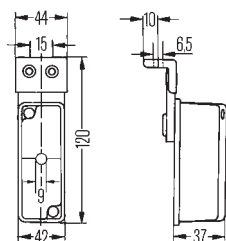

2XS 005 020-021	10	Clearance light with grommet and rubber holder with fixing angle, front lens clear, rear lens red
2XS 005 020-111	2	
2XS 005 020-121	1	

Spare parts/Accessories:		
Lens with screws,		
9EL 132 215-001	2	front-facing part clear, rear-facing part red
9EL 132 215-011	2	front-facing part black, rear-facing part red
T4W bulb,		
8GP 002 067-121	10	12V
8GP 002 067-241	10	24V

For side-rear mounting

Changeable against bulb versions 2XS 008 479-... and 2XS 005 020-...

In LED-technology. With 4 LEDs 0.6W.
Inner lens front clear, red rear,
outer lens clear.

Black plastic base plate.
Consumption: 0.05A at 12V, 0.03A at 24V.
Type of protection: IP6K9K.
All lights are suitable ADR.

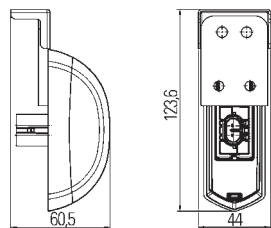
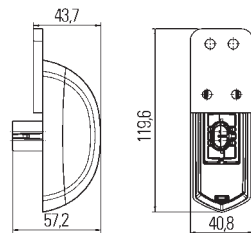
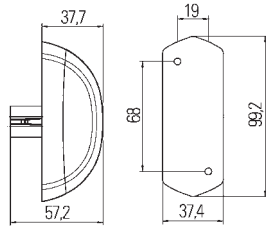

Part no.	Pk.	
		With 2-pole AMP-Superseal plug connector and two 4.2 mm dia. holes for fixing screws.
2XS 205 020-001	1	Clearance light, 12V
2XS 205 020-007	100	
2XS 205 020-011	1	Clearance light, 24V
2XS 205 020-017	100	
		With 500 mm long lead and two 6.5 mm dia. holes for fixing screws.
2XS 205 020-041	1	Clearance light, 12V
2XS 205 020-047	100	
2XS 205 020-051	1	Clearance light, 24V
2XS 205 020-057	100	
		With flexible rubber support, 2-pole AMP-Superseal plug connector and two 6.5 mm dia. holes for fixing screws.
2XS 205 020-121	1	Clearance light, 12V
2XS 205 020-127	80	
2XS 205 020-131	1	Clearance light, 24V
2XS 205 020-137	80	
		With flexible rubber support, 500 mm long lead and two 6.5 mm dia. holes for fixing screws.
2XS 205 020-151	1	Clearance light, 24V
2XS 205 020-157	80	
		With flexible rubber support, 3000 mm long lead and two 6.5 mm dia. holes for fixing screws.
2XS 205 020-171	1	Clearance light, 24V
2XS 205 020-177	56	
		With flexible rubber support with fixing angle, 2-pole AMP-Superseal plug connector and two 6.5 mm dia. holes for fixing screws.
2XS 205 020-021	1	Clearance light, 12V
2XS 205 020-027	80	
2XS 205 020-031	1	Clearance light, 24V
2XS 205 020-037	80	
8JA 746 184-022	10	Accessories: 2-pole AMP Superseal plug

For side mounting

For caravans.

Lens is arrested on base plate.

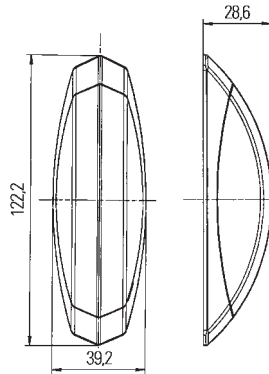

Part no.	Pk.	
2XS 008 479-061	1	Clearance light front-facing part of lens clear, rear-facing part red, without bulb, with dark grey base plate, left
2XS 008 479-071	1	right
2XS 008 479-001	1	Clearance light front-facing part of lens clear, rear-facing part red, with 12V bulb, with dark grey base plate, left
2XS 008 479-007	90	
2XS 008 479-011	1	right
2XS 008 479-017	90	
2XS 008 479-081	1	Clearance light front-facing part of lens clear, rear-facing part red, with 12V bulb, with white base plate, left
2XS 008 479-087	90	
2XS 008 479-091	1	right
2XS 008 479-097	90	
2XS 008 479-041	1	Clearance light front-facing part of lens clear, rear-facing part red, with 24V bulb, with dark grey base plate, left
2XS 008 479-047	90	
2XS 008 479-051	1	right
2XS 008 479-057	90	
2XS 008 479-107	90	Clearance light front-facing part silver coloured, rear-facing part of lens red, with 12V bulb, with light dark base plate, left
2XS 008 479-117	90	right
8GM 002 092-121	10	Spare parts: C5W bulb, 12V
8GM 002 092-241	10	24V

For side, horizontal or vertical surface mounting

For horizontal or vertical surface mounting on trailers and semi-trailers with box body.

With 2 red LEDs and grommet.

Lens clear. With LED light guide technology.

Consumption: 0.06A at 12V/24V.

Grey plastic base plate and covers.

Two 5.4 mm dia. holes for fixing screws.

for fixing screws.

See LED instruction 2.

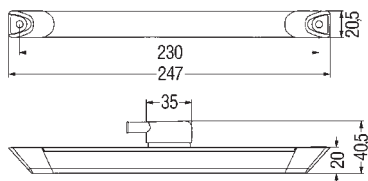

Part no.	Pk.	
2XS 008 078-011	1	Clearance light, 12V0.7W
2XS 008 078-001	1	24V1.4W
2XS 008 078-007	60	

For side mounting

Front-facing part of lens frosted white.
National type test for Germany

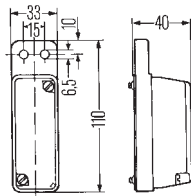
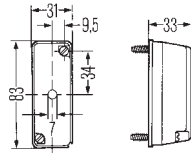

Part no.	Pk.	
2XS 003 168-071	2	Track-control light with two 3.9 x 32 fixing screws
2XS 003 168-081	2	with flexible rubber support and two 6.5 mm dia. holes for fixing screws
8GM 002 092-121	10	Accessories: C5W bulb, 12V
8GM 002 092-241	10	

For mounting to vertical and horizontal surfaces

Bracket with M8 fixing screw.

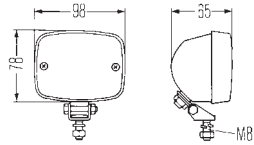
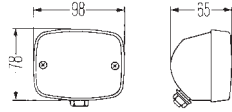

Part no.	Pk.	
2NE 003 030-167	12	Red lens. Rear fog light (NES 100) with 12 bulb and matt black body
2NE 003 030-151	1	Rear fog light (NES 100) with chrome-plated body
8GA 002 073-121	10	Spare parts/Accessories: P21W bulb, 12V
8GA 002 073-241	10	24V
2ZR 003 030-171	1	Clear lens. Reverse light (ZR 100) with chrome-plated body
8GA 002 073-121	10	Spare parts/Accessories: P21W bulb, 12V
8GA 002 073-241	10	24V

Bracket with M8 fixing screw.

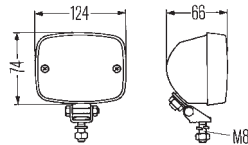

Part no.	Pk.	
2NE 002 985-001	1	Red lens. Rear fog light (NES 80) with black body
8GA 002 073-121	10	Spare parts/Accessories: P21W bulb, 12V
8GA 002 073-241	10	24V
2ZR 002 985-081	1	Clear lens. Reverse light (ZR 80) with chrome-plated body
2ZR 002 985-261	1	Reverse light (ZR 80) with black body
2PF 002 985-291	2	For front mounting. Amber lens. Daytime running light with black body
8GA 002 073-121	10	Accessories: P21W bulb, 12V
8GA 002 073-241	10	24V

Rear fog and reverse lights



For surface mounting

Black plastic body and rim.
Two B4.8 x 19 fixing screws.

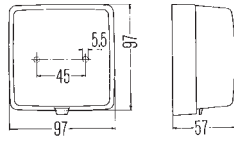
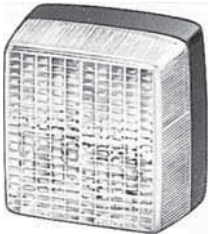

Part no.	Pk.	
		Red lens.
2NE 003 315-011	1	Rear fog lights (NES 9)
		Spare parts/Accessories:
9EL 119 977-001	1	Lens
8GA 002 073-121	10	P21W bulb, 12V
		Clear lens.
2ZR 003 315-041	1	Reverse light (ZR 9)
		Accessories:
8GA 002 073-121	10	P21W bulb, 12V

For surface or flush mounting

Black plastic body.
Two 5.2 mm dia. holes for fixing screws.

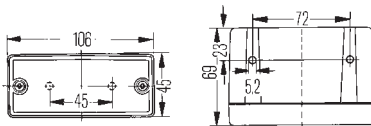
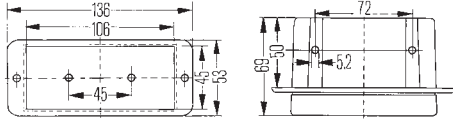
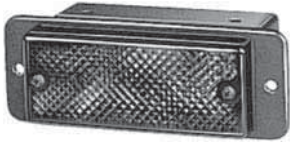

Part no.	Pk.	
		For horizontal or vertical flush mounting. Red lens.
2NE 006 609-017	25	Rear fog light
2NE 006 609-011	1	Rear fog light Pro-fit pack
2NE 006 609-197	25	Rear fog light without 12V bulb
		Spare parts/Accessories:
9EL 141 612-001	10	Lens
8GA 002 073-121	10	P21W bulb, 12V
		For horizontal or vertical flush mounting. Clear lens.
2ZR 006 609-171	1	Reverse light
		Accessories:
8GA 002 073-121	10	P21W bulb, 12V
		For horizontal or vertical attachment at rear or vertical attachment on side of passenger car trailer. Red lens.
2NE 006 609-007	30	Rear fog light
2NE 006 609-001	1	Rear fog light Pro-fit pack
2NE 006 609-187	30	Rear fog light without 12V bulb
		Spare parts/Accessories:
9EL 141 612-001	10	Lens
8GA 002 073-121	10	P21W bulb, 12V
		For rear surface mounting. Clear lens.
2ZR 006 609-087	30	Reverse light
2ZR 006 609-081	1	Reverse light Pro-fit pack
		Accessories:
8GA 002 073-121	10	P21W bulb, 12V

For flush mounting

Red PC lens with reflector.

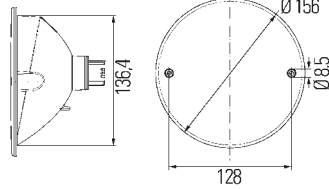

Part no.	Pk.	
2NE 344 610-007	36	Rear fog light with 12V bulb and 200 mm long lead with 6.3 mm blade terminals
2NE 344 610-037	36	with 12V bulb, 200 mm long lead with 6.3 mm blade terminals and clear isolation
2NE 344 610-027	36	with 12V bulb, 200 mm long lead and 2-pole Delphi plug connector
8GA 002 073-121	10	Spare parts: P21W bulb, 12V
8JD 156 150-807	1	Plug-set for -027
8RA 344 610-017	45	Reflector, red

For upright or pendant mounting

Modul 70 Gen. III LED

In LED-technology. With 4 Power LEDs and 2000 mm long lead.
Clear lens.

4-part reflector made of plastic, glued to glass lens without optical pattern.

Grey aluminium body.

Pivot base with M10 fixing screw.

Type of protection: IP6k7, IP6K9K.

Voltage range: 12V - 24V, 13W.

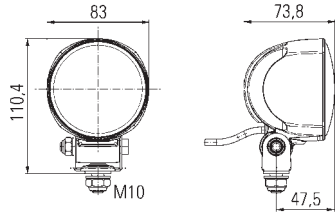

Part no.	Pk.	
2ZR 996 376-091	1	Reverse light

With 24V bulb.

Black fibre-glass reinforced plastic body.

With M10 fixing screw and vibration damping.

Type of protection: IP6K4K and IPX9K.

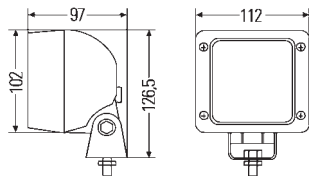

Part no.	Pk.	
2ZR 997 506-391	1	Reverse light (Ultra Beam FF) with 2-pole AMP plug connector and clear lens
2ZR 996 506-501	1	and clear lens, in half without optical pattern
2ZR 997 506-621	1	
2ZR 997 506-691	1	Reverse light (Ultra Beam FF) with 2-pole DEUTSCH plug connector
Spare parts/Accessories:		
9GH 993 984-001	20	Cap for AMP plug connector
8JD 008 151-011	10	Socket for AMP plug connector
8KB 990 299-001	1	2000 mm long lead for AMP plug connector
8KW 701 235-033	100	Blade receptacles 6.3 mm
8GH 002 090-133	1	H3 bulb, 12V
8GH 002 090-251	1	H3 bulb, 24V

For upright or pendant mounting

In LED-technology. Clear lens.

Black plastic body.
 Bracket with M10 fixing screw.
 Voltage range: 12V - 24V.
 Consumption with 1 LED: 0.42A at 12V, 0.21A at 24V.
 Consumption with 3 LEDs: 0.9A at 12V, 0.45A at 24V.
 Type of protection: IP6K9K. All lights are suitable ADR.
 See LED instruction 3.



2ZR 012 456-001
 2ZR 012 456-007

1
 12

Reverse light
 with 1 LED 5.0W
 and 2000 mm long lead
 with 2-pole AMP Superseal plug connector



2ZR 012 456-011
 2ZR 012 456-017

1
 12

and 1000 mm long lead with
 2-pole EasyConn plug connector,
 angled 90°

2ZR 012 456-021
 2ZR 012 456-027

1
 12

and 3500 mm long lead
 with 6.3 mm blade terminals

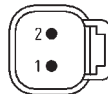

2ZR 012 456-031
 2ZR 012 456-037

1
 24

and 500 mm long lead with
 2-pole Amphenol plug connector



2ZR 012 456-201
 2ZR 012 456-207

1
 12

Reverse light
 with 3 LEDs 12.0W
 and 2000 mm long lead
 with 2-pole AMP Superseal plug connector



2ZR 012 456-211
 2ZR 012 456-217

1
 12

and 1000 mm long lead with
 2-pole EasyConn plug connector,
 angled 90°

2ZR 012 456-221
 2ZR 012 456-227

1
 12

and 3500 mm long lead
 with 6.3 mm blade terminals

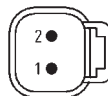

2ZR 012 456-231
 2ZR 012 456-237

1
 24

and 500 mm long lead with
 2-pole Amphenol plug connector

For upright or pendant mounting

Power Beam 1000

In LED-technology. With 6 LEDs 18W.

6-part reflector made of plastic, glued to plastic lens.

Black finish aluminium body with cooling ribs.

Rear of body made of blue plastic.

Heavy Duty bracket with M10 fixing screw

Voltage range: 12V - 24V.

Consumption: 0.67A at 12V, 0.34A at 24V.

Type of protection: IP6K9Kand IPX7. All lights are suitable ADR.

See LED instruction 3.

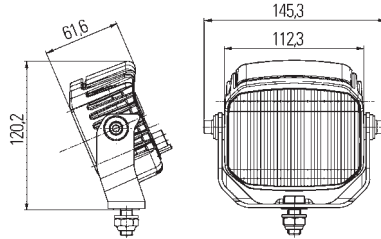

Part no.	Pk.	
2ZR 996 188-061	1	Reverse light with wide range illumination, with 2-pole DEUTSCH plug connector
2ZR 996 188-091	1	Reverse light with close-range illumination, with 2000 mm long lead and 2-pole DEUTSCH plug connector
2ZR 996 188-121	1	without lead, with 2-pole DEUTSCH plug connector and increased corrosion protection of the body cover
8KB 990 299-011	1	Accessories: 2000 mm long connecting lead for DEUTSCH plug connector with cap
8JA 990 295-127	10	2-pole DEUTSCH plug

2

For upright or pendant mounting, for pendant mounting must the angle of inclination be adjusted

Power Beam 500 RFSW

In LED-technology. With 30 LEDs and 2000 mm long lead.

Reflector glued to polished plastic lens.

Black shiny, hardened plastic body.

With polarity reversal protection.

Voltage range: 12V - 24V, 7.0W.

Type of protection: IP67, IP6K9K.

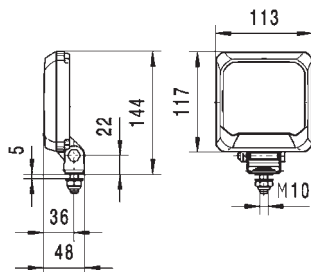

Part no.	Pk.	
2ZR 995 193-051	1	Reverse light, 550 lm

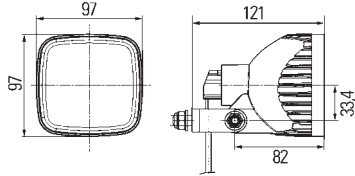

For upright mounting

Clear lens without optical pattern.
 With 500 mm long lead and 24V bulb.
 Black plastic body.
 Pivot base with M10 fixing screws.
 Type of protection: IP5K9K.

Part no.	Pk.	
2ZR 996 179-701	1	Reverse light (ECO 21)
Spare parts/Accessories:		
8GA 002 073-121	10	P21W bulb, 12V
8GA 002 073-241	10	24V

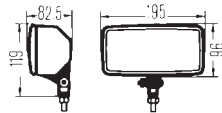

For upright mounting, also for pendant mounting after turning insert

Clear lens.
 Black plastic body.
 Pivot base with M10 fixing screws.
 Type of protection: IP5K4K

Part no.	Pk.	
2ZR 005 700-191	1	Reverse light (Comet 550)
Accessories:		
8GH 002 090-133	1	H3 bulb, 12V
8GH 002 090-251	1	24V

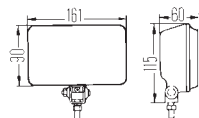

Clear lens.
 Black plastic body.
 Pivot base with M10 fixing screws.
 Type of protection: IP5K4K

Part no.	Pk.	
2ZR 005 860-151	1	Reverse light (Comet 450)
Accessories:		
8GH 002 090-133	1	H3 bulb, 12V
8GH 002 090-251	1	24V

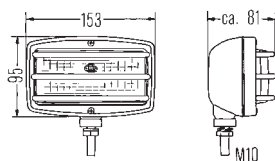
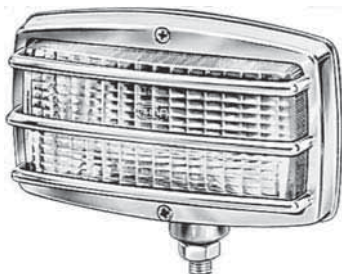

Clear lens.
 Black body, chrome-plated rim and protective grill.
 Spherical base with M10 x 1 hollow screw.

Part no.	Pk.	
2ZR 004 542-001	1	Reverse light (ZR 138)
Accessories:		
8GA 002 073-121	10	P21W bulb, 12V

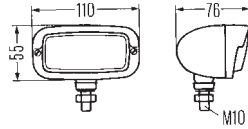
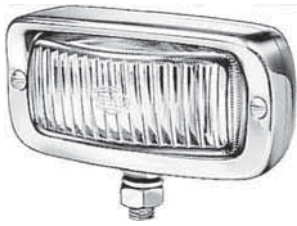

For attachment to bumper or horizontal surfaces

Clear lens.

Chrome-plated body and rim. Spherical base with M10 hollow screw.

Part no.	Pk.	
2ZR 001 193-011	1	Reverse light (ZR 92)
8GA 002 073-121	10	Accessories: P21W bulb, 12V

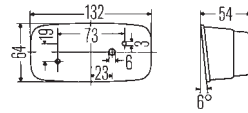

For surface mounting

Clear lens. With 12V bulb.

Chrome-plated rim. Two B4.2 x 13 fixing screws.

Part no.	Pk.	
2ZR 002 694-001	1	Reverse light (ZR 106)
9EL 113 928-001	2	Spare parts: Lens with screws
8GA 002 073-121	10	P21W bulb, 12V

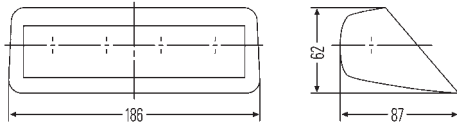

For stick-down attachment to inside surface

In Matrix-technology. Red lens.
With 12V bulbs and mounting accessories.
Black body. For rear window inclination 26° - 75°.

Part no.	Pk.	
2DA 007 428-001	1	Safety brake light,
2DA 007 428-007	40	
8GP 003 594-121	10	Spare parts: W5W bulb, 12V

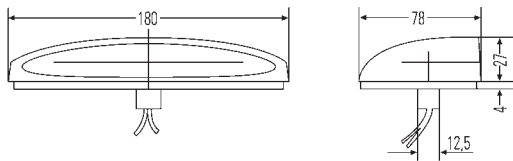

For surface-mounting on boot lid or vehicle roof

In Matrix-technology. Red lens.
With 12V bulbs and mounting accessories.

Part no.	Pk.	
2DA 007 541-001	1	Safety brake light,
8GP 003 594-121	10	Spare parts: W5W bulb, 12V

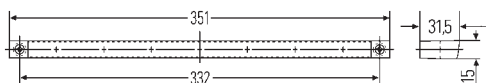
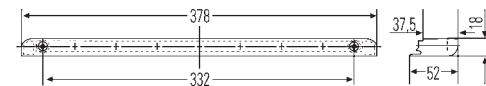
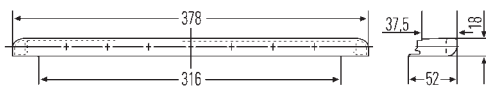
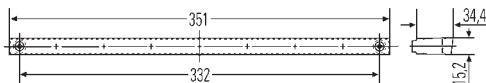

For flush mounting in rear spoiler

In Matrix-technology. Red lens. With 12V bulbs.
Black body. Without lead.

Part no.	Pk.	
2DA 007 421-001	1	Two B3.9 x 22 fixing screws with red head.
2DA 007 421-007	56	Safety brake light to screw attachment from the front
2DA 007 421-017	1	With rounded lens. Two B3.9 x 22 fixing screws with red head.
2DA 007 421-027	1	Safety brake light for screw-attachment from below
2DA 007 421-027	1	Safety brake light to screw attachment from the front
2DA 005 739-111	1	Two 6 mm dia. holes for fixing screws.
2DA 005 739-117	56	Safety brake light to screw attachment from the front
8KA 144 707-007	56	Spare parts/Accessories: Lead 200 mm long, without seal 800 mm long,
8KA 146 751-007	56	with seal of the electrical connection
8KA 146 751-017	250	380 mm long, with blade receptacles 3.6 mm
9GT 146 757-007	1000	Grommet
8GP 938 026-001	10	W2.3W bulb, 12V

For flush mounting in rear spoiler

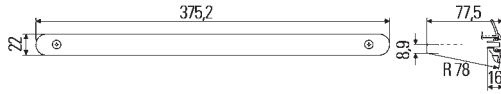

In LED-technology. With 20 red LEDs 12V3.0W. Clear lens.

Consumption: 0.25A at 12V.
Two ST3.9 x 22 fixing screws. Mounting from outside.
See LED instruction 2.

Part no.	Pk.	
2DA 007 858-037	1	Safety brake light,
		Accessories:
8KA 146 751-007	56	Lead with grommet

For flush mounting

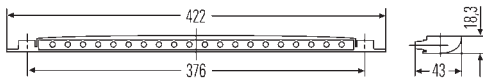

In LED-technology. With 20 LEDs 12V3.0W and 3500 mm long lead.

Consumption: 0.25A at 12V.
See LED instruction 2.

Part no.	Pk.	
2DA 959 580-151	1	Safety brake light, with red lens
2DA 959 580-551	1	with grey lens

In LED-technology. With 12 LEDs and 2500 mm long lead.

Consumption: 0.16A at 12V, 0.08A at 24V.
See LED instruction 2.

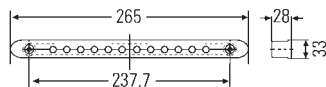
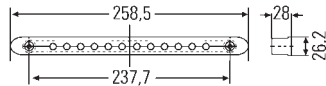

Part no.	Pk.	
2DA 959 071-037	1	Safety brake light, with clear lens, 12V2.0W
2DA 959 071-237	1	with clear lens, 24V2.0W
2DA 959 071-537	1	with red lens, 12V2.0W
2DA 959 071-737	10	with red lens, 24V2.0W
2DA 959 071-757	10	with installation material and red lens, 24V2.0W
2DA 959 071-787	10	with Superseal plug connector, included loose and red lens, 24V2.0W

For flush mounting in caravan-trailers and mobile homes

In Matrix-technology. Red lens. With 12V bulbs.

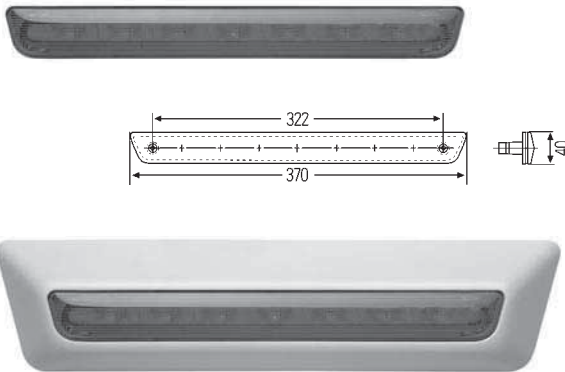

Part no.	Pk.	
2DA 008 136-007	60	Safety brake light, with screw-connected to the body
2DA 008 136-017	60	without screws, with screw-connected to the lens
2DA 008 136-027	60	with PE foam gasket coated with glue on both sides
2DA 008 136-031	1	with body, wiring harness and sealant
Spare parts/Accessories:		
		Lead
8KA 146 751-007	56	with grommet
8KA 144 707-007	56	without grommet
9GT 146 757-007	1000	Grommet
9BG 154 271-001	2	Body
8GP 938 026-001	10	W2.3W bulb, 12V

For horizontal surface mounting

In LED-technology. With 12 LEDs.

Lens with brilliant look with 3D effect by embedding each LED in a separate reflector.

Consumption: 0.15A at 12V, 0.30A at 24V.

Two holes for fixing screws.

See LED instruction 2.

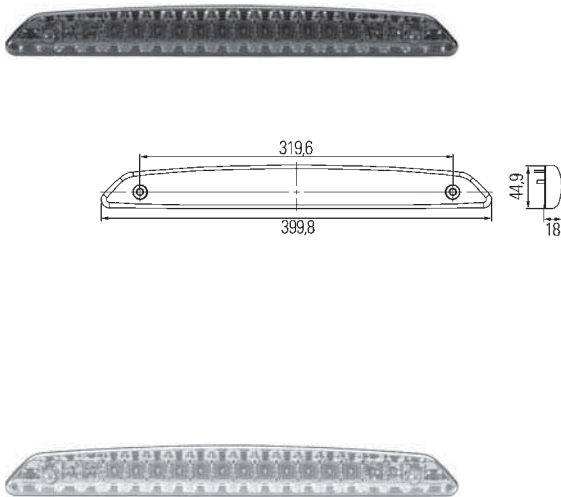

Part no.	Pk.	
2DA 343 800-001	1	With 200 mm long lead, red lens and red body.
2DA 343 800-007	48	Safety brake light, 12V1.8W
<hr/>		
With 235 mm long lead, red lens and red body.		
2DA 343 800-077	48	Safety brake light, 12V1.8W
<hr/>		
With 200 mm long lead, red lens, red body and with seal fixed in place by double-sided adhesive tape.		
2DA 343 800-057	48	Safety brake light, 12V1.8W
2DA 343 800-047	48	Safety brake light, 24V3.6W
<hr/>		
With 200 mm long lead, clear lens and white body.		
2DA 343 800-027	48	Safety brake light, 12V1.8W

For horizontal or vertical surface mounting

In LED-technology. With 10 LEDs.

Consumption: 0.06A at 12V/24V.

See LED instruction 2.

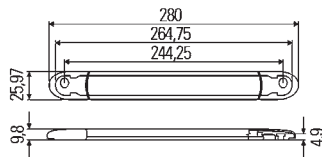

Part no.	Pk.	
		With 3000 mm long lead. Red lens coloured cap, two 3 mm dia. holes for fixing screws.
2DA 343 106-001	1	Safety brake light, 12V0.7W
2DA 343 106-007	30	
2DA 343 106-011	1	Safety brake light, 24V1.4W
2DA 343 106-017	30	
		With 7000 mm long lead. Red lens coloured cap, two 3 mm dia. holes for fixing screws.
2DA 343 106-047	30	Safety brake light, 12V0.7W
		With 3000 mm long lead. Red lens coloured cap, self-adhesive.
2DA 343 106-201	1	Safety brake light, 12V0.7W
2DA 343 106-207	30	
2DA 343 106-211	1	Safety brake light, 24V1.4W
2DA 343 106-217	30	
		With 3000 mm long lead. Smoked lens coloured cap, two 3 mm dia. holes for fixing screws.
2DA 343 106-021	1	Safety brake light, 12V0.7W
2DA 343 106-027	30	
2DA 343 106-031	1	Safety brake light, 24V1.4W
2DA 343 106-037	30	
		With 3000 mm long lead. Smoked lens coloured cap, self-adhesive.
2DA 343 106-221	1	Safety brake light, 12V0.7W
2DA 343 106-227	30	
2DA 343 106-231	1	Safety brake light, 24V1.4W

For horizontal or vertical surface mounting

In LED-technology. Red lens.
With double-sided adhesive tape and 200 mm long lead
with 6.3 mm blade terminals.

Consumption: 0.12A at 12V, 0.04A at 24V.

Type of protection: IP67.

See LED instruction 2.

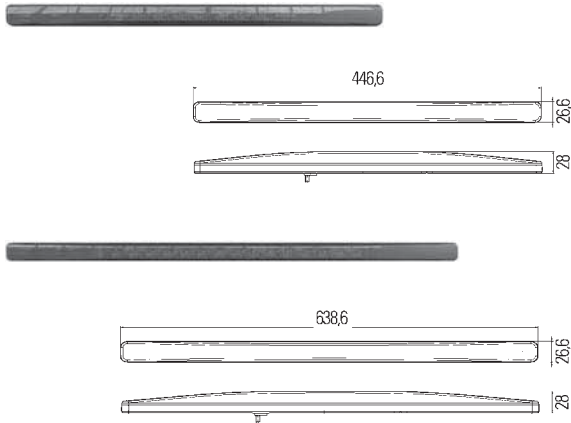

Part no.	Pk.	
		Safety brake light with 8 LEDs,
2DA 012 596-007	80	12V1.7W
2DA 012 596-017	80	24V1.7W
<hr/>		
		Safety brake light with 16 LEDs,
2DA 012 596-027	80	12V1.7W
2DA 012 596-037	80	24V1.7W



Front direction indicators

Category	Interval to dipped beam headlamp/front fog lamp	Luminous	Direction
1	> 40 mm	min. 175 cd	Towards front
1a	< 40 mm and > 20 mm	min. 250 cd	
1b	< 20 mm	min. 400 cd	

Front side direction indicators

Category	Replaces category	To be mounted with category	Luminous	Direction
3*)	1, 5 and 2a	-	min. 175 cd min. 50 cd	Towards front Towards rear
4*)	1 and 5	2a	min. 175 cd min. 0.6 cd	Towards front Towards rear

Side direction indicators

Category	Replaces category	To be mounted with category	Luminous	Direction
5	-	1 (1a) (1b) and 2a	min. 0.6 cd	Towards rear side
6	-	1 (1a) (1b) and 2a	min. 50 cd	

Rear direction indicators

Category	Remarks	Luminous	Direction
2a	One luminous intensity for day and night	min. 50 cd	Towards rear
2b	at day	min. 175 cd	Towards rear
	at night	min. 40 cd	Towards rear

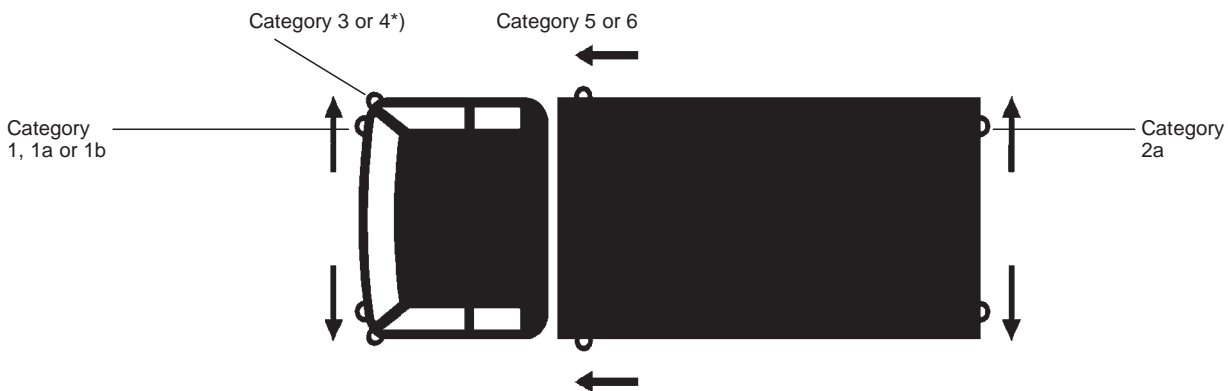

Meaning of arrow on direction indicators

- With arrow** Mounting is permissible on one side only (left or right)
- Without arrow** Mounting is permissible on left or right

*) Only usable, if vehicle is approved for use in Germany, e.g. farm vehicles and machines.

For surface mounting

Black plastic body.

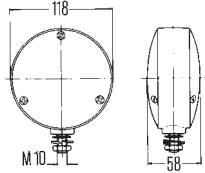

Part no.	Pk.	
		For front, front/side or rear mounting (category 1, 2a, 3 and 4). Amber lens. M10 hollow screw for fixing.
2BA 003 022-021	1	Indicator light without bulb, without lead
2BA 003 022-001	1	Indicator light without bulb, with 146 mm long lead with blade receptacle 6,3 mm and 170 mm long lead with cable connector
2BA 003 022-037	32	Indicator light with 12V bulb and 500 mm long lead with blade receptacles 6.3 mm
		Spare parts/Accessories:
9EL 116 907-001	1	Lens
9FT 117 109-007	1500	Bulb holder P21W bulb,
8GA 002 073-121	10	12V
8GA 002 073-241	10	24V
		Indicator light for school buses.
		Indicator light without bulb, without lead
		Spare parts/Accessories:
9EL 116 907-001	1	Lens
9FT 117 109-007	1500	Bulb holder
8GA 002 073-121	10	P21W bulb, 12V

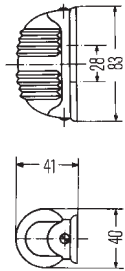
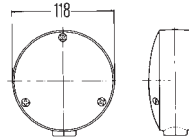

For front, side or rear mounting.

Amber lens.

Two M4 fixing screws.

National type test for Germany.

Part no.	Pk.	
2BA 001 227-201	2	Indicator light with chrome-plated rim
2BA 001 227-211	2	without chrome-plated rim
		Spare parts/Accessories:
		Lens
9EL 074 484-011	1	for -201
9EL 074 484-031	2	for -211
8GM 002 091-121	10	K bulb, 12V

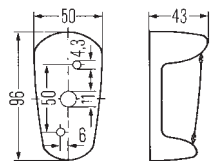

For front, side or rear mounting.

Amber lens.

Die-cast body, silver coloured.

2 M4 fixing screws.

National type test for Germany.

Part no.	Pk.	
2BA 001 248-001	4	Indicator light
		Accessories:
8GM 002 091-121	10	K bulb, 12V

For surface mounting

Amber lens.

Two holes for M5 fixing screws

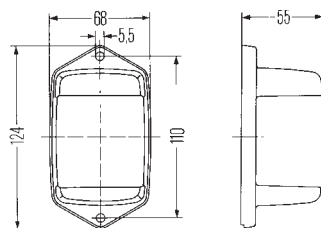
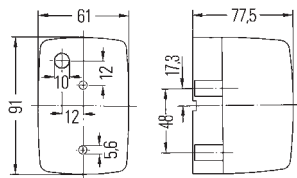
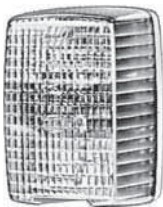
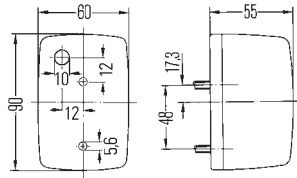
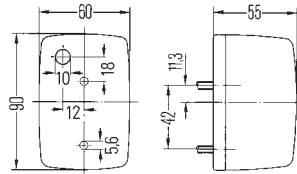

Part no.	Pk.	
		For front mounting (category 1). With grommet.
2BA 002 652-101	2	Indicator light
2BA 002 652-107	96	
		Spare parts/Accessories:
9EL 134 658-001	2	Lens with screw
8GA 002 073-121	10	P21W bulb, 12V
8GA 002 073-241	10	24V
		For front/side mounting (category 1, 4 and 5). With grommet.
2BA 002 652-111	2	Indicator light, left
2BA 002 652-117	96	
2BA 002 652-121	2	Indicator light, right
2BA 002 652-127	96	
		Spare parts/Accessories:
9EL 134 659-001	2	Lens with screw, left
9EL 134 660-001	2	right
8GA 002 073-121	10	P21W bulb, 12V
8GA 002 073-241	10	24V
		For side mounting. (category 5). With grommet. For Claas.
2BM 002 652-031	1	Auxiliary indicator
		Accessories:
8GA 002 071-121	10	R5W bulb, 12V
8GA 002 071-241	10	24V
		For side mounting. (category 5). With black base plate. Without grommet.
2BM 002 652-051	1	Auxiliary indicator
		Accessories:
8GA 002 073-121	10	P21W bulb, 12V
8GA 002 073-241	10	24V
		Silver coloured, for lights in model range 2BA 002 652-...
8XS 113 389-001	2	Protective cap

For surface mounting

Amber lens.

Two holes for B4.2 x 9.5 fixing screws.

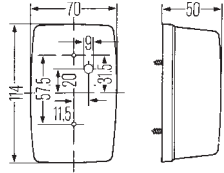

Part no.	Pk.	
For front mounting (category 1).		
2BA 002 324-001	1	Indicator light
Spare parts/Accessories:		
8GA 002 073-121	10	P21W bulb, 12V
8GA 002 073-241	10	24V
For front/side mounting (category 3 and 4 for Germany), with additional filter.		
2BA 002 324-011	1	Indicator light, left
2BA 002 324-021	1	Indicator light, right
Spare parts/Accessories:		
8GA 002 073-121	10	P21W bulb, 12V
8GA 002 073-241	10	24V

For front/side mounting (category 4 for Germany).

Amber lens.

Two holes for 4.2 fixing screws.

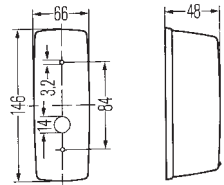

Part no.	Pk.	
2BA 001 277-011	1	Indicator light, left
2BA 001 277-021	1	right
Accessories:		
8GA 002 073-121	10	P21W bulb, 12V
8GA 002 073-241	10	24V

For front/side mounting (category 1, 4 and 5).

Amber lens.

Two holes for B4.2 x 13 fixing screws.

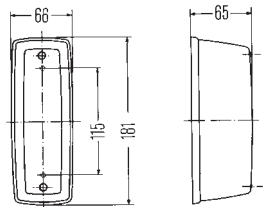

Part no.	Pk.	
2BA 001 221-031	4	Indicator light, left
2BA 001 221-041	4	right
Spare parts/Accessories:		
9EL 110 013-001	4	Lens with screws, left
9EL 110 014-001	4	right
8GA 002 073-121	10	P21W bulb, 12V

For front and rear mounting.

Amber lens.

For Fendt. National type test for Germany



Part no.	Pk.	
2BA 001 244-001	5	Indicator light
Spare parts/Accessories:		
9EL 085 478-001	5	Body with lens
8GM 002 091-121	10	K bulb, 12V

For surface mounting

For front/side mounting (category 1 and 4).
Amber lens.

Two holes for M6 fixing screws.

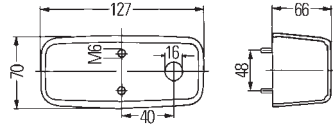

Part no.	Pk.	
2BA 001 416-011	1	Indicator light, left
2BA 001 416-021	1	right
Spare parts/Accessories:		
Lens with screws,		
9EL 110 737-001	2	left
9EL 110 736-001	2	right
P21W bulb,		
8GA 002 073-121	10	12V
8GA 002 073-241	10	24V

For flush mounting

For front or rear mounting (category 1 and 2a).
Amber lens.

Grey plastic body.

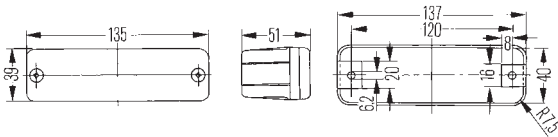

Part no.	Pk.	
2BA 002 939-251	1	Indicator light
Accessories:		
8GA 002 073-121	10	P21W bulb, 12V

For horizontal flush mounting

For front, side or rear flush mounting (category 1, 2a and 5).
Amber lens.

Black plastic body.

Two holes for B4.s or M4 fixing screws.

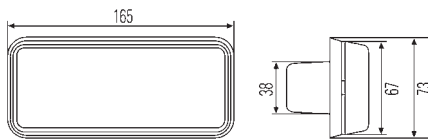

Part no.	Pk.	
2BA 996 027-001	1	Indicator light
Spare parts/Accessories:		
P21W bulb,		
8GA 002 073-121	10	12V
8GA 002 073-241	10	24V

For flush mounting

For front mounting (category 1).
In LED-technology. With 1 LED 3.0W, 200 mm long lead and three fixing screws with cover caps.

Consumption: 0.25A at 12V, 0.125A at 24V.
 Voltage range: 9V - 33V. Type of protection: IP6K.
 See LED instruction 3.

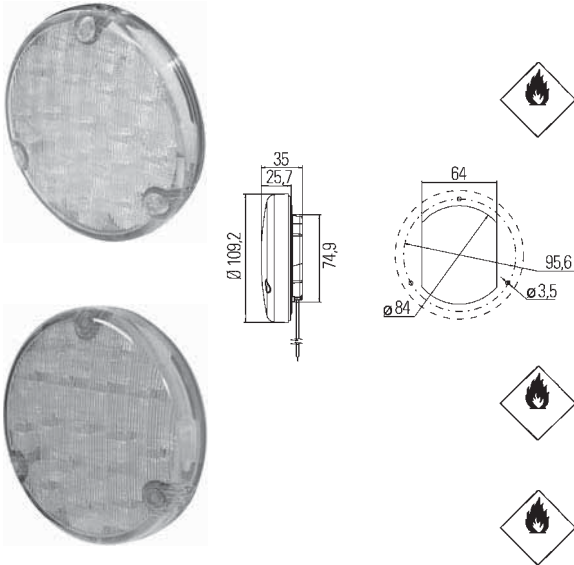

Part no.	Pk.	
2BA 959 932-051	1	Indicator light with clear PC lens
2BA 959 932-011	1	with amber PC lens
2BE 959 932-131	1	Indicator-position light with clear PC lens

For surface mounting

Without patented electronics for indicator failure check. Indicator failure check is not mandatory for lifting loading platforms. For rear mounting (category 2a) of liftype loading platforms. In LED-technology.

With 2 amber LEDs. Clear lens.

Consumption: 0.33A at 12V/24V.
 Die-cast zinc body.
 Two holes for M6 fixing screws.
 With 190 mm potted lead. Type of protection: IP5K9K.

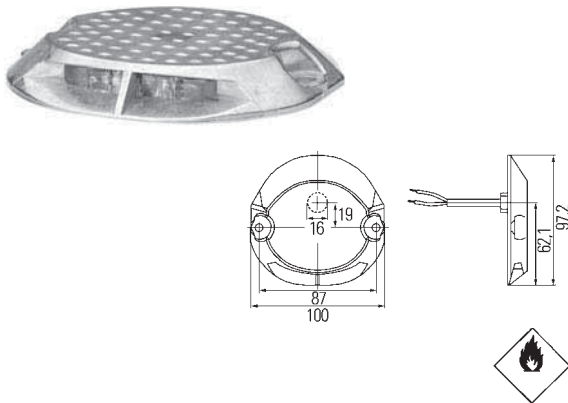

Part no.	Pk.	
2BA 009 204-041	1	Indicator light, 12V4.0W
2BA 009 204-051	1	24V8.0W
2BA 009 204-057	20	

Without patented electronics for indicator failure check. Indicator failure check is not mandatory for lifting loading platforms. For rear mounting (category 2a) of liftype loading platforms. In LED-technology.

With 12 amber LEDs 2.8W. Clear lens.

Consumption: 0.24A at 12V, 0.12A at 24V.
 Die-cast zinc body. Two M6 fixing screws.
 With potted leads. Type of protection: IP5K9K.

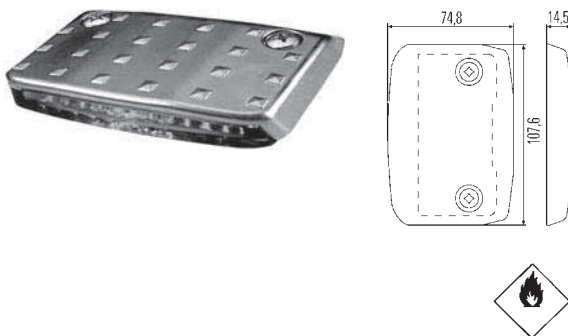

Part no.	Pk.	
2BA 008 260-017	1	Indicator light, 12V
2BA 008 260-001	1	24V
2BA 008 260-007	20	

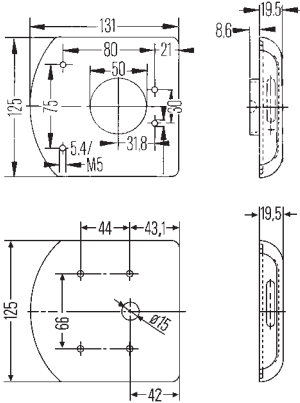

For surface mounting

For rear mounting (category 2a) of lift type loading platforms.
Amber lens.
Die-cast zinc body.

Part no.	Pk.	
2BA 007 135-001	2	Indicator light with four 5.4 mm dia. holes for fixing screws and PG9-lead retention
2BA 007 135-011	2	with heavy-duty lens and mounting bolts M5 x 35 extending all the way through
8GP 003 594-121	10	Spare parts/Accessories: W5W bulb, 12V
8GP 003 594-251	10	24V
4AZ 003 787-021	1	Also required for installation: Flasher unit, 24V

2

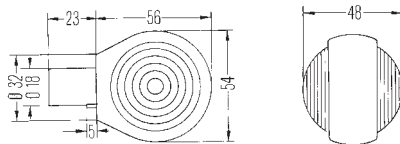

Handlebar indicator lights for two-wheeled vehicles

Amber lens.
Frame polished. Fixed with clamping screw with 17.8 mm dia. pin.
National type test for Germany.

Part no.	Pk.	
2BA 001 236-001	1	Indicator light
9EL 085 408-001	10	Spare parts/Accessories: Lens
8GM 002 091-121	10	K bulb, 12V18W

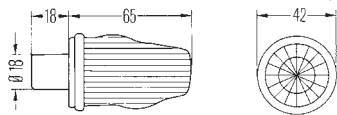

Amber lens.
With 17.8 mm dia. fixing fitting.
National type test for Germany.

Part no.	Pk.	
2BA 001 263-001	4	Indicator light
8GM 002 091-121	10	Accessories: K bulb, 12V18W

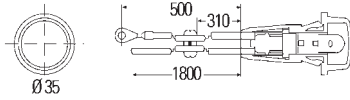

For flush mounting

For side flush mounting (category 5).
Amber lens.

Part no.	Pk.	
2BM 003 563-111	1	Auxiliary indicator with lead
8GP 003 594-121	10	Spare parts: W5W bulb, 12V

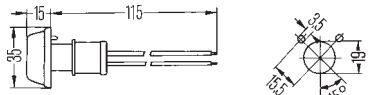

For side flush mounting (category 5).
Contents: two indicators with amber lenses and 12V bulbs.

Part no.	Pk.	
2BM 009 320-807	1	Auxiliary indicator set
8GP 002 067-121	10	Spare parts: T4W bulb, 12V

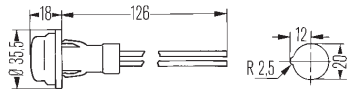

For side flush mounting (category 5).
Contents: two indicators with amber lenses and 12V bulbs.

Part no.	Pk.	
2BM 004 965-801	1	Auxiliary indicator set
8GP 003 594-121	10	Spare parts: W5W bulb, 12V

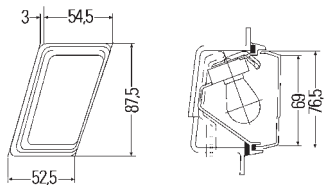

For side flush mounting (category 5).
Amber lens.

Part no.	Pk.	
2BM 004 312-051	1	Auxiliary indicator, left
2BM 004 312-061	1	right
8GA 002 073-121	10	Accessories: P21W bulb, 12V
8GA 002 073-241	10	24V

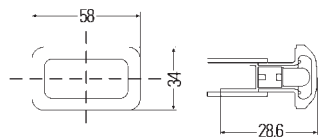

For side flush mounting (category 5).
Amber lens.

Part no.	Pk.	
2BM 003 647-021	1	Auxiliary indicator without bulb
2BM 003 647-067	288	with 12V bulb
8GP 003 594-121	10	Spare parts/Accessories: W5W bulb, 12V

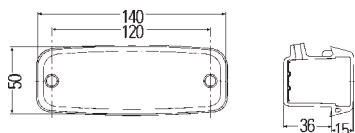

For surface mounting

For side mounting (category 5).
Amber lens, with lead.

Part no.	Pk.	
2BM 002 847-011	1	Auxiliary indicator, left
2BM 002 847-021	1	right
9EL 115 830-001	5	Spare parts/Accessories: Lens
8GA 002 073-121	10	P21W bulb, 12V

For surface mounting

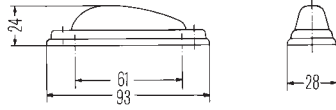

For side mounting (category 5).

Amber lens,

Chrome-plated rim, two M3 fixing screws.

Part no.	Pk.	
2BM 001 318-001	5	Auxiliary indicator
8GP 002 067-121	10	Accessories: T4W bulb, 12V

For side mounting (category 5).

Amber lens.

Two B2.9 fixing screws.

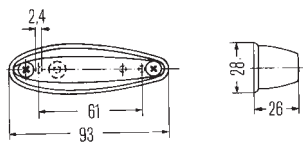

Part no.	Pk.	
2BM 001 313-001	2	Auxiliary indicator

Contents:
two indicators with amber lenses
and 12V bulbs.

2BM 001 313-821	1	Auxiliary indicator set Pro-fit pack
-----------------	---	---

Spare parts/Accessories optional:

8GP 002 067-121	10	T4W bulb, 12V
8GP 002 068-121	10	T8/2 bulb, 12V

For flush mounting

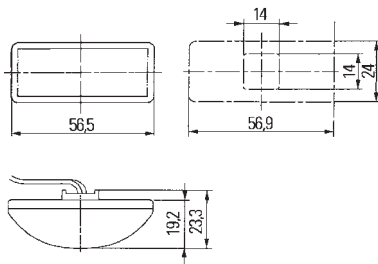

For side mounting (category 6).

Also suitable for installation in the external mirror.

In LED-technology. Clear lens.

With 3 amber LEDs and 800 mm long lead.

Consumption: 0.06A at 12V.

Black body. See LED instruction 2.

Part no.	Pk.	
2BM 008 771-001	1	Auxiliary indicator, 12V0.7W
2BM 008 771-007	30	
9GD 159 820-007	100	Accessories: Adhesive tape, white

For surface mounting

In LED-technology. Clear lens.
With 5 amber LEDs.

Consumption: 0.4A at 12V, 0.15A at 24V.
See LED instruction 2.

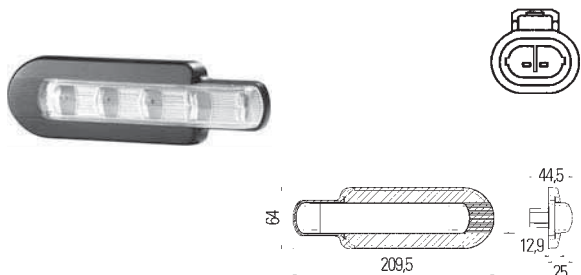

Part no.	Pk.	
		With 2-pole AMP-Superseal plug connector. Black plastic frame. Three 4.6 mm dia. holes for fixing screws.
2BM 011 788-011	1	Auxiliary indicator, 12V4.8W
2BM 011 788-001	1	Auxiliary indicator, 24V3.5W
2BM 011 788-007	50	
		With 500 mm long lead. Black plastic frame. Three 4.6 mm dia. holes for fixing screws.
2BM 011 788-031	1	Auxiliary indicator, 12V4.8W
2BM 011 788-021	1	Auxiliary indicator, 24V3.5W
2BM 011 788-027	50	
9AB 194 559-001	1	Spare parts: Plastic frame
		With 2-pole AMP-Superseal plug connector and adhesive tape.
2BM 011 788-051	1	Auxiliary indicator, 12V4.8W
2BM 011 788-057	50	
2BM 011 788-041	1	Auxiliary indicator, 24V3.5W
2BM 011 788-047	50	
		With 500 mm long lead and adhesive tape.
2BM 011 788-071	1	Auxiliary indicator, 12V4.8W
2BM 011 788-077	50	
2BM 011 788-061	1	Auxiliary indicator, 24V3.5W

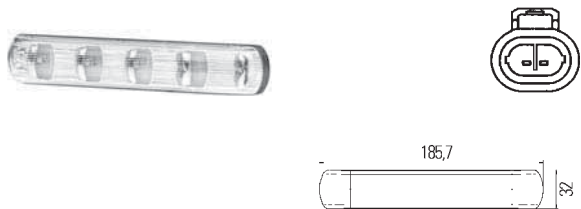

For busses. For side mounting (category 6).

Black body. Three 3.5 x 35 mm fixing screws.
For use in splashwater-protected area.

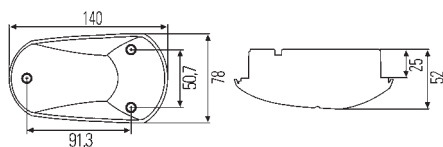

Part no.	Pk.	
		Amber lens.
2BM 008 355-001	1	Auxiliary indicator
2BM 008 355-007	30	
8GA 002 073-241	10	Accessories: P21W bulb, 24V
		Clear lens.
2BM 008 355-017	30	Auxiliary indicator
8KA 157 425-007	1	Accessories: Lead set, 2-conductor for non-splashwater-protected area, 1200 mm long with two 6.3 mm blade terminals
8GA 006 841-241	10	PY21W bulb, 24V

For surface mounting

**For side mounting (category 5 and 6).
Amber lens.**

Two B4.2 x 19 fixing screws.

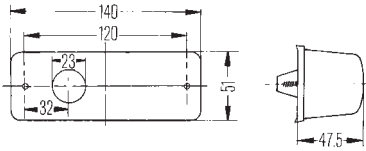

Part no.	Pk.	
2BM 006 692-011	1	Auxiliary indicator, left
2BM 006 692-017	18	
2BM 006 692-021	1	right
2BM 006 692-027	18	
Accessories:		
8GA 002 073-121	10	P21W bulb, 12V
8GA 002 073-241	10	24V

For flush mounting

Clear lens.

Three dia. holes for fixing screws.
With 3-pole Junior Power Timer plug connector.

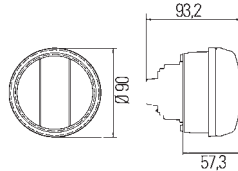

Part no.	Pk.	
		Indicator light with bulb. Position light in LED-technology. Consumption: 0.03A at 12V, 0.04A at 24V.
2BE 010 102-001	1	Indicator-position light with silver coloured 12V bulb and 2 white LEDs 0.4W
9AH 165 968-001	1	Bracket
8JD 162 581-802	1	Plug set
		Indicator light with bulb. Position light in LED-technology. Consumption: 0.04A at 24V.
2BE 010 102-011	1	Indicator-position light with amber 24V bulb and 2 white LEDs 0.85W
9AH 165 968-001	1	Bracket
8JD 162 581-802	1	Plug set
8GA 006 841-241	10	PY21W bulb, 24V
		Daytime running light in bulb-technology. Position light in LED-technology. Consumption: 0.03A at 12V, 0.04A at 24V.
2BE 010 102-101	1	Position and daytime running light with white 12V bulb and 2 white LEDs 0.4W
2PT 010 102-111	1	Daytime running light with position light with white 24V HD bulb and 2 white LEDs 0.85W
9AH 165 968-001	1	Bracket
8JD 162 581-802	1	Plug set
8GA 002 073-271	10	P21W bulb, 12V (LL)
8GA 002 073-251	10	24V (HD)

In LED-technology. Clear lens.

With 25 LEDs and 2500 mm long lead.

Indicator light: 4.0W, position light: 1.0W, daytime running light: 4.0W.

Consumption at 12V:

indicator light: 0,33A, position light: 0,08A, daytime running light: 0,33A.

Consumption at 24V:

indicator light: 0,17A, position light: 0,04A, daytime running light: 0,17A.

Black plastic body.

One fixing screw 6,3 mm.

Type of protection: IP6K6 and IP6K7.

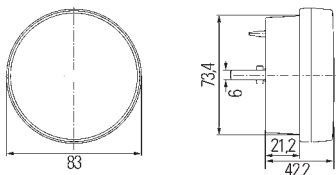

Part no.	Pk.	
2BE 980 691-101	1	Indicator-position-daytime running light, 12V
2BE 980 690-101	1	24V
2BE 980 691-001	1	with daytime running light switch off at indicator light, 12V
2BE 980 690-001	1	with daytime running light switch off at indicator light, 24V
9GD 980 696-001	1	Adapter rim

For surface mounting

Amber indicator light, white position light.

Die-cast body with black rubber base.
Two M5 fixing screws.
For Massey-Ferguson.
National type test for Germany.



Part no.	Pk.	
2BE 001 278-011	1	Indicator-position light, left
2BE 001 278-021	1	right
Spare parts:		
9EL 087 769-001	1	Lens
9FT 087 771-001	5	Bulb holder
8GM 002 094-121	10	M bulb, 12V
8GM 002 091-121	10	K bulb, 12V

Amber indicator light, white position light.

Two 4.5 mm dia. holes for fixing screws.
For Claas, John Deere, Deutz-Fahr, Fendt.

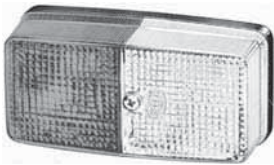

Part no.	Pk.	
2BE 003 347-001	1	Indicator-position light
Spare parts:		
9EL 120 224-001	5	Body with screw
		P21W bulb,
8GA 002 073-121	10	12V
8GA 002 073-241	10	24V
		C5W bulb,
8GM 002 092-121	10	12V
8GM 002 092-241	10	24V

For flush mounting

Clear lens.

Lamp fastened with catch at side.

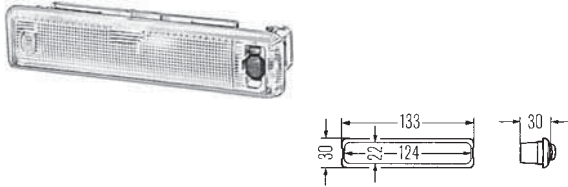

Part no.	Pk.	
2JA 001 357-002	6	Interior light with switch
2JA 001 357-012	6	without switch
Accessories:		
8GM 002 091-131	10	K bulb, 12V
8GM 002 091-251	10	24V

Clear lens.

With rotary switch and 12V bulb.

Clamp fixing.

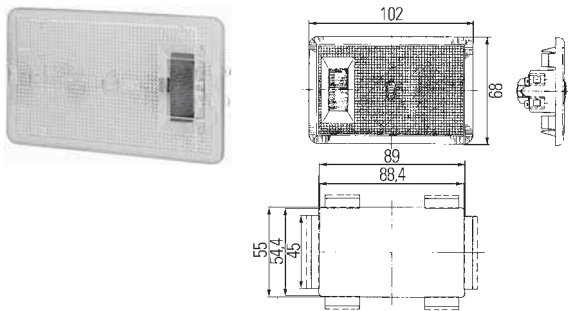

Part no.	Pk.	
2JA 002 811-027	1	Interior light
Spare parts:		
8GM 002 091-131	10	K bulb, 12V

Frosted white lens. With switch.

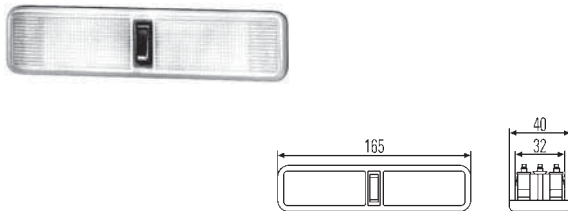

Part no.	Pk.	
2JA 996 038-001	1	Interior light
Accessories:		
8GM 002 091-131	10	K bulb, 12V
8GM 002 091-251	10	24V

Clear lens.

With switch and ON/OFF door contact.

Two 7 mm dia. holes for fixing screws.

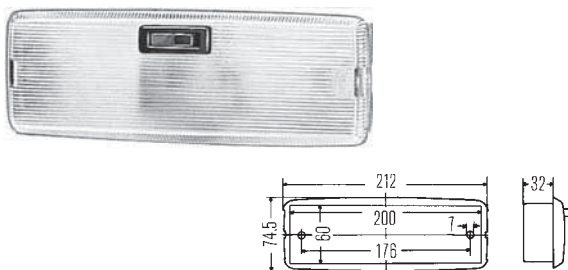

Part no.	Pk.	
2JA 002 661-001	1	Interior light
Spare parts/Accessories:		
9EL 116 607-005	1	Lens
8GA 002 073-121	10	P21W bulb, 12V
8GA 002 073-241	10	24V

In LED-technology. Clear lens.

With 10 LEDs 1.7W and 2500 mm long lead.

Consumption: 0.17A at 12V, 0.09A at 24V.

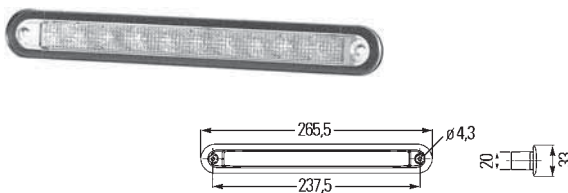

Part no.	Pk.	
2JA 959 073-001	1	Interior light, 12V
2JA 959 073-201	1	24V

For flush mounting

Clear lens.

Grey body (-041/-251), black body (-087).

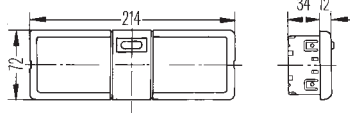
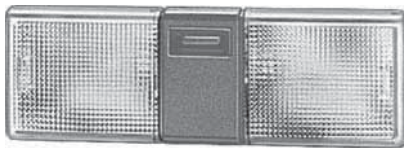
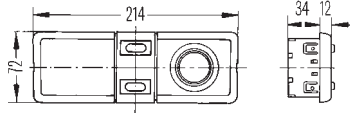
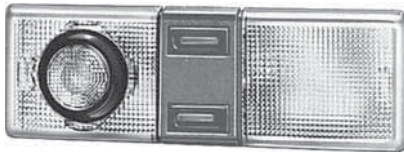

Part no.	Pk.	
2JA 006 447-041	1	Interior light with adjustable spot light and switch for interior light and spot
2JA 006 447-087	30	with adjustable spot, without switch
Accessories:		
8GA 002 073-121	10	P21W bulb for interior light, 12V
8GA 002 073-241	10	24V
8GA 002 071-131	10	R10W bulb for spot light, 12V
8GA 002 071-251	10	24V
<hr/>		
2JA 006 447-251	1	Interior light without spot, with ON/OFF door contact
Accessories optional:		
8GA 002 071-131	10	R10W bulb, 12V
8GA 002 071-251	10	24V
8GA 002 073-121	10	P21W bulb, 12V
8GA 002 073-241	10	24V

Clear lens, with spot.

Switch for interior light and spot.

Grey body.

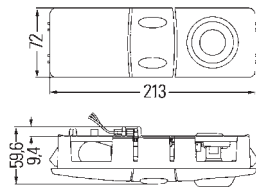

Part no.	Pk.	
2JA 009 037-017	14	Interior light with 12V bulbs
2JA 009 037-027	14	with 24V bulbs
Spare parts/Accessories:		
8GA 002 073-121	10	P21W bulb for interior light, 12V
8GA 002 073-241	10	24V
8GA 002 071-131	10	R10W bulb for spot light, 12V
8GA 002 071-251	10	24V

Clear lens. With switch and ON/OFF door contact.

Grey body.

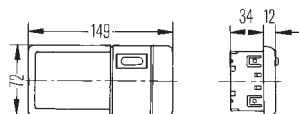
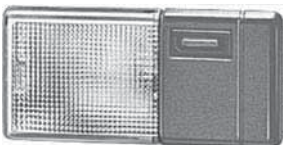

Part no.	Pk.	
2JA 006 487-261	1	Interior light without bulb
2JA 006 487-347	56	with 12V bulb
Spare parts/Accessories optional:		
8GA 002 071-131	10	R10W bulb, 12V
8GA 002 071-251	10	24V
8GA 002 073-121	10	P21W bulb, 12V
8GA 002 073-241	10	24V

For flush mounting

Clear lens. With economy circuit. It is only permissible for one bulb to be connected.

Grey rubber body. Two BZ4.2 fixing screws.

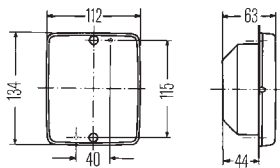

Part no.	Pk.	
2JA 003 236-357	1	Interior light
		Accessories:
		T4W bulb,
8GP 002 067-121	10	12V
8GP 002 067-241	10	24V

Clear lens. With ON/OFF switch, door contact, 12V bulb and 150 mm long lead with 4-pole plug connector.

Plastic body.

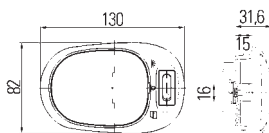

Part no.	Pk.	
2JA 964 916-001	1	Interior light with grey switch and transparent body
2JA 964 916-011	1	with black switch and black body
		Accessories:
8GM 002 091-131	10	K bulb, 12V

SpotLED

In LED-technology. Clear lens.

With 1 white Luxeon Power LED and 200 mm long lead.

With fixed spot.

Black body. Fixing with screws. Voltage range: 9V - 31V.

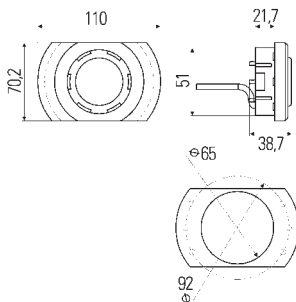

Part no.	Pk.	
		Spot: 12V/24V2.5W.
		Consumption: 0.21A at 12V, 0.10A at 24V.
		Celis ring light: 12V0.5W, 24V1.0W.
		Consumption: 0.04A at 12V, 0.02A at 24V.
2JA 343 680-177	30	Interior light with blue Celis ring light and black installation frame
2JA 343 680-127	30	Interior light with blue Celis ring light and grey installation frame
2JA 343 680-067	30	Interior light with red Celis ring light and white installation frame

For flush mounting

SpotLED

In LED-technology. Clear lens.

With 1 white Luxeon Power LED and 200 mm long lead.

With adjustable spot, 20° to each side.

Black body. Suitable with screws or spring fixing.

Voltage range: 9V - 31V.

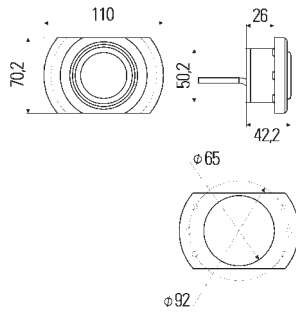

Part no.	Pk.	
2JA 343 700-051	1	<p>Spot: 12V/24V2.5W. Consumption: 0.21A at 12V, 0.10A at 24V.</p> <p>Interior light without Celis ring light, with white installation frame</p>
2JA 343 700-251	1	<p>Interior light without Celis ring light, with black installation frame</p>
2JA 343 700-221	1	<p>Spot: 12V/24V2.5W. Consumption: 0.21A at 12V, 0.10A at 24V. Celis ring light: 12V0.5W, 24V1.0W. Consumption: 0.04A at 12V, 0.02A at 24V.</p> <p>Interior light with blue Celis ring light and white installation frame</p>
2JA 343 700-271	1	<p>Interior light with blue Celis ring light and black installation frame</p>
2JA 343 700-167	30	<p>Interior light with red Celis ring light and black installation frame</p>

For flush mounting

SpotLED

In LED-technology. Clear lens.

With 1 white LED.

Spot: 12V2.5W.

Consumption: 0.20A at 12V.

Suitable with screw or spring fixing.

Electrical connection through 4-pole plug housing.

Type of protection: IP3X. Voltage range: 10V - 31V.

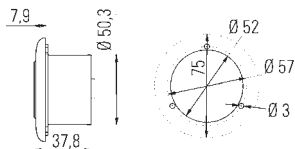

Part no.	Pk.	
2JA 344 040-701	1	Interior light with white installation frame and wide range illumination: 40°
2JA 344 040-711	1	Interior light with black installation frame and wide range illumination: 40°
2JA 344 040-721	1	Interior light with silver installation frame and wide range illumination: 40°
2JA 344 040-761	1	Interior light with silver installation frame and close range illumination: 20°
9AB 959 505-501	1	Accessories: Metal frame, round, stainless polished
9AB 959 505-561	1	stainless glaze
9AB 344 057-001	1	Plastic frame, round, black
9AB 344 057-011	1	white
9AB 344 058-001	1	Plastic frame, square, black
9AB 344 058-011	1	white
9AB 344 058-021	1	silver coloured

For flush mounting

SpotLED

In LED-technology. Clear lens.

With 1 warm tone LED with adjustable spot.

Spot: 12V/24V2.5W.

Consumption: 0.20A at 12V, 0.10V at 24V.

Celis ring light: 12V0.5W, 24V1.0W.

Consumption: 0.04A at 12V, 0.02A at 24V.

Suitable with screw or spring fixing.

Electrical connection through 4-pole plug body.

Type of protection: IP3X. Voltage range: 10V - 31V.

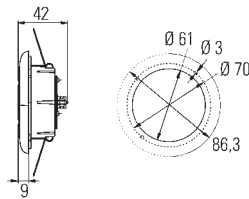

Part no.	Pk.	
2JA 343 790-301	1	Interior light with wide range illumination: 40° and white installation frame, without Celis ring light
2JA 343 790-701	1	with white Celis ring light
2JA 343 790-311	1	Interior light with wide range illumination: 40° and black installation frame, without Celis ring light
2JA 343 790-711	1	with white Celis ring light
2JA 343 790-411	1	Interior light with close range illumination: 20° and black installation frame, without Celis ring light
2JA 343 790-611	1	with white Celis ring light
2JA 343 790-341	1	Interior light with wide range illumination: 40° and silver installation frame, without Celis ring light
2JA 343 790-741	1	with white Celis ring light
2JA 343 790-441	1	Interior light with close range illumination: 20° and white installation frame, without Celis ring light
2JA 343 790-477	30	Interior light with close range illumination: 20°, silver installation frame and 200 mm long lead with AMP plug connector, without Celis ring light
9AB 343 792-061	1	Accessories: Plastic frame, round, with rounded edges, chrome plated
9AB 343 792-071	1	golden

For flush mounting

SpotLED

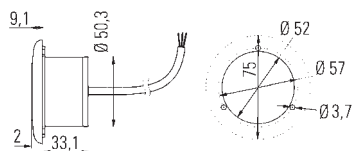

In LED-technology. Clear lens.
 With 1 warm tone LED and adjustable spot.
 Close range illumination: 20°.
 Possible to switch between white functional lighting and blue night design.
 Spot: 12V/24V2.5W.
 Consumption: 0.20A at 12V, 0.10V at 24V.
 Celis ring light: 12V0.5W, 24V1.0W.
 Consumption: 0.04A at 12V, 0.02A at 24V.
 Suitable with screw or spring fixing.
 Electrical connection through 4-pole plug body.
 Type of protection: IP3X. Voltage range: 10V - 31V.

Part no.	Pk.	
2JA 343 790-107	30	Interior light with blue Celis ring light and white installation frame

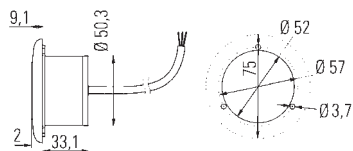

In LED-technology. Clear lens.
 With 1 warm tone LED, fixed spot and 200 mm long lead.
 Close range illumination: 20°.
 Spot: 12V/24V 2.5W.
 Consumption: 0.20A at 12V, 0.10V at 24V.
 Celis ring light: 12V0.5W, 24V1.0W.
 Consumption: 0.04A at 12V, 0.02A at 24V.
 Three 3.7 mm dia holes for fixing screws.
 Voltage range: 10V - 31V.

Part no.	Pk.	
2JA 343 980-217	48	Interior light with white Celis ring light and black installation frame

SpotBulb

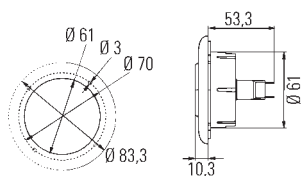

Clear lens. With 12V bulb.
 With adjustable spot. Wide range illumination: 35°.
 Electrical connection by blade receptables 6.3 mm.
 Suitable with screw or spring fixing.
 Type of protection: IP3X.

Part no.	Pk.	
2JA 343 795-011	1	Interior light with black installation frame
8GP 003 594-121	10	Spare parts: W5W bulb, 12V

For flush or surface mounting

SpotLED Set

In LED-technology. Clear lens.

Spot: 5V1.5W. Consumption: 0.30A at 5V.

Celis ring light: 5V0.5W. Consumption: 0.10A at 5V.

Electrical connection with two 500 mm long leads.

Three 3.7 mm dia. holes for fixing screws. Type of protection: IP20.

4 SpotLED lights with 1 warm white
Power-LED each, 4 attachment frames,
4 sealing rings for flush-mounting and
1 central control unit 5XA 344 150-001.

Technical data central control unit:

Voltage range: 9V - 32V. Output voltage: 3A at 5V.

Number of circuits: 2 with max. 4 SpotLEDs per circuit,
to be dimmed separately. Screw connections.

Power consumption: 1 - 16W. Type of protection: IP30.

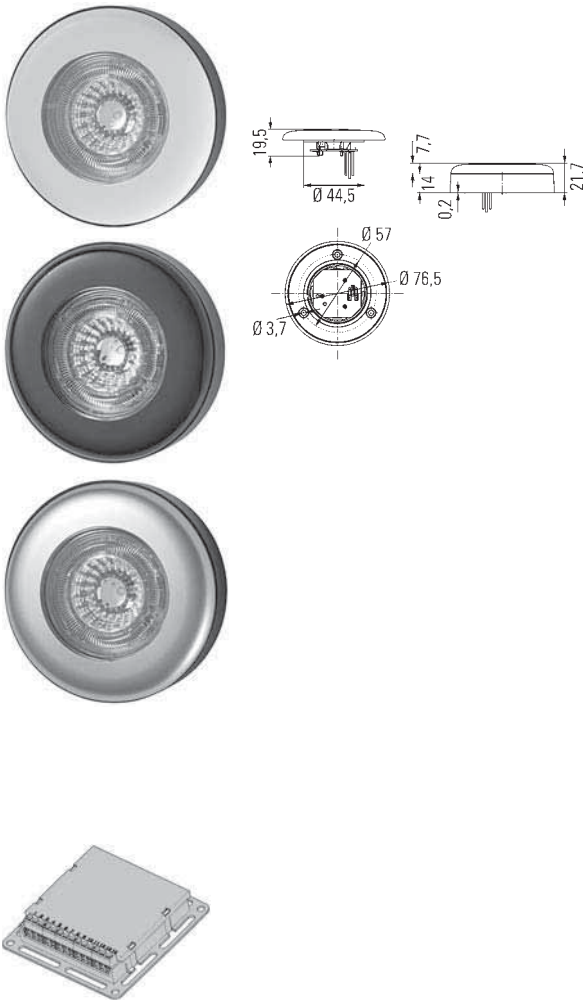

Part no.	Pk.	
2JA 344 190-301	1	Interior light set with red Celis ring light with white frame
2JA 344 190-311	1	with black frame
2JA 344 190-351	1	Interior light set with orange Celis ring light with white frame
2JA 344 190-361	1	with black frame
2JA 344 190-371	1	with silver frame
Spare parts/Accessories:		
9AB 959 505-501	1	Metal frame, round, stainless polished
9AB 959 505-561	1	stainless glaze
9AB 344 057-001	1	Plastic frame, round, with sharp edges, black
9AB 344 057-011	1	white
9AB 344 057-061	1	chrome-plated
9AB 344 057-071	1	golden
9XD 344 192-061	1	Frame for surface mounting, round, chrome-plated
9XD 344 192-071	1	golden
9AB 344 058-001	1	Plastic frame, square, with sharp edges, black
9AB 344 058-011	1	white
9AB 344 058-021	1	silver coloured
9AB 344 058-061	1	chrome-plated
9AB 344 058-071	1	golden
5XA 344 150-011	1	Central control unit for triggering a maximum of 8 SpotLEDs in a circuit with the additional option of triggering and dimming interior lights up to a maximum power consumption of 70W via the 2nd circuit

For flush or surface mounting

SpotLED

In LED-technology. Brilliant clear lens.

With 1 white Power-LED and fixed spot.

Spot: 5V1.5W. Consumption: 0.30A at 5V.

Electrical connection through 2 x 500 mm long leads.

Three 3.7 mm dia. holes for fixing screws. Type of protection: IP20.

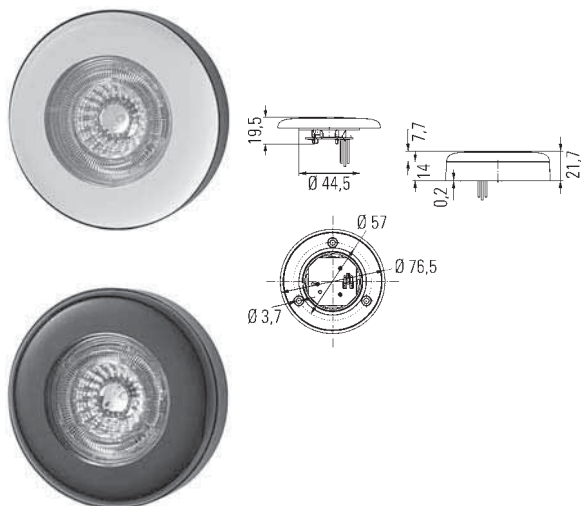

Part no.	Pk.	
2JA 344 199-001	1	Interior light without Celis ring light, with white frame
2JA 344 199-011	1	with black frame
		Accessories:
9AB 959 505-501	1	Metal frame, round, stainless polished
9AB 959 505-561	1	stainless glaze
9AB 344 057-001	1	Plastic frame, round, with sharp edges, black
9AB 344 057-011	1	white
9AB 344 057-061	1	chrome-plated
9AB 344 057-071	1	golden
9AB 344 045-061	1	Plastic frame, round, black
9AB 344 045-071	1	golden
9XD 344 192-061	1	Frame for surface mounting, round, chrome-plated
9XD 344 192-071	1	golden
9AB 344 058-001	1	Plastic frame, square, with sharp edges, black
9AB 344 058-011	1	white
9AB 344 058-021	1	silver coloured
9AB 344 058-061	1	chrome-plated
9AB 344 058-071	1	golden

For flush or surface mounting

SpotLED

In LED-technology. Brilliant-clear lens.

With 1 white Power-LED and fixed spotlight.

Spot: 5V1.5W. Consumption: 0.30A at 5V.

Celis ring light: 5V0.5W. Consumption: 0.10A at 5V.

Electrical connection through 2 x 500 mm long leads.

Three 3.7 mm dia. holes for fixing screws. Type of protection: IP20.

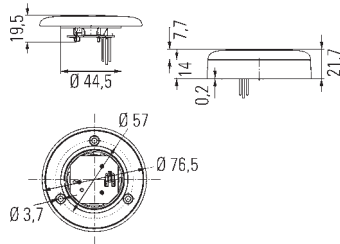

Part no.	Pk.	
2JA 344 199-121	1	Interior light with warm tone Celis ring light with silver frame
2JA 344 199-201	1	Interior light with blue Celis ring light with white frame
2JA 344 199-211	1	with black frame
2JA 344 199-221	1	and silver frame
2JA 344 199-301	1	Interior light with red Celis ring light and white frame
2JA 344 199-311	1	and black frame
2JA 344 199-351	1	Interior light with orange Celis ring light and white frame
2JA 344 199-371	1	and silver frame
9AB 959 505-501	1	Accessories: Metal frame, round, stainless polished
9AB 959 505-561	1	stainless glaze
9AB 344 057-001	1	Plastic frame, round, with sharp edges, black
9AB 344 057-011	1	white
9AB 344 057-061	1	chrome-plated
9AB 344 057-071	1	golden
9AB 344 045-061	1	Plastic frame, round, black
9AB 344 045-071	1	golden
9XD 344 192-061	1	Frame for surface mounting, round, chrome-plated
9XD 344 192-071	1	golden
9AB 344 058-001	1	Plastic frame, square, with sharp edges, black
9AB 344 058-011	1	white
9AB 344 058-021	1	silver coloured
9AB 344 058-061	1	chrome-plated
9AB 344 058-071	1	golden

For flush or surface mounting

HighPower SpotLED Set

In LED-technology. Clear lens.

Spot: 5V2.6W. Consumption: 0.50A at 5V.

Celis ring light: 5V0.5W. Consumption: 0.10A at 5V.

Electrical connection with 500 mm long leads.

Three 3.5 mm dia. holes for fixing screws. Type of protection: IP20.

Contents:

4 SpotLED lights with 1 warm white Power-LED each,
4 attachment frames, 4 sealing rings for flush-mounting and
1 central control unit 5XA 344 150-001.

Technical data central control unit:

Voltage range: 9V - 32V. Output voltage: 3A at 5V.

Number of circuits: 2 with max. 4 SpotLEDs per circuit,
to be dimmed separately. Screw connections.

Power consumption: 1 - 16W. Type of protection: IP30.

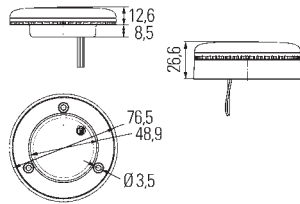

Part no.	Pk.	
2JA 344 590-001	1	Interior light set without Celis ring light, with white frame
2JA 344 590-011	1	with black frame
2JA 344 590-021	1	with silver frame
2JA 344 590-101	1	Interior light set with warm tone Celis ring light and white frame
2JA 344 590-111	1	and black frame
2JA 344 590-121	1	and silver frame
		Spare parts/Accessories:
9AB 959 505-501	1	Metal frame, round, stainless polished
9AB 959 505-561	1	stainless glaze
9AB 344 057-001	1	Plastic frame, round, with sharp edges, black
9AB 344 057-011	1	white
9AB 344 057-061	1	chrome-plated
9AB 344 057-071	1	golden
9AB 344 045-061	1	Plastic frame, round, with rounded edges, black
9AB 344 045-071	1	golden
9XD 344 192-061	1	Frame for surface mounting, round, chrome-plated
9XD 344 192-071	1	golden
9AB 344 058-001	1	Plastic frame, square, with sharp edges, black
9AB 344 058-011	1	white
9AB 344 058-021	1	silver coloured
9AB 344 058-061	1	chrome-plated
9AB 344 058-071	1	golden
5XA 344 150-011	1	Central control unit for triggering a maximum of 8 SpotLEDs in a circuit with the additional option of triggering and dimming interior lights up to a maximum power consumption of 70W via the 2nd circuit

For flush or surface mounting

HighPower SpotLED

In LED-technology. Clear lens.

With 1 white Power-LED and fixed spotlight, two frames and seal.

Spot: 5V2.6W. Consumption: 0.50A at 5V.

Celis ring light: 5V0.5W. Consumption: 0.10A at 5V.

Electrical connection with 500 mm long leads.

Three 3.5 mm dia. holes for fixing screws. Type of protection: IP20.

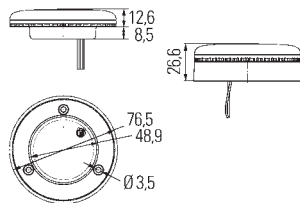

Part no.	Pk.	
		Interior light without Celis ring light, with white frame
2JA 344 599-001	1	
2JA 344 599-011	1	with black frame
2JA 344 599-021	1	with silver frame
		Interior light with warm tone Celis ring light and white frame
2JA 344 599-101	1	
2JA 344 599-111	1	and black frame
2JA 344 599-121	1	and silver frame
		Interior light with blue Celis ring light and white frame
2JA 344 599-201	1	
2JA 344 599-211	1	and black frame
2JA 344 599-221	1	and silver frame
		Interior light with red Celis ring light and white frame
2JA 344 599-301	1	
2JA 344 599-311	1	and black frame
2JA 344 599-321	1	and silver frame
		Interior light with orange Celis ring light and white frame
2JA 344 599-351	1	
2JA 344 599-361	1	and black frame
2JA 344 599-371	1	and silver frame
		Accessories:
9AB 959 505-501	1	Metal frame, round, stainless polished
9AB 959 505-561	1	stainless glaze
9AB 344 057-001	1	Plastic frame, round, with sharp edges, black
9AB 344 057-011	1	white
9AB 344 057-061	1	chrome-plated
9AB 344 057-071	1	golden
9AB 344 045-061	1	Plastic frame, round, with rounded edges, black
9AB 344 045-071	1	golden
9XD 344 192-061	1	Frame for surface mounting, round, chrome-plated
9XD 344 192-071	1	golden
9AB 344 058-001	1	Plastic frame, square, with sharp edges, black
9AB 344 058-011	1	white
9AB 344 058-021	1	silver coloured
9AB 344 058-061	1	chrome-plated
9AB 344 058-071	1	golden

For flush mounting

Ambient SpotLED

In LED-technology. Brilliant-clear lens.

With 1 LED 0.3W.

Consumption: 0.025A at 12V/24V

Installation with fixing ring or alternativ 2 holes for ST3.5 fixing screws.

Electrical connection with 4-pole AMP micro plug connector.

Operating temperature: -40 °C to + 60 °C. Type of protection: IP3X.

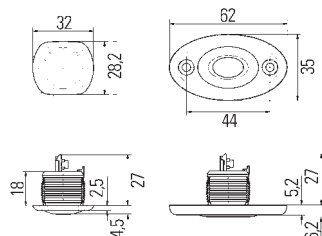

Part no.	Pk.	
2JA 344 170-021	1	Interior light with 3 frames (black, white and grey) and ambient white lighting, 12V
2JA 344 170-121	1	24V
2JA 344 170-201	1	Interior light with 3 frames (black, white and silver) and ambient white lighting, 12V

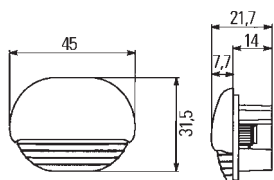

In LED-technology. Clear lens.

Consumption: 0.04A at 12V.

With white cap and 100 mm long lead.

Part no.	Pk.	
2JA 998 560-017	20	Interior light with 1 white LED, 12V0.3W
2JA 998 560-057	20	with 1 blue LED, 12V0.3W

For flush mounting

Mini OvalLED

In LED-technology. Brilliant clear lens.

Consumption: 0.05A at 12V, 0.15A at 24V.

Black body.

Electrical connection through 150 mm long lead.

Operating temperature: -40 °C to +60 °C.

Type of protection: IP6K9K, switch IP40.

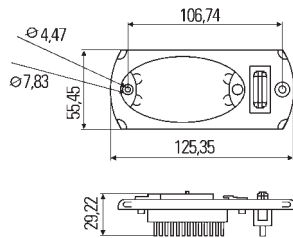
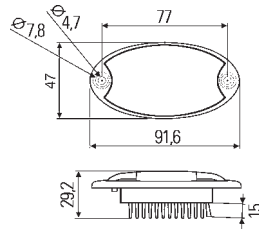

Part no.	Pk.	
2JA 343 570-011	1	Interior light without frame, without switch, 4 white Power LEDs and 1 LED for ambient red lighting, 12V
2JA 343 570-001	1	24V
2JA 343 570-101	1	Interior light without frame, without switch, with 4 white LEDs and 1 LED for ambient blue lighting, 24V
2JA 343 570-117	48	Interior light without frame, without switch, 4 white Power LEDs and 1 LED for ambient blue lighting, 12V
2JA 343 570-051	1	Interior light with frame, switch, 4 white Power LEDs and 1 LED for ambient red lighting, 12V
2JA 343 570-041	1	24V
2JA 343 570-157	48	Interior light with frame, switch, 4 white Power LEDs and 1 LED for ambient blue lighting, 12V
2JA 343 570-141	1	24V
2JA 343 570-061	1	Interior light with frame, switch, 4 white LEDs and 1 LED for ambient red lighting, 24V
2JA 343 570-267	48	Interior light with frame, switch, 5 white LEDs and 4-pole DEUTSCH plug connector, 24V

Clear lens.

Black body.

With switch, ON/OFF door contact and blade terminal contacts.

Suitable with screws or spring fixing.

Operating temperature: - 40 °C to + 60 °C. Type of protection: IP 3.

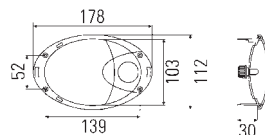

Part no.	Pk.	
2JA 009 294-001	1	Interior light with 12V bulb, without spot
2JA 009 294-021	1	with 12V bulb and spot
8GP 003 594-121	10	Spare parts: W5W bulb, 12V

For flush mounting

CargoLED

In LED-technology. Clear lens.

With 4 white LEDs, 6.0W.

Consumption: 0.5A at 12V, 0.25A at 24V.

Silver-coloured frame with four 4 mm dia. holes for fixing screws.

310 mm long connecting lead with stripped ends.

Temperature range: - 40 °C to + 60 °C.

Voltage range: 9V - 31V. Type of protection: IP6K9K.

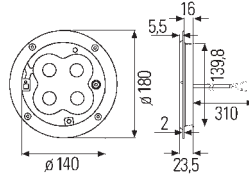

Part no.	Pk.	
2JB 343 227-041	1	Interior light with warm white light
9XD 344 118-101	1	Accessories: Grey mounting frame

In LED-technology. Clear lens.

With 12 LEDs 12V1.8W.

Consumption: 0.15A at 12V.

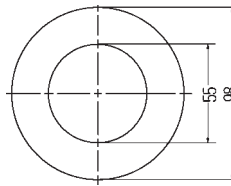

Part no.	Pk.	
2PF 008 405-061	1	Interior light with white LEDs
2JA 008 405-081	1	with blue LEDs

With halogen bulb 12V10.0W and 300 mm long connecting lead.

White body with silver-coloured rim.

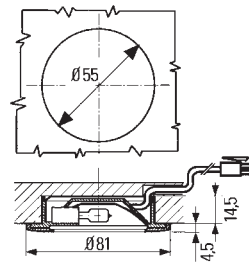

Part no.	Pk.	
2JA 009 208-001	1	Interior light with frosted white lens
2JA 009 208-011	1	with clear lens

Caution: High temperatures.

Please use silicon leads. The lamp must not come into contact with easily inflammable insulating material!

Clear PC lens.

Steel body and reflector.

Four 4 mm dia. holes for fixing screws.

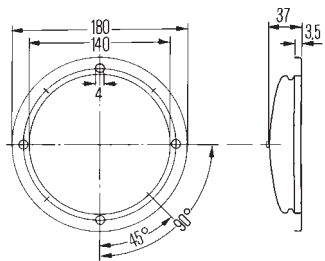

Part no.	Pk.	
2JA 008 615-001	1	Interior light
8GA 002 073-241	10	Accessories: P21W bulb, 24V

For flush mounting

**Clear lens, white base plate.
With economy circuit.**

Four holes for M4 fixing screws.
2 x 10W (full power) or 1 x 4W/ 1 x 5W
(economy circuit) bulbs as required.

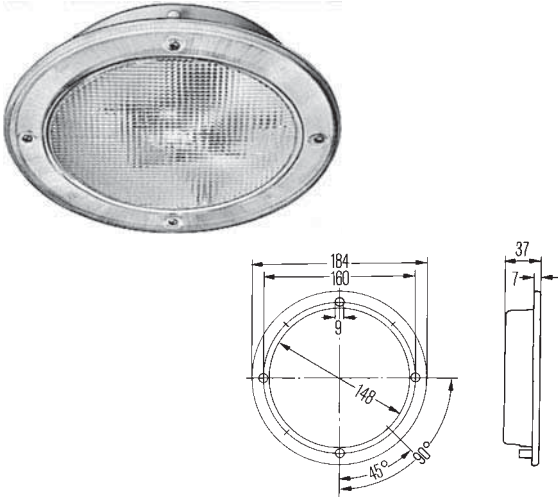

Part no.	Pk.	
2JA 005 590-001	1	Interior light with round frame
Accessories:		
8GA 002 071-131	10	R10W bulb, 12V
8GA 002 071-251	10	24V
8GP 002 067-121	10	T4W bulb, 12V
8GP 002 067-241	10	24V
8GH 002 473-151	10	Halogen bulb if required H10W, 12V

Mini ThinLED

In LED-technology. Clear lens.

Consumption (-10/-11/-40): 0.06A at 12V, 0.10A at 24V.
Consumption (-02): 0.04A at 12V.
Grey base. Two holes for M3 fixing screws.

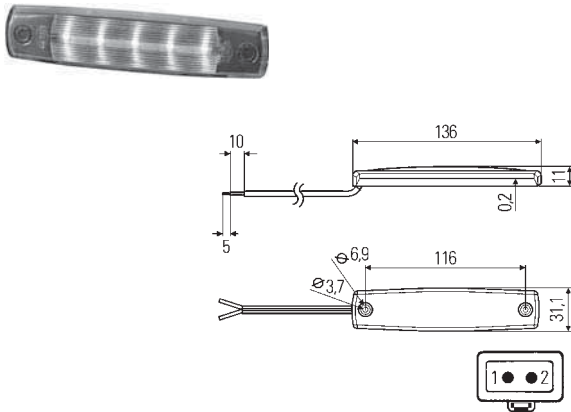

Part no.	Pk.	
2JA 343 660-101	1	Interior light with 5 white LEDs and 170 mm long lead, 12V0.7W
2JA 343 660-107	30	
2JA 343 660-117	30	24V2.3W
2JA 343 660-407	30	Interior light with 5 white LEDs, 50 mm long lead and 2-pole DEUTSCH plug connector, 24V2.3W
2JA 343 660-021	1	Interior light with 3 blue LEDs and 170 mm long lead, 12V0.42W

In LED-technology. Clear lens.

Consumption: 0.15A at 12V/24V.
Grey base. With 1000 mm long lead.

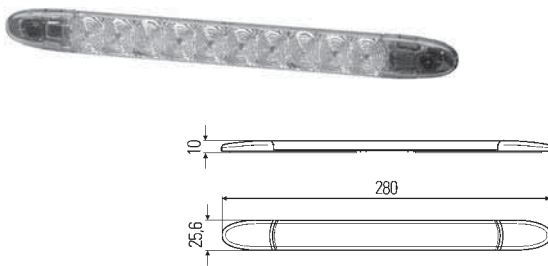

Part no.	Pk.	
2JA 343 606-001	1	Interior light with 10 white LEDs, 12V1.8W
2JA 343 606-007	30	
2JA 343 606-011	1	with 10 white LEDs, 24V3.6W
2JA 343 606-017	30	
2JA 343 606-201	1	with 10 blue LEDs, 12V1.8W
2JA 343 606-217	30	with 10 blue LEDs, 24V3.6W

For surface mounting

In LED-technology. With 2500 mm long lead and polarity reversal protection.
Clear lens.

Consumption: 0.25A at 12V, 0.125A at 24V.
2 fixing screws with screw caps.
Type of protection: IP6K6 and IP6K7.

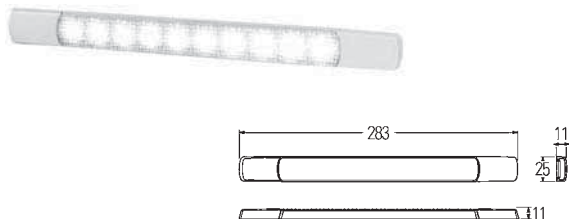

Part no.	Pk.	
2JA 980 879-011	1	Interior light with 10 white LEDs, 12V3.0W
2JA 980 879-111	1	with 10 white LEDs, 24V3.0W
2JA 980 879-201	1	with 10 warm white LEDs, 12V3.0W
2JA 980 879-301	1	with 10 warm white LEDs, 24V3.0W
Accessories:		
8HG 958 000-011	1	Plastic mounting panel for sidewall or ceiling mounting, white
8HG 958 000-021	1	black

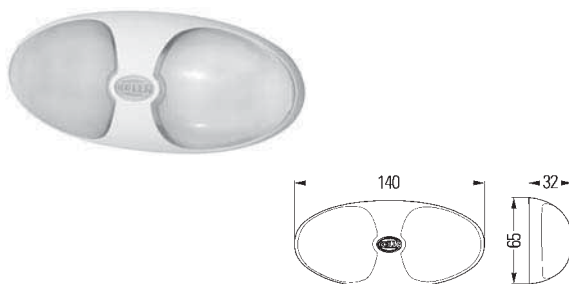

DuraLED Oval

In LED-technology. White lens.
With 180 mm long connecting lead.

Consumption: 0.26A at 12V, 0.13A at 24V.
Frame white. Two 5.0 mm dia. holes for fixing screws.
Type of protection: IP6K7K.

Part no.	Pk.	
2JA 959 700-102	1	Interior light with 12 white LEDs 12V/24V3.0W

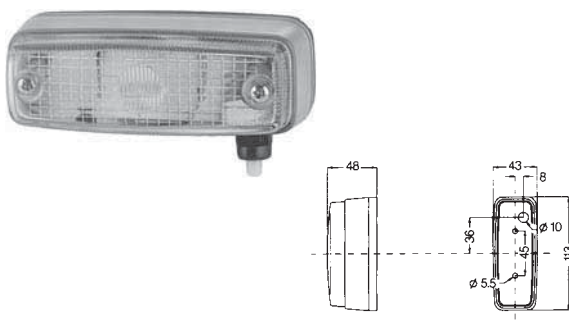

Clear lens, with switch.

Chrome-plated body, plastic base plate.

Part no.	Pk.	
2JA 997 027-051	1	Interior light
Accessories:		
8GM 002 091-121	10	K bulb, 12V
8GM 002 091-241	10	24V

For surface mounting

Frosted white lens.

Two 5 mm dia. holes for fixing screws.

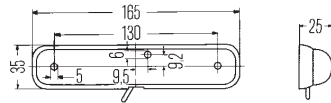

Part no.	Pk.	
2JA 001 330-001	2	Interior light with switch
2JA 001 330-007	102	
2JA 001 330-031	2	without switch
Accessories:		
8GM 002 092-121	10	C5W bulb, 12V
8GM 002 092-241	10	24V

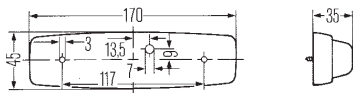
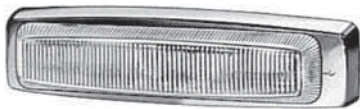

Clear lens, with switch.

Switched on and off by sliding the lens. Chrome-plated rim. Two holes for B4.2 x 13 fixing screws.

Part no.	Pk.	
2JA 001 364-001	2	Interior light
Accessories:		
8GM 002 091-131	10	K bulb, 12V
8GM 002 091-251	10	24V

Clear lens, with switch.

Black shutter adjusts light aperture. Light is switched off mechanically when shutter angle is 45°. Two 5.5 mm dia. holes for fixing screws.

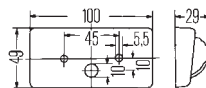
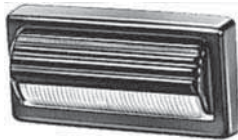

Part no.	Pk.	
2JA 004 192-001	1	Interior light
Accessories:		
8GM 002 091-131	10	K bulb, 12V
8GM 002 091-251	10	24V

In LED-technology. Clear lens.

With 4 white LEDs 24V 1.5W and 1300 mm long lead.

Wide range illumination: 40°.

Consumption: 0.06A at 24V. Black plastic body. Two 5.5 mm dia. holes for fixing screws. Type of protection: IP6K9K.

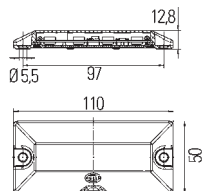

Part no.	Pk.	
2JA 010 838-017	20	Interior light

For surface mounting

In LED-technology. Clear lens.
With 8 white LEDs 3.3W.
Illumination: 65°. Colour temperature 5700° Kelvin.
 Consumption: 0.27A at 12V, 0.13A at 24V.
 Four 5.0 mm dia. holes for fixing screws.
 Voltage range: 10V - 30V.
 Type of protection -001: IP54, -011: IP67.

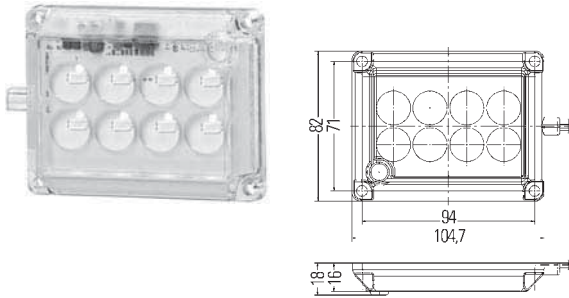

Part no.	Pk.	
2JA 012 557-001	1	Interior light with movement detector and 3100 mm long lead
2JA 012 557-007	16	
2JA 012 557-011	1	without movement detector, with 2400 mm long lead
2JA 012 557-017	16	

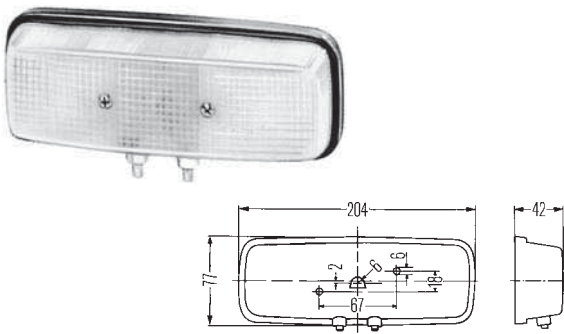

Frosted white lens.
With 2 switches. Economy circuit,
for switching on 1, 2 or 3 bulbs, as required.
 Black body. Two 6 mm dia. holes for fixing screws.

Part no.	Pk.	
2JA 001 360-001	1	Interior light
		Accessories:
8GM 002 091-131	10	K bulb, 12V
8GM 002 091-251	10	24V

Clear lens,
 two 6 mm dia. holes for fixing screws.

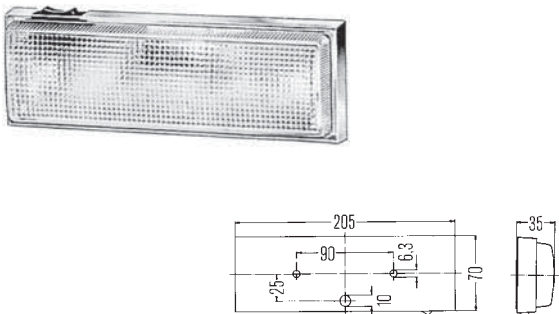

Part no.	Pk.	
2JA 003 354-001	1	Interior light with clear rim and switch
		Spare parts/Accessories:
9EL 120 240-011	2	Lens
9AR 120 266-001	4	Frame
8GM 002 091-131	10	K bulb, 12V
8GM 002 091-251	10	24V
2JA 003 354-051	1	Interior light with clear rim, without switch
		Accessories:
8GM 002 091-131	10	K bulb, 12V
8GM 002 091-251	10	24V
2JA 003 354-031	1	Interior light with chrome-plated rim and switch
		Accessories:
8GM 002 091-131	10	12V
8GM 002 091-251	10	24V

For surface mounting

Clear lens, without switch.

Black plastic body.
Two M6 x 12 fixing screws.

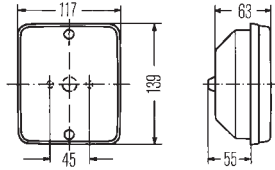

Part no.	Pk.	
2ZR 003 236-051	1	Interior light
Spare parts/Accessories:		
9EL 119 544-111	4	Lens
9DX 119 545-051	2	Reflector P21W bulb,
8GA 002 073-121	10	12V
8GA 002 073-241	10	24V

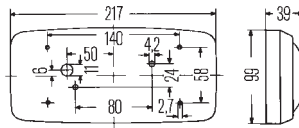

Frosted white lens, chrome-plated rim. Without switch.

Four 3.2 mm dia. holes for fixing screws.

Part no.	Pk.	
2JA 001 331-011	5	Interior light
Spare parts/Accessories:		
9EL 091 749-011	5	Lens R10W bulb,
8GA 002 071-131	10	12V
8GA 002 071-251	10	24V

Clear macrolon lens and frame. With switch.

Switched on and off by rotating the lens. 3 switch positions.
Two holes for M4 fixing screws.

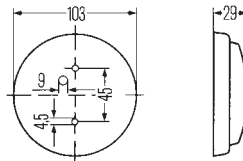

Part no.	Pk.	
2JA 003 231-001	1	Interior light with clear frame
2JA 003 231-011	1	with aluminium-anodized effect rim
Spare parts:		
8GM 002 091-131	10	K bulb, 12V
8GM 002 091-251	10	24V Bulb,
8GM 002 091-141	10	12V
8GM 002 091-261	10	24V

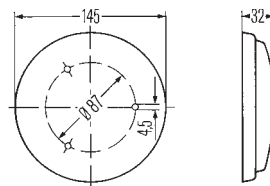

Clear macrolon lens and frame. With switch.

Switched on and off by rotating the lens. 3 switch positions.
Three holes for M4 fixing screws.

Part no.	Pk.	
2JA 003 232-001	1	Interior light with clear frame
2JA 003 232-011	1	with aluminium-anodized effect rim
Spare parts:		
8GM 002 091-131	10	K bulb, 12V
8GM 002 091-251	10	24V Bulb,
8GM 002 091-141	10	12V
8GM 002 091-261	10	24V

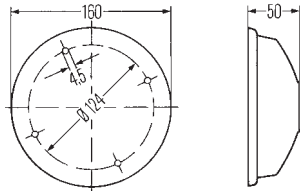

For surface mounting

Clear lens.

Chrome-type grille and rim.
Four holes for M4 fixing screws.

Part no.	Pk.	
2JA 001 335-011	1	Interior light
		Accessories:
		R5W bulb,
8GA 002 071-121	10	12V
8GA 002 071-241	10	24V
		R10W bulb,
8GA 002 071-131	10	12V
8GA 002 071-251	10	24V

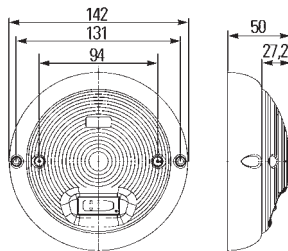

Clear lens. With switch and 12V bulb.

Black body.

Part no.	Pk.	
2JA 998 569-017	60	Interior light
		Spare parts:
8GA 002 073-121	10	P21W bulb, 12V

For flush mounting

Clear lens.

With integrated, electronic voltage transformer, switch and fluorescent tube 8.0W, soft glow. Colour temperature 3000° Kelvin, fully suppressed.

Polarity electronics.
Two 3.5 mm dia. holes for fixing screws.
Consumption: 0.7A at 12V, 0.3A at 24V.

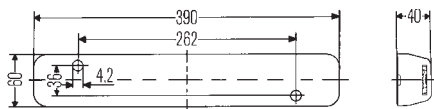
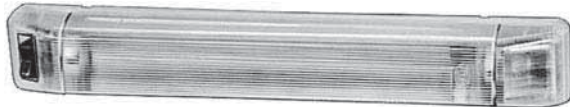

Part no.	Pk.	
2JA 004 531-001	1	Transistorized ceiling light, 12V
2JA 004 531-011	1	24V
		Spare parts/Accessories:
9EL 856 010-001	1	Lens
8GS 002 296-101	1	Fluorescent tube 8W, warm white, 2950° K
8GS 002 296-111	1	cold white, 4040° K

For horizontal surface mounting

Clear lens. With fluorescent tube 8.0W, white. Colour temperature 4040° Kelvin.

RF-suppressed = suppression class N (semi-suppressed).
White body, without switch. Consumption: 0.3A.

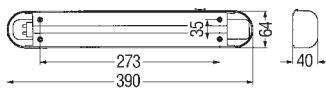

Part no.	Pk.	
2JA 340 111-001	1	Transistorised ceiling light, 24V
		Spare parts:
8GS 002 296-111	1	Fluorescent tube 8W, cold white, 4040° K

For surface mounting

In LED-technology. Clear lens.
With switch. Colour temperature 4000° Kelvin.
Illuminance

with 12 LEDs 3.5W: 100 lux at a distance of 1 m,
with 24 LEDs 4.7W: 130 lux at a distance of 1 m,
with 24 LEDs 7.0W: 200 lux at a distance of 1 m.

Consumption:

with 12 LEDs 3.5W: 0.3A at 12V, 0.15A at 24V,
 with 24 LEDs 4.7W: 0.4A at 12V, 0.2A at 24V,
 with 24 LEDs 7.0W: 0.6A at 12V, 0.3A at 24V.

Operating temperature: -40 °C to +60 °C.

With EMC test according to ECE R10. Voltage range: 10V - 31V.

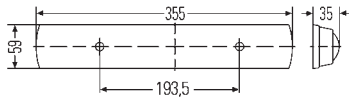

Part no.	Pk.	
2JA 007 373-151	1	Ceiling light with 12 LEDs 3.5W
2JA 007 373-157	30	
2JA 007 373-197	30	with 24 LEDs 4.7W
2JA 007 373-161	1	with 24 LEDs 7.0W

In LED-technology. With 16 LEDs 4.7W. Clear lens.
Without switch, not dimmable.
Colour temperature 4000° Kelvin.
Illuminance: 130 lux at a distance of 1 m.

Consumption: 0.4A at 12V, 0.2A at 24V.
 Operating temperature: -40 °C to +60 °C.

With EMC test according to ECE R10.

Type of protection: IP67.

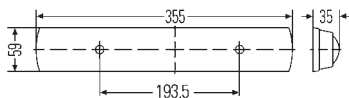

Part no.	Pk.	
2JA 007 373-187	30	Ceiling light, 12V
2JA 007 373-177	30	24V

In LED-technology. With 24 LEDs 7.0W. Clear lens.
Colour temperature 4000° Kelvin.
Illuminance: 200 lux at a distance of 1 m.

Consumption: 0.6A at 12V, 0.3A at 24V.
 Operating temperature: -40 °C to +60 °C.

With EMC test according to ECE R10.

Type of protection: IP54 (with switch), IP67 (without switch).



Part no.	Pk.	
2JA 007 373-301	1	Ceiling light with switch, 12V
2JA 007 373-307	30	
2JA 007 373-311	1	with switch, 24V
2JA 007 373-317	30	
2JA 007 373-321	1	without switch, 12V
2JA 007 373-327	30	
2JA 007 373-331	1	without switch, 24V
2JA 007 373-337	30	

For surface mounting

Clear lens.
With EMC test according to ECE R10.

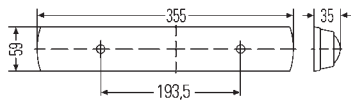
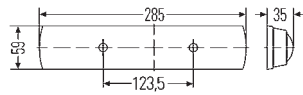
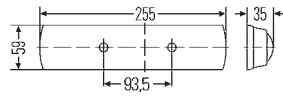

Part no.	Pk.	
2JA 007 373-001	1	Transistorised ceiling light with switch and compact 7W fluorescent tube. Colour temperature 2700° Kelvin. Consumption: 0.6A at 12V, 0.3A at 24V, 12V, fully suppressed
2JA 007 373-011	1	
8GS 861 955-001	1	Spare parts: Compact 7W fluorescent tube, white, 4000° K
2JA 007 373-031	1	Transistorised ceiling light with switch and compact 9W fluorescent tube. Colour temperature 2700° Kelvin. Consumption: 0.8A at 12V, 0.4A at 24V, 12V, fully suppressed
2JA 007 373-041	1	
8GS 861 955-011	1	Spare parts: Compact 9W fluorescent tube, white, 4000° K
2JA 007 373-061	1	Transistorised ceiling light with switch and compact 11W fluorescent tube. Colour temperature 2700° Kelvin. Consumption: 0.9A at 12V, 0.45A at 24V, 12V, fully suppressed
2JA 007 373-071	1	
8GS 861 955-021	1	Spare parts: Compact 11W fluorescent tube, white, 4000° K
2JA 007 373-117	30	Transistorised ceiling light without switch, with compact 11W fluorescent tube. Colour temperature 4000° Kelvin. Consumption: 0.9A at 12V, 0.45A at 24V, 12V, fully suppressed
2JA 007 373-107	30	
2JA 007 373-127	30	Transistorised ceiling light with switch and compact 11W fluorescent tube. Colour temperature 2700° Kelvin. Consumption: 0.9A at 12V, 12V, fully suppressed
2JA 007 373-137	30	Transistorised ceiling light without switch, with compact 11W fluorescent tube. Colour temperature 4000° Kelvin. Consumption: 0.45A at 24V, with 2x 6.3 mm blade terminals, 24V, fully suppressed
8GS 861 955-031	1	Spare parts: Compact 11W fluorescent tube, white, 2700° K

For surface mounting

Clear lens. Colour temperature 3000° Kelvin.
With EMC test according to ECE R10.

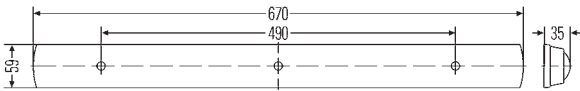
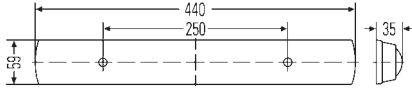

Part no.	Pk.	
2JA 007 372-001	1	Transistorised ceiling light with switch and compact 8W fluorescent tube. Consumption: 0.7A at 12V, 0.3A at 24V, 12V, fully suppressed
2JA 007 372-011	1	24V, fully suppressed
		Spare parts:
8GS 002 296-101	1	Compact fluorescent tube 8W, warm white, 2950° K
8GS 002 296-111	1	cold white, 4000° K
		Transistorised ceiling light with switch and compact 13W fluorescent tube. Consumption: 1.0A at 12V, 0.5A at 24V, 12V, fully suppressed
2JA 007 372-041	1	12V, fully suppressed
2JA 007 372-051	1	24V, fully suppressed
		Spare parts:
8GS 861 953-011	1	Compact 13W fluorescent tube, white, 3450° K

For surface mounting

Clear lens, black body.
Red lens as accessories available.

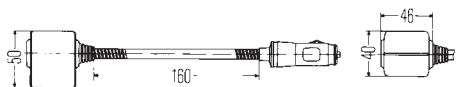
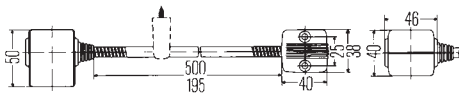

Part no.	Pk.	
2AB 004 532-001	1	Reading light with 500 mm long arm, holder and 12V5W halogen bulb
2AB 004 532-257	40	Reading light with 500 mm long arm, holder, 60 mm long lead, round plug 8KW 044 040-003 and 12V5W halogen bulb
9XB 136 202-005	1	Spare parts/Accessories: Bracket
8GH 002 473-151	10	Halogen bulb, H10W, 12V
9EL 128 922-011	10	Red lens
2AB 004 532-061	1	Reading light with 500 mm long arm, holder with 12V4W normal bulb
9XB 136 202-005	1	Spare parts/Accessories: Bracket
8GP 002 067-121	10	T4W bulb, 12V
9EL 128 922-011	10	Red lens
2AB 004 532-051	1	Reading light with 500 mm long arm, holder, and 24V7.5W Xenon bulb
2AB 004 532-057	40	
9XB 136 202-005	1	Spare parts/Accessories: Bracket
8GP 008 285-001	1	Xenon bulb, 24V
9EL 128 922-011	10	Red lens
2AB 004 532-011	1	Reading light with 195 mm long arm, holder, 100 mm long lead and 12V5W halogen bulb
8GH 002 473-151	10	Spare parts/Accessories: Halogen bulb, 12V
9EL 128 922-011	10	Red lens
2AB 004 532-031	1	Reading light with 195 mm long arm, holder, 100 mm long lead and 12V5W bulb
8GP 002 067-121	10	Spare parts/Accessories: T4W bulb, 12V
9EL 128 922-011	10	Red lens
2AB 004 532-021	1	Reading light with plug for cigarette lighter socket, 160 mm long arm and 12V5W halogen bulb
8GH 002 473-151	10	Spare parts/Accessories: Halogen bulb, 12V
9EL 128 922-011	10	Red lens
2AB 004 532-297	70	Reading light with plug for cigarette lighter socket, 160 mm long arm and 28V7.5W Xenon bulb
8GP 008 285-001	1	Spare parts/Accessories: Xenon bulb, 28V
9EL 128 922-011	10	Red lens

For surface mounting

SpotLED

In LED-technology.

With flexible arm and screw fixing.

Consumption (one LED): 0.25A at 12V, 0.13A at 24V.

Consumption (two LEDs): 0.20A at 12V, 0.10A at 24V.

Voltage range: 9V - 31V.

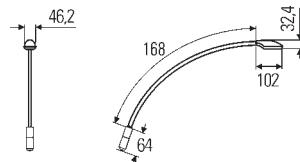
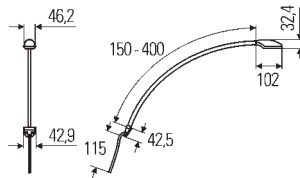

Part no.	Pk.	Description
2JA 343 720-011	1	Reading light with 1 white LED 3.0W, 115 mm long connecting lead, white cap and 150 mm long arm
2JA 343 720-021	1	black cap and 150 mm long arm
2JA 343 720-111	1	white cap and 400 mm long arm
2JA 343 720-121	1	black cap and 400 mm long arm
2JA 343 720-191	1	silver cap and 400 mm long arm
2JA 343 720-157	12	Reading light with 1 red LED 3.0W, 115 mm long lead, black cap and 400 mm long arm
2JA 343 720-511	1	Reading light with 1 white and 1 red LED 2.4W, dimmable with switch, 115 mm long connecting lead, white cap and 150 mm long arm
2JA 343 720-521	1	black cap and 150 mm long arm
2JA 343 720-531	1	silver cap and 150 mm long arm
2JA 343 720-611	1	white cap and 400 mm long arm
2JA 343 720-621	1	black cap and 400 mm long arm
2JA 343 720-631	1	silver cap and 400 mm long arm
2JA 343 720-071	1	Reading light with 1 white LED 3.0W, 2-pole plug for cigarette lighter socket and power sockets, white cap and 150 mm long arm
2JA 343 720-081	1	black cap and 150 mm long arm

Reading lights Handlights

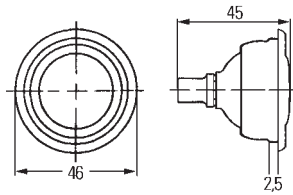

For flush mounting

Clear lens. With 12V bulb.
Black plastic body.

Part no.	Pk.	
2AB 004 074-027	1	Reading light with two 120 mm long leads
8GP 003 594-121	10	Spare parts: W5W bulb, 12V

For surface mounting

Black body and anti-glare fitment.
Switched on and off by anti-glare fitment.
Two 5.3 mm dia. holes for fixing screws.

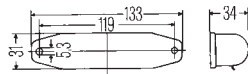
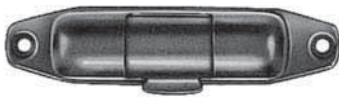

Part no.	Pk.	
2AB 001 208-001	5	Reading light
8GM 002 092-121	10	Accessories: C5W bulb, 12V
8GM 002 092-241	10	24V
8GM 002 091-131	10	K bulb, 12V
8GM 002 091-251	10	24V

Handlights

With stepless regulation from map to working, from pinpoint to wide-spread light.

Swiveling lamp head.
Fixing of the lamp with holder or magnet to the bodywork.
With spirally coiled lead (from 400 up to 3000 mm) and plug 8JA 004 667-001 (Pk. 10) for cigarette lighter socket.

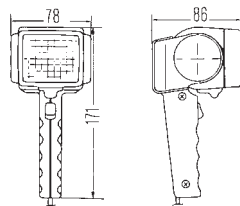

Part no.	Pk.	
2XM 004 444-001	1	Handlight with 12V6.0W Xenon bulb and plug 8JA 004 667-001 (Pk. 10)
8GP 007 676-121	10	Spare parts: Xenon bulb, 12V
8JA 004 667-001	10	Connectors
2XM 004 444-011	1	with 24V7.5W Xenon bulb and plug 8JA 007 158-001 (Pk.1)
8GP 008 285-001	1	Spare parts: Xenon bulb, 24V
8JA 007 158-001	1	Connectors

Cockpit and map reading lights for flush mounting

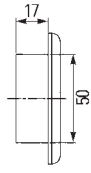
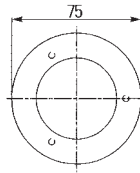

In LED-technology. Clear lens.

Consumption: 0.04A at 12V, 0.02A at 24V.

With white ring for covering the 3 fixing screws.

With 120 mm long lead, gasket and fixing screws.

Dust and water-proof, with polarity reversal protection.

Voltage range: 10V - 33V.

Part no.	Pk.	
2XT 959 500-677	1	Cockpit and map reading light with 4 white LEDs 1.0W

Orientation lights for flush mounting

In LED-technology. White lens.

With 4 white LEDs 1.0W, 120 mm long lead, gasket and fixing screws.

Consumption: 0.08A at 12V, 0.04A at 24V.

Type of protection: IP67.

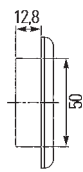
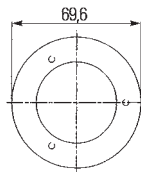

Part no.	Pk.	
2XT 980 500-227	24	Orientation light with polished stainless-steel frame, 12V
2XT 980 500-042	1	with white plastic frame, 12V
2XT 980 501-042	1	with white plastic frame, 24V



In LED-technology. White lens.

With 4 white HighPower LEDs 1.0W, 120 mm long lead, gasket and fixing screws.

Consumption: 0.08A at 12V, 0.04A at 24V.

Type of protection: IP67.

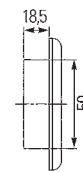
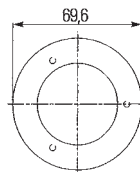

Part no.	Pk.	
2JA 959 599-002	1	Orientation light with white plastic frame, 12V
2JA 959 599-102	1	with white plastic frame, 24V

For flush mounting

In LED-technology. Clear lens.

Consumption: 0.04A at 12V, 0.02A at 24V.

With polished steel rim, 120 mm long lead, gasket and fixing screws.

Voltage range: 10V - 33V.

Type of protection: IP6K7K.

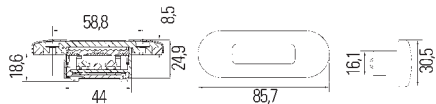

Part no.	Pk.	
2XT 959 680-812	36	Door light with 2 white LEDs 0.5W
2XT 959 680-612	36	with 2 blue LEDs 0.5W

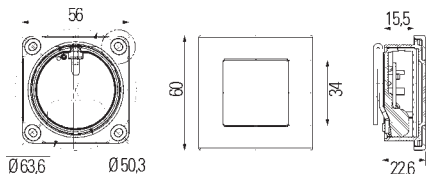

For flush mounting

In LED-technology. White lens.

Consumption: 0.08A at 12V, 0.04A at 24V.
With white plastic rim, 120 mm long lead, gasket and fixing screws.
Type of protection: IP67.

Part no.	Pk.	
2XT 980 580-052	1	Door light with 4 white LEDs 12V1.0W
2XT 980 581-052	1	with 4 white LEDs 24V1.0W
2JA 980 596-002	1	with 4 white HighPower LEDs 12V1.0W
2JA 980 596-102	1	with 4 white HighPower LEDs 24V1.0W

With 2-pole AMP plug connector and bulb.

Snap fastening.

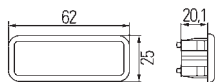

Part no.	Pk.	
2XT 009 098-001	1	Door light, 12V, with clear lens
2XT 009 098-107	250	with white lens
2XT 009 098-307	250	with red lens
8GP 003 594-121	10	Spare parts: W5W bulb, 12V
2XT 009 098-017	250	Door light, 24V, with clear lens
8GP 003 594-231	10	Spare parts: W3W bulb, 24V

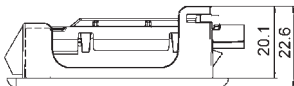
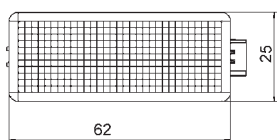

In LED-technology. With 2 LEDs 12V0.68W. White lens.

Consumption: 0.05A at 12V.
With 2-pole AMP plug connector.

Part no.	Pk.	
2XT 010 622-101	1	Illuminance: 6.2 lux at a distance of 0.4 m. Door light, 0.94 - 1.07 lm
2XT 010 622-111	1	Illuminance: 20.4 lux at a distance of 0.4 m. Door light, 4.58 - 4.92 lm

Flush mounting for curves surfaces

Frosted white lens.

Black rubber body.
2 holes for B4.2 x 16 fixing screws.

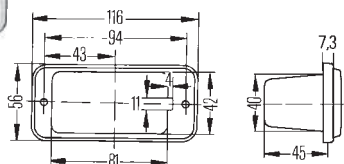
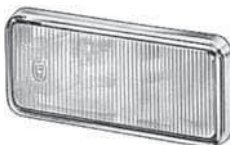

Part no.	Pk.	
2XT 002 452-037	1	Door light
8GA 002 071-121	10	Accessories: R5W bulb, 12V
8GA 002 071-241	10	24V

For caravans

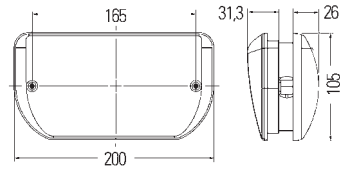
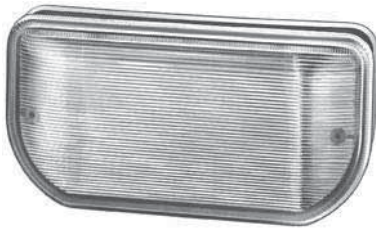

Clear lens.
With grille opening for replacing bulb.
For walls of 25 to 35 mm thickness.
 Grey plastic body and glass-clear lens,
 for screwing into one another.

Part no.	Pk.	
2XT 007 945-027	1	Door light without ON/OFF switch, with 12V bulb and lead entry right
2XT 007 945-077	30	with two pole safety switch, 12V bulb and lead entry right
8GA 002 073-121	10	Spare parts: P21W bulb, 12V

For surface mounting

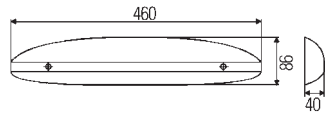

Clear lens. With 12V bulbs and gasket.
 Silver coloured body.
 Two ST3.9 x 38-C fixing screws.

Part no.	Pk.	
2XT 008 929-001	1	Door light
2XT 008 929-007	24	
8GM 002 092-121	10	Spare parts: C5W bulb, 12V

For flush mounting

For dashboards with thickness of 0.3 to 1.8 mm.
Screw-type connection.

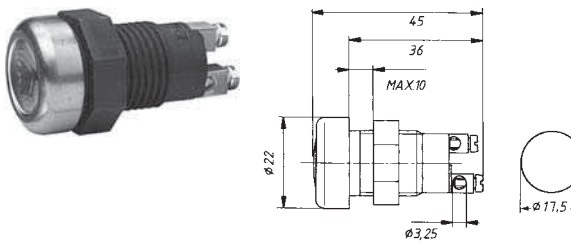
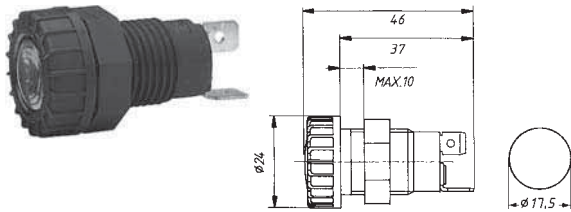
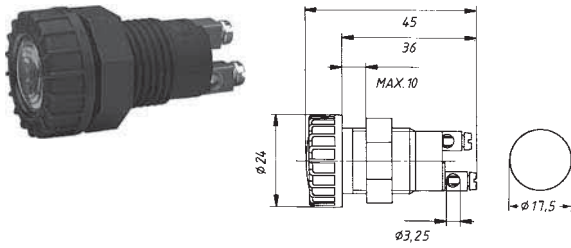

Part no.	Pk.	
2AA 008 592-021	15	Warning light with screw-type connection, green
2AA 008 592-031	15	red
		Spare parts:
8GP 002 068-121	10	H bulb, 12V
8GP 002 068-241	10	24V
2AA 008 594-001	15	Warning light with blade terminal contacts, blue
2AA 008 594-011	15	amber
2AA 008 594-021	15	green
2AA 008 594-031	15	red
		Spare parts:
8GP 002 068-121	10	H bulb, 12V
8GP 002 068-241	10	24V
2AA 008 595-021	15	Warning light with steel rim and screw-type connections, green
2AA 008 595-031	15	red
		Spare parts:
8GP 002 068-121	10	H bulb, 12V
8GP 002 068-241	10	24V

For dashboards with thickness of 0.8 to 1.5 mm.
With blade terminal contacts and clamp fixing.

Part no.	Pk.	
2AA 001 204-001	10	Warning light, red
2AA 001 204-011	10	amber
2AA 001 204-031	10	green
		Accessories:
8GP 002 066-121	10	J bulb, 12V
8GP 002 066-241	10	24V

For flush mounting

For dashboards with thickness of up to 4 mm.

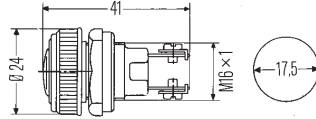

Part no.	Pk.	
2AA 001 200-001	5	Warning light with combined screw/blade terminal contacts, blue
2AA 001 200-011	5	red
2AA 001 200-012	1	red, Pro-fit pack
2AA 001 200-021	5	green
2AA 001 200-023	1	green, Pro-fit pack
2AA 001 200-031	5	amber
<hr/>		
2AA 001 200-041	5	Warning light with blade terminal contacts, blue
2AA 001 200-131	5	red
2AA 001 200-141	5	green
2AA 001 200-151	5	amber
<hr/>		
Spare parts:		
8GP 002 095-121	10	W5/1.2 bulb, 12V
8GP 002 095-241	10	24V

For dashboards with thickness of up to 1.5 mm.

With blade terminal connections and clamp fixing.

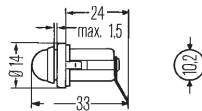

Part no.	Pk.	
2AA 001 201-011	10	Warning light, red
<hr/>		
Spare parts/Accessories:		
9EL 043 137-001	10	Lens J bulb,
8GP 002 066-121	10	12V
8GP 002 066-241	10	24V

For dashboards with thickness of up to 5.2 mm.

With black cap, dust and waterproof, combined screw/blade terminal contacts.

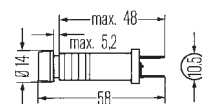

Part no.	Pk.	
2AA 003 257-001	1	Warning light, red
2AA 003 257-011	1	blue
2AA 003 257-021	1	green
2AA 003 257-031	1	amber
<hr/>		
2AA 003 257-041	1	Warning light with 4 lenses (red, blue, green, amber) included loose and 12V bulb. Carded
2AA 003 257-042	12	Pro-fit pack
<hr/>		
Spare parts:		
8GP 002 066-121	10	J bulb, 12V
8GP 002 066-241	10	24V



Hazard flasher lights

2897

Amber lens. With 6V bulb.

Black body, with folding supporting legs; rubber shoes ensure extreme stability (up to gale force 9).

For use with five U2-type, single-cell, leak proof, 1.5V batteries. Batteries are not supplied with light. National type test for Germany.



Part no.	Pk.	
2XW 002 897-051	1	Hazard flasher light with plastic container
2XW 002 897-041	1	without plastic container
Spare parts/Accessories:		
8GP 002 096-061	10	F bulb, 6V
8XH 002 975-017	16	Plastic container



Combined hazard warning flasher and work lights

3003

Amber lens for hazard flasher, white for work light.

With 6V bulb and black mounting bracket.

Flash frequency > 60 flashes per minute.

Operating time with new alkaline batteries:

Hazard flasher approx. 40 hours, work light approx. 25 hours.

The bulb and reflector pivot to the desired function when the switch above the lens is actuated.

The light exit angle on the work light can be varied by moving the feet to three different positions.

The light is stable up to a wind velocity of 9.

Orange-coloured plastic body, feet black plastic with rubber nubs.

5 x 1.5 mono cells (R20 or LR20) not included with light.

With built-in tester for battery capacity.

National type test for Germany.



Part no.	Pk.	
2XW 007 146-001	1	Hazard flasher light
Spare parts:		
8GP 002 096-061	10	F bulb, 6V

Combined hazard warning flasher and work lights

3003 Accu

Amber lens for hazard flasher, white for work light.
 With 6V bulb and black mounting bracket.
 Flash frequency > 60 flashes per minute.
 Power supply: 6V, 3.0AH rechargeable battery.
 Rated voltage 12V and 24V.
 Power supply for charger circuit 10V to 32V.
 Operating time with fully charged battery:
 Hazard flasher approx. 40 hours, work light approx. 7 hours.
 The bulb and reflector pivot to the desired function when the switch above the lens is actuated.
 The light exit angle on the work light can be varied by moving the feet to three different positions.
 The light is stable up to a wind velocity of 9.
 Sulphur-yellow plastic body, feet black plastic with rubber nubs.
 With maintenance-free, rechargeable lead gel battery and charging holder, for connecting to terminal 15 (ignition on) and terminal 31 (earth).
 As soon as the light catches in the holder, the battery in the light starts being charged.
 The charger operates with 12V and 24V systems.
 Switch-over is automatic.
 National type test for Germany.



Part no.	Pk.	
2XW 007 146-011	1	Hazard flasher light
Spare parts:		
8GP 002 096-061	10	F bulb, 6V

2002 Europa

Amber lens for hazard flasher, white for work light.
 With 6V bulb and mounting bracket.
 With folding supporting legs; rubber shoes ensure extreme stability (up to gale force 9).
 For use with five U2-type, single-cell, leak proof, 1.5V batteries. Batteries are not supplied with light.
 National type test for Germany.



Part no.	Pk.	
2XW 003 146-001	1	Hazard flasher light
Spare parts:		
8GP 002 096-061	10	F bulb, 6V

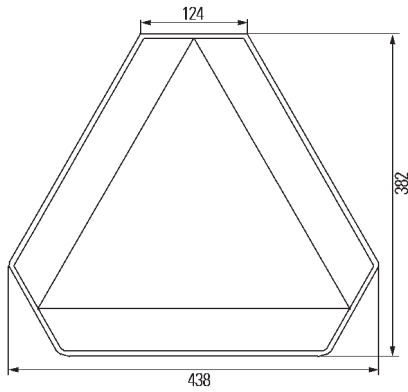

Emergency triangle for slow-moving vehicles

Precision-built, ultra-effective reflectors hit the eye both day and night.
Very light in weight.
Easy to store.
Fastened with metal bracket and strip.

Part no.	Pk.	
8RW 341 235-007	20	Emergency triangle
8HG 341 300-007	10	Accessories: Strip

Reflectors

Reflecting surface 22 sq. cm.
With plastic base plate.
One 6 mm dia. hole for fixing screw.

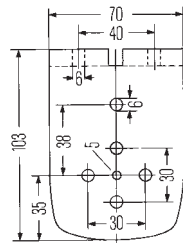
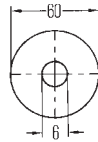
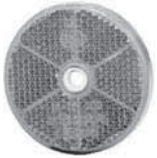

Part no.	Pk.	
8RA 002 014-231	25	Reflector, red
8RA 002 014-232	80	
8RA 002 014-251	25	amber
8RA 002 014-252	80	
8RA 002 014-257	1000	
8RA 002 014-872	1	Reflector set, yellow, 2 pieces
8RA 002 014-241	25	Reflector, white
8RA 002 014-242	80	
8RA 002 014-327	100	with rubber holder 8HG 003 799-001, white
8HG 003 799-001	2	Accessories: Rubber holder
8HG 003 799-007	100	
8HG 003 799-017	1	

Reflecting surface 22 sq. cm.
With plastic base plate, self-adhesive.

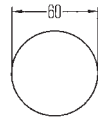

Part no.	Pk.	
8RA 002 014-281	25	Reflector, red
8RA 002 014-301	25	amber
8RA 002 014-291	25	white

Reflectors

Reflecting surface 20 sq. cm.

Metal base plate with central M5 x 15 fixing screw.

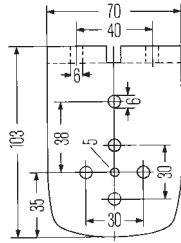
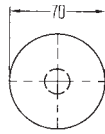

Part no.	Pk.	
8RA 002 015-031	20	Reflector with rubber rim, red
8HG 003 799-001	2	Accessories: Rubber holder
8HG 003 799-007	100	
8HG 003 799-017	1	Hard rubber holder

Reflecting surface 38 sq. cm.

With central M5 x 15 fixing screw.

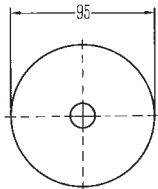
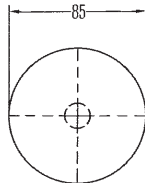

Part no.	Pk.	
8RA 002 016-111	32	Reflector with plastic base plate and rim, red
8RA 002 016-101	20	white
8RA 002 016-121	20	Reflector with PVC rim and base plate, red

Reflecting surface 18 sq. cm.

Self-adhesive, for horizontal or vertical mounting.

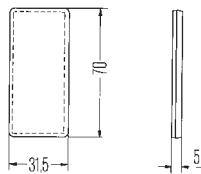

Part no.	Pk.	
8RA 004 412-021	20	Reflector, red
8RA 004 412-001	20	amber
8RA 004 412-011	20	white

Reflecting surface 20.9 sq. cm.

Self-adhesive, for horizontal or vertical mounting.

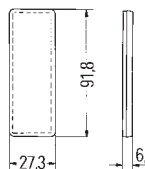

Part no.	Pk.	
8RA 342 014-157	100	Reflector, red

Reflectors

Reflecting surface 29 sq. cm.
With plastic base plate.
For horizontal or vertical mounting.

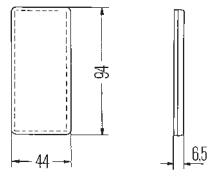
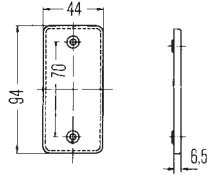
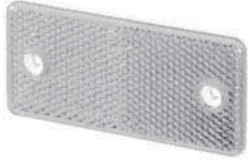

Part no.	Pk.	
8RA 003 326-001	20	Reflector with two 4.3 mm dia. holes for fixing screws, red
8RA 003 326-002	200	
8RA 003 326-011	20	amber
8RA 003 326-017	200	
8RA 003 326-021	20	white
8RA 003 326-031	20	Reflector self-adhesive, red
8RA 003 326-931	1	
8RA 003 326-041	20	amber
8RA 003 326-047	200	
8RA 003 326-051	20	white

Reflecting surface 50 sq. cm.
With plastic base plate.
Self-adhesive, for horizontal or vertical mounting.

Part no.	Pk.	
8RB 004 713-001	20	Reflector, amber

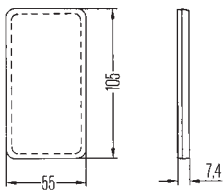

Reflectors

Reflecting surface 47 sq. cm.
With plastic base plate.

Two 6 mm dia. holes for fixing screws.
For horizontal or vertical mounting.

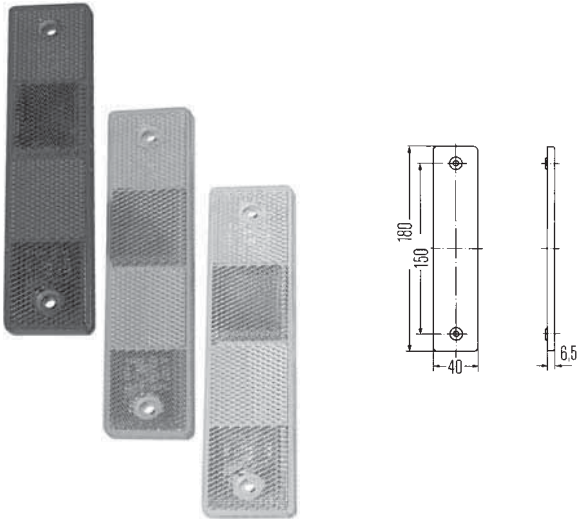

Part no.	Pk.	Reflector,
8RA 002 023-001	20	red
8RA 002 023-021	20	amber
8RA 002 023-011	20	white

Reflecting surface 60 sq. cm.
With plastic base plate.

Two 6.5 mm dia. holes for fixing screws.
For horizontal or vertical mounting.

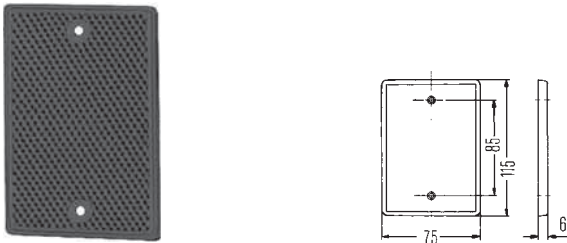

Part no.	Pk.	Reflector,
8RL 002 009-021	20	red

Reflecting surface 101 sq. cm.
With plastic base plate.

Two M6 x 12 fixing screws.
For horizontal or vertical mounting.

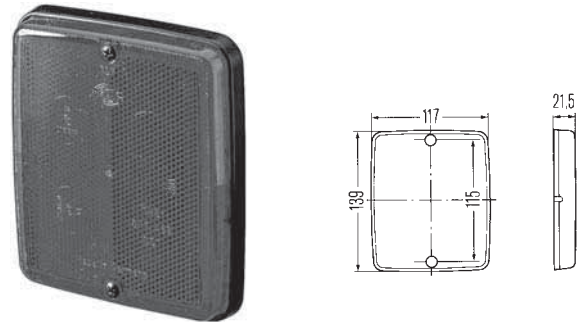

Part no.	Pk.	Reflector,
8RA 003 660-007	8	red

Reflecting surface 54 sq. cm.
With rubber base plate.

Two B3.9 x 22 fixing screws.
For horizontal or vertical mounting.

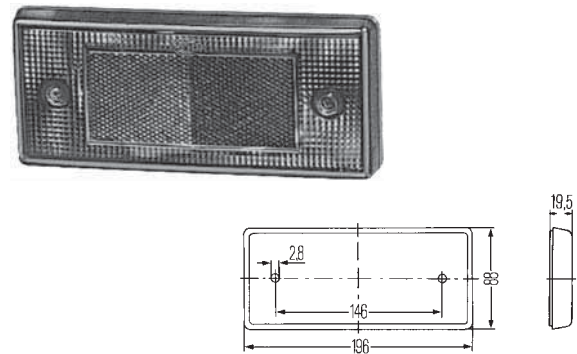

Part no.	Pk.	Reflector,
8RA 003 734-101	1	red

Reflectors

Reflecting surface 95 sq. cm.
Reflector thickness 8.2 mm.

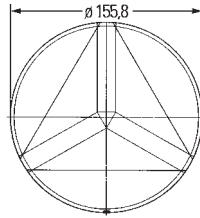
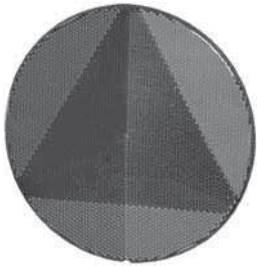
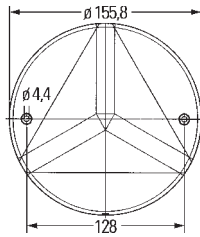
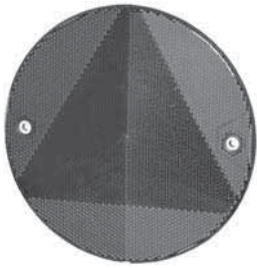

Part no.	Pk.	Description
8RA 343 220-017	30	Triangular reflector, red with two holes for fixing screws
8RA 343 220-007	30	self-adhesive

Reflecting surface 85 sq. cm.

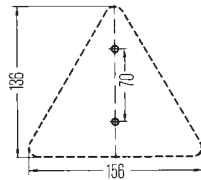

Part no.	Pk.	Description
8RA 002 020-001	25	Triangular reflector with plastic base plate and two 6 mm dia. holes for fixing screws, red
8RA 002 020-002	120	
8RA 002 020-051	10	Triangular reflector with plastic base plate and additional metal base plate, two M5 x 20 fixing screws, red
8RA 002 020-031	10	Triangular reflector with plastic base plate and sendzimir galvanized mounting bracket for compensating inclination, two 3.7 mm dia. holes for fixing screws, red

Reflecting surface 57 sq. cm.
Two M5 fixing screws.

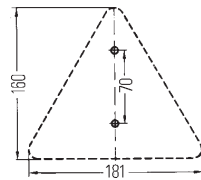

Part no.	Pk.	Description
8RA 003 503-001	16	Triangular reflector, quadrifid, red



Flexible supports for reflectors

PVC-covered steel strip.

Two M5 x 20 fixing screws.

Distance between screws: 25 up to 36 mm.

Three 6.3 mm dia. holes.

Distance between holes for fixing reflectors 50 x 70 mm.

Part no.	Pk.	
8HG 002 240-001	10	Support for reflector, length 200 mm, width 51 mm
8HG 002 240-021	10	length 300 mm, width 51 mm
8HG 002 240-031	10	length 400 mm, width 51 mm

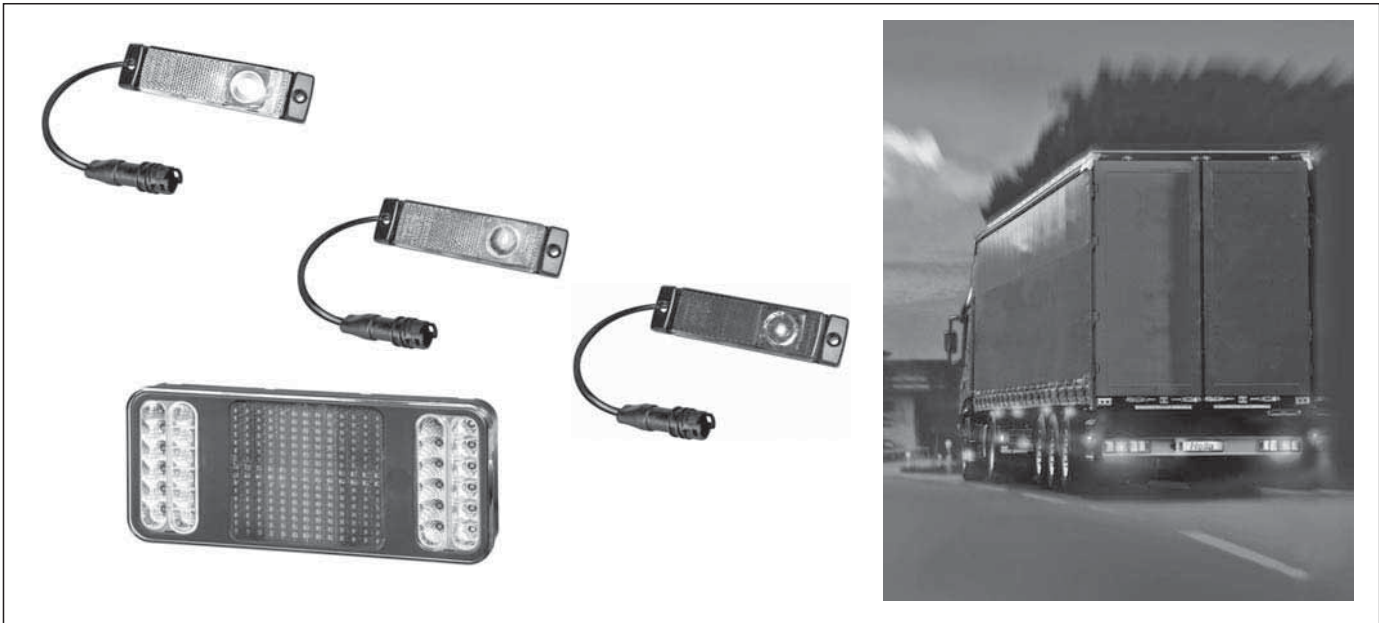

Signal lights and cabling for towing vehicles, trailers and semi-trailers

Signal lights and cabling - front

2.262-2.264

Signal lights and cabling - side

2.265-2.270

Signal lights and cabling - rear

2.271-2.328

Accessories

2.329-2.330

Cabling

2.331-2.338

Position lights

Front



For horizontal or vertical surface mounting on towing vehicles and trailers

When attached horizontally, the optical field must point toward the outside of the vehicle. In LED-technology. With 1 white LED 24V1.2W. Clear lens with reflector.

Consumption at 24V: 0.04A.

Black body. Two holes for B4.2 fixing screws.

Type de protection: IP6K9K. See LED instruction 2.

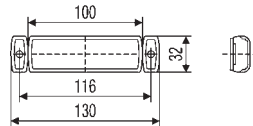

Part no.	Pk.	
2PG 008 645-971	1	Position light with reflector with 500 mm long lead
2PG 008 645-961	1	with 5000 mm long lead
2PG 008 645-831	1	with 450 mm long lead and 2-pole AMP-Superseal plug connector
2PG 008 645-321	1	with 300 mm long lead and 2-pole EasyConn socket
2PG 008 645-331	1	with 1300 mm long lead and 2-pole EasyConn socket
2PG 008 645-631	1	with 300 mm quick-link lead attachment incl. clamping piece for contacting a two-core flat lead
2PG 008 645-541	1	with 1300 mm long lead and quick-link lead attachment incl. clamping piece for contacting a 2-core flat lead,
2PG 008 645-641	1	with 5000 mm quick-link lead attachment incl. clamping piece for contacting a two-core flat lead
Accessories:		
9GD 157 876-007	55	Gasket
8PE 008 932-001	1	Mounting pliers for quick-link lead attachment
8HG 340 489-001	1	Holder, angled back
8HG 340 413-001	1	Clip angle, rear
8KW 998 602-002	1	Clamping piece for quick-link lead attachment
8HG 160 409-002	10	Holder with two fixing screws

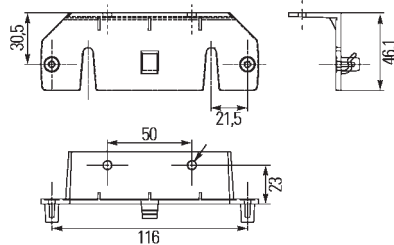

For horizontal or vertical surface mounting on towing vehicles and trailers

In LED-technology. Clear lens.

White light. With 1 white LED 0.5W.

Consumption: 0.04A at 12V, 0.02A at 24V.

With gasket covers for fixing holes.

Voltage range: 10V - 33V. See LED instruction 2.

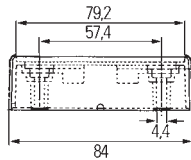
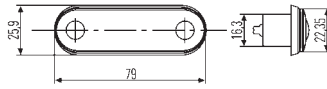

Part no.	Pk.	
2PF 959 590-202	2	Position light with 500 mm long lead
2PF 959 590-212	2	with 5000 mm long lead
9XD 160 867-007	16	Accessories: Bracket (adapter) for mounting the lights

For horizontal surface mounting on towing vehicles

In LED-technology. Clear lens.

White light. With 1 white LED 0.8W.

Consumption with 1 LED: 0.05A at 12V, 0.03A at 24V.

Black plastic body.

Voltage range: 10V - 33V. See LED instruction 2.

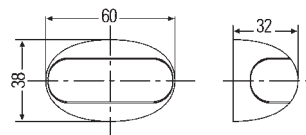

Part no.	Pk.	
2PF 959 570-202	2	Position light with 500 mm long lead
2PF 959 570-212	2	with 5000 mm long lead

For flush mounting in towing vehicles and trailers

In LED-technology. Clear lens, without reflector.

White light. With 2 white LEDs 24V0.9W.

Consumption: 0.04A at 24V.

See LED instruction 2.

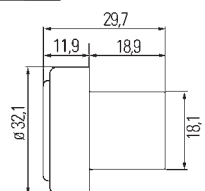
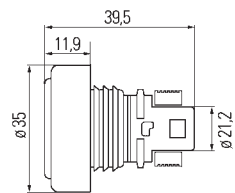

Part no.	Pk.	
2PF 340 825-001	1	Position light with black rubber body, fins and 2-pole EasyConn socket
2PF 340 825-057	50	with black plastic body, 500 mm long lead and 2-pole Superseal plug connector. With adhesive tape for sticking to surfaces, polarity-independent

Position lights

Front



For horizontal surface mounting on towing vehicles and trailers

**In LED-technology. Clear lens with reflector.
With 2 white LEDs 24V0.5W.**

Consumption: 0.02A at 24V.
White base plate.
Two 5.5 mm dia. holes for fixing screws.
See LED instruction 2.

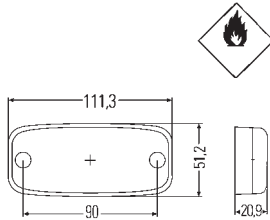

Part no.	Pk.	
2PG 345 600-401	1	Position light with reflector with 500 mm long lead
2PG 345 600-411	1	with 5000 mm long lead
9GD 341 063-007	20	Accessories: Gasket

For horizontal flush mounting on towing vehicles

**In LED-technology. Clear lens.
With 2 white Power LEDs 24V0.5W.**

Consumption: 0.02A at 24V. Black rubber body.
2 holes in the lens for attachment of the light using 2 PT screws 5 x 25 Torx and 2 washers Ø 4.2 mm (not part of the scope of supply).
Tightening torque max. 2 Nm. See LED instruction 2.

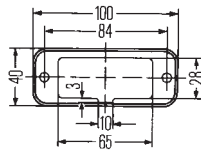

Part no.	Pk.	
2PF 009 514-001	1	Position light for installation positions 10° - 20°
2PF 009 514-011	1	for installation positions 20° - 30°

For horizontal surface mounting on towing vehicles and trailers

Clear lens with reflector.
With black plastic base plate and insert gasket.
Two ST4.2 x 16 fixing screws.
Type of protection: IP54K and IP59K.

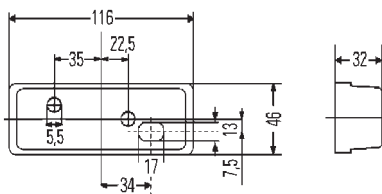

Part no.	Pk.	
2PG 003 748-151	4	Position light with reflector
9EL 148 274-001	2	Spare parts/Accessories: Lens
8GP 002 067-121	10	T4W bulb,
8GP 002 067-241	10	12V
		24V

**For flush mounting
in towing vehicles and trailers**

**In LED-technology. Amber lens.
Amber light. With 2 LEDs 12V0.7W.**

Consumption: 0.06A at 12V.
Type of protection: IP6K6X.
See LED instruction 2.

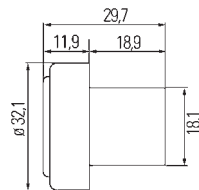
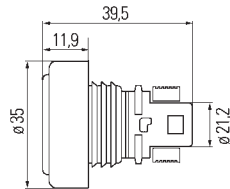

Part no.	Pk.	
2BM 340 825-201	1	Auxiliary indicator with black rubber body, fins and 2-pole EasyConn socket
2BM 340 825-207	50	
2BM 340 825-211	1	with black rubber body, fins and 100 mm long lead with 2-pole AMP Superseal plug connector
2BM 340 825-217	50	
2BM 340 825-301	1	with black rubber body, fins and 100 mm long lead with 6.3 mm blade terminals
2BM 340 825-307	50	
2BM 340 825-311	1	with black plastic body, adhesive tape and 100 mm long lead with 2-pole AMP Superseal plug connector
2BM 340 825-317	50	

Side-marker lights

Side



For horizontal surface mounting

In LED-technology. With 2 LEDs.

Amber lens with reflector.

Consumption: 0.04A at 24V.

See LED instruction 2.

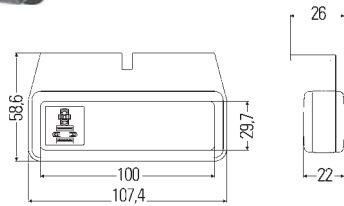
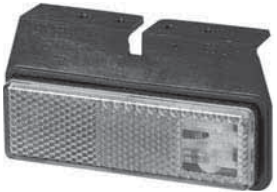
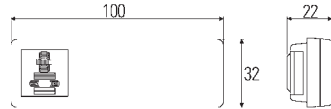

Part no.	Pk.	
2PS 008 616-001	1	Side-marker light with reflector without angular bracket, 24V1.0W
2PS 008 616-011 2PS 008 616-017	1 30	with bracket, angled backwards, 24V1.0W

For horizontal flush/surface mounting

In LED-technology. With 2 LEDs.

Amber lens with reflector.

Black plastic body.

Consumption: 0.06A at 12V/24V.

See LED instruction 2.

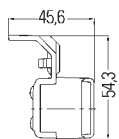
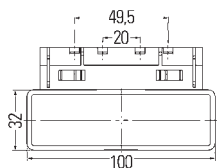
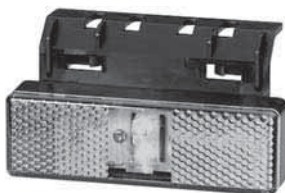
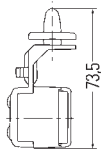
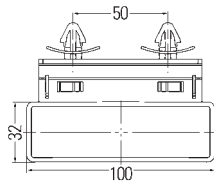
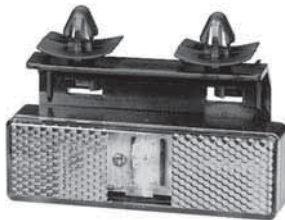
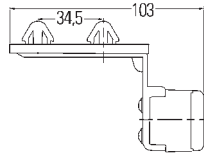
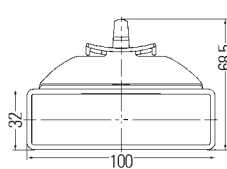
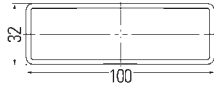

Part no.	Pk.	
2PS 008 643-007	300	Side-marker light with reflector for flush mounting, 24V1.4W
2PS 008 643-011 2PS 008 643-017	1 30	with bracket, angled backwards, 24V1.4W
2PS 008 643-021 2PS 008 643-027	1 30	with bracket, angled forwards, 24V1.4W
2PS 008 643-331	1	with universal bracket, angled backwards, 12V0.7W
2PS 008 643-031 2PS 008 643-037	1 30	with universal bracket, angled forwards, 24V1.4W

Side-marker lights

Side



For horizontal or vertical surface mounting on towing vehicles and trailers

When attached horizontally, the optical field must point toward the outside of the vehicle.
In LED-technology. Amber lens with reflector.
With 1 amber LED 24V1.2W.

Consumption: 0.04A.

Black body. Two holes for B4.2 fixing screws.

Type of protection: IP6K9K. See LED instruction 2.

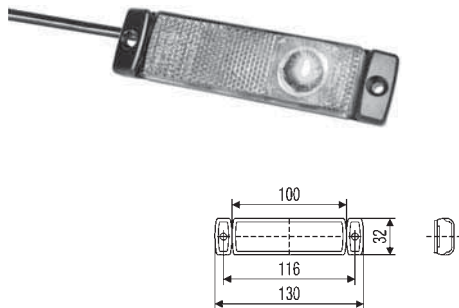

Part no.	Pk.	Description
2PS 008 645-001	1	Side-marker light with reflector for horizontal surface mounting, with 1500 mm long lead
2PS 008 645-787	50	for horizontal surface mounting, with 1300 mm long lead
2PS 008 645-891	50	for horizontal surface mounting, with 500 mm long lead and 2-pole AMP-Superseal plug connector
2PS 008 645-991	1	for vertical surface mounting, with 1500 mm long lead



2PS 008 645-301 1 Side-marker light with reflector for horizontal surface mounting, with 2-pole EasyConn socket, with 300 mm long lead



2PS 008 645-311 1 with 1300 mm long lead



2PS 008 645-361 1 with 2000 mm long lead



2PS 008 645-611 1 Side-marker light with reflector for horizontal surface mounting, with quick-link lead attachment incl. clamping piece for contacting a 2-core flat lead, with 300 mm long lead



2PS 008 645-717 50 with 500 mm long lead



2PS 008 645-621 1 with 1300 mm long lead



2PS 008 645-797 50 with 150 mm long lead and bracket

- Accessories:**
- 9GD 157 876-007 55 Gasket
 - 8PE 008 932-001 1 Mounting pliers for quick-link lead attachment
 - 8HG 340 489-001 1 Holder, angled back
 - 8HG 340 413-001 1 Clip angle, rear
 - 8KW 998 602-002 1 Clamping piece for quick-link lead attachment

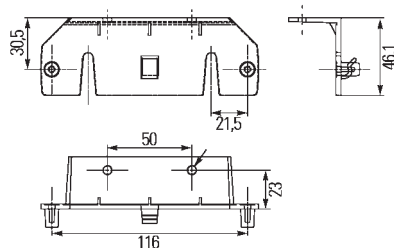

8HG 160 409-002 10 Holder with two fixing screws

For horizontal or vertical surface mounting on towing vehicles and trailers

OneLED

In LED-technology. Amber lens with reflector.

With 1 LED 24V1.0W.

Consumption: 0.04A.

Black body. See LED instruction 2.

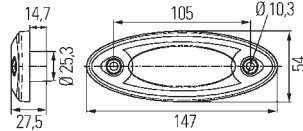

Part no.	Pk.	
2PS 344 690-037	96	Side-marker light with reflector with 6.3 mm blade terminal contacts
9GD 343 697-007	50	Accessories: Gasket, black

For horizontal surface mounting on towing vehicles and trailers

Amber lens with reflector.

Type of protection: IP54K and IP59K.

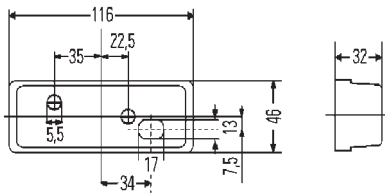

Part no.	Pk.	
2PS 003 748-121	4	With black plastic base plate and gasket. Two ST4.2 x 16 fixing screws. Side-marker light with reflector

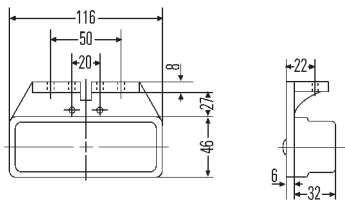

2PS 003 748-161	4	With black plastic base, inserted gasket and reinforced plate, four PT4 x 16 fixing screws and rubber mount. Side-marker light with reflector, holder mounting surfaces points towards the front
9EL 147 910-001	2	Spare parts/Accessories: Lens
8GP 002 067-121	10	T4W bulb, 12V
8GP 002 067-241	10	24V

Side-marker lights

Side



For horizontal surface mounting on towing vehicles and trailers

In LED-technology. Amber lens with reflector.
With 2 LEDs 24V1.3W.

Consumption: 0.05A.
Black base plate.
Two 5.5 mm dia. holes for fixing screws.
See LED instruction 2.

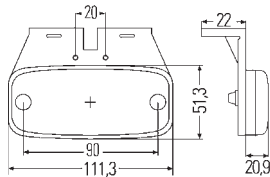
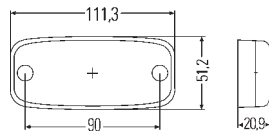

Part no.	Pk.	
2PS 345 600-011	1	Side-marker light with reflector without bracket, with 500 mm long lead
2PS 345 600-071	1	with bracket, angled back and 500 mm long lead
9GD 341 063-007	20	Accessories: Gasket

Amber lens with reflector.
With 24V bulb.

With transverse clip angle, front.
Contacting via splice clamp connection.

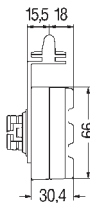
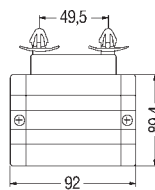

Part no.	Pk.	
2PS 340 000-011	1	Side-marker light with reflector
8GM 002 092-241	10	Spare parts/Accessories: C5W bulb, 24V
9GS 340 051-001	20	Heat-shrink end cap up to max. 11 mm long lead diameter

For horizontal or vertical surface mounting on towing vehicles and trailers

Amber lens with reflector.

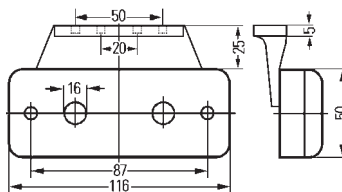
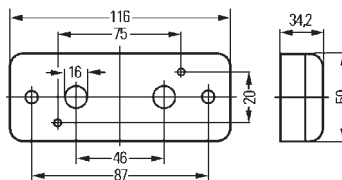

Part no.	Pk.	
2PS 963 959-001	4	Side-marker light with reflector with 2 PG screw connections
2PS 963 959-011	4	with rubber bracket
8GP 002 067-121	10	Spare parts/Accessories: T4W bulb, 12V
8GP 002 067-241	10	24V
8GP 002 067-261	10	24V (HD)

For horizontal surface mounting on trailers

Full-LED combination rear lights

Clear lens. With pulse for indicator failure check.

Rear-/stop light with 7 red LEDs, indicator light with 7 amber LEDs, reverse light with 6 white LEDs, rear fog light with 7 red LEDs.

Rear light: 10.0W, stop light: 13.0W, indicator light: 3.0W, rear fog light: 2.5W, reverse light: 2.5W, clearance light: 1.2W.

Consumption at 24V:

rear light: 0.42A, stop light: 0.54A, indicator light: 0.13A, reverse light: 0.10A, rear fog light: 0.10A, clearance light: 0.05A, side marker reflector: 0.04A.

Black plastic body.

Two M8 fixing screws.

Type of protection LED module: IP6K9K.

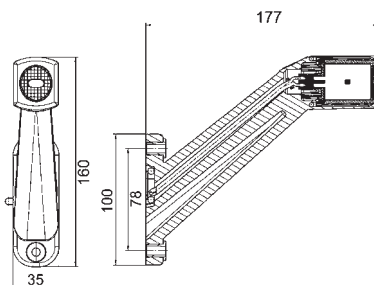
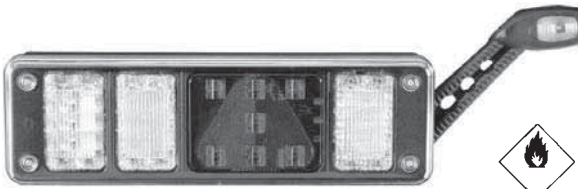
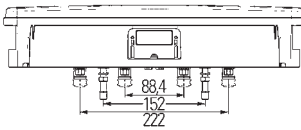
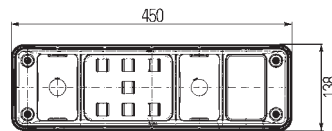

Part no.	Pk.	
2VP 340 960-011	1	Rear-triangular reflector-stop-indicator-rear fog-reverse light with 7-pole EasyConn plug connector and 4 x 2-pole plug, left
2VP 340 960-021	1	right
2VP 340 960-271	1	Rear-triangular reflector-stop-indicator-rear fog-reverse light with 7-pole AMP plug connector and 4 x 2-pole AMP Superseal plug connector, left
2VP 340 960-281	1	right
2VP 340 960-111	1	Rear-triangular reflector-stop-indicator-rear fog-reverse light with clearance light in the rubber arm, with 7-pole EasyConn plug connector and 4 x 2-pole plug, left
2VP 340 960-121	1	right
9EL 183 432-001	1	Spare parts/Accessories: Lens LED module
9DW 178 904-001	1	for rear/stop light
9DW 178 909-001	1	for indicator light
9DW 178 909-021	1	for rear fog light
9DW 178 909-011	1	for reverse light
2XS 011 744-011	1	for clearance light, left
2XS 011 744-021	1	for clearance light, right

Signal lights

Rear



For horizontal surface mounting on trailers

Hybrid rear lights

With LEDs and bulbs.

Clear lens. With 7-pole EasyConn plug connector, 4x 2-pole plug for connection of diverse functions and pulse for indicator failure check.

Necessary protective cover for surface mounting 8XS 340 092-011, order separately.

Consumption at 24V:

rear light: 0.01A, stop light: 0.83A, indicator light: 0.13A, rear fog light: 0.10A, reverse light: 0.10A, clearance light: 0.05A.

Black plastic body.

Two M8 fixing screws.

Type of protection light: IP5K4K, LED module: IP6K9K.

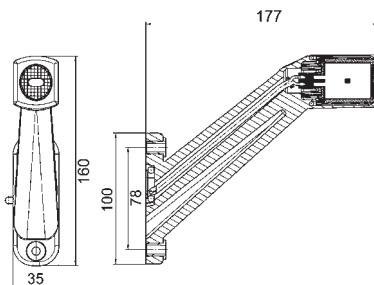
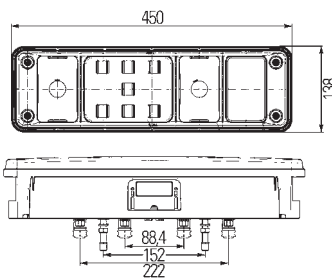

Part no.	Pk.	
2VP 340 961-011	1	LED-functions: rear light, stop light Bulb-functions: indicator light, rear fog light, reverse light Rear-triangular reflector-stop-indicator-rear fog-reverse light, left
2VP 340 961-021	1	Rear-triangular reflector-stop-indicator-rear fog-reverse light, right
2VP 340 961-031	1	LED-functions: rear light, stop light, indicator light, reverse light Bulb-functions: rear fog light, reverse light Rear-triangular reflector-stop-indicator-rear fog-reverse light, left
2VP 340 961-041	1	Rear-triangular reflector-stop-indicator-rear fog-reverse light, right
2VP 340 961-111	1	LED-functions: rear light, stop light, clearance light Bulb-functions: indicator light, rear fog light, reverse light Rear-triangular reflector-stop-indicator-rear fog-reverse light with clearance light in the rubber arm, left
2VP 340 961-121	1	Rear-triangular reflector-stop-indicator-rear fog-reverse light with clearance light in the rubber arm, right
9EL 183 432-001	1	Spare parts/Accessories: Lens LED module
9DW 178 904-001	1	for rear/stop light
9DW 178 909-001	1	for indicator light
9DW 178 909-021	1	for rear fog light
9DW 178 909-011	1	for reverse light
2XS 011 744-011	1	for clearance light, left
2XS 011 744-021	1	for clearance light, right
8GA 002 073-241	10	P21W bulb, 24V
8GA 006 841-241	10	PY21W bulb, 24V
8XS 340 092-011	1	Protective hood

For surface mounting

EasyConn retrofit set, 24V

Contents:
 signal light with LEDs and bulbs, left and right
 licence plate light with LEDs
 caps
 covers
 lead, left and right
 accessories



Part no.	Pk.	
9XX 340 369-011	1	Retrofit set, 24V. Contents:
		LED-functions: rear light, stop light, clearance light Bulb-functions: indicator light, rear fog light, reverse light
		Rear-triangular reflector-stop-indicator-rear fog-reverse light with clearance light in the rubber arm, left
2VP 340 961-111	1	
		Rear-triangular reflector-stop-indicator-rear fog-reverse light with clearance light in the rubber arm, right
2VP 340 961-121	1	
2KA 010 278-071	1	Licence plate light with 1350 mm long lead and 2-pole EasyConn angular plug
9HV 340 812-007	1	Cap for free connections of the left and right signal light
8XS 340 092-011	1	Cover for signal light
8JE 340 151-001	1	Distributor box, please order separately if required

For horizontal surface mounting on trailers

Hybrid rear lights

With LEDs and bulbs.

Clear lens. With 7-pole EasyConn plug connector, 4x 2-pole plug for connection of diverse functions and pulse for indicator failure check.

Necessary protective cover for surface mounting 8XS 340 092-011, order separately.

Consumption at 24V:

rear light: 0.01A, stop light: 0.83A, indicator light: 0.13A, rear fog light: 0.10A, reverse light: 0.10A, clearance light: 0.05A, side marker reflector: 0.04A.

Black plastic body.

Two M8 fixing screws.

Type of protection light: IP5K4K, LED module: IP6K9K.

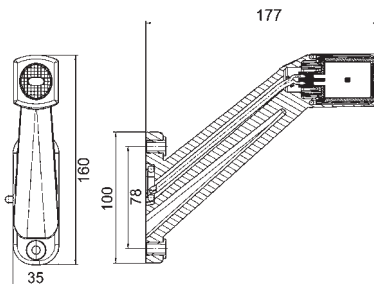
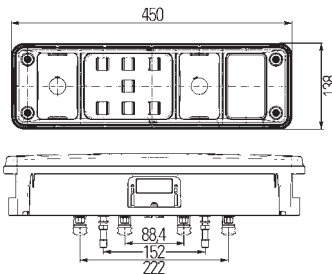

Part no.	Pk.	
		LED-functions: rear light, stop light, rear fog light, clearance light Bulb-functions: indicator light, rear fog light, reverse light Rear-triangular reflector-stop-indicator-rear fog-reverse light with clearance light in the rubber arm, left
2VP 340 961-131	1	
		Rear-triangular reflector-stop-indicator-rear fog-reverse light with clearance light in the rubber arm, right
2VP 340 961-141	1	
		LED-functions: Rear light, stop light, side marker light Bulb-functions: Indicator light, rear fog light, reverse light Rear-triangular reflector-stop-indicator-rear fog-reversing-side marker light, left
2VP 340 961-211	1	
		Rear-triangular reflector-stop-indicator-rear fog-reversing-side marker light, right
2VP 340 961-221	1	
		LED-functions: Rear light, stop light, rear fog light, clearance light Bulb-functions: Indicator light, reverse light Rear-triangular reflector-stop-indicator-rear fog-reverse light with clearance light in the rubber arm, left
2VP 340 961-151	1	
		Rear-triangular reflector-stop-indicator-rear fog-reverse light with clearance light in the rubber arm, right
2VP 340 961-161	1	
		Spare parts/Accessories: 1 Lens 1 LED module 1 for rear/stop light 1 for indicator light 1 for rear fog light 1 for reverse light 1 for clearance light, left 1 for clearance light, right 10 P21W bulb, 24V 10 PY21W bulb, 24V 1 Protective hood
9EL 183 432-001	1	
9DW 178 904-001	1	
9DW 178 909-001	1	
9DW 178 909-021	1	
9DW 178 909-011	1	
2XS 011 744-011	1	
2XS 011 744-021	1	
8GA 002 073-241	10	
8GA 006 841-241	10	
8XS 340 092-011	1	

For horizontal surface mounting on trailers

Hybrid rear lights

With LEDs and bulbs.

Clear lens. With 7-pole AMP plug connector, 4x 2-pole plug for connection of diverse functions and pulse for indicator failure check.

Necessary protective cover for surface mounting 8XS 340 092-011, order separately.

Consumption at 24V:

rear light: 0.42A, stop light: 0.54A, indicator light: 0.13A,

rear fog light: 0.10A, reverse light: 0.10A, clearance light: 0.05A.

Black plastic body.

Two M8 fixing screws.

Type of protection light: IP5K4K, LED module: IP6K9K.

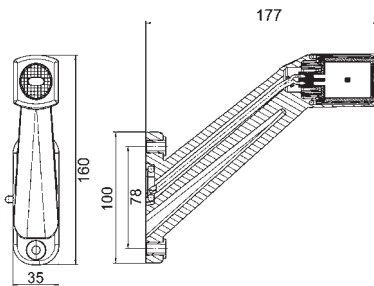
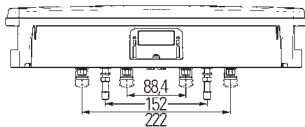
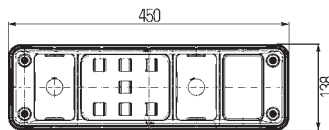

Part no.	Pk.	
		LED-functions: rear light, stop light Bulb-functions: indicator light, rear fog light, reverse light
2VP 340 961-411	1	Rear-triangular reflector-stop-indicator-rear fog-reverse light, left
2VP 340 961-421	1	Rear-triangular reflector-stop-indicator-rear fog-reverse light, right
		LED-functions: rear light, stop light, clearance light Bulb-functions: indicator light, rear fog light, reverse light
2VP 340 961-431	1	Rear-triangular reflector-stop-indicator-rear fog-reverse light with clearance light in the rubber arm, left
2VP 340 961-441	1	Rear-triangular reflector-stop-indicator-rear fog-reverse light with clearance light in the rubber arm, right
9EL 183 432-001	1	Spare parts/Accessories: Lens
9DW 178 904-001	1	LED module
2XS 011 744-011	1	for rear/stop light
2XS 011 744-021	1	for clearance light, left
8GA 002 073-241	10	for clearance light, right
8GA 006 841-241	10	P21W bulb, 24V
8XS 340 092-011	1	PY21W bulb, 24V
		Protective hood

Signal lights

Rear



For horizontal surface mounting on trailers

EasyConn I rear lights

Red rear, stop, rear fog light and triangular reflector, indicator light (with amber filter) and reverse light smoke colour, amber side marker light.

With vibration damping, 24V bulbs and 500 mm long lead with 7-pole EasyConn plug connector for rear adapter 8KA 340 819-...

Black plastic body.

Two M8 fixing screws.

Two bulbs for rear light.

Type of protection: IP5K9K

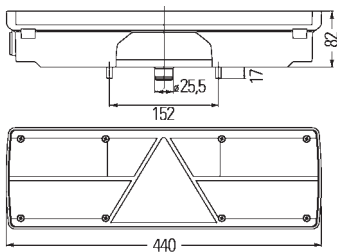
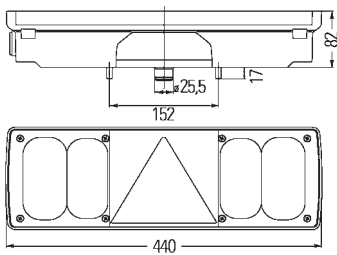

Part no.	Pk.	
2VP 340 450-451	1	Rear-stop-triangular reflector-indicator-rear fog-reversing-side marker light with reflector, left
2VP 340 450-441	1	right
2VP 340 450-511	1	Rear-stop-triangular reflector-indicator-rear fog-reverse-side marker light with reflector, left
2VP 340 450-501	1	right
Spare parts/Accessories:		
9EL 340 208-001	1	Lens, vertically
9EL 340 208-021	1	Lens, horizontally
9EL 146 838-001	2	Lens for side-marker light with reflector
8GA 002 071-241	10	R5W bulb, 24V
8GA 002 073-241	10	P21W bulb, 24V
8GM 002 092-241	10	C5W bulb, 24V

For horizontal surface mounting on trailers

EasyConn I rear lights

Red rear, stop, rear fog light and triangular reflector, indicator light (with amber filter) and reverse light smoke colour, amber side marker light.

With vibration dampers and 24V bulbs.

Black plastic body.

Two M8 fixing screws.

Two bulbs for rear light.

Type of protection: IP5K9K

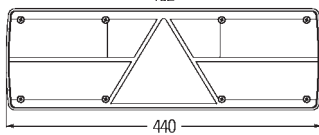
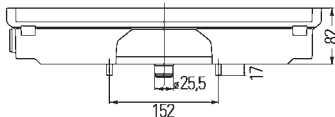
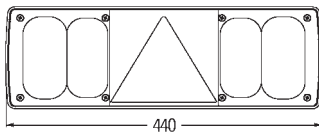
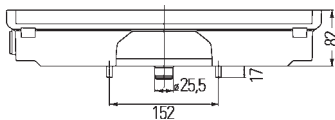

Part no.	Pk.	
2VP 340 450-031	1	Rear-stop-triangular reflector-indicator-rear fog-reverse-side marker light with reflector, with lead retention for 6-core lead, left
2VP 340 450-021	1	right
2VP 340 450-151	1	Rear-stop-triangular reflector-indicator-rear fog light-reverse light-side-marker light with reflector with 1480 mm long lead and 6-pole socket housing, left
2VP 340 450-141	1	right
Spare parts/Accessories:		
9EL 340 208-001	1	Lens for -031/-021
9EL 340 208-021	1	for -151/-141
9EL 146 838-001	2	Lens for side-marker light with reflector
8GA 002 071-241	10	R5W bulb, 24V
8GA 002 073-241	10	P21W bulb, 24V
8GM 002 092-241	10	C5W bulb, 24V

For horizontal surface mounting on trailers

EasyConn I

Red rear, stop, rear fog light and triangular reflector, amber indicator light, clear reverse light.

With lead retention and 4 vibration dampers.
Without central plug and bulbs.

Black plastic body.

Two M8 fixing screws.

Type de protection: IP5K9K

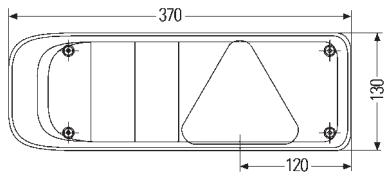
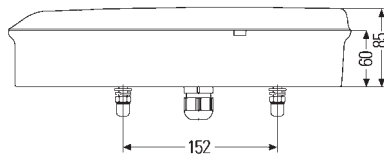
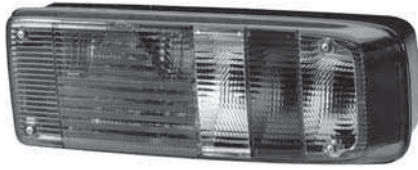

Part no.	Pk.	
2VP 340 831-011	1	Rear-reflector-stop-indicator-rear fog-reverse light, left
2VP 340 831-001	1	right
<hr/>		
2VP 340 931-011	1	Rear-triangular reflector-stop-indicator-rear fog-reverse light, left
2VP 340 931-001	1	right
Spare parts/Accessories:		
9EL 340 829-011	1	Lens with screws for 340 831-..., left
9EL 340 829-001	1	right
9EL 340 829-031	1	Lens with screws for 340 931-..., left
9EL 340 829-021	1	right
8GA 002 071-251	10	R10W bulb, 24V
8GA 002 073-241	10	P21W bulb, 24V

For horizontal surface mounting on trailers

EasyConn I

Red rear, stop, rear fog light and triangular reflector, amber indicator light, clear reverse light, amber side-marker light with reflector.

With 7-pole EasyConn central plug, 4 vibration dampers and 24V bulbs.

Black plastic body.

Two M8 fixing screws.

Type de protection: IP5K9K

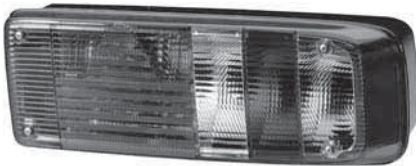

Part no.	Pk.	
2VP 340 830-011	1	Rear-reflector-stop-indicator-rear fog-reverse light, left
2VP 340 830-001	1	right
<hr/>		
2VP 340 930-011	1	Rear-triangular reflector-stop-indicator-rear fog-reverse light with 2 bulbs for rear light, left
2VP 340 930-001	1	right
<hr/>		
2VP 340 830-031	1	Rear-stop-triangular reflector-indicator-rear fog-reversing-side marker light with reflector, left
2VP 340 830-021	1	right
<hr/>		
2VP 340 930-031	1	Rear-triangular reflector-stop-indicator-rear fog-reverse-side-marker light with reflector, with two bulbs for rear light, left
2VP 340 930-021	1	right
<hr/>		
Spare parts:		
9EL 340 829-011	1	Lens with screws for 340 830-..., left
9EL 340 829-001	1	right
9EL 340 829-031	1	Lens with screws for 340 930-..., left
9EL 340 829-021	1	right
8GA 002 071-251	10	R10W bulb, 24V
8GA 002 073-241	10	P21W bulb, 24V

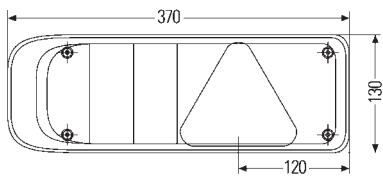
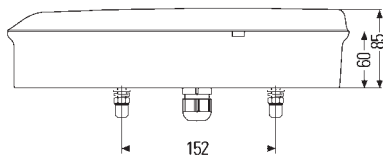
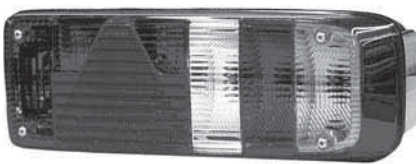

For horizontal surface mounting on trailers

EasyConn I

Red rear, stop, rear fog light and triangular reflector, amber indicator light, clear reverse light.
Inclusive rubber arm with clearance- and side-marker light.
Lens for clearance light red and side-marker light amber.
With 4 vibration dampers.

Black plastic body.
Two M8 fixing screws.
Type de protection: IP5K9K

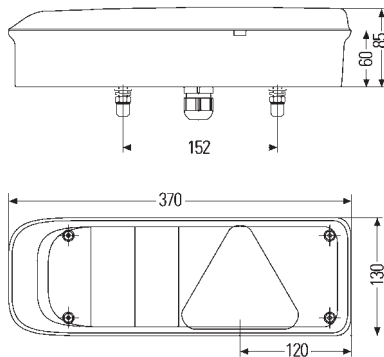

Part no.	Pk.	
		With centre plug and 24V bulbs.
2VP 340 830-111	1	Rear-triangular reflector-stop-indicator-rear fog-reverse-clearance-side-marker light, left
2VP 340 830-101	1	right
		With centre plug and 24V bulbs.
2VP 340 930-111	1	Rear-triangular reflector-stop-indicator-rear fog-reverse-clearance-side-marker light, with 2 bulbs for tail light, left
2VP 340 930-101	1	right
		With PG-lead retention, without bulbs.
2VP 340 931-111	1	Rear-triangular reflector-stop-indicator-rear fog-reverse-clearance-side-marker light, for 2 bulbs for tail light, left
2VP 340 931-101	1	right
		Spare parts:
9EL 340 829-011	1	Lens with screws for 340 830-..., left
9EL 340 829-001	1	right
9EL 340 829-031	1	Lens with screws for 340 930-..., 340 931-..., left
9EL 340 829-021	1	right
8GA 002 071-251	10	R10W bulb, 24V
8GA 002 073-241	10	P21W bulb, 24V
8GP 002 067-241	10	T4W bulb, 24V

For horizontal surface mounting on trailers

EasyConn I hybrid rear lights

Red rear, stop, rear fog light and triangular reflector, amber indicator light, clear reverse light.
With 2 red LEDs for rear light, 24V bulbs, 4 vibration dampers and 7-pole EasyConn socket.

Black plastic body.
Two M8 fixing screws.
Type de protection: IP5K9K

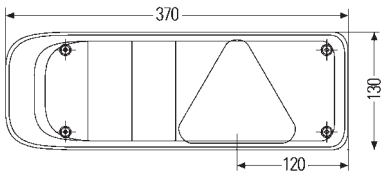
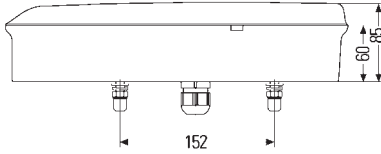
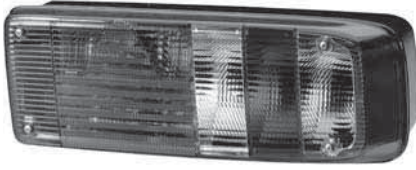

Part no.	Pk.	
2VP 340 932-011	1	Rear-reflector-stop-indicator-rear fog-reverse light, left
2VP 340 932-001	1	right
Spare parts/Accessories:		
9EL 340 829-031	1	Lens with screws, left
9EL 340 829-021	1	right
8GA 002 073-241	10	P21W bulb, 24V

Red rear, stop, rear fog light and triangular reflector, amber indicator light, clear reverse light.

With clearance, position and side-marker light in the rubber arm. With 2 white LEDs for position light, 1 red LED for clearance light, 2 amber LEDs for side-marker light, 24V bulbs, 4 vibration socket dampers and 7-pole EasyConn socket.

Black plastic body.
Two M8 fixing screws.
Type de protection: IP5K9K

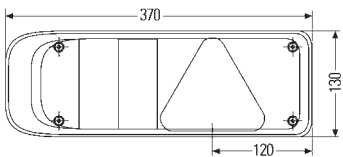
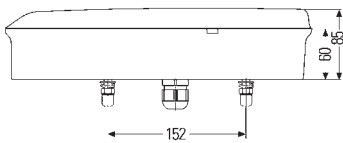

Part no.	Pk.	
2VP 340 934-111	1	Rear-triangular reflector-stop-indicator-rear fog-reverse light with clearance light and side marker light in the rubber arm, left
2VP 340 934-101	1	right
Spare parts/Accessories:		
9EL 340 829-031	1	Lens, left
9EL 340 829-021	1	right
2XS 011 744-171	1	Clearance light, left
2XS 011 744-161	1	right
8GA 002 073-241	1	P21W bulb, 24V

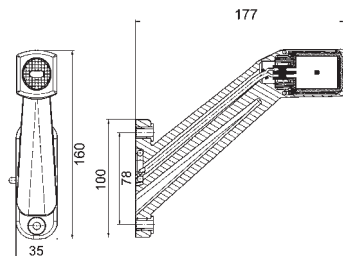

Signal lights

Rear

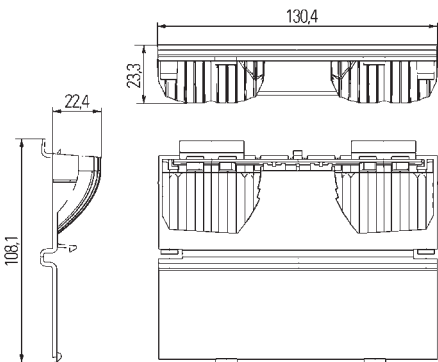
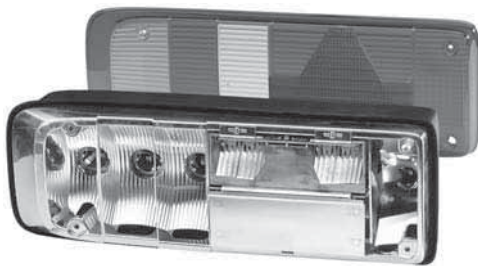

LED retrofit set for rear light

For converting the rear light function from bulbs to LED technology 24V1.0W.

For EasyConn rear lights with bulbs

2VP 340 830-..., 2VP 340 831-..., 2VP 340 930-..., 2VP 340 931-...

Contents:

2 reflectors, one for the right and one for the left light, with one PCB each, including 4 red LEDs and adapter cable to connect to the bulb holder. The PCB is seawater-resistant.

Module can be simply snapped into the reflector.

The two lugs serve for a flat placement of the module.

The type approval number is clearly visible and has been stamped into the right tab. At the same time, the lugs cover the type approval number of the bulb version.

Consumption at 24V: 0.04A.

Part no.	Pk.	
9XX 340 173-801	1	LED retrofit set

For horizontal surface mounting on trailers

EasyConn II hybrid rear lights

Red rear, stop, rear fog light and triangular reflector, amber indicator light, white reverse light.

Rear light behind the triangular reflector in LED-technology.

With 10 red LEDs 2.0W, 24V bulbs,

4 vibration dampers and

7-pole EasyConn central plug.

Consumption (LED) at 24V: 0.08A.

Black plastic body.

Two M8 fixing screws.

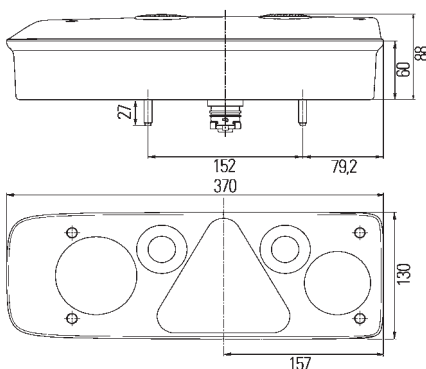
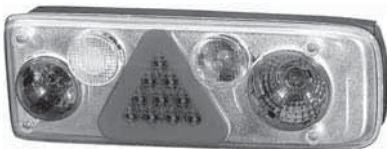

Part no.	Pk.	
2VP 340 942-011	1	Rear-reflector-stop-indicator-rear fog-reverse light, left
2VP 340 942-001	1	right
Spare parts/Accessories:		
9EL 340 331-001	1	Rear-triangular reflector LED module
9EL 340 829-051	1	Lens, left
9EL 340 829-061	1	right
8GA 002 073-241	10	P21W bulb, 24V

For horizontal surface mounting on trailers

EasyConn II hybrid rear lights

Red rear, stop, rear fog light and triangular reflector, amber indicator light, white reverse light. Inclusive rubber arm with clearance light, position light and side-marker light in bulb-technology.

Lens for position light clear, for clearance light red, for side-marker light amber.

With 10 red LEDs 2.0W, 24V bulbs, 4 vibration dampers and 7-pole EasyConn socket.

Consumption (LED) at 24V: 0.08A.

Black plastic body.

Two M8 fixing screws.

Type of protection: IP5K9K.

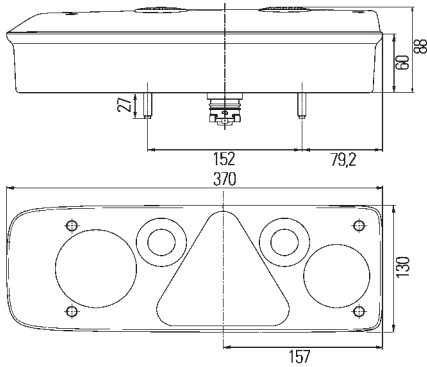

Part no.	Pk.	
2VP 340 942-111	1	Rear-stop-triangular reflector-indicator-rear fog-reverse-clearance-side-marker-position light, left
2VP 340 942-101	1	right
Spare parts/Accessories:		
9EL 340 331-001	1	Rear-triangular reflector LED module
		Lens,
9EL 340 829-051	1	left
9EL 340 829-061	1	right
8GA 002 073-241	10	P21W bulb, 24V
8GA 006 841-241	10	PY21W bulb, 24V
8GP 002 067-241	10	T4W bulb, 24V

Red rear, stop, rear fog light and triangular reflector, amber indicator light, white reverse light.

Inclusive rubber arm with clearance light, position light and side-marker light in LED-technology.

With 2 white LEDs for position light, 1 red LED for clearance light, 2 amber LEDs for side-marker light, 24V bulbs and 4 vibration dampers.

Consumption at 24V: 0.05A.

Black plastic body.

Two M8 fixing screws.

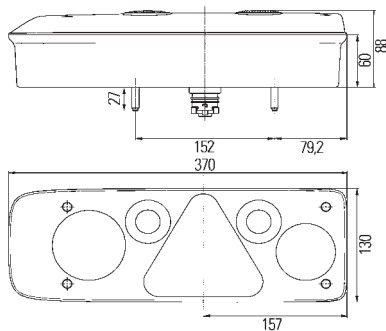

Part no.	Pk.	
2VP 340 940-111	1	Rear-stop-triangular reflector-indicator-rear fog-reverse-clearance-side-marker-position light with 7-pole EasyConn socket, left
2VP 340 940-101	1	right
Spare parts/Accessories:		
9EL 340 331-001	1	Rear-triangular reflector LED module
		Lens,
9EL 340 829-051	1	left
9EL 340 829-061	1	right
		Clearance light,
2XS 011 744-171	1	left
2XS 011 744-161	1	right
8GA 002 073-241	1	P21W bulb, 24V
8GA 006 841-241	10	PY21W bulb, 24V
8GP 002 067-241	10	T4W bulb, 24V

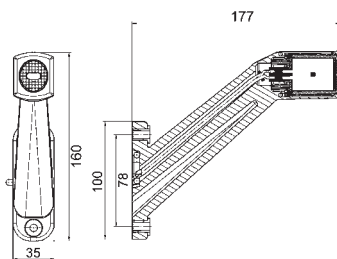

Signal lights

Rear



For horizontal surface mounting on trailers

Full LED rear signal lights

Red rear, stop and triangular reflector, amber indicator light, white reverse light. Tightly glued lens, clear on outside, reflector red on inside. Rear light and stop light with 15 red LEDs, indicator light with 15 amber LEDs, reverse light with 1 white LED. Rear light: 0.7W, stop light: 5.0W, indicator light: 3.0W, reverse light: 5.5W.

Consumption at 24V:
rear light: 0.03A, stop light: 0.21A, indicator light: 0.125A, reverse light: 0.23A.
Black plastic housing.

Ventilation above diaphragm, with pulse for indicator failure check.
Type of protection: IP6K9K. See LED instruction 1.

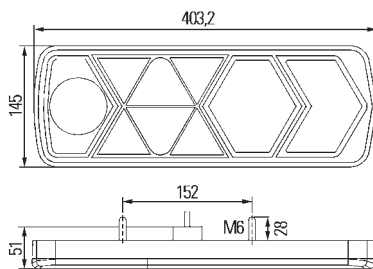
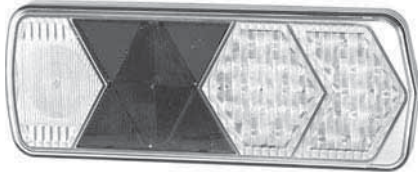

Part no.	Pk.	
2VP 340 950-011	1	Rear-stop-triangular reflector-indicator-reverse light with 500 mm long lead, 7-pole EasyConn socket and additional 2-pole EasyConn connection for rear fog light, left
2VP 340 950-021	1	right
2VP 340 950-031	1	Rear-stop-triangular reflector-indicator-reverse light with 5-core, 1550 mm long lead and 6.3 mm blade terminal contacts, left
2VP 340 950-041	1	with 5-core, 2550 mm long lead and 6.3 mm blade terminal contacts, right

For horizontal surface mounting on towing vehicles

Red rear, stop light and reflector, amber indicator light, white reverse light. With 1500 mm long lead with blade receptacles 6,3 mm. Rear- and stop light each with 15 red LEDs, indicator light with 15 amber LEDs, reverse light with 1 white LED. Rear light: 0.7W, stop light: 5.0W, indicator light: 3.0W, reverse light: 5.5W.

Black plastic body.
Consumption at 24V:
rear light: 0.03A, stop light: 0.21A, indicator light: 0.125A, reverse light: 0.23A.
With pulse for indicator failure check.
Type of protection: IP6K9K. See LED instruction 1.

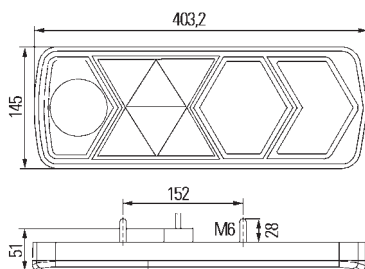

Part no.	Pk.	
2VP 340 950-051	1	Rear-X-reflector-stop-indicator-reverse light, left and right, 24V

For horizontal surface mounting on trailers

Red rear, stop and rear fog light, amber indicator light, white reverse light. With 24V bulbs, vibration dumping and earth lead.

Black plastic body.
Two fixing screws.
Two bulbs for rear light.
Fits combination distributor 8JE 340 060-...

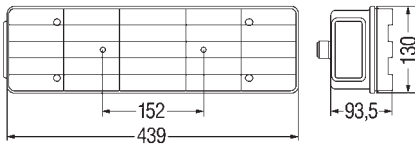

Part no.	Pk.	
2SK 340 101-001	1	Rear-stop-indicator-rear fog-reverse light, left and right, with 1400 mm long lead and 6-pole plug
2SK 340 101-021	1	rear of body with thread, union nut, sealing ring and sealing plug, without lead set
2SK 340 101-011	1	Rear-stop-indicator-rear fog-reverse light-side marker light with reflector, left and right, with 1400 mm long lead and 6-pole plug
2SK 340 101-031	1	rear of body with thread, union nut, sealing ring and sealing plug, without lead set
Spare parts/Accessories:		
9EL 340 201-001	1	Lens
9XX 340 222-001	1	6-pole connection set
8GA 002 073-241	10	P21W bulb, 24V
8GA 002 071-251	10	R10W bulb, 24V

For horizontal or vertical flush/surface mounting on towing vehicles and trailers

Red rear and stop light, amber indicator light, clear licence plate light.

Black plastic body.
Two M8 fixing screws.

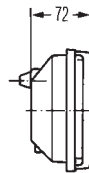
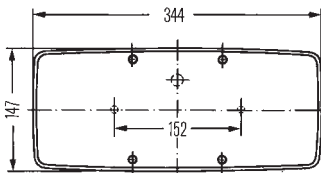
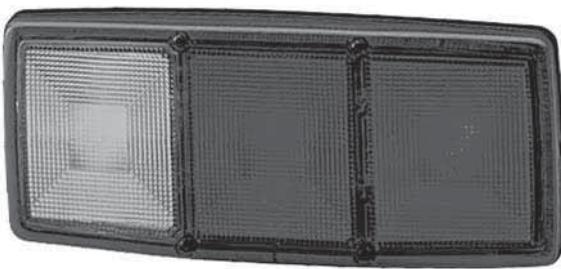

Part no.	Pk.	
2SD 003 167-011	1	Rear-stop-indicator light, left
2SD 003 167-021	1	right
2SE 003 167-031	1	Rear-stop-indicator light, with illumination for 520 x 120 mm and 340 x 240 mm licence plates, for horizontal surface mounting, left
2SE 003 167-041	1	right
Spare parts/Accessories:		
9EL 147 747-001	1	Lens with screws
9GD 087 883-355	10	Gasket
9GP 003 995-801	1	External vibration dampers
9GP 003 995-801	1	Kit comprising: 2 each with M8 fixing screw
8GA 002 073-121	10	P21W bulb,
8GA 002 073-241	10	24V R10W bulb,
8GA 002 071-131	10	12V
8GA 002 071-251	10	24V

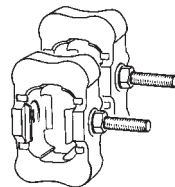

Signal lights

Rear

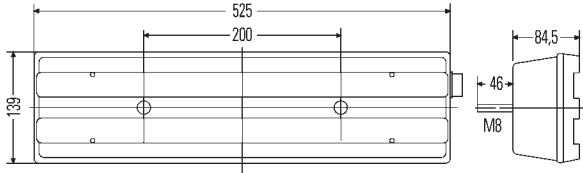
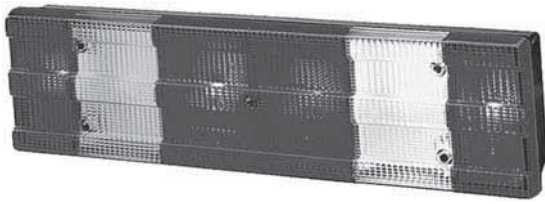

1	indicator	black/white
2	rear/licence plate/clearance	green/black
3	-	not used
4	rear fog	yellow/black/white
5	reverse	white/red
6	ground	brown
7	stop	black/red
8	-	not used

1	indicator	black/white
2	rear/licence plate/clearance/side-marker	green/black
3	-	not used
4	rear fog	yellow/black/white
5	reverse	white/red
6	ground	brown
7	stop	black/red
8	-	not used

1	ground	brown
2	rear/clearance/side-marker	green
3	reverse	black
4	indicator	red
5	stop	amber
6	rear fog	white
7	licence plate	green

2VD 007 500-411

1	ground	brown
2	rear/clearance/side-marker	green
3	reverse	black
4	indicator	red
5	stop	amber
6	-	not used
7	-	not used

2VP 007 500-421/-521

For horizontal surface mounting on towing vehicles
Also permissible for trailers in combination
with valid EC component homologation for lighting

Red rear, stop, rear fog, clearance light and reflector,
amber indicator light, white reverse light,
with illumination for 520 x 120 mm licence plates.
With side mounted amber reflector.

With vibration dampers and 24V bulbs.

When used in right-hand traffic, the licence plate window
in the right-hand light must be covered with the black
cover plate 9EL 134 301-011 (Pk. 1), order separately!

Black plastic body.

Two M8 fixing screws.

Part no.	Pk.	
2VD 007 500-091	1	Rear-reflector-stop-indicator-rear fog-reverse-clearance-licence plate light with side mounted amber reflector and 1200 mm long lead with 8-pole round plug connector, left
2VD 007 500-201	1	right
2VD 007 500-111	1	Rear-reflector-stop-indicator-rear fog-reverse-clearance-side-marker light with reflector-licence plate light with 1200 mm long lead and 8-pole round plug connector, left
2VD 007 500-221	1	right
2VD 007 500-411	1	Rear-reflector-stop-indicator-reverse-clearance-side-marker light with reflector, with 7-pole, amber centre plug connector and grommets on side, with rear fog light and licence plate light, left
2VP 007 500-421	1	without rear fog light and licence plate illumination, right
2VP 007 500-521	1	with backup alarm and electronics for reducing volume at night, left
Spare parts/Accessories:		
9EL 134 296-041	1	Lens with screws, left
9EL 134 296-051	1	right
9EL 146 838-001	2	Lens for side-marker light for -111/-221/-411/-421
9EL 134 301-001	4	Lens for licence plate illumination, for -091/-111/-201/-221/-411
9GT 074 132-001	10	Grommet for -091/-201/-111/-221
9EL 134 301-011	1	Cover plate, black
8GA 002 071-131	10	R10W bulb, 12V
8GA 002 071-251	10	24V P21W bulb,
8GA 002 073-121	10	12V
8GA 002 073-241	10	24V

For horizontal, without licence plate illumination also for vertical mounting on trailers, indicator light above

Red rear, stop and rear fog light, amber indicator light, white reverse light.
Black plastic body. Two M8 fixing screws.

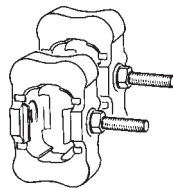
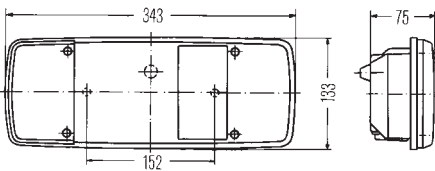
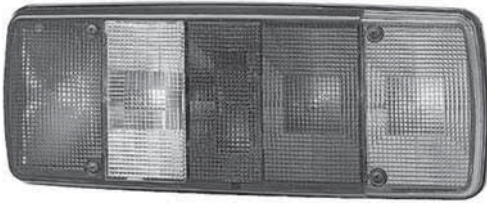

Part no.	Pk.	
2SK 003 567-331	1	Rear-stop-indicator-rear fog-reverse light, left
2SK 003 567-321	1	right
2SK 003 567-651	1	Rear-stop-indicator-rear fog-reverse light, two bulbs for rear light, left
2SK 003 567-661	1	right
2SL 003 567-311	1	Rear-stop-indicator-rear fog-reverse light, with licence plate illumination, left
9EL 122 772-001	2	Spare parts/Accessories: Lens with screws
9GP 003 995-801	1	External vibration dampers Kit comprising: 2 each with M8 fixing screw
8GA 002 071-131	10	R10W bulb, 12V
8GA 002 071-251	10	24V
8GA 002 073-121	10	P21W bulb, 12V
8GA 002 073-241	10	24V

For horizontal, without licence plate illumination also for vertical mounting on towing vehicles, indicator light above

Also permissible for trailers in combination with valid EC component homologation for lighting.
Red rear, stop, rear fog light and reflector, amber indicator light, white reverse light.
Black plastic body. Two M8 fixing screws.

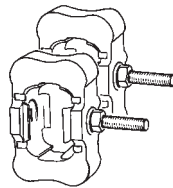
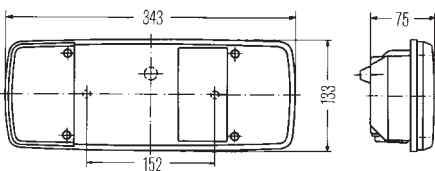
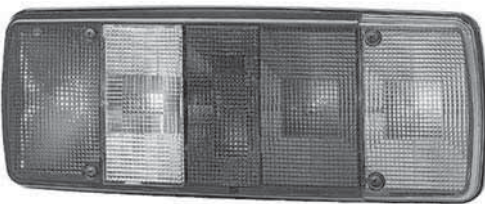

Part no.	Pk.	
2VP 003 567-111	1	Rear-reflector-stop-indicator-rear fog-reverse light, left
2VP 003 567-121	1	right
9EL 122 689-021	2	Spare parts/Accessories: Lens with screws
9GP 003 995-801	1	External vibration dampers Kit comprising: 2 each with M8 fixing screw
8GA 002 071-131	10	R10W bulb, 12V
8GA 002 071-251	10	24V
8GA 002 073-121	10	P21W bulb, 12V
8GA 002 073-241	10	24V

Signal lights

Rear



For horizontal surface mounting on towing vehicles

Red rear, stop, rear fog light and reflector, amber indicator light and white reverse light.

Black plastic body, without grommet.

Two M8 fixing screws.

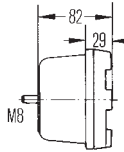
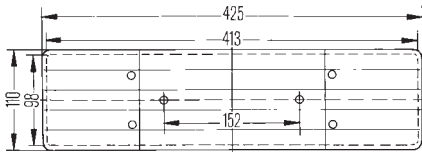
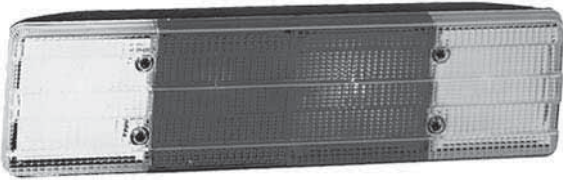

Part no.	Pk.	
2VB 004 887-011	1	Rear-reflector-stop-indicator-rear fog-lens plate light, left
2VA 004 887-031	1	Rear-reflector-stop-indicator-rear fog light, left
2VP 004 887-021	1	Rear-reflector-stop-indicator-reverse light, right
Spare parts/Accessories:		
9EL 131 420-001	1	Lens with screws, left
9EL 131 420-011	1	right
9GT 141 941-001	10	Grommet
8GA 002 073-121	10	P21W bulb, 12V
8GA 002 073-241	10	24V R10W bulb,
8GA 002 071-131	10	12V
8GA 002 071-251	10	24V

For horizontal surface mounting on towing vehicles

Red rear, stop, rear fog, clearance light and reflector, amber indicator and side-marker light with reflector, white reverse light, illumination for 520 x 120 mm licence plates.

Black plastic body.
Two M8 fixing screws.

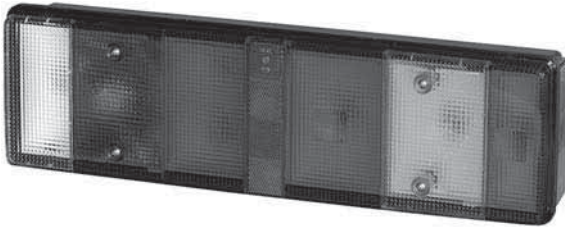

1	ground	white
2	rear/licence plate/clearance/side-marker	brown
3	reverse	amber
4	indicator	green
5	stop	red
6	rear fog	blue
7	-	not used

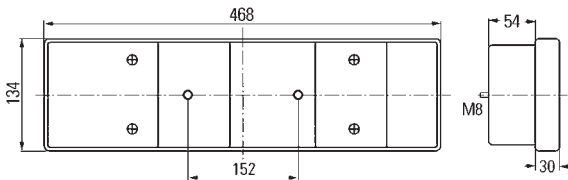

Part no.	Pk.	Description
2VD 008 204-231	1	Rear-reflector-stop-indicator-rear fog-reverse-clearance light and 7-pole, side-mounted AMP plug connector for RVI vehicles, with licence plate illumination, left
2VP 008 204-221	1	without licence plate illumination, right
2VD 008 204-211	1	Rear-reflector-stop-indicator-rear fog-reverse-clearance light without plug, however with PG fitting, and lead input, with licence plate illumination, left
2VP 008 204-201	1	without licence plate illumination, right
2VD 008 204-251	1	Rear-reflector-stop-indicator-rear fog-reverse-clearance light with 7-pole, side-mounted AMP plug connector for DAF and MAN vehicles, with licence plate illumination, left
2VP 008 204-241	1	without licence plate illumination, right
9EL 152 889-001	1	Spare parts/Accessories: Lens with screws
8GA 002 071-121	10	R5W bulb, 12V
8GA 002 071-241	10	R5W bulb, 24V
8GA 002 071-131	10	R10W bulb, 12V
8GA 002 071-251	10	R10W bulb, 24V
8GA 002 073-121	10	P21W bulb, 12V
8GA 002 073-241	10	P21W bulb, 24V

Signal lights

Rear

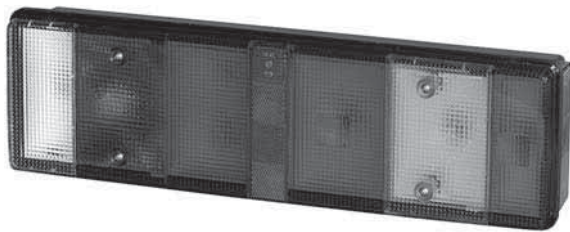

For horizontal surface mounting on towing vehicles

Red rear, stop, rear fog, clearance light and reflector, amber indicator light, white reverse light, illumination for 520 x 120 mm licence plates.
Black plastic body.
Two M8 fixing screws.

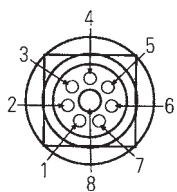

1	indicator	amber
2	rear/licence plate/clearance/side-marker	black
3	stop	red
4	rear fog	blue
5	reverse	grey
6	-	not used
7	-	not used
8	ground	white

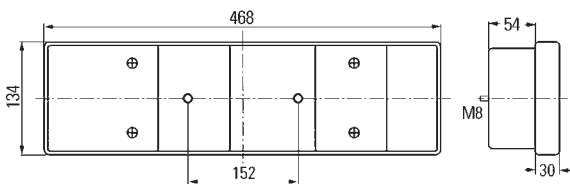
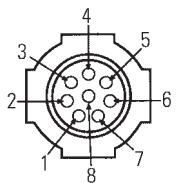

Part no.	Pk.	
2VD 008 204-051	1	Rear-reflector-stop-indicator-rear fog-reverse-clearance light with 8-pole AMP plug connector for MAN and Scania vehicles, with licence plate illumination, left and right
2VP 008 204-041	1	without licence plate illumination, left and right
2VD 008 204-071	1	with licence plate illumination, left
2VP 008 204-061	1	without licence plate illumination, left and right
2VD 008 204-131	1	Rear-reflector-stop-indicator-rear fog-reverse-clearance light with rear fog light and licence plate illumination, left
2VP 008 204-121	1	without rear fog light and licence plate illumination, left and right
2VD 008 204-171	1	Rear-reflector-stop-indicator-rear fog-reverse-clearance light with 8-pole special plug connector for DAF vehicles, with licence plate illumination, left
2VP 008 204-161	1	without licence plate illumination, right
9EL 152 889-001	1	Spare parts/Accessories: Lens with screws
8GA 002 071-121	10	R5W bulb, 12V
8GA 002 071-241	10	24V
8GA 002 073-121	10	P21W bulb, 12V
8GA 002 073-241	10	24V

For horizontal surface mounting on towing vehicles

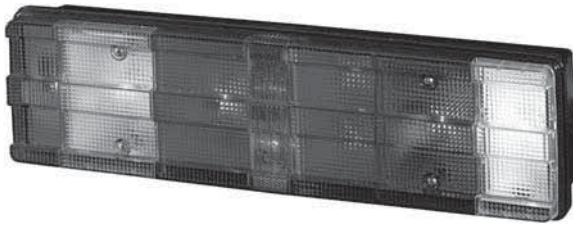

Red rear, stop, rear fog, clearance light and reflector, amber indicator and side-marker light with reflector, white reverse light, illumination for 520 x 120 mm licence plates. Lead entry through central body opening, without grommet. Black plastic body. Two M8 fixing screws.

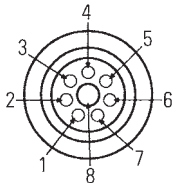
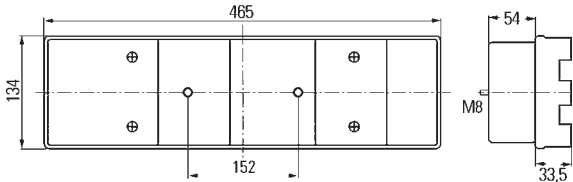

1	indicator	amber
2	rear/licence plate/clearance/side-marker	black/green-red/brown
3	stop	red
4	rear fog	blue
5	reverse	grey
6	-	not used
7	-	not used
8	ground	white

Part no.	Pk.	
2VD 008 204-111	1	Rear-reflector-stop-indicator-rear fog-reverse-clearance-side-marker light with reflector, for Mercedes-Benz vehicles, with rear fog light and licence plate illumination, left
2VP 008 204-101	1	without rear fog light and licence plate illumination, right
2VD 008 204-091	1	Rear-reflector-stop-indicator-rear fog-reverse-clearance-side-marker light with reflector, with 8-pole central plug connector for Mercedes-Benz vehicles, with licence plate illumination, left
2VP 008 204-081	1	without licence plate illumination, right
9EL 152 891-001	1	Spare parts/Accessories: Lens with screws
8GA 002 071-121	10	R5W bulb, 12V
8GA 002 071-241	10	24V
8GA 002 073-121	10	P21W bulb, 12V
8GA 002 073-241	10	24V

Signal lights

Rear



For horizontal surface mounting on towing vehicles

Red rear light, stop light, rear fog light, clearance light and reflector, amber indicator light and side marker light with reflector light, white reverse light,

with illumination for 520 x 120 mm licence plates.
Black plastic body.
Two M8 fixing screws.

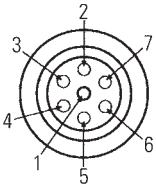
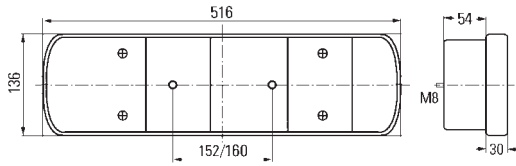

1	ground	white
2	indicator	green
3	stop	red
4	rear/licence plate/clearance/side-marker	brown
5	reverse	amber
6	rear fog	blue
7	-	not used



1	ground	white
2	indicator	green
3	stop	red
4	rear/licence plate/clearance/side-marker	brown
5	reverse	amber
6	rear fog	blue
7	-	not used



Part no.	Pk.	
2VD 008 205-011	1	Rear-reflector-stop-indicator-licence plate-rear fog-reversing-clearance-side marker light with reflector light, distance between screws 152 mm, for Volvo and Scania vehicles, left
2VD 008 205-021	1	right
2VD 008 205-051	1	Rear-reflector-stop-indicator-licence plate-rear fog-reversing-clearance-side marker light with reflector light, with 7-pole plug and distance between screws 160 mm, for Volvo and Scania vehicles, left
2VD 008 205-041	1	right
2VP 008 205-031	1	Rear-reflector-stop-indicator-rear fog-reversing-clearance-side marker light with reflector light, with 7-pole plug and distance between screws 160 mm, for Volvo and Scania vehicles, left and right
9EL 152 884-001	1	Spare parts/Accessories: Lens with screws
8GA 002 071-121	10	R5W bulb, 12V
8GA 002 071-241	10	24V
8GA 002 071-131	10	R10W bulb, 12V
8GA 002 071-251	10	24V
8GA 002 073-121	10	P21W bulb, 12V
8GA 002 073-241	10	24V

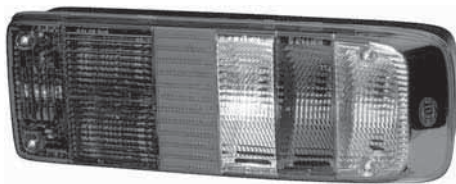

Red rear, reflector, stop and rear fog light, amber indicator- and side-marker light with reflector, reverse light white.

With 4 vibration dampers, 8-pole Schlemmer plug connector and 24V bulbs.

Two bulbs for rear light.

Black plastic body.
Two M8 fixing screws.

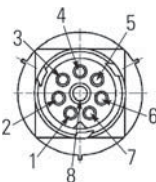
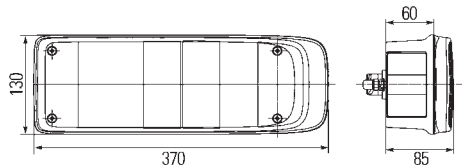

1	indicator	yellow/green
2	rear	brown
3	stop	red
4	rear fog	blue
5	reverse	pink
6	-	not used
7	-	not used
8	ground	white

Part no.	Pk.	
2VP 340 888-011	1	Rear-reflector-stop-indicator-rear fog-reverse light and side-marker light with reflector, left
2VP 340 888-001	1	right
9EL 340 829-041	1	Spare parts: Lens with screws
8GA 002 073-241	10	P21W bulb, 24V
8GA 002 071-251	10	R10W bulb, 24V
8GP 002 067-241	10	T4W bulb, 24V

For horizontal surface mounting on towing vehicles

Red rear, stop, rear fog, clearance light and reflector, amber indicator light, white reverse light, clear licence plate light, with illumination for 520 x 120 mm licence plates. With amber side-marker reflector.

When used in right-hand traffic, the licence plate window in the right-hand light must be covered with the black cover plate 9EL 134 301-011 (Pk. 1), order separately! Two M8 fixing screws.

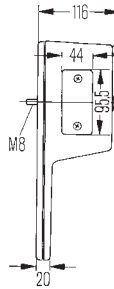
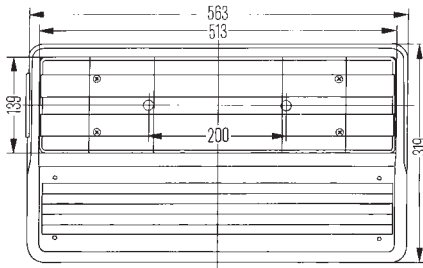
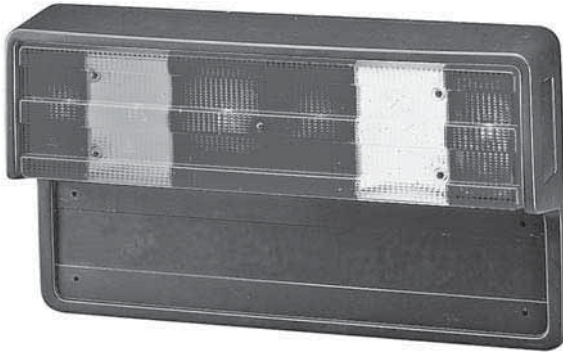

Part no.	Pk.	
2VD 005 300-551	1	Rear-reflector-stop-indicator-rear fog-licence plate-reverse-clearance-side-marker light with reflector, left
2VD 005 300-581	1	right
Spare parts/Accessories:		
Lens with screws,		
9EL 134 296-041	1	left
9EL 134 296-051	1	right
9EL 134 301-001	4	Lens for licence plate illumination
8RA 003 326-011	20	Reflectors
9EL 134 301-011	1	Cover plate, black
8GA 002 071-131	10	R10W bulb, 12V
8GA 002 071-251	10	24V
8GA 002 073-121	10	12V
8GA 002 073-241	10	24V

Signal lights

Rear



For horizontal surface mounting on towing vehicles

Rear light, reflector, stop light, rear fog light, clearance light and side-marker light with reflector red, indicator light (with amber bulb), reverse light and licence plate light white.
With 8-pole HDSCS-plug and DIN-plug.

Black plastic body.
Two M8 fixing screws.

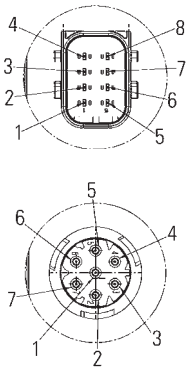
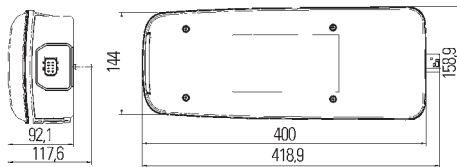

1	ground
2	-
3	-
4	rear fog
5	rear
6	reverse
7	indicator
8	stop
HDSCS plug	
1	ground
2	rear
3	reverse
4	indicator
5	stop
6	rear fog
7	-
DIN plug	

Part no.	Pk.	
2VD 011 511-031	1	Rear-reflector-stop-indicator-rear fog reverse-clearance-side-marker light with reflector with licence plate illumination and 24V bulbs, left
2VP 011 511-041	1	without licence plate illumination, with 24V bulbs, right
2VP 011 511-081	1	without licence plate illumination, with 24V bulbs and backup alarm, right
9EL 194 229-001	1	Spare parts/Accessories: Lens with screws
9DW 194 222-801	1	LED module for retrofitting the bulb version to a hybrid version
8GA 002 071-251	10	R10W bulb, 24V
8GA 002 073-241	10	P21W bulb, 24V
8GA 006 841-241	10	PY21W bulb, 24V
2VD 011 511-231	1	with licence plate illumination, 24V bulbs and 24V LEDs, left
2VP 011 511-241	1	without licence plate illumination, with 24V bulbs and 24V LEDs, right
2VP 011 511-281	1	without licence plate illumination, with 24V bulbs, 24V LEDs and backup alarm, right
9EL 194 229-001	1	Spare parts: Lens with screws
8GA 002 073-241	10	P21W bulb, 24V
8GA 006 841-241	10	PY21W bulb, 24V

For horizontal surface mounting on towing vehicles

Truck Full LED

In LED-technology, 24V. With Glowing-Body-technology.

Rear light with 12 red LEDs 2.8W,
 stop light with 18 red LEDs 2.2W,
 indicator light with 6 amber LEDs 4.2W,
 rear fog light with 8 red LEDs 2.5W,
 reverse light with 6 white LEDs 4.7W,
 side-marker light with with 5 red LEDs 2.8W,
 licence plate light with 4 white LEDs 1.7W.

With 7-pole DIN plug.

Black PC/ABS body.

Two M8 fixing screws.

Consumption at 24V:

rear light: 0.12A, stop light: 0.09A, indicator light: 0.18A,

rear fog light: 0.10A, reverse light: 0.20A,

side-marker-/clearance light: 0.12A, licence plate light: 0.07A.

With pulse for indicator failure check.

Type of protection: IP5K4K, IPX9K. See LED instruction 1.

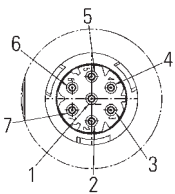
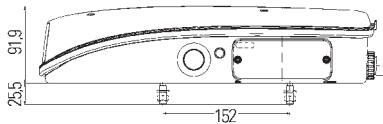
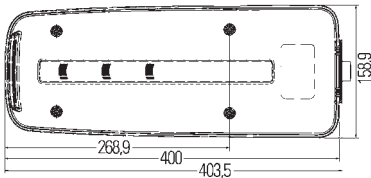
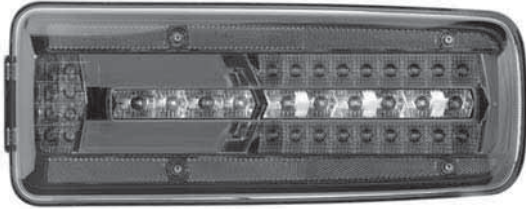

1	ground
2	rear
3	reverse
4	indicator
5	stop
6	rear fog
7	-



Part no.	Pk.	
2VD 012 381-011	1	Rear-reflector-stop-indicator-rear fog-reverse-clearance-side-marker light with reflector with licence plate illumination, left
2VP 012 381-021	1	without licence plate illumination, right
2VD 012 381-031	1	with licence plate illumination and 500 mm long lead, left
2VP 012 381-041	1	without licence plate illumination, with 500 mm long lead, right
2VP 012 381-051	1	Rear-reflector-stop-indicator-rear fog-reverse-clearance-side-marker light with reflector, left
2VP 012 381-061	1	with backup alarm, right
2VP 012 381-081	1	with backup alarm and 500 mm long lead, right
Spare parts/Accessories:		
9EL 208 551-011	1	Lens
5DS 009 602-001	1	LED-Indicator-control unit, 24V
4DW 009 492-011	1	LED flasher unit, 24V

For horizontal surface mounting on towing vehicles

Truck Full LED

In LED-technology, 24V. With Glowing-Body-technology.

Rear light with 12 red LEDs 2.8W,
 stop light with 18 red LEDs 2.2W,
 indicator light with 6 amber LEDs 4.2W,
 rear fog light with 8 red LEDs 2.5W,
 reverse light with 4 white LEDs 4.7W,
 side-marker-/clearance light with 5 red LEDs 2.8W,
 licence plate light with 4 white LEDs 1.7W.

With 7-pole DIN plug.

Black PC/ABS body.

Two M8 fixing screws.

Consumption at 24V:

rear light: 0.12A, stop light: 0.09A, indicator light: 0.18A,

rear fog light: 0.10A, reverse light: 0.20A,

side-marker-/clearance light: 0.12A, licence plate light: 0.07A.

With pulse for indicator failure check.

Type of protection: IP5K4K, IPX9K. See LED instruction 1.

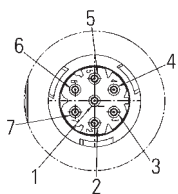
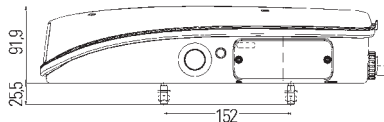
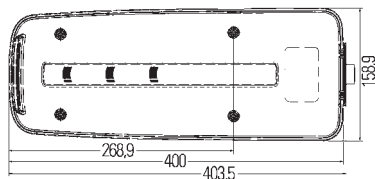

1	ground
2	rear
3	reverse
4	indicator
5	stop
6	rear fog
7	-



Part no.	Pk.	
2VD 012 381-311	1	Rear-reflector-stop-indicator-rear fog-reverse-clearance-side-marker light with reflector with licence plate illumination and side-mounted plug connector, left
2VP 012 381-321	1	without licence plate illumination, with side-mounted plug connector, right
2VP 012 381-341	1	without licence plate illumination, with side-mounted plug connector and backup alarm, right
2VD 012 381-351	1	with licence plate illumination and rear-mounted plug connector, left
2VP 012 381-361	1	without licence plate illumination, with rear-mounted plug connector, right
2VP 012 381-381	1	without licence plate illumination, with rear-mounted plug connector and backup alarm, right
Spare parts/Accessories:		
9EL 208 551-001	1	Lens
5DS 009 602-001	1	LED-Indicator-control unit, 24V
4DW 009 492-011	1	LED flasher unit, 24V

For horizontal surface mounting on towing vehicles

Truck Full LED

In LED-technology, 24V. With Glowing-Body-technology.

Rear light with 12 red LEDs 2.8W,
 stop light with 18 red LEDs 2.2W,
 indicator light with 6 amber LEDs 4.2W,
 rear fog light with 8 red LEDs 2.5W,
 reverse light with 4 white LEDs 4.7W,
 side-marker-/clearance light with 5 red LEDs 2.8W,
 licence plate light with 4 white LEDs 1.7W.

With 8-pole HDSCS plug.

Black PC/ABS body.

Two M8 fixing screws.

Consumption at 24V:

rear light: 0.12A, stop light: 0.09A, indicator light: 0.18A,

rear fog light: 0.10A, reverse light: 0.20A,

side-marker-/clearance light: 0.12A, licence plate light: 0.07A.

With pulse for indicator failure check.

Type of protection: IP5K4K, IPX9K. See LED instruction 1.

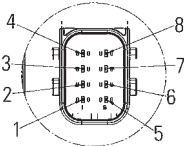
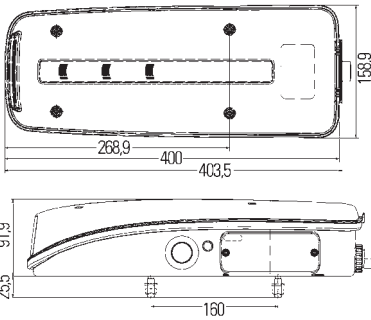
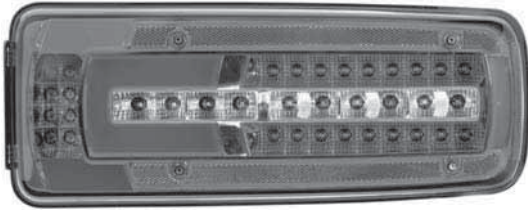

1	ground
2	-
3	-
4	rear fog
5	S
6	reverse
7	indicator
8	stop



Part no.	Pk.	
2VD 012 381-211	1	Rear-reflector-stop-indicator-rear fog-reverse-clearance-side-marker light with reflector with licence plate illumination and side-mounted plug connector, left
2VP 012 381-221	1	without licence plate illumination, with side-mounted plug connector, right
2VP 012 381-241	1	without licence plate illumination, with side-mounted plug connector and backup alarm, right
2VD 012 381-251	1	with licence plate illumination and rear-mounted plug connector, left
2VD 012 381-261	1	without licence plate illumination, with rear-mounted plug connector, right
2VD 012 381-281	1	without licence plate illumination, with rear-mounted plug connector and back alarm, right
Spare parts/Accessories:		
9EL 208 551-001	1	Lens
5DS 009 602-001	1	LED-Indicator-control unit, 24V
4DW 009 492-011	1	LED flasher unit, 24V

Signal lights

Rear



For horizontal surface mounting on trailers

Red rear, reflector, stop and rear fog light, amber indicator and side-marker light with reflector, white reverse light, clear licence plate light.

Black plastic body.
Two M8 fixing screws.
With grommet.

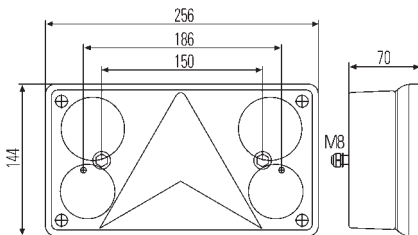
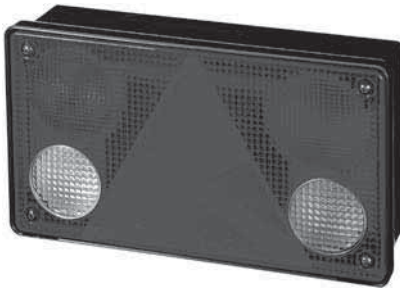

Part no.	Pk.	
2VP 340 400-151	1	Rear-reflector-stop-indicator-rear fog-reverse light, left
2VP 340 400-157	15	
2VP 340 400-141	1	right
2VP 340 400-147	15	
2VP 340 400-131	1	Rear-triangular reflector-stop-indicator-rear fog-reverse-side-marker light with reflector, left
2VP 340 400-121	1	
2VP 340 400-451	1	Rear-triangular reflector-stop-indicator-rear fog-reverse-side-marker light with reflector-licence plate light, for 520 x 120 mm and 340 x 240 mm licence plates, left
2VP 340 400-471	1	
Spare parts/Accessories:		
9EL 340 203-011	1	Lens with screws, left
9EL 340 203-001	1	right
8GA 002 073-121	10	P21W bulb, 12V
8GA 002 073-241	10	24V
8GA 002 078-121	10	P21/5W bulb, 12V
8GA 002 078-241	10	24V
8GA 002 078-011	10	24V (HD)

For horizontal or vertical surface mounting
on towing vehicles

Coluna

In LED-technology. Red rear, stop, rear fog light and rectangular reflector, white indicator and reverse light. Rear light with 12 red LEDs, stop and rear fog light with each red 6 LEDs, indicator light with 6 amber LEDs, reverse light with 6 white LEDs.

Rear light: 2.6W, stop light: 1.8W, indicator light: 3.3W, rear fog light: 2.2W, reverse light: 3.8W at 12V.

Rear light: 2.8W, stop light: 2.0W, indicator light: 3.8W, rear fog light: 2.4W, reverse light: 5.6W at 24V.

Black body and lens-retaining rim.

Consumption at 12V:

rear light: 0.2A, stop light: 0.15A, indicator light: 0.28A, rear fog light: 0.18A, reverse light: 0.32A.

Consumption at 24V:

rear light: 0.12A, stop light: 0.08A, indicator light: 0.16A, rear fog light: 0.10A, reverse light: 0.23A.

See LED instruction 1.

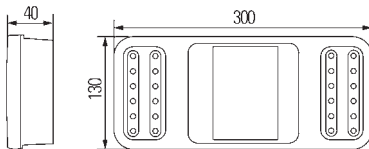

Part no.	Pk.	
		With 500 mm long lead with stripped ends. Two M8x 30 fixing screws.
2VP 345 900-401	1	Rear-rectangular reflector-stop-indicator-rear fog-reverse light with pulse for indicator failure check, 12V
2VP 345 900-201	1	with pulse for indicator failure check, 24V
2VP 345 900-411	1	without pulse for indicator failure check, 12V
2VP 345 900-211	1	without pulse for indicator failure check, 24V
		With 500 mm long lead with stripped ends. Fixing screws at the rear.
2VP 345 900-421	1	Rear-rectangular reflector-stop-indicator-rear fog-reverse light with pulse for indicator failure check, 12V
2VP 345 900-221	1	with pulse for indicator failure check, 24V
2VP 345 900-431	1	without pulse for indicator failure check, 12V
2VP 345 900-231	1	without pulse for indicator failure check, 24V

For horizontal or vertical surface mounting
on towing vehicles

Coluna

In LED-technology. Red rear, stop, rear fog light and triangular reflector, white indicator and reverse light. Rear light with 12 red LEDs, stop and rear fog light with each red 6 LEDs, indicator light with 6 amber LEDs, reverse light with 6 white LEDs.

Rear light: 2.6W, stop light: 1.8W, indicator light: 3.3W, rear fog light: 2.2W, reverse light: 3.8W at 12V.

Rear light: 2.8W, stop light: 2.0W, indicator light: 3.8W, rear fog light: 2.4W, reverse light: 5.6W at 24V.

Black body and lens-retaining rim.

Consumption at 12V:

rear light: 0.2A, stop light: 0.15A, indicator light: 0.28A, rear fog light: 0.18A, reverse light: 0.32A.

Consumption at 24V:

rear light: 0.12A, stop light: 0.08A, indicator light: 0.16A, rear fog light: 0.1A, reverse light: 0.23A.

See LED instruction 1.

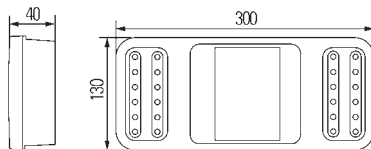

Part no.	Pk.	
		With 3000 mm long lead and 6.3 mm blade terminals. Two M8 x 30 fixing screws.
		Rear-rectangular reflector-stop-indicator-rear fog-reverse light with pulse for indicator failure check, 12V
2VP 345 900-441	1	
		with pulse for indicator failure check, 24V
2VP 345 900-241	1	
		without pulse for indicator failure check, 12V
2VP 345 900-451	1	
		without pulse for indicator failure check, 24V
2VP 345 900-251	1	
<hr/>		
		With 3000 mm long lead and 6.3 mm blade terminals. Fixing screws at the rear.
		Rear-rectangular reflector-stop-indicator-rear fog-reverse light with pulse for indicator failure check, 12V
2VP 345 900-461	1	
		with pulse for indicator failure check, 24V
2VP 345 900-261	1	
		without pulse for indicator failure check, 12V
2VP 345 900-471	1	
		without pulse for indicator failure check, 24V
2VP 345 900-271	1	

For horizontal surface mounting on trailers

Coluna

In LED-technology. Red rear, stop, rear fog light and triangular reflector, white indicator and reverse light. Rear light with 12 red LEDs, stop and rear fog light with each red 6 LEDs, indicator light with 6 amber LEDs, reverse light with 6 white LEDs.

Rear light: 2.6W, stop light: 1.8W, indicator light: 3.3W, rear fog light: 2.2W, reverse light: 3.8W at 12V.

Rear light: 2.8W, stop light: 2.0W, indicator light: 3.8W, rear fog light: 2.4W, reverse light: 5.6W at 24V.

Black body and lens-retaining rim.

Consumption at 12V:

rear light: 0.2A, stop light: 0.15A, indicator light: 0.28A,

rear fog light: 0.18A, reverse light: 0.32A.

Consumption at 24V:

rear light: 0.12A, stop light: 0.08A, indicator light: 0.16A,

rear fog light: 0.1A, reverse light: 0.23A.

See LED instruction 1.

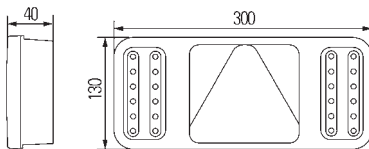

Part no.	Pk.	
		With 500 mm long lead with stripped ends. Fixing screws at the rear.
		Rear-triangular reflector-stop-indicator-rear fog-reverse light
2VP 345 900-331	1	without pulse for indicator failure check, left, 12V
2VP 345 900-341	1	without pulse for indicator failure check, right, 12V
2VP 345 900-131	1	with pulse for indicator failure check, left, 24V
2VP 345 900-141	1	with pulse for indicator failure check, right, 24V
<hr/>		
		With 1000 mm long lead and 7-pole EasyConn socket. Fixing screws at the rear.
		Rear-triangular reflector-stop-indicator-rear fog-reverse light
2VP 345 900-011	1	with pulse for indicator failure check, left, 24V
2VP 345 900-021	1	with pulse for indicator failure check, right, 24V
<hr/>		
		With 1000 mm long lead and 7-pole AMP plug connector. Fixing screws at the rear.
		Rear-triangular reflector-stop-indicator-rear fog-reverse light
2VP 345 900-091	1	with pulse for indicator failure check, left, 24V
2VP 345 900-101	1	with pulse for indicator failure check, right, 24V

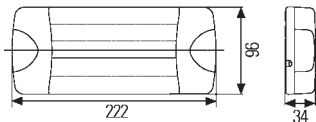

1	rear
2	stop
3	indicator
4	reverse
5	ground

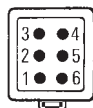

For horizontal surface mounting on trailers

DuraLED Combi

In LED-technology. With 30 LEDs.

With clear lens and metallic grey ends.

Rear light: 1.0W, stop light: 5.0W, indicator light: 4.0W, reverse light: 3.0W.

Black plastic body.

Two 6.2 mm dia. holes for fixing screws.

Consumption: 1.1A at 12V, 0.55A at 24V.

Voltage range: 12V - 24V.

Type of protection 2SK 980 603-503: IP6K6 and IP6K7.

Type of protection 2SK 980 615-001: IP6K7 and IP6K9K.

See LED instruction 1.

Part no.	Pk.	
2SK 980 603-503	1	Rear-stop-indicator-reverse light with 2500 mm long, potted lead with stripped ends
2SK 980 615-001	1	with 6-pole DEUTSCH plug connector

For horizontal surface mounting on towing vehicles and trailers

In LED-technology. With 18 LEDs 24V and polarity reversal protection.

With clear Grilamid lens and metallic grey ends.

Rear-stop light: 4.0W, indicator light: 3.0W, reverse light: 3.0W.

Black plastic body.

Two 6.2 mm dia. holes for fixing screws.

Consumption: 0.4A.

Type of protection: IP6K7, IP6K9K.

See LED instruction 1.

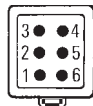
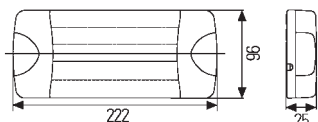

Part no.	Pk.	
2SK 980 613-501	1	Rear-stop-indicator-reverse light with 2500 mm long, potted lead with stripped ends
2SK 980 602-501	1	with 6-pole DEUTSCH plug connector

For horizontal surface mounting on towing vehicles and trailers

In LED-technology. With 40 LEDs and 2500 mm long lead with stripped ends.

Clear lens, red ends.

Rear light: 1.5W, stop light: 5.0W, indicator light: 3.0W.

Black plastic body.

Two 6.2 mm dia. holes for fixing screws.

Consumption: 0.92A at 12V, 0.46A at 24V.

Voltage range: 8V - 28V.

Type of protection: IP6K7, IP6K9K. See LED instruction 1.

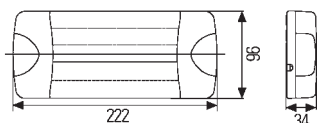
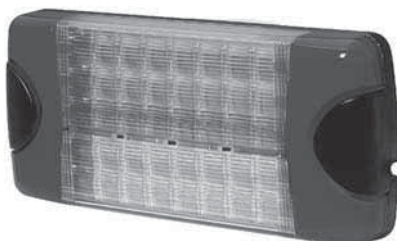

Part no.	Pk.	
2SD 959 050-401	1	Rear-stop-indicator light with pulse for indicator failure check

For horizontal surface mounting on towing vehicles and trailers

DuraLED Combi

In LED-technology. With 16 red LEDs and 2500 mm connecting lead with stripped ends. With red/amber Grilamid lens and metallic grey ends. Rear light: 1.0W, stop light: 4.0W, indicator light: 4.0W.

Black plastic body. Two 6.2 mm dia. holes for fixing screws. Consumption: 0.92A at 12V, 0.46A at 24V. Type of protection: IP6K9K. See LED instruction 1.

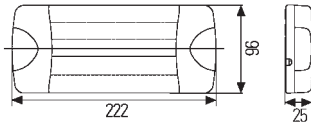
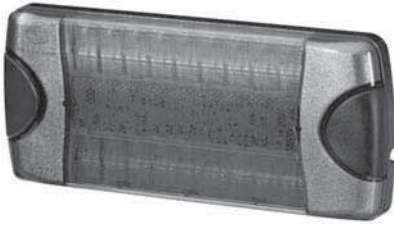

Part no.	Pk.	
2VA 980 710-061	1	Rear-reflector-stop-indicator light without pulse for indicator failure check, 12V / 24V
2VA 980 710-301	1	with pulse for indicator failure check, 24V

For horizontal or vertical surface mounting on towing vehicles and trailers

In LED-technology. With 30 LEDs. With clear Grilamid lens and red ends. Rear light: 1.0W, stop light: 5.0W, indicator light: 5.0W.

Black body. Two 6.2 mm dia. holes for fixing screws. Consumption: 0.92A at 12V, 0.46A at 24V. Voltage range: 12V - 24V. Type of protection: IP6K7, IP6K9K. See LED instruction 1.



1	rear
2	stop
3	indicator
4	indicator
5	ground
6	position

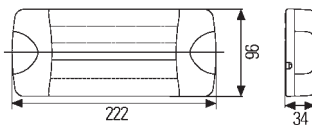
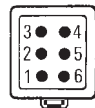

Part no.	Pk.	
2SD 980 602-211	1	Rear-stop-indicator light with pulse for indicator failure check and 6-pole DEUTSCH plug
2SD 980 613-211	1	with pulse for indicator failure check and 2500 mm connecting lead

For surface mounting on towing vehicles and trailers

DuraLED

In LED-technology. Clear lens. With 24 red LEDs and 2500 mm long lead with stripped ends. Rear light: 2.5W, stop light: 6.0W.

Black body. Voltage range: 9V - 33V. Consumption: rear light: 0.21A at 12V, 0.11A at 24V, stop light: 0.5A at 12V, 0.25A at 24V. Type of protection: IP6K6 and IP6K7. See LED instruction 2.

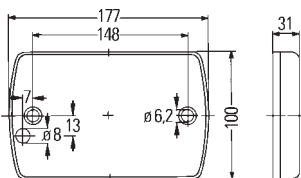

Part no.	Pk.	
2SB 980 606-201	1	Rear-stop light for horizontal mounting
2SB 980 606-701	1	for vertical mounting

For surface mounting on towing vehicles and trailers

DuraLED

**In LED-technology. Clear lens.
With 24 amber LEDs 4.0W and 2500 mm long lead
with stripped ends.**

Black body. Voltage range: 9V - 33V.
Consumption: 0.34A at 12V, 0.17A at 24V.
Type of protection: IP6K6, IP6K7.
See LED instruction 3.

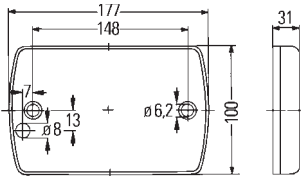

Part no.	Pk.	
2BA 980 607-201	1	Indicator light for horizontal mounting
2BA 980 607-701	1	for vertical mounting

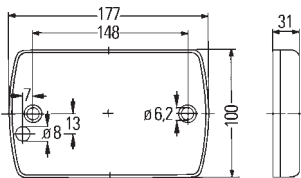

**In LED-technology. Clear lens.
With 24 white LEDs 4.0W and 2500 mm long lead
with stripped ends.**

Black body. Voltage range: 9V - 33V.
Consumption: 0.34A at 12V, 0.17A at 24V.
Type of protection: IP6K6, IP6K7.
See LED instruction 3.

Part no.	Pk.	
2ZR 980 605-201	1	Reverse light for horizontal mounting
2ZR 980 605-701	1	for vertical mounting

For surface mounting

In LED-technology. With 8 LEDs. Clear lens, red reflector.
Rear light: 1.0W, stop light: 2.0W, indicator light: 2.0W,
licence plate light: 1.0W.

Black frame with four holes 4.2 mm dia. and two holes 5.0 mm dia. for fixing screws.

Consumption:

Rear light: 0.08A at 12V, 0.04A at 24V,

stop light: 0.17A at 12V, 0.08A at 24V,

indicator light: 0.17A at 12V, 0.08A at 24V,

licence plate light: 0.08A at 12V, 0.04A at 24V.

EMC-resistant. Type of protection: IP6K9K and IP6K7.

See LED instruction 1.

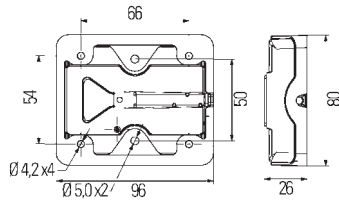

Part no.	Pk.	
		For horizontal or vertical surface mounting. With 500 mm long lead with stripped ends.
2VA 980 720-001	1	Rear-stop-indicator light, 12V/24V
2VA 980 720-007	18	
		For horizontal surface mounting, indicator light above, can be turned 180°. With 150 mm long lead and 4-pole DEUTSCH plug connector.
2VA 980 720-017	15	Rear-stop-indicator light, 12V/24V
		For horizontal surface mounting, indicator light above, can be turned 180°. With 500 mm long lead with stripped ends.
2VB 980 720-401	1	Rear-stop-indicator-licence plate light, 12V/24V
2VB 980 720-407	18	
		For horizontal surface mounting, indicator light below, can be turned 180°. With 500 mm long lead with stripped ends.
2VB 980 720-501	1	Rear-stop-indicator-licence plate light, 12V/24V
2VB 980 720-507	18	
		Accessories:
4JZ 177 846-007	24	Flasher unit, 9V - 33V
8JA 003 526-001	5	Socket, 9-pole

For surface mounting on towing vehicles and trailers

EuroLED

In LED-technology. With 1 Power-LED.

Firmly sealed with black base plate.

Electrical connection by means of a 2500 mm long lead.

Two 5.3 mm dia. holes for fixing screws.

Voltage range: 9V - 33V.

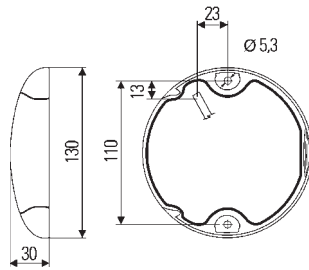

Part no.	Pk.	
		Red lens. With 1 red LED. Consumption: 0.21A at 12V, 0.10A at 24V. See LED instruction 2.
2SB 959 821-601	1	Tail-stop light, 2.5W
		Amber lens. With 1 amber LED. Consumption: 0.21A at 12V, 0.10A at 24V. See LED instruction 3.
2BA 959 822-601	1	Indicator light, 2.5W
		Clear lens. With 1 red LED. Consumption: 0.33A at 12V, 0.17 at 24V. See LED instruction 2.
2NE 959 821-201	1	Rear fog light, 4.0W
		White lens. With 1 white LED. Consumption: 0.21A at 12V, 0.10A at 24V. See LED instruction 2.
2ZR 959 820-601	1	Reverse light, 2.5W

For horizontal surface mounting on towing vehicles and trailers

Black plastic body.
Two M6 fixing screws. With grommet.

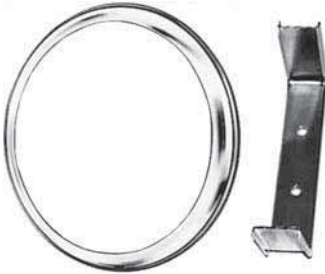
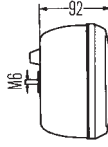
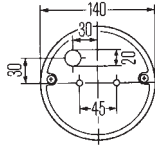

Part no.	Pk.	
		Red lens. Two lights can be fitted next to each other.
2NE 001 423-011	1	Rear fog light
		Spare parts/Accessories:
9EL 101 353-001	5	Lens with screws
8GA 002 073-121	10	12V P21W bulb,
8GA 002 073-241	10	24V
		Clear lens.
2ZR 001 423-001	1	Reverse light
		Spare parts/Accessories:
9ES 106 588-001	1	Lens
8GA 002 073-121	10	12V P21W bulb,
8GA 002 073-241	10	24V
		Accessories:
9XD 997 909-801	1	Mounting frame for flush mounting

For surface mounting on towing vehicles and trailers

Red rear and stop light, amber indicator light, clear licence plate light.
Two M6 fixing screws.

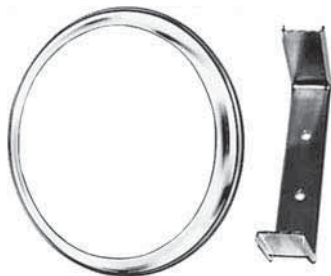
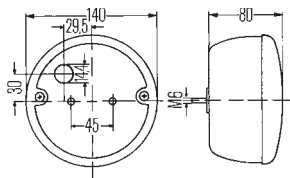

Part no.	Pk.	
2SD 001 685-211	1	Rear-stop-indicator light with grommet, without vibration damping and bulbs
2SD 001 685-231	1	Rear-stop-indicator light with vibration damping and grommet, without bulbs
2SE 001 685-201	1	Rear-stop-indicator-licence plate light, for 520 x 120 mm and 340 x 240 mm licence plates, with grommet, without vibration damping and bulbs
2SE 001 685-221	1	with vibration damping and grommet, without bulbs
9EL 113 324-001	2	Lens with screws and gasket
9FT 998 007-011	5	Bulb holder for -211/-201 R5W bulb,
8GA 002 071-121	10	12V
8GA 002 071-241	10	24V
8GA 002 073-121	10	P21W bulb, 12V
8GA 002 073-241	10	24V
9XD 997 909-801	1	Mounting frame for flush mounting, for -211/-231

For flush mounting

Without legal regulations for indicator failure check, with passive electronic. The indicator failure check in the vehicle demanded by law within the scope of ECE has to be ensured. The customer is responsible for this.

In LED-technology. With 42 LEDs.
Red rear and stop light, amber indicator light.
Rear light: 0.5W, stop light: 2.0W, indicator light: 3.0W.
Consumption: 0.23A at 24V.
Black plastic body.
Two M6 fixing screws.
See LED instruction 4.

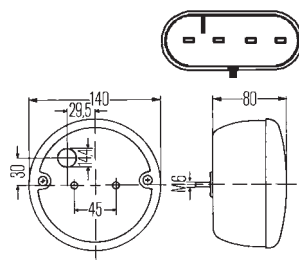

Part no.	Pk.	
2SD 001 685-347	20	Rear-stop-indicator light, 24V, with grommet and 500 mm long lead
2SD 340 685-051	1	with 2000 mm long lead and 4-pole AMP-Superseal plug connector
4JZ 177 846-007	24	Flasher unit, 9V - 33V, for -347
8JA 003 526-001	5	9-pole socket, for -347
5DS 009 552-031	1	LED indicator control unit, 24V, for -051
8KW 744 808-801	1	Plug-set for -051

**For flush mounting
in towing vehicles and trailers**

In LED-technology. With 2500 mm long lead.

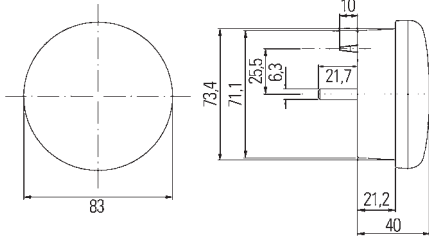

Part no.	Pk.	
		With 16 LEDs 24V. Red/amber lens. Rear light: 1.0W, stop light: 2.0W, indicator light: 2.0W. Consumption: 0.21A. See LED instruction 2.
2SD 959 010-401	1	Rear-stop-indicator light
2SD 959 010-407	10	
		With 12 LEDs 24V. Red lens. Rear light: 1.0W, stop light: 3.0W. Consumption: 0.13A. See LED instruction 2.
2SB 959 010-301	1	Rear-stop light
2SB 959 010-307	10	
		With 24 LEDs 9V-33V. Red lens. Rear light: 1.0W, stop light: 3.0W. Consumption: rear light: 0.08A at 12V, 0.04A at 24V, stop light: 0.25A at 12V, 0.125A at 24V. See LED instruction 2.
2SB 959 010-001	1	Rear-stop light
		With 12 LEDs 24V 3.0W. Amber lens. Consumption: 0.13A. See LED instruction 3.
2BA 959 011-301	1	Indicator light for rear mounting
2BA 959 011-307	10	
		With 25 LEDs 24V. Clear lens. Indicator light: 4.0W, position light: 1.0W. Consumption: 0.20A at 24V.
2BE 980 690-301	1	Indicator-position light
9GD 980 696-001	1	Accessories: Mounting ring

Signal lights

Rear



For flush mounting in towing vehicles and trailers

In LED-technology. With 2500 mm long lead.

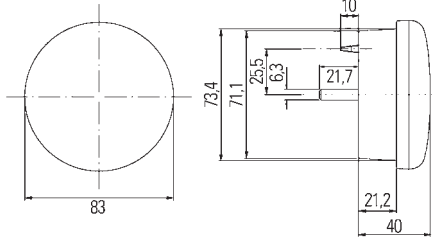

Part no.	Pk.	
		With 24 red LEDs 24V3.0W. Clear lens. Consumption: 0.25A at 12V, 0.13A at 24V. Voltage range: 9V - 33V. See LED instruction 2.
2NE 959 011-501	1	Rear fog light
2NE 959 011-507	10	
		With 24 white LEDs 24V4.0W. Clear lens. Consumption: 0.33A at 12V, 0.17A at 24V. Voltage range: 9V - 33V. See LED instruction 2.
2ZR 959 010-501	1	Reverse light
		With 24 white LEDs 24V4.0W. Clear lens. Consumption: 0.33A at 12V, 0.17A at 24V. Voltage range: 9V - 33V. See LED instruction 2.
2ZR 959 010-507	10	
		Accessories:
9GD 980 696-001	1	Mounting ring

**For flush or surface mounting
in towing vehicles and trailers**

In LED-technology. With 4 LEDs.

Lens red/amber/red with spare part lens clear.

Rear light: 2.0W, stop light: 3.0W, indicator light: 4.0W.

Voltage range: 9V - 32V.

Consumption: 0.75A at 12V, 0.38A at 24V.

Black plastic body.

Light may be installed 2 x per vehicle side.

Type of protection: IP6K9K.

See LED instruction 1.

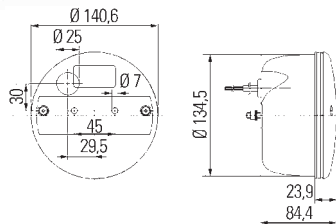
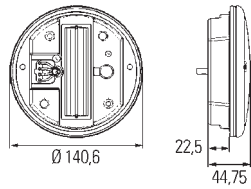
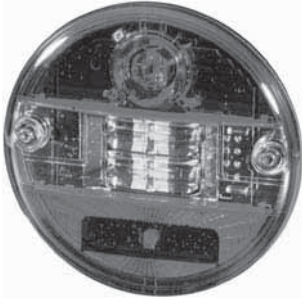

Part no.	Pk.	
2SD 344 100-001	1	Rear-stop-indicator light with two holes for fixing screws ST 4.8 and 500 mm long lead, for flush mounting
2SD 344 100-101	1	without lead, with two M6 x 20 fixing screws for surface mounting
9XD 997 909-801	1	Accessories: Chrome-type mounted frame with mounting bracket for flush mounting

Signal lights

Rear



For flush or surface mounting

In LED-technology. With 24 LEDs and 500 mm long lead.
Rear light: 1.0W, stop light: 1.5W, indicator light: 2.0W.
 Voltage range: 9V - 31V. Consumption: 0.4A at 12V, 0.2A at 24V.
 Black plastic body.
 With two M6 x 25 fixing screws.
 See LED instruction 1.

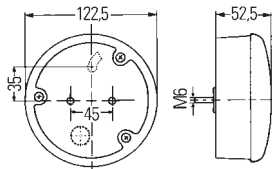

Part no.	Pk.	
2SD 344 200-001	1	Rear-stop-indicator light with pulse for indicator failure check and active thermal management, with clear lens
2SD 344 200-071	1	with red/clear lens
2SD 344 200-311	1	Rear-stop-indicator light without pulse for indicator failure check and passive thermal management, with red/clear lens
Accessories:		
4JZ 177 846-007	24	Flasher unit, 9V - 33V
8JA 003 526-001	5	Socket, 9-pole

In LED-technology. With 24 LEDs and 500 mm long lead.
Rear light: 1.0W, stop light: 3.0W.
 Voltage range: 9V - 31V. Consumption: 0.34A at 12V, 0.17A at 24V.
 Black plastic body.
 With two M6 x 25 fixing screws.
 Type of protection: IP6K9K.
 See LED instruction 2.

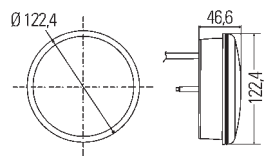
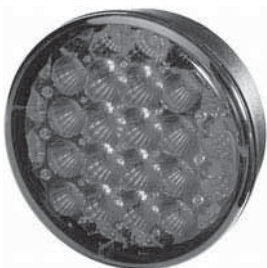

Part no.	Pk.	
2SB 344 200-027	24	Rear-stoplight with active thermal management with clear lens
2SB 344 200-081	1	with red lens

For surface mounting

In LED-technology. With 24 LEDs and 500 mm long lead with stripped ends.

Rear light: 1.0W, stop light: 5.0W.

Consumption at 24V: 0.25A.

Black plastic body.

With two M6 x 25 fixing screws.

Type of protection: IP6K9K.

See LED instruction 2.

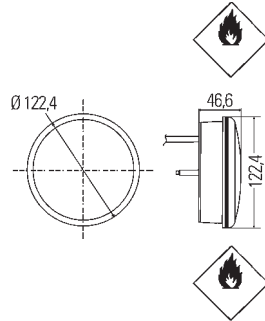

Part no.	Pk.	
2SB 344 200-321	1	Rear-stop light with passive thermal management, with clear lens
2SB 344 200-331	1	with red lens

For flush or surface mounting

In LED-technology. With 24 amber LEDs 3.0W and 500 mm long lead with stripped ends.

Voltage range: 9V - 31V. Consumption: 0.25A at 12V, 0.13A at 24V.

Black plastic body.

With two M6 x 25 fixing screws.

Type of protection: IP6K9K.

See LED instruction 3.

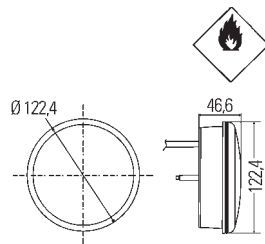

Part no.	Pk.	
2BA 344 200-037	24	Indicator light with clear lens, pulse for indicator failure check and active thermal management
4JZ 177 846-007	24	Accessories: Flasher unit, 9V - 33V
8JA 003 526-001	5	Socket, 9-pole

For surface mounting

In LED-technology. With 24 LEDs 2.0W and 500 mm long lead with stripped ends.

Consumption at 24V: 0.09A.

Black plastic body.

With two M6 x 25 fixing screws.

Type of protection: IP6K9K.

See LED instruction 4.

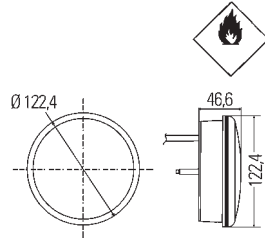

Part no.	Pk.	
2BA 344 200-341	1	Indicator light with clear lens, without pulse for indicator failure check and active thermal management
4JZ 177 846-007	24	Accessories: Flasher unit, 9V - 33V
8JA 003 526-001	5	Socket, 9-pole

For flush or surface mounting

In LED-technology. With 24 LEDs 2.0W and 500 mm long lead.

Voltage range: 9V - 32V. Consumption: 0.17A at 12V, 0.08A at 24V.

Black plastic body.

With two M6 x 25 fixing screws.

Lamp turned 180°.

See LED instruction 2.

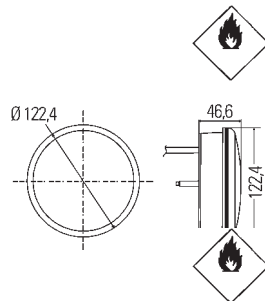

Part no.	Pk.	
2NE 344 200-061	1	Rear fog light with clear lens
2NE 344 200-091	1	with red lens

For flush or surface mounting

In LED-technology. With 9 red LEDs for rear fog light, 21 white LEDs for reverse light and 500 mm long lead with stripped ends. Clear lens.

Black plastic body.
With two M6 x 20 fixing screws.
Lamp turned 180°.
See LED instruction 2.

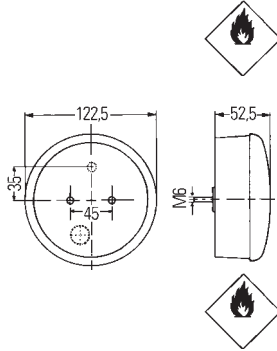

Part no.	Pk.	
2NR 344 169-441	1	Rear fog light: 2.0W, reverse light: 4.5W. Consumption: 0.5A.
		Rear fog-reverse light, 12V
2NR 344 169-461	1	Rear fog light: 2.8W, reverse light: 5.0W. Consumption: 0.33A. Rear fog-reverse light, 24V

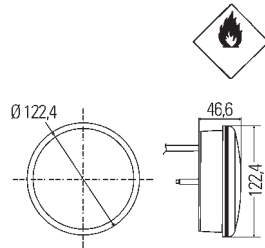

In LED-technology. With 24 LEDs 2.0W and 500 mm long lead.

Voltage range: 9V - 32V. Consumption: 0.17A at 12V, 0.08A at 24V.
Black plastic body.
With two M6 x 25 fixing screws.
Type of protection: IP6K9K.
See LED instruction 2.

Part no.	Pk.	
2ZR 344 200-051	1	Reverse light with clear lens

For horizontal or vertical surface mounting on towing vehicles and trailers

When attached horizontally, the optical field must point toward the outside of the vehicle.
 Can also be used as clearance light with reflector.
 In LED-technology. With 1 LED 24V1.2W.
 Red lens with reflector.

Consumption at 24V: 0.04A.
 Black body. Two holes for B4.2 fixing screws.
 Type de protection: IP6K9K. See LED instruction 2.

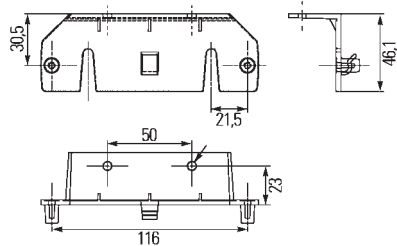
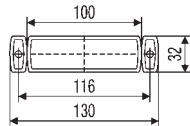

Part no.	Pk.	
2TM 008 645-951	1	Rear light with reflector with 500 mm long lead
2TM 008 645-941	1	with 5000 mm long lead
2TM 008 645-351	1	with 5000 mm long lead and 2-pole EasyConn socket
2TM 008 645-651	1	with 300 mm quick-link lead attachment incl. clamping piece for contacting a two-core flat lead
2TM 008 645-661	1	with 5000 mm quick-link lead attachment incl. clamping piece for contacting a two-core flat lead
Accessories:		
9GD 157 876-007	55	Gasket
8PE 008 932-001	1	Mounting pliers for quick-link lead attachment
8HG 340 489-001	1	Holder, angled back
8HG 340 413-001	1	Clip angle, rear
8KW 998 602-002	1	Clamping piece for quick-link lead attachment
8HG 160 409-002	10	Holder with two fixing screws

For horizontal surface mounting on towing vehicles

In LED-technology. With 2 red LEDs 24V1.0W.

Red lens with reflector.

Consumption: 0.04A at 24V.

Black base plate.

Two 5.5 mm dia. holes for fixing screws.

See LED instruction 2.

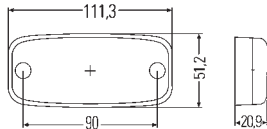

Part no.	Pk.	
2TM 345 600-317	1	Rear light with reflector with 500 mm long lead
9GD 341 063-007	20	Accessories: Gasket

Red lens with reflector.

With black rubber base.

Two ST4.2 x 16 fixing screws.

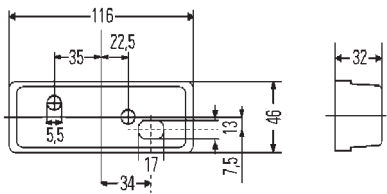

Part no.	Pk.	
2TM 003 748-011	4	Rear light with reflector
8GP 002 067-121	10	Accessories: T4W bulb, 12V
8GP 002 067-241	10	24V

Clearance lights

Rear



For side upright mounting on trailer

In LED-technology. Clear lens.
 With 1 white LED for position light,
 1 red LED for clearance light and
 2 amber LEDs for side marker light, 24V1.8W.
 Consumption at 24V: 0.08A.
 Black rubber body and rubber arm.
 Two 6.5 mm dia. holes for fixing screws.
 See LED instruction 2.

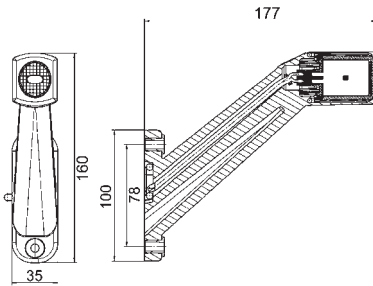

Part no.	Pk.	
2XS 011 744-011	1	Clearance light with 500 mm long lead and 2-pole EasyConn angular plug, left
2XS 011 744-021	1	
2XS 011 744-111	1	Clearance light with 500 mm long lead and 2-pole EasyConn socket, left
2XS 011 744-101	1	
2XS 011 744-031	1	Clearance light with 3000 mm long lead and two 6.3 mm blade terminals, left
2XS 011 744-041	1	
2XS 011 744-211	1	Clearance light with 800 mm long lead and 2-pole AMP Superseal plug connector, left
2XS 011 744-201	1	
2XS 011 744-051	1	Clearance light with 2000 mm long lead and 2-pole AMP Superseal plug connector, left
2XS 011 744-061	1	
2XS 011 744-071	1	Clearance light with 500 mm long lead and quick-link lead attachment, left
2XS 011 744-081	1	
2XS 011 744-191	1	Clearance light with 1000 mm long lead and quick-link incl. clamping piece, left
2XS 011 744-181	1	
2XS 011 744-171	1	Clearance light with 300 mm long lead and two blade terminal connectors 6.3 mm, left
2XS 011 744-161	1	
8KW 998 602-002	15	Accessories: Clamping piece for quick-link lead attachment
8PE 008 932-001	1	Mounting pliers for quick-link lead attachment

For side mounting on trailer

In LED-technology. Clear lens.
 With 1 white LED for position light,
 1 red LED for clearance light and
 2 amber LEDs for side marker light, 24V1.8W.
 Consumption at 24V: 0.08A.
 Black rubber body and rubber arm.
 Two 6.5 mm dia. holes for fixing screws.
 See LED instruction 2.

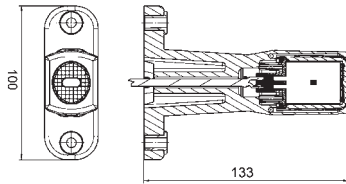
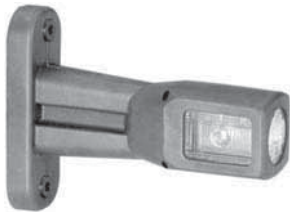

Part no.	Pk.	
2XS 011 768-001	1	Clearance light with 500 mm long lead and quick-link lead attachment, left and right
2XS 011 768-011	1	Clearance light with 500 mm long lead and 2-pole EasyConn socket 90°, left and right
2XS 011 768-021	1	Clearance light with 500 mm long lead and 2-pole EasyConn socket, left and right
2XS 011 768-031	1	Clearance light with 2000 mm long lead and AMP-Superseal plug connector, left and right
2XS 011 768-087	32	Clearance light with 150 mm long lead and 2-pole DEUTSCH plug connector, left and right
2XS 011 768-117	32	Clearance light with 350 mm long lead and 2-pole DEUTSCH plug connector, left and right
2XS 011 768-071	1	Clearance light with 2000 mm long lead and two 6.3 blade terminal connectors, left
2XS 011 768-061	1	Clearance light with 3000 mm long lead and two 6.3 blade terminal connectors, right
8KW 998 602-002	15	Accessories: Clamping piece for quick-link lead attachment
8PE 008 932-001	1	Mounting pliers for quick-link lead attachment

Clearance lights

Rear



For side mounting on trailer

In LED-technology. Clear lens.
 With 1 white LED for position light,
 1 red LED for clearance light and
 2 amber LEDs for side marker light, 24V1.8W.

Consumption at 24V: 0.08A.
 Black rubber body and rubber arm.
 Two 6.5 mm dia. holes for fixing screws.
 See LED instruction 2.

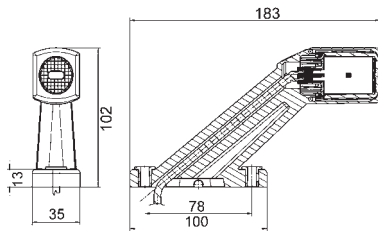

Part no.	Pk.	
2XS 011 769-011	1	Clearance light with 500 mm long lead and 2-pole EasyConn socket, left
2XS 011 769-021	1	right
2XS 011 769-051	1	Clearance light with 2000 mm long lead and AMP-Superseal plug connector, left
2XS 011 769-061	1	right
2XS 011 769-091	1	Clearance light with 670 mm long lead and quick-link lead attachment, left
2XS 011 769-101	1	right
8KW 998 602-002	15	Accessories: Clamping piece for quick-link lead attachment
8PE 008 932-001	1	Mounting pliers for quick-link lead attachment

For side mounting on trailers

In LED-technology. Clear lens.
 With 1 white LED for position light,
 1 red LED for clearance light and
 2 amber LEDs for side marker light, 24V1.8W.

Consumption at 24V: 0.05A.
 Black rubber body and rubber arm.
 See LED instruction 2.

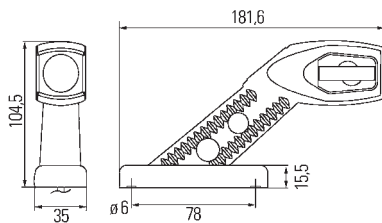

Part no.	Pk.	
2XS 340 448-011	1	Clearance light with 500 mm long lead and 2-pole EasyConn socket, left
2XS 340 448-001	1	right
8KW 998 602-002	15	Accessories: Clamping piece for quick-link lead attachment
8PE 008 932-001	1	Mounting pliers for quick-link lead attachment

For side mounting on trailer

In LED-technology. Clear lens.
 With 1 white LED for position light,
 1 red LED for clearance light and
 2 amber LEDs for side marker light, 24V1.8W.
 Consumption at 24V: 0.05A.
 Black rubber body and rubber arm.
 See LED instruction 2.

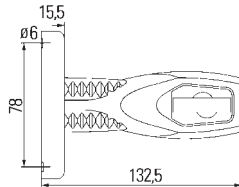

Part no.	Pk.	
2XS 340 447-001	1	Clearance light with 500 mm long lead and quick-link lead attachment, left and right
2XS 340 447-021	1	Clearance light with 500 mm long lead and 2-pole EasyConn socket, left and right
8KW 998 602-002	15	Accessories: Clamping piece for quick-link lead attachment
8PE 008 932-001	1	Mounting pliers for quick-link lead attachment

For side upright mounting on trailer

Lens for position light clear, for clearance light red and side-marker light amber.
 With 24V bulbs.
 Black rubber body and arm.
 Type of protection: IP5K4K.

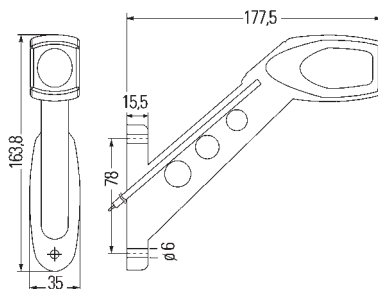

Part no.	Pk.	
2XS 340 827-131	1	Clearance light with 300 mm long lead and Quick-Link lead attachment, left
2XS 340 827-121	1	right
2XS 340 827-011	1	Clearance light with 500 mm long lead and 2-pole EasyConn socket, left
2XS 340 827-001	1	right
9EL 303 581-011	1	Spare parts: Lens 08/09-> T4W bulb,
8GP 002 067-241	10	24V

Clearance lights

Rear



For side mounting on trailer

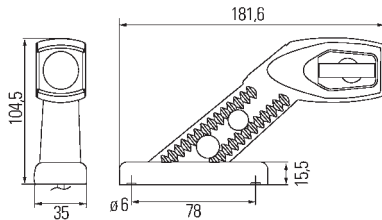

Lens for position light clear, for clearance light red and side-marker light amber.
With 24V bulbs.

Black rubber body and arm.
Type of protection: IP5K4K.

Part no.	Pk.	
2XS 302 241-071	1	Clearance light with 500 mm long lead and 2-pole EasyConn socket, left
2XS 302 241-081	1	
9EL 303 581-011	1	Spare parts: Lens T4W bulb, 24V
8GP 002 067-241	10	

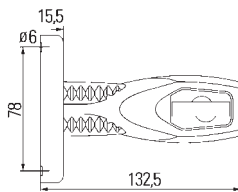

Lens for position light clear, for clearance light red and side-marker light amber.
With 24V bulbs.

Black rubber body and arm.
Type of protection: IP5K4K.

Part no.	Pk.	
2XS 302 240-031	1	Clearance light with 500 mm long lead and quick-link lead attachment, left and right
2XS 302 240-051	1	
9EL 303 581-011	1	Spare parts: Lens T4W bulb, 24V
8GP 002 067-241	10	

For side mounting on trailers

Front-facing part of lens frosted white, rear-facing part red, provided loose.

Black rubber body. Light is pre-wired.
Two 5.3 mm dia. holes for fixing screws.

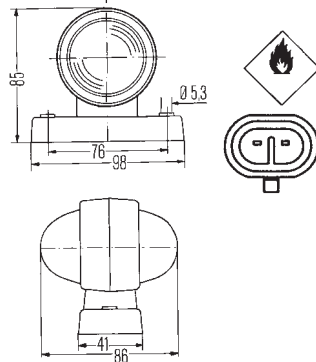

Part no.	Pk.	
2XS 955 031-001	2	Clearance light
2XS 955 031-017	100	with 150 mm long lead and 2-pole AMP Superseal plug connector
Spare parts/Accessories:		
9EL 950 315-061	5	red, for upright mounting
9EL 950 315-001	5	red, for pendant mounting
9EL 950 315-031	5	frosted white R5W bulb,
8GA 002 071-121	10	12V
8GA 002 071-241	10	24V
<hr/>		
2XS 950 071-031	2	Clearance light with rubber arm
Spare parts/Accessories:		
9EL 950 315-061	5	red
9EL 950 315-031	5	frosted white
Lead		
8KA 950 073-001	10	with plastic bulb holder
8KA 962 886-001	10	with metal bulb holder
R5W bulb,		
8GA 002 071-121	10	12V
8GA 002 071-241	10	24V
<hr/>		
2XS 955 232-001	2	Clearance light with straight rubber arm and 75 mm long lead
Spare parts/Accessories:		
9EL 950 315-061	5	red
9EL 950 315-031	5	frosted white
Lead		
8KA 950 073-001	10	with plastic bulb holder
8KA 962 886-001	10	with metal bulb holder
R5W bulb,		
8GA 002 071-121	10	12V
8GA 002 071-241	10	24V

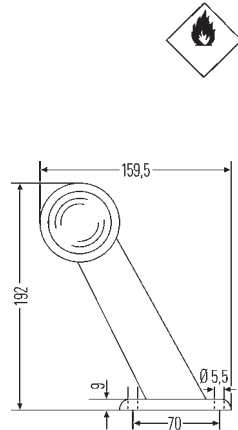
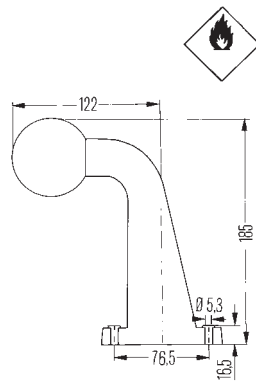

Clearance lights

Rear



For side mounting

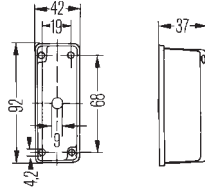

Part no.	Pk.	
2XS 005 020-001	10	For trailers, with two ST3.5 x 16-C fixing screws and grommet. Clearance light, front-facing part of lens clear, rear-facing part red
2XS 005 020-041	10	Clearance light, front-facing part of lens black, rear-facing part red
For towing vehicles, with flexible rubber support 55 x 42 mm and grommet.		
2XS 005 020-011	10	Clearance light, front-facing part of lens clear, rear-facing part red
2XS 005 020-091	10	Clearance light, front-facing part of lens black, rear-facing part red
For trailer, with grommet and rubber holder with fixing angle.		
2XS 005 020-021	10	Clearance light, front-facing part of lens clear, rear-facing part red
2XS 005 020-111	10	Clearance light, front-facing part of lens black, rear-facing part red
Spare parts/Accessories:		
9EL 132 215-001	2	lens with screws, front-facing part clear, rear-facing part red
9EL 132 215-011	2	lens with screws, front-facing part black, rear-facing part red
8GP 002 067-121	10	T4W bulb, 12V
8GP 002 067-241	10	T4W bulb, 24V

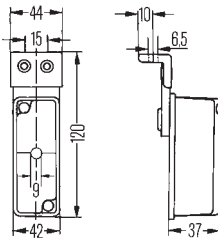
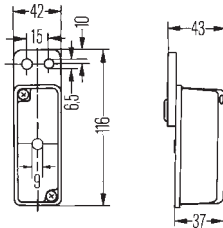

For side, horizontal or vertical surface mounting on trailers and semi-trailers with box body

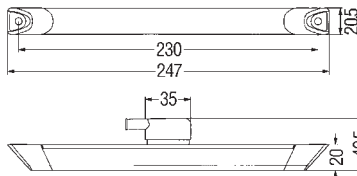

In LED-technology. With 2 red LEDs 24V1.2W and grommet. Clear lens. With LED light guide technology.
Consumption: 0.06A at 24V.
Grey plastic base plate and covers.
Two 5.4 mm dia. holes for fixing screws.
for fixing screws.

Part no.	Pk.	
2XS 008 078-001	1	Clearance light

For flush mounting above or below 520 x 120 mm (2 lights) licence plates

In LED-technology. With 4 LEDs 24V1.0W. Clear lens.

Consumption: 0.04A at 24V.

Black plastic rim.

Two holes for St3.9 fixing screws.

See LED instruction 2.

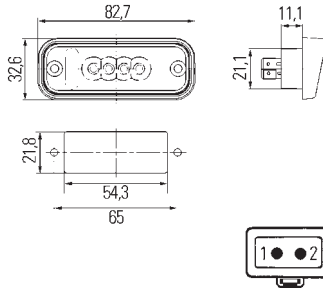

Part no.	Pk.	
2KA 010 278-011	1	Licence plate light with blade terminal contact 6.3 x 0.8 mm
2KA 010 278-607	30	with 1000 mm long lead, contacts firmly bonded
2KA 010 278-627	30	with 150 mm long lead and 2-pole DEUTSCH plug connector

For surface mounting to left or right of 520 x 120 mm licence plates (1 light)

In LED-technology. With 4 LEDs 24V1.0W. Clear lens.

Consumption: 0.04A at 24V.

Black plastic body.

Two M5 x 35 fixing screws.

See LED instruction 2.

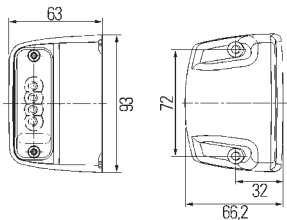

Part no.	Pk.	
2KA 010 278-021	1	Licence plate light with blade terminal contact 6.3 x 0.8 mm
2KA 010 278-031	1	with two-core 2000 mm long lead with blade receptacles 6.3 x 0.8mm
2KA 010 278-051	1	with two-core 500 mm long lead with 2-pin EasyConn central plug
2KA 010 278-071	1	with 1350 mm long lead and with 2-pole EasyConn angular plug

In LED-technology. Clear lens.

White light. With 2 white LEDs, 24V0.5W.

Consumption at 24V: 0.02A.

Body and base plate of black plastic.

Voltage range: 10V - 33V. See LED instruction 2.

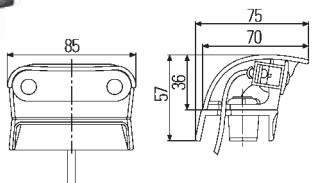

Part no.	Pk.	
2KA 959 640-607	8	Licence plate light with 2500 mm long lead
2KA 959 640-661	8	with 500 mm long lead and 2-pole EasyConn socket

Signal lights

Rear



For surface mounting to left or right of 520 x 120 mm licence plates (1 light)

In LED-technology. With 2 LEDs. Clear lens.
Power consumption: 12V0.3W, 24V0.6W.

Consumption: 0.03A.
 Black plastic body.
 Two M5 x 35 fixing screws.
 Voltage range: 9V - 33V.
 See LED instruction 2.

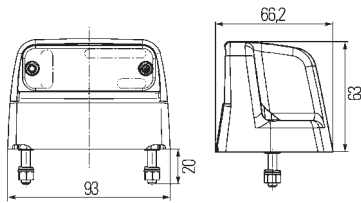

2KA 012 271-031
 2KA 012 271-037

Pk. 1
 36
Licence plate light with grey body and 2000 mm long lead with 6.3 mm blade terminals



2KA 012 271-041
 2KA 012 271-047

Pk. 1
 36
with grey body and 500 mm long lead with quick-link lead attachment



2KA 012 271-051
 2KA 012 271-057

Pk. 1
 36
with grey body and 500 mm long lead with 2-pole EasyConn socket



2KA 012 271-061
 2KA 012 271-067

Pk. 1
 36
with grey body and 1300 mm long lead with 2-pole AMP-Superseal plug connector



2KA 012 271-081
 2KA 012 271-087

Pk. 1
 36
with grey body and 2000 mm long lead with 2-pole AMP-Superseal plug connector



2KA 012 271-071
 2KA 012 271-077

Pk. 1
 36
with grey body and 1300 mm long lead with 2-pole EasyConn angular plug



2KA 012 271-237

Pk. 36
with white body and 2000 mm long lead with 6.3 mm blade terminals

2KA 012 271-277

Pk. 36
with white body and 1300 mm long lead with 2-pin EasyConn plug connector

For surface mounting to left and right of 340 x 240 mm and 520 x 120 mm licence plates

Clear lens. With 24V bulb.

Black plastic body.
Two M5 fixing screws.
Type of protection: IP5K9K.

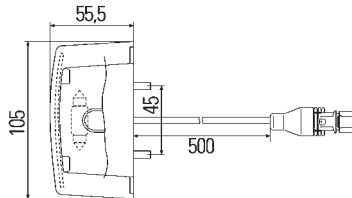

Part no.	Pk.	
2KA 340 828-001	2	Licence plate light with 500 mm long lead and 2-pole EasyConn socket
Spare parts/Accessories:		
8GM 002 092-121	10	C5W bulb, 12V
8GM 002 092-241	10	24V
8KW 998 602-002	15	Clamping piece for quick-link lead attachment
8PE 008 932-001	1	Mounting pliers for quick-link lead attachment

For surface mounting above 340 x 240 mm (1 light) and 520 x 120 mm (1 or 2 lights) licence plates or mounting to left and right of 340 x 240 mm and 520 x 120 mm licence plates

Clear lens.

Body and base plate of black plastic.
Two 4.5 mm dia. holes for fixing screws.

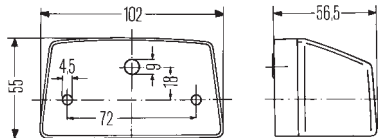

Part no.	Pk.	
2KA 003 389-061	2	Licence plate light
Accessories:		
9BG 121 587-031	2	Body with lens and screws
8GA 002 071-131	10	R10W bulb, 12V
8GA 002 071-251	10	24V
8GA 002 071-271	10	24V (HD)

Reflectors

Reflecting surface 95 sq. cm.
Reflector thickness 8.2 mm.

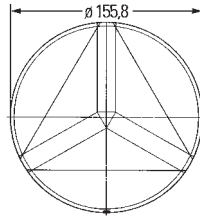
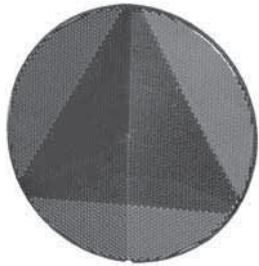
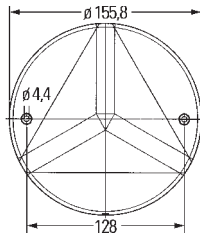
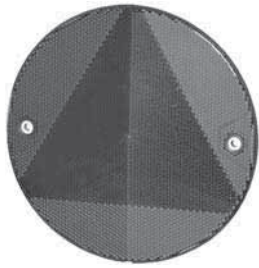

Part no.	Pk.	
8RA 343 220-017	30	Triangular reflector, red with two holes for fixing screws
8RA 343 220-007	30	self-adhesive

Reflecting surface 85 sq. cm.
With plastic base plate and two 6 mm dia. holes for fixing screws.

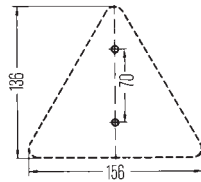

Part no.	Pk.	
8RA 002 020-001	25	Triangular reflector, red

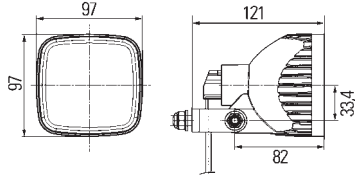

For upright mounting

Clear lens without optical pattern.
With 500 mm long lead and 24V bulb.
 Black plastic body.
 Pivot base with M10 fixing screws.
 Type of protection: IP5K9K.

Part no.	Pk.	
2ZR 996 179-701	1	Reverse light (ECO 21)
		Spare parts:
8GA 002 073-121	10	P21W bulb, 12V
8GA 002 073-241	10	24V

For upright or pendant mounting

With 24V bulb.
 Black fibre-glass reinforced plastic body.
 With M10 fixing screw and vibration damping.
 Type of protection: IP6K4K and IPX9K.

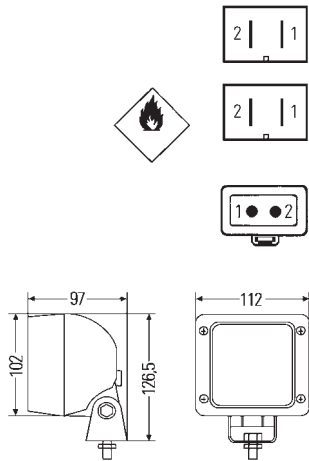

Part no.	Pk.	
2ZR 996 506-501	1	Reverse light (Ultra Beam FF) with 2-pole AMP plug connector and clear lens, in half without optical pattern
2ZR 997 506-621	1	
2ZR 997 506-691	1	Reverse light (Ultra Beam FF) with 2-pole DEUTSCH plug connector
		Spare parts/Accessories:
9GH 993 984-001	20	Cap for AMP plug connector
8JD 008 151-011	10	Socket for AMP plug connector
8KB 990 299-001	1	2000 mm long lead for AMP plug connector
8KW 701 235-033	100	Blade receptacles 6.3 mm
8GH 002 090-133	1	H3 bulb, 12V
8GH 002 090-251	1	24V

Combined hazard warning flasher and work lights

3003

Amber lens for hazard flasher, white for work light.
With 6V bulb and black mounting bracket.
Flash frequency > 60 flashes per minute.
Operating time with new alkaline batteries:
Hazard flasher approx. 40 hours, work light approx. 25 hours.
 The bulb and reflector pivot to the desired function when the switch above the lens is actuated.
 The light exit angle on the work light can be varied by moving the feet to three different positions.
 The light is stable up to a wind velocity of 9.
 Orange-coloured plastic body, feet black plastic with rubber nubs.
 5 x 1.5 mono cells (R20 or LR20) not included with light.
 With built-in tester for battery capacity.
 National type test for Germany.



Part no.	Pk.	
2XW 007 146-001	1	Hazard flasher light
		Spare parts:
8GP 002 096-061	10	F bulb, 6V

Combined hazard warning flasher and work lights

3003 Accu

Amber lens for hazard flasher, white for work light.

With 6V bulb and black mounting bracket.

Flash frequency > 60 flashes per minute.

Power supply: 6V, 3.0AH rechargeable battery.

Rated voltage 12V and 24V.

Power supply for charger circuit 10V to 32V.

Operating time with fully charged battery:

Hazard flasher approx. 40 hours, work light approx. 7 hours.

The bulb and reflector pivot to the desired function when the switch above the lens is actuated.

The light exit angle on the work light can be varied by moving the feet to three different positions.

The light is stable up to a wind velocity of 9.

Sulphur-yellow plastic body, feet black plastic with rubber nubs.

With maintenance-free, rechargeable lead gel battery and charging holder, for connecting to terminal 15 (ignition on) and terminal 31 (earth).

As soon as the light catches in the holder, the battery in the light starts being charged.

The charger operates with 12V and 24V systems.

Switch-over is automatic.

National type test for Germany.



Part no.	Pk.	
2XW 007 146-011	1	Hazard flasher light
Spare parts:		
8GP 002 096-061	10	F bulb, 6V

LED-indicator control unit

For 24V towing vehicles and trailers, with a 15-pole EasyConn plug on one as well as a 15-pole EasyConn socket on the other side, no independent power supply required. Type of protection: IP6K9K.



Part no.	Pk.	
5DS 009 552-001	1	LED-indicator control unit



	7N	7S
1	white	white/green
2	black	white/black
3	amber	pink
4	red	amber
5	green	white/blue
6	brown	white/red
7	white/brown	blue

8KA 340 818-001/011



Front distributor for articulated lorries

2 x 7-core front adapter lead with 15-pole EasyConn plug connector, 7-N socket DIN-ISO 1185 (lead 3 x 2.5 sq. mm / 4 x 1.5 sq. mm), 7-S socket DIN-ISO 3731 (lead 7 x 1.5 sq. mm). Suitable for main supply leads of series 8KA 340 815-..., 8KA 340 816-... and 8KA 340 817-...

Part no.	Pk.	
8KA 340 818-001	1	Front adapter lead, 1700 mm
8KA 340 818-011	1	600 mm
8KA 340 818-021	1	1700 mm



15-core front adapter lead (12 x 1.0 sq. mm / 3 x 2.5 sq. mm) with 15-pole EasyConn plug connector, 15-pole socket DIN-ISO 12098. Suitable for main supply leads of series 8KA 340 815-..., 8KA 340 816-... and 8KA 340 817-...

Part no.	Pk.	
8KA 340 842-011	1	Front adapter lead, 1700 mm
8KA 340 842-001	1	600 mm



Front adapter for trailers

GGVS-tested 2 x 7-core front adapter lead with 15-pole EasyConn plug connector, 7-N connector DIN-ISO 1185 (lead 3 x 2.5 sq. mm / 4 x 1.5 sq. mm), 7-S socket DIN-ISO 3731 (lead 7 x 1.5 sq. mm). Suitable for main supply leads of series 8KA 340 815-..., 8KA 340 816-... and 8KA 340 817-...

Part no.	Pk.	
8KA 340 841-001	1	Front adapter lead, 3500 mm
8KA 340 841-021	1	6000 mm



15-core front adapter lead (12 x 1.0 sq. mm / 3 x 2.5 sq. mm) with 15-pole EasyConn plug connector, 15-pole socket DIN-ISO 12098. Suitable for main supply leads of series 8KA 340 815-..., 8KA 340 816-... and 8KA 340 817-...

Part no.	Pk.	
8KA 340 843-001	1	Front adapter lead, 3500 mm
8KA 340 843-011	1	4500 mm
8KA 340 843-021	1	6000 mm



EasyConn flat leads

Supply lead (2 x 1.5 sq. mm) to connect side marker lights with reflex reflector and position lights per quick-link cabling or indentation clamping technology, with 2-pole EasyConn socket and heat-shrunk end cap.

Part no.	Pk.	
8KA 340 822-071	1	EasyConn flat lead, 6000 mm



Main supply leads

15-core main supply lead (12 x 1.0 sq. mm / 3 x 2.5 sq. mm), with two 15-pole EasyConn sockets, pre-fitted and extrusion-coated, without additional outlets.



Part no.	Pk.	
8KA 340 815-011	1	2-core main supply lead, 10000 mm
8KA 340 815-021	1	12000 mm
8KA 340 815-001	1	15500 mm



10-core main supply lead (8 x 1.0 sq. mm / 2 x 2.5 sq. mm), with two 15-pole EasyConn sockets, pre-fitted and extrusion-coated, without additional outlets.



Part no.	Pk.	
8KA 340 816-001	1	10-core main supply lead, 9000 mm
8KA 340 816-011	1	12000 mm
8KA 340 816-041	1	16500 mm



15-core main supply lead with outputs, (12 x 1.0 sq. mm / 3 x 2.5 sq. mm) with two 15-pole EasyConn sockets, pre-fitted and extrusion-coated.

1 - 4 outlets (in each case 300 mm long) with 2-pole EasyConn socket (for additional functions like, for example, reverse light or stop light) are possible. Upon request, the connector assignment of the 2-pole EasyConn socket can be specified individually. The coloured marking is provided according to function.



Part no.	Pk.	
8KA 340 817-011	1	2-core main supply lead, 15000 mm long, with two 300 mm long outputs with 2-pole EasyConn socket, 1 x black for tail light, left, 1 x brown for tail light, right

Rear adapter leads

Rear adapter lead with 15-pole EasyConn plug.

Suitable for main supply leads of series 8KA 340 815-..., 8KA 340 816-... and 8KA 340 817-...



Part no.	Pk.	
8KA 340 819-001	1	Rear adapter lead with two 7-core lead (6 x 1.0 sq. mm / 1 x 1.5 sq. mm), in each case 1300 mm long, starting on two 7-pole EasyConn socket for combination rear lights. As well as with each side three 2-pole EasyConn plugs, e.g. for licence plate, rubber arm lights and SMLR chains, linked by means of two leads (2 x 0.5 sq. mm) on each side, with a lead length of 500 mm between the individual male connector housings

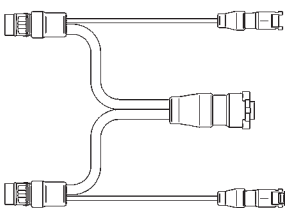

8KA 340 819-121	1	with two 7-core lead (6 x 1.0 sq. mm / 1 x 1.5 sq. mm), in each case 3000 mm long, starting on two 7-pole EasyConn socket for combination rear lights. As well as with each side a 2-pole EasyConn male connector housing, e.g. for SMLR chain, one of which is sealed tight with a cap, linked by a 3000 mm long flat lead (2 x 0.5 sq. mm) on each side, e.g. for clearance light with quick-link cabling
-----------------	---	---

Intermediate adapter leads

15-core adapter lead (12 x 1.0 sq. mm / 3 x 2.5 sq. mm), 500 mm long. With 15-pole EasyConn plug and 15-pole EasyConn socket. 1 - 4 outlets (in each case 300 mm long) with 2-pole EasyConn plug for additional functions (e.g. reverse light or stop light). Upon request, the connector assignment of the 2-pole EasyConn socket can be specified individually. The coloured marking is provided according to function.



Part no.	Pk.	
8KA 340 846-001	1	Intermediate adapter lead with two outlets in each case 300 mm long on the side of the 15-pole EasyConn socket, with in each case one 2-pole EasyConn plug, 1 x red for stop light, 1 x lilac for reverse light

Y adapter lead, 15-core (12 x 1.5 sq. mm, 3 x 2.5 sq. mm).



Part no.	Pk.	
8KA 340 864-011	1	Y adapter lead with one 15-pole EasyConn socket and two 500 mm long outputs with 15-pole EasyConn plugs

Y adapter lead 2-core (2 x 0.5 sq. mm).



Part no.	Pk.	
8KA 340 859-001	1	Y adapter lead with 2-pole EasyConn plug and two 150 mm long outlets with one 2-pole EasyConn plug as well as one 2-pole EasyConn socket
8KA 340 859-011	1	with 2-pole EasyConn plug and two 150 mm long outlets with in each case one 2-pole EasyConn socket



Lead set

14-core lead set FRONT AS (11 x 1.5 sq. mm, 3 x 2.5 sq. mm), with 24V plug (ISO 12098) for trailers with tarpaulin or box body. With 15-pole plug. Suitable for main supply lead 8KA 340 010-... as well as 15-pole plug (DIN-ISO 12098).



Part no.	Pk.	
8KA 340 031-001	1	Lead set, 3500 mm

Spirally-coiled lead

8-core adapter lead (7 x 1.0 sq. mm / 1 x 2.5 sq. mm) with 15-pole EasyConn plug and 15-pole EasyConn socket, pre-fitted and extrusion-coated. Can be used as an adapter lead between the main supply lead and the rear or front adapter lead.



Part no.	Pk.	
8KA 340 845-031	1	Spirally-coiled lead with 3000 mm working length

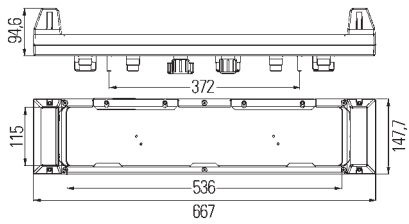

Combination distributor

For connecting all technical lighting functions 24V to the rear.
With licence plate light and mounting part for licence plate 520 x 120 mm.
With black cover at the front and back.

Part no.	Pk.	
8JE 340 060-001	1	Combination distributor with 6-pole socket for additional lighting functions, terminal 9 - 15 interior light, work light, rotating beacon
8JE 340 060-011	1	with two 6-pole sockets, 1x for additional illumination functions: terminal 9 - 15 interior light, work light, rotating beacon, 1x for special functions: steering axle, axle lift, ABS, starting aid
2KA 340 118-001	1	Spare parts: Licence plate light, 24V
8GM 002 092-241	10	C5W bulb, 24V

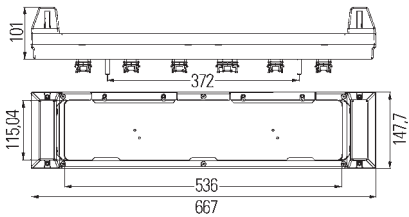

EasyConn combination distributor with integrated licence plate lighting for holding the licence plate.
With a 15-pole, five 7-pole and six 2-pole EasyConn connections for all technical lighting functions.
With separately protected lighting circuits.

Part no.	Pk.	
8JE 340 060-251	1	EasyConn combination distributor

Distributor boxes

Distributor box with lead glands as an alternative to 8JE 340 060-001.
Universal electrically contacting and can be mounted using flat receptacles 6.3 x 0.8 mm:
1 blade terminal strip with 14 terminals,
6 blade terminal strips with 6 terminals,
8 blade terminal strips with 4 terminals.
Provided with 12 lead glands:
10 x clamping area 3.5 - 10 mm, 2 x clamping area 9 - 18 mm.

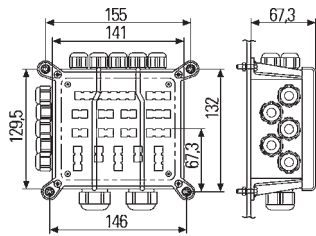

Part no.	Pk.	
8JE 340 151-001	1	Distributor box

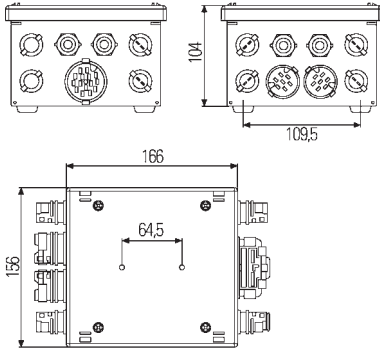
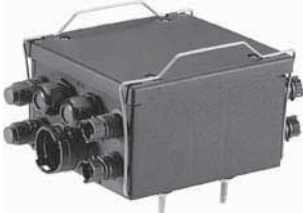

Distributor boxes

Distributor box with a 15-pole EasyConn connection (for the main supply), 2 x 7-pole EasyConn connections (for combination rear lights), 8 x 2-pole EasyConn connections (for example, SMLR, licence plate, clearance lights or special functions) as well as 4 x M20 lead glands, completely wired via pin block.

Part no.	Pk.	
8JE 340 867-011	1	Distributor box

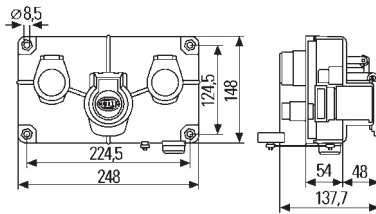

Combination distributor for front mounting

For connecting the technical lighting functions of the trailer. With 3 sockets on the front side: (24-N socket, 7-pole, as per DIN-ISO 1185 and 24-S socket, 7-pole, as per DIN-ISO 3731 as well as 15-pole socket as per DIN-ISO 12098) as input module for trailers and articulated lorries with or without flat beds. On the back with 1 x 15-pole bush to fit main supply lead 8KA 340 010-241 or adapter 8KA 340 010-251 with 2 x 2-pole bush for optimum connection of the side marker lights / clearance lights, protected by 2 blade-type fuses (2A).



Part no.	Pk.	
8JE 340 165-001	1	Combination distributor

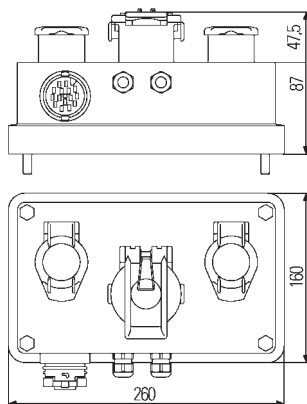

Front distributor for articulated lorries

Front distributor for direct connection to the EasyConn system, with three combined sockets: 1 x socket DIN-ISO 12098, 1 x 7-N socket DIN-ISO 1185 and 1 x 7-S socket DIN-ISO 3731, a 15-pole EasyConn connection (for the main supply) as well as two sealed M16 lead glands.



Part no.	Pk.	
8JE 340 898-001	1	Front distributor

Service sets

Service set for customer-specific cabling requirements (pre-fitted) for connecting to the EasyConn system. Including lead ties and respective number of contacts (blade terminals or blade receptacles).

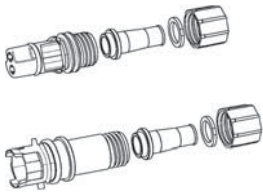

Part no.	Pk.	
9XX 340 879-001	1	Service set with 2-pole EasyConn socket, 19.5 mm dia.
9XX 340 882-001	1	24.5 mm dia.
8KL 340 009-001	1	Accessories: 2-core lead, FLRYY (2 x 1.0 sq. mm) 100 m
8KL 340 055-021	1	(2 x 0.5 sq. mm) 100 m
9XX 340 880-001	1	Service set with 7-pole EasyConn socket, 28.0 mm dia.
9XX 340 883-001	1	33.0 mm dia.
8KL 340 412-001	1	Accessories: 7-core lead, FLRYY (6 x 1.0 sq. mm / 1 x 1.5 mm) 50 m
8KL 340 054-001	1	(7 x 2.5 sq. mm) 50 m
9XX 340 881-001	1	Service set with 15-pole EasyConn socket, 39.0 mm dia.
9XX 340 884-001	1	44.0 mm dia.
8KL 340 059-001	1	Accessories: 15-core lead, FLRYY (12 x 1.0 sq. mm / 3 x 2.5 sq. mm) 25 m
9XX 340 984-001	1	Service set with 15-pole EasyConn socket, 44.0 mm dia.
9XX 340 981-001	1	49,2 mm dia.

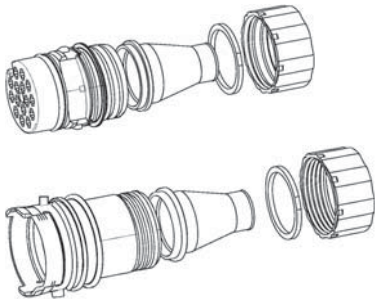
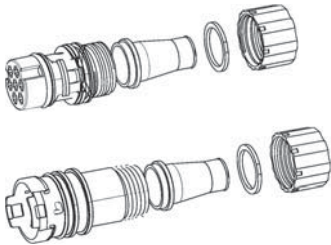

Connection sets

Connection set for 2-core flat lead or round lead. Fits combination distributor 8JE 340 060-... and for 2-core flat lead 8KL 340 050-...



Part no.	Pk.	
9XX 340 220-001	1	2-pole connection set

Connection set for 2-conductor flat lead or round lead for single-function lights.



Part no.	Pk.	
9XX 340 220-021	1	2-pole connection set



Connection sets

Connection set for 2-core round lead.
1 connection set for LED side marker light with reflex reflector 2PS 340 001-... and 1 connection set for combination distributor 8JE 340 060-...

Part no.	Pk.	
9XX 340 220-011	1	2-pole connection set



Connection set for 2-core round lead.
For connection of 10 LED side marker lights 2PS 340 001-...
Fits combination distributor 8JE 340 060-...

Part no.	Pk.	
9XX 340 220-801	1	2-pole connection set



Connection set for 6-core lead.
Fits combination distributor 8JE 340 060-..., as spare part for combination rear lights with 6-core lead and connector as well as for the distributor socket 8JE 340 061-...

Part no.	Pk.	
9XX 340 222-001	1	6-pole connection set



15-pole connection set for main power lead. Fits combination distributor 8JE 340 060-... and front distributor 8JE 340 165-001 and as spare part for the following leads: 8KA 340 010-..., 8KA 340 020-..., 8KA 340 021-..., 8KA 340 030-... and 8KA 340 031-...

Part no.	Pk.	
9XX 340 223-001	1	15-pole connection set



Locking cap

Locking cap for socket for a tight seal of unrequired EasyConn sockets.



Part no.	Pk.	
9HV 340 812-007	20	Locking cap for 2-pole EasyConn socket



Locking sets

Locking sets for male connector housing for tight seal of unrequired EasyConn plug with o-ring.



Part no.	Pk.	
9XX 340 870-007	20	Locking set for 2-pole EasyConn central plug
9XX 340 871-007	10	for 7-pole EasyConn male connector housing
9XX 340 872-007	5	for 15-pole EasyConn male connector housing



Lead set

Lead set with one 13-pole plug and two 5-pole outputs with two 5-pole bayonet angular plugs and outputs 3600 mm long for connection of rear-, position- and side-marker lights.

Part no.	Pk.	
8KA 998 240-071	1	Lead set, 6000 mm



Main supply lead

With 7-pole plug ISO 1724 for connection to the towing vehicle. On 7-pole plug with 400 mm protection tube. With 2 x 4/5-wire lead. 5-pole central plug for connection to the combination rear lights 2.. 998 232-... und 2.. 998 233-... with bayonet lock and double bush. Right-hand side with green central plug, left-hand side with yellow plug.

Part no.	Pk.	
8KA 998 230-001	1	Main supply lead, 4000 mm



Flat leads

2-wire flat lead for supplying various lights (side-marker light with reflector, clearance light, position light, position light with reflector, licence plate light and interior light.

Part no.	Pk.	
8KL 998 228-021	1	Ends protected by hot-shrink end caps. Flat lead, 9000 mm
8KL 340 050-001	1	Without hot-shrink end caps. Flat lead, 100 m drum
9GS 340 051-001	20	Accessories: Heat-shrink end cap



Round leads

2-wire round lead with quick-link-attachment incl. clamp for contacting a 2-wire flat lead. Free end for supply of diverse single-function lights.

Part no.	Pk.	
8KA 998 229-011	1	Round lead, 500 mm
8PE 008 932-001	1	Accessories: Mounting pliers for quick-link lead attachment

HELLA VALUEFIT

The HELLA VALUEFIT - proven quality at a good price. Under its HELLA VALUEFIT brand, HELLA offers a specific range of products that are exclusively tailored to the needs of customers in the independent aftermarket: these products offer reliable quality at a fair market price. Here, HELLA has combined its decades of technological expertise with unparalleled marketing skills. As a result, all these spare parts comply with the relevant technical specifications, are safe and reliable and facilitate more cost-effective repairs. The products in the HELLA VALUEFIT brand offer genuine added value – be smart: buy proven quality at a good price!

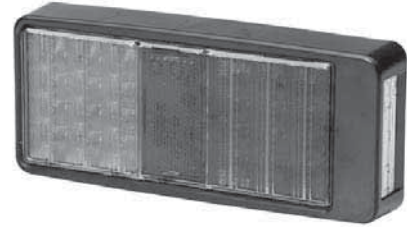

Rear	2.340.346
Light series	2.347-2.357
Licence plate lights	2.358
Clearance lights	2.359-2.362
Safety brake lights	2.362

For surface mounting

In LED-technology. With 33 LEDs and 500 mm long lead with stripped ends.

Rear light with 9 red LEDs, stop light with 12 red LEDs, indicator light with 12 amber LEDs.

Clear PC lens.

Rear light: 0.9W, stop light: 4.6W, indicator light: 3.2W at 12V.
Rear light: 1.3W, stop light: 5.7W, indicator light: 3.9W at 24V.

Black ABS body.

Two M8 fixing screws.

Consumption:

rear light: 0.08A at 12V, 0.05 at 24V,

stop light: 0.38A at 12V, 0.24A at 24V,

indicator light: 0.27A at 12V, 0.16A at 24V.

With polarity reversal protection.

Voltage range: 12V - 24V. Type of protection: IP67.

See LED instruction 1.

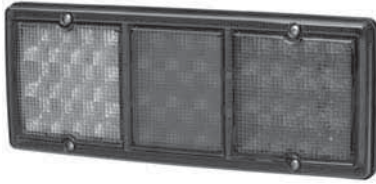

HELLA
VALUEFIT

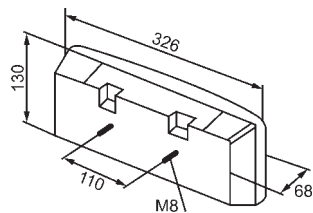

Part no.	Pk.	
2SD 357 024-001	1	Rear-stop-indicator light
Accessories:		
5DS 357 030-001	1	Indicator control unit, 12V
5DS 357 030-011	1	24V

For horizontal or vertical surface mounting

Red rear and stop light, amber indicator light.

PMMA lens.

Black ABS body.

Two M8 fixing screws.

With 6.3 mm blade terminals.



HELLA
VALUEFIT

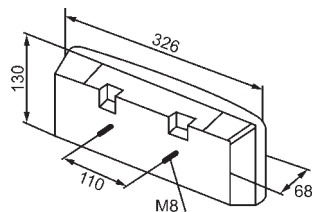

Part no.	Pk.	
2SD 357 031-001	1	Rear-stop-indicator light
Accessories:		
9EL 357 031-101	1	Lens
8GA 002 071-131	10	R10W bulb, 12V
8GA 002 071-251	10	24V
8GA 002 073-121	10	P21W bulb, 12V
8GA 002 073-241	10	24V

For horizontal or vertical surface mounting

In LED-technology. With 62 LEDs and 250 mm long lead with stripped ends.
Rear light with 8 red LEDs, stop light with 15 red LEDs, indicator light with 12 amber LEDs, rear fog light with 15 red LEDs, reverse light with 12 white LEDs.
Clear PMMA lens.

Rear light: 1.0W, stop light: 1.5W, indicator light: 1.5W, rear fog light: 2.5W, reverse light: 3.5W at 12V/24V.

Black ABS body.
 Two M6 fixing screws.

Consumption:
 rear light: 0.08A at 12V, 0.04A at 24V,
 stop light: 0.125A at 12V, 0.06A at 24V,
 indicator light: 0.125A at 12V, 0.06A at 24V,
 rear fog light: 0.21A at 12V, 0.10A at 24V,
 reverse light: 0.30A at 12V, 0.15A at 24V.

With polarity reversal protection.
 Voltage range: 10V - 30V. Type of protection: IP67.
 See LED instruction 1.



HELLA
VALUEFIT

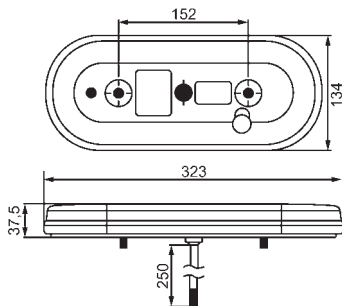

Part no.	Pk.	
2VP 357 017-011	1	Rear-reflector-stop-indicator-rear fog-reverse light, left
2VP 357 017-021	1	right
Accessories:		
5DS 537 030-001	1	Indicator control unit, 12V
5DS 537 030-101	1	24V

In LED-technology. With 32 LEDs, 250 mm long lead with stripped ends and control unit for indicator failure check.
Rear-stop light with 9 red LEDs, indicator light with 7 amber LEDs, rear fog light with 9 red LEDs, reverse light with 7 white LEDs.
Rear light: 1.0W, stop light: 3.0W, indicator light: 3.0W, rear fog light: 4.0W, reverse light: 3.0W at 12V/24V.

Black ABS body.
 Two M6 fixing screws.

Consumption:
 rear light: 0.08A at 12V, 0.04A at 24V,
 stop light: 0.25A at 12V, 0.125A at 24V,
 indicator light: 0.25A at 12V, 0.125A at 24V,
 rear fog light: 0.33A at 12V, 0.17A at 24V,
 reverse light: 0.25A at 12V, 0.125A at 24V.

With polarity reversal protection.
 Type of protection: IP67. See LED instruction 1.

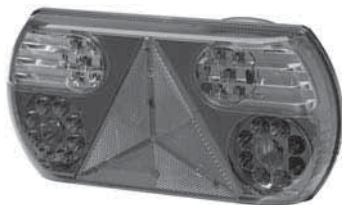

HELLA
VALUEFIT

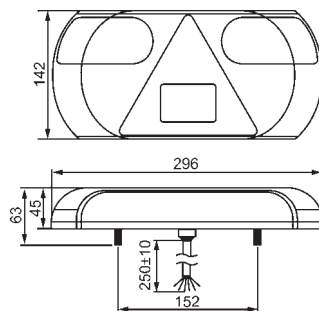

Part no.	Pk.	
2VP 357 016-011	1	Rear-triangular reflector-stop-indicator-rear fog-reverse light with pulse for indicator failure check, left, 12V
2VP 357 016-021	1	right, 12V
2VP 357 016-111	1	left, 24V
2VP 357 016-121	1	right, 24V

For surface mounting

In LED-technology. With 36 LEDs and 550 mm long lead with stripped ends.
Rear-stop light with 12 red LEDs, indicator light with 12 amber LEDs, reverse light with 12 white LEDs.

Clear PMMA lens.

Rear light: 0.5W, stop light: 3.0W, indicator light: 3.0W, reverse light: 2.5W.

Black ABS body.

Two M6 fixing screws.

Consumption:

rear light: 0.04A at 12V, 0.02A at 24V,
 stop light: 0.25A at 12V, 0.125A at 24V,
 indicator light: 0.25A at 12V, 0.125A at 24V,
 rear fog light: 0.21A at 12V, 0.10A at 24V,
 reverse light: 0.20A at 12V, 0.10A at 24V.

With polarity reversal protection.

Voltage range: 12V - 24V. Type of protection: IP67.

See LED instruction 1.

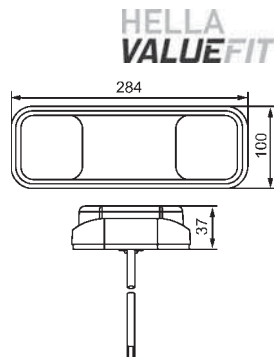

Part no.	Pk.	
2VP 357 018-001	1	Rear-reflector-stop-indicator-reverse light
Accessories:		
5DS 357 030-001	1	Indicator control unit, 12V
5DS 357 030-011	1	Indicator control unit, 24V

In LED-technology. With 40 LEDs and 500 mm long lead with stripped ends.

Rear-stop light with 12 red LEDs, indicator light with 12 amber LEDs, rear fog light with 16 red LEDs, reverse light with 16 white LEDs.

Clear PC lens.

Rear light: 0.5W, stop light: 3.6W, indicator light: 3.4W, rear fog light: 3.0W, reverse light: 1.8W at 12V.

Rear light: 0.7W, stop light: 4.1W, indicator light: 3.9W, rear fog light: 3.3W, reverse light: 2.1W at 24V.

Black ABS body.

Two M6 fixing screws.

Consumption:

rear light: 0.04A at 12V, 0.03A at 24V,
 stop light: 0.3A at 12V, 0.17A at 24V,
 indicator light: 0.28A at 12V, 0.16A at 24V,
 rear fog light: 0.25A at 12V, 0.14A at 24V,
 reverse light: 0.15A at 12V, 0.09A at 24V.

With polarity reversal protection.

Voltage range: 9V - 36V. Type of protection: IP67.

See LED instruction 1.

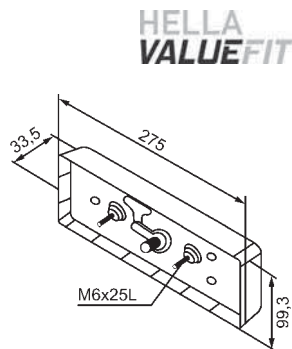
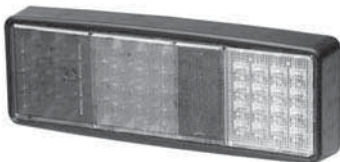

Part no.	Pk.	
2VP 357 019-001	1	Rear-reflector-stop-indicator-reverse light
2VP 357 019-011	1	Rear-reflector-stop-indicator-rear fog light
Accessories:		
5DS 357 030-001	1	Indicator control unit, 12V
5DS 357 030-011	1	Indicator control unit, 24V

For surface mounting

In LED-technology. With 27 LEDs and 500 mm long lead with stripped ends.

Rear-stop light with 12 red LEDs, indicator light with 12 amber LEDs, licence plate light with 3 white LEDs.

Clear PC lens.

Rear-licence plate light: 0.6W, stop light: 3.1W, indicator light: 3.2W at 12V.

Rear-licence plate light: 0.9W, stop light: 3.8W, indicator light: 3.2W at 24V.

Black ABS body.

Two M6 fixing screws.

Consumption:

rear licence plate light: 0.08A at 12V, 0.04 at 24V,

stop light: 0.26A at 12V, 0.16A at 24V,

indicator light: 0.27A at 12V, 0.13A at 24V.

With polarity reversal protection.

Voltage range: 9V - 36V. Type of protection: IP67.

See LED instruction 1.



HELLA
VALUEFIT

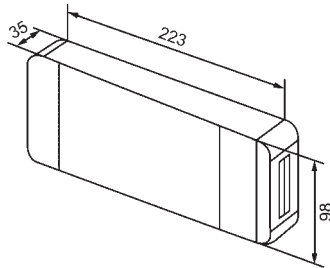

Part no.	Pk.	
2VA 357 020-011	1	Rear-reflector-stop-indicator light
2VB 357 020-001	1	Rear-reflector-stop-indicator-licence plate light
Accessories:		
5DS 357 030-001	1	Indicator control unit, 12V
5DS 357 030-011	1	Indicator control unit, 24V

For surface mounting

In LED-technology. With 300 mm long lead with stripped ends.
Clear PMMA lens.

Rear light: 0.5W, stop light: 2.0W, indicator light: 1.5W,
reverse light: 2.0W at 12V/24V.

Black ABS body.

Two ST4.2 fixing screws.

Consumption:

rear light: 0.04A at 12V, 0.02A at 24V,

stop light: 0.16A at 12V, 0.08A at 24V,

indicator light: 0.125A at 12V, 0.06A at 24V,

reverse light: 0.16A at 12V, 0.08A at 24V.

With polarity reversal protection.

Voltage range: 9V - 30V. Type of protection: IP67.

See LED instruction 1.



HELLA
VALUEFIT

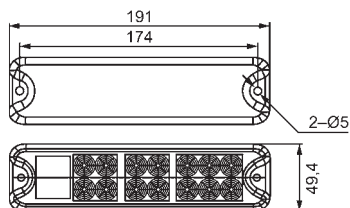

HELLA
VALUEFIT

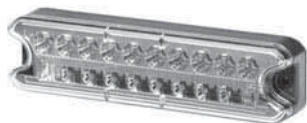

HELLA
VALUEFIT

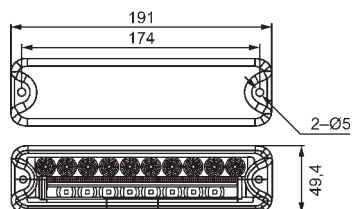

Part no.	Pk.	
2VA 357 021-001	1	With 18 LEDs, Rear-stop light with 8 red LEDs, indicator light with 10 amber LEDs. Rear-reflector-stop-indicator light
2VP 357 021-011	1	With 21 LEDs, rear-stop light with 6 red LEDs, indicator light with 6 amber LEDs, reverse light with 9 white LEDs. Rear-reflector-stop-indicator- reverse light
2VP 357 021-031	1	With 22 LEDs, rear-stop light with 7 red LEDs, indicator light with 7 amber LEDs, reverse light with 8 white LEDs. Rear-reflector-stop-indicator- reverse light, left
2VP 357 021-041	1	Rear-reflector-stop-indicator- reverse light, right
5DS 357 030-001	1	Accessories: Indicator control unit, 12V
5DS 357 030-011	1	24V

For surface mounting

In LED-technology. With 210 mm long lead with stripped ends.
Clear PMMA lens.

Rear light: 0.3W, stop light: 1.5W, indicator light behind: 1.6W,
indicator light front: 2.3W, position light: 0.8W.

Black ABS body.

Two M4 fixing screws.

Consumption:

rear light: 0.025A at 12V, 0.0125 at 24V,

stop light: 0.12A at 12V, 0.06A at 24V,

indicator light rear: 0.13A at 12V, 0.07A at 24V,

indicator light front: 0.20A at 12V, 0.10A at 24V,

position light: 0.06A at 12V, 0.03A at 24V.

With polarity reversal protection.

Voltage range: 12V - 24V. Type of protection: IP67.

See LED instruction 1, 2.

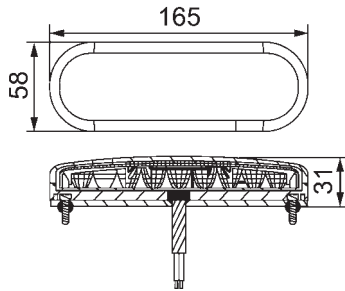

HELLA
VALUEFIT

Part no.	Pk.	
2SD 357 022-011	1	With 26 LEDs. Rear-stop light with 12 red LEDs, indicator light with 14 amber LEDs.
		Rear-stop-indicator light
2BE 357 022-001	1	With 26 LEDs, indicator light with 14 amber LEDs, position light with 12 white LEDs.
		Indicator-position light
5DS 357 030-001	1	Accessories: Indicator control unit, 12V
5DS 357 030-011	1	24V

HELLA
VALUEFIT

For horizontal or vertical surface mounting

Red rear and stop light, amber indicator light.

PMMA lens.

Black ABS body.

Two M6 fixing screws.

With 6.3 mm blade terminals.



HELLA
VALUEFIT

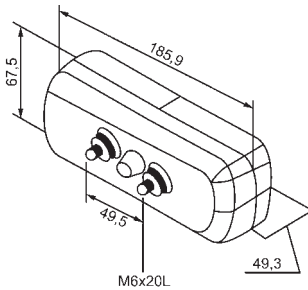

Part no.	Pk.	
2SD 357 033-001	1	Rear-stop-indicator light
9EL 357 033-111	1	Accessories: Lens
		P21/5W bulb,
8GD 002 078-121	10	12V
8GD 002 078-241	10	24V
8GA 002 073-121	10	P21W bulb,
		12V
8GA 002 073-241	10	24V

For surface mounting

In LED-technology. With 500 mm long lead with stripped ends.
Clear PC lens.

Rear light: 0.4W, stop light: 3.6W, indicator light: 4.0W at 12V,
rear light: 0.4W, stop light: 5.0W, indicator light: 5.8W at 24V.

Black ABS body.

Two M6 fixing screws.

Consumption:

rear light: 0.03A at 12V, 0.02 at 24V,

stop light: 0.35A at 12V, 0.21A at 24V,

indicator light: 0.33A at 12V, 0.24A at 24V.

With polarity reversal protection.

Voltage range: 9V - 36V. Type of protection: IP67.

See LED instruction 1.

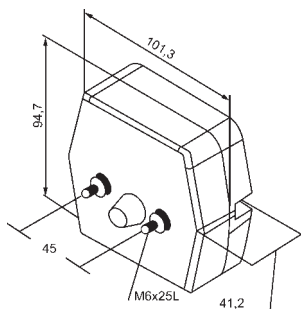

HELLA
VALUEFIT

Part no.	Pk.	
2VA 357 023-021	1	With 22 LEDs. Rear-stop light with 12 red LEDs, indicator light with 10 amber LEDs.
		Rear-reflector-stop-indicator light
2VB 357 023-011	1	With 25 LEDs, Rear-stop light with 12 red LEDs, indicator light with 10 amber LEDs, licence plate light with 3 white LEDs.
		Rear-reflector-stop-indicator- licence plate light
5DS 357 030-001	1	Accessories: Indicator control unit, 12V
5DS 357 030-011	1	24V

In LED-technology. With 500 mm lead with stripped ends.
Clear PC lens.

Indicator light: 4.0W at 12V, 5.8W at 24V,
position light: 0.4W at 12V, 0.4W at 24V.

Black ABS body.

Two M6 fixing screws.

Consumption:

indicator light: 0.34A at 12V, 0.24A at 24V,

position light: 0.03A at 12V, 0.02A at 24V.

With polarity reversal protection.

Voltage range: 9V - 36V. Type of protection: IP67.

See LED instruction 2.

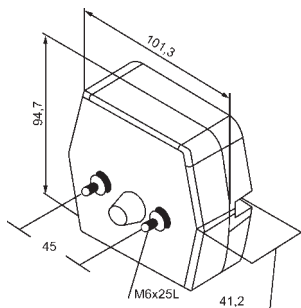

HELLA
VALUEFIT

Part no.	Pk.	
2BE 357 023-001	1	With 20 LEDs, indicator light with 18 amber LEDs, position light with 2 white LEDs.
		Indicator-position light
5DS 357 030-001	1	Accessories: Indicator control unit, 12V
5DS 357 030-011	1	24V

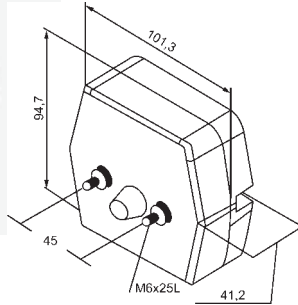

For horizontal surface mounting

PMMA lens.
 Black ABS body.
 Two M6 fixing screws.
 With 6.3 mm blade terminals.

HELLA
VALUEFIT

Part no.	Pk.	
2VB 357 032-031	1	<p>Red rear and stop light, amber indicator light, clear licence plate light.</p> <p>Rear-stop-indicator-licence plate light with magnetic attachment and triangular reflector</p>
2SE 357 032-021	1	<p>Rear-stop-indicator-licence plate light with magnetic attachment, without triangular reflector</p>
2SE 357 032-011	1	<p>Rear-stop-indicator-licence plate light</p> <p>Spare parts/Accessories:</p> <p>9EL 357 032-111 1 Lens</p> <p>8GD 002 078-121 10 P21/5W bulb, 12V</p> <p>8GD 002 078-241 10 24V</p> <p>8GA 002 071-131 10 R10W bulb, 12V</p> <p>8GA 002 071-251 10 24V</p>
2BE 357 032-001	1	<p>Amber indicator light, white position light.</p> <p>Indicator-position light</p> <p>Spare parts/Accessories:</p> <p>9EL 357 032-101 1 Lens</p> <p>8GA 002 073-121 10 P21W bulb, 12V</p> <p>8GA 002 073-241 10 24V</p> <p>8GA 002 071-121 10 R5W bulb, 12V</p> <p>8GA 002 071-241 10 24V</p>

HELLA
VALUEFIT



HELLA
VALUEFIT



HELLA
VALUEFIT



For horizontal or vertical surface mounting

In LED-technology. With 200 mm long lead with stripped ends.
Clear PMMA lens.

White ABS/PC body.

Attachment with ribs on the rubber body.

With polarity reversal protection.

Voltage range: 12V - 24V. Type of protection: IP67.

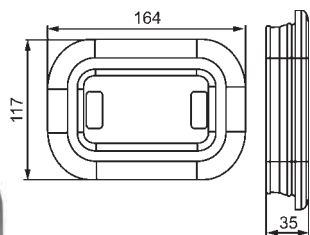

HELLA
VALUEFIT

Part no.	Pk.	
2SB 357 025-001	1	<p>With 13 red LEDs. Rear light: 0.4W, stop light: 3.0W. Consumption: rear light: 0.03A at 12V, 0.016A at 24V, stop light: 0.25A at 12V, 0.125A at 24V. See LED instruction 2.</p> <p>Rear-stop light</p>
2BA 357 025-011	1	<p>With 13 amber LEDs. Interior light: 3.0W. Consumption: 0.25A at 12V, 0.125A at 24V. See LED instruction 1.</p> <p>Interior light</p>
5DS 357 030-001	1	<p>Accessories: Indicator control unit, 12V</p>
5DS 357 030-011	1	
2ZR 357 025-021	1	<p>With 13 white LEDs. Reverse light: 3.0W. Consumption: 0.25A at 12V, 0.125A at 24V. See LED instruction 2.</p> <p>Reverse light</p>



HELLA
VALUEFIT



HELLA
VALUEFIT

For flush mounting

In LED-technology. With 24 LEDs and 260 mm long lead with stripped ends. PMMA lens.
 Black ABS body. Two M5 fixing screws.
 With polarity reversal protection.
 Type of protection: IP67.

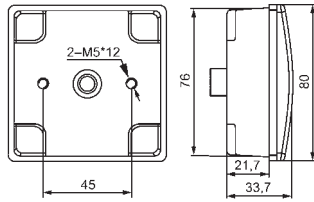

HELLA
VALUEFIT

Part no.	Pk.	
2SD 357 029-001	1	Rear light: 0.5W, stop light: 2.5W, indicator light: 2.5W. Consumption: rear light: 0.04A at 12V, 0.02A at 24V, stop light: 0.21A at 12V, 0.10A at 24V, indicator light: 0.21A at 12V, 0.10A at 24V. See LED instruction 1.
2SD 357 029-101	1	Rear-stop-indicator light, 12V
5DS 357 030-001	1	Accessories: Indicator control unit, 12V
5DS 357 030-011	1	24V
2SB 357 029-011	1	Rear light: 0.5W, stop light: 2.5W. Consumption: rear light: 0.04A at 12V, 0.02A at 24V, stop light: 0.21A at 12V, 0.10A at 24V. See LED instruction 2.
2SB 357 029-111	1	Rear-stop light, 12V
2SW 357 029-021	1	Rear light: 0.5W, indicator light: 2.5W. Consumption: rear light: 0.04A at 12V, 0.02A at 24V, indicator light: 0.21A at 12V, 0.10A at 24V. See LED instruction 1.
2SW 357 029-121	1	Rear-indicator light, 12V
5DS 357 030-001	1	Accessories: Indicator control unit, 12V
5DS 357 030-011	1	24V
2BA 357 029-031	1	Indicator light: 2.5W. Consumption: 0.21A at 12V, 0.10A at 24V. See LED instruction 3.
2BA 357 029-131	1	Indicator light, 12V
5DS 357 030-001	1	Accessories: Indicator control unit, 12V
5DS 357 030-011	1	24V



HELLA
VALUEFIT



HELLA
VALUEFIT



HELLA
VALUEFIT

For flush mounting

In LED-technology. With 24 LEDs and 260 mm long lead with stripped ends. PMMA lens.

Black ABS body. Two M5 fixing screws.

With polarity reversal protection.

Type of protection: IP67.

See LED instruction 2.

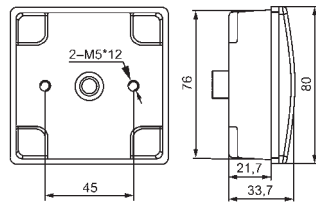

HELLA
VALUEFIT



HELLA
VALUEFIT



HELLA
VALUEFIT

Part no.	Pk.	
		Rear fog light: 2.5W. Consumption: 0.21A at 12V, 0.10A at 24V.
2NE 357 029-041	1	Rear fog light, 12V
2NE 357 029-141	1	24V
<hr/>		
		Reverse light: 2.0W. Consumption: 0.16A at 12V, 0.08A at 24V.
2ZR 357 029-051	1	Reverse light, 12V
2ZR 357 029-151	1	24V
<hr/>		
		Rear fog light: 2,5W, reverse light: 2,0W. Consumption: rear fog light: 0,21A at 12V, 0,10A at 24V, reverse light: 0,16A at 12V, 0,08A at 24V.
2NR 357 029-061	1	Rear fog-reverse light, 12V
2NR 357 029-161	1	24V

For surface mounting

In LED-technology.
With 500 mm long lead with stripped ends.
Clear PMMA lens with reflector.
 Black ABS body.
 Two ST4.2 fixing screws.
 With polarity reversal protection.
 Voltage range: 9V - 36V. Type of protection: IP67.
 See LED instruction 2.

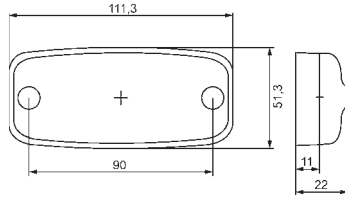

HELLA
VALUEFIT



HELLA
VALUEFIT



HELLA
VALUEFIT

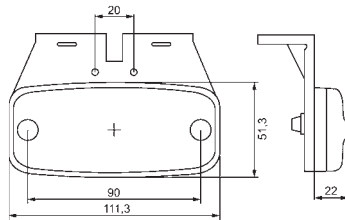

Part no.	Pk.	
2TM 357 008-021	1	With 3 red LEDs. Power consumption: 1.0W at 12V, 2.0W at 24V. Consumption: 0.08A. Rear light with reflector
		With 3 white LEDs. Power consumption: 1.2W at 12V, 2.5W at 24V. Consumption: 0.10A. Position light with reflector
2PS 357 008-001	1	With 3 amber LEDs. Power consumption: 1.0W at 12V, 2.0W at 24V. Consumption: 0.08A. Side-marker light with reflector without bracket
2PS 357 008-011	1	Side-marker light with reflector with bracket

For surface mounting

In LED-technology. With 150 mm long lead, 6.3 mm blade terminal contacts and insulating sleeves. Clear PMMA lens with reflector.

Consumption: 0.04A at 12V, 0.02A at 24V.
 Black ABS body. Two ST4.2 fixing screws.
 With polarity reversal protection.
 Type of protection: IP67.
 See LED instruction 2.

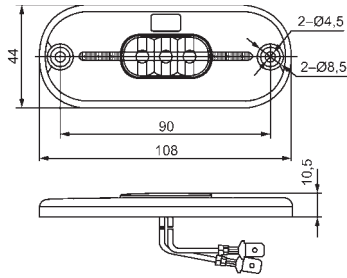

HELLA
VALUEFIT



HELLA
VALUEFIT



HELLA
VALUEFIT

Part no.	Pk.	
		With 5 red LEDs 0.5W.
2TM 357 009-011	1	Rear light with reflector, 12V
2TM 357 009-111	1	24V
		With 5 white LEDs 0.5W.
2PG 357 009-021	1	Position light with reflector, 12V
2PG 357 009-121	1	24V
		With 5 amber LEDs 0.5W.
2PS 357 009-001	1	Side-marker light with reflector, 12V
2PS 357 009-101	1	24V

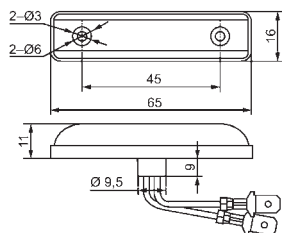

In LED-technology. With 150 mm long lead, 6.3 mm blade terminal contacts and insulating sleeves. Clear PMMA lens with reflector.

Consumption: 0.03A at 12V, 0.015A at 24V.
 Black ABS body.
 Two ST3.5 fixing screws.
 With polarity reversal protection.
 Type of protection: IP67.



HELLA
VALUEFIT



HELLA
VALUEFIT



HELLA
VALUEFIT

Part no.	Pk.	
		With 4 red LEDs 0.4W.
2TM 357 010-011	1	Rear light, 12V
2TM 357 010-111	1	24V
		With 4 white LEDs 0.4W.
2PG 357 010-021	1	Position light, 12V
2PG 357 010-121	1	24V
		With 4 amber LEDs 0.4W.
2PS 357 010-001	1	Side-marker light, 12V
2PS 357 010-101	1	24V

For horizontal or vertical surface mounting

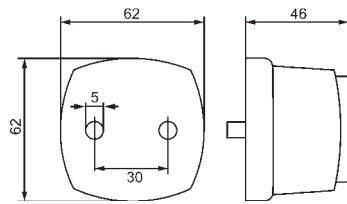

PMMA lens.
With 6.3 mm blade terminal contacts.
 Black ABS body.
 Two M5 fixing screws.
 With polarity reversal protection.
 Type of protection: IP67.



HELLA
VALUEFIT

Part no.	Pk.	
2TM 357 012-011	1	Red lens. Rear light with reflector
9EL 357 012-111	1	Spare parts/Accessories: Lens
8GM 002 092-121	10	C5W bulb,
8GM 002 092-241	10	12V
		24V
		Clear lens.
2PG 357 012-021	1	Position light with reflector
9EL 357 012-121	1	Spare parts/Accessories: Lens
8GM 002 092-121	10	C5W bulb,
8GM 002 092-241	10	12V
		24V
		Amber lens.
2PS 357 012-001	1	Side-marker light with reflector
9EL 357 012-101	1	Spare parts/Accessories: Lens
8GM 002 092-121	10	C5W bulb,
8GM 002 092-241	10	12V
		24V



HELLA
VALUEFIT



HELLA
VALUEFIT

For surface mounting

In LED-technology. With 20 LEDs and 300 mm long lead with stripped ends. PMMA lens.

Black ABS body.

Two M6 fixing screws.

With polarity reversal protection.

Voltage range: 10V - 30V. Type of protection: IP67.

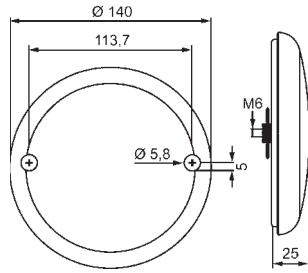

HELLA
VALUEFIT

Part no.	Pk.	
		Rear light: 0.5W, stop light: 3.0W, indicator light: 6.0W. Consumption: rear light: 0,04A at 12V, 0,02A at 24V, stop light: 0,25A at 12V, 0,125A at 24V, indicator light: 0.5A at 12V, 0.25A at 24V. See LED instruction 1.
2SD 357 026-001	1	Rear-stop-indicator light
5DS 357 030-001	1	Accessories: Indicator control unit, 12V
5DS 357 030-011	1	24V
		Rear light: 0.5W, stop light: 3.0W. Consumption: rear light: 0,04A at 12V, 0,02A at 24V, stop light: 0,25A at 12V, 0,125A at 24V. See LED instruction 2.
		Rear-stop light
		Interior light: 6.0W. Consumption: 0.5A bei 12V, 0.25A bei 24V. See LED instruction 3.
		Indicator light
		Accessories: Indicator control unit, 12V
		24V
		Rear fog light: 3.0W. Consumption: 0.25A at 12V, 0.125A at 24V. See LED instruction 2.
		Rear fog light
		Reverse light: 3.0W. Consumption: 0.25A at 12V, 0.125A at 24V. See LED instruction 2.
		Reverse light



HELLA
VALUEFIT

2SB 357 026-011

1 Rear-stop light



HELLA
VALUEFIT

2BA 357 026-021

1 Indicator light



HELLA
VALUEFIT

2NE 357 026-031

1 Rear fog light



HELLA
VALUEFIT

2ZR 357 026-041

1 Reverse light

For flush mounting

In LED-technology. With 24 LEDs and 260 mm long lead with stripped ends. Clear PMMA lens.

Black ABS/PC body. Two M6 fixing screws.

With polarity reversal protection.

Voltage range: 10V - 30V. Type of protection: IP67.

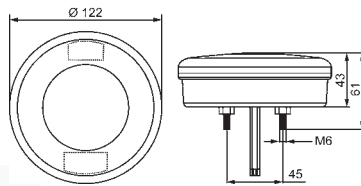

HELLA
VALUEFIT

Part no.	Pk.	
2SD 357 027-001	1	<p>Rear light: 0.5W, stop light: 2.0W, indicator light: 2.0W. Consumption: rear light: 0.04A at 12V, 0.02A at 24V, stop light: 0.16A at 12V, 0.08A at 24V, indicator light: 0.16A at 12V, 0.08A at 24V. See LED instruction 1.</p> <p>Rear-stop-indicator light</p> <p>Accessories: Indicator control unit, 1 12V 1 24V</p>
5DS 357 030-001 5DS 357 030-011	1 1	
2SB 357 027-011	1	<p>Rear light: 0.5W, stop light: 2.0W. Consumption: rear light: 0.04A at 12V, 0.02A at 24V, stop light: 0.16A at 12V, 0.08A at 24V. See LED instruction 2.</p> <p>Rear-stop light</p>
2BA 357 027-021	1	<p>Indicator light: 2.0W. Consumption: 0.16A at 12V, 0.08A at 24V. See LED instruction 3.</p> <p>Indicator light</p> <p>Accessories: Indicator control unit, 1 12V 1 24V</p>
5DS 357 030-001 5DS 357 030-011	1 1	
2BE 357 027-061	1	<p>Indicator light: 2.0W, position light: 0.5W. Consumption: indicator light: 0.16A at 12V, 0.08A at 24V, position light: 0.04A at 12V, 0.08A at 24V. See LED instruction 1.</p> <p>Indicator-position light</p> <p>Accessories: Indicator control unit, 1 12V 1 24V</p>
5DS 357 030-001 5DS 357 030-011	1 1	
2NE 357 027-031	1	<p>Rear fog light: 3.0W. Consumption: 0.25A at 12V, 0.125A at 24V. See LED instruction 2.</p> <p>Rear fog light</p>
2ZR 357 027-041	1	<p>Reverse light: 2.5W. Consumption: 0.21A at 12V, 0.10A at 24V. See LED instruction 2.</p> <p>Reverse light</p>
2NR 357 027-051	1	<p>Rear fog light: 3.0W, reverse light: 2.5W. Consumption: rear fog light: 0.25A at 12V, 0.125A at 24V, reverse light: 0.21A at 12V, 0.10A at 24V. See LED instruction 2.</p> <p>Rear fog-reverse light</p>

For flush mounting

In LED-technology. With 17 LEDs (reverse light with 12 LEDs) and 260 mm long lead with stripped ends. Clear PMMA lens.
 Black ABS/PC body. Two ST4.2 fixing screws.
 With polarity reversal protection.
 Voltage range: 10V - 30V. Type of protection: IP67.

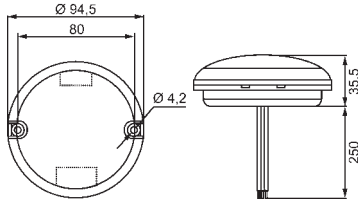

HELLA
VALUEFIT

Part no.	Pk.	
2SD 357 028-001	1	<p>Rear light: 0.5W, stop light: 2.0W, indicator light: 2.0W. Consumption: rear light: 0.04A at 12V, 0.02A at 24V, stop light: 0.16A at 12V, 0.08A at 24V, indicator light: 0.16A at 12V, 0.08A at 24V. See LED instruction 1.</p> <p>Rear-stop-indicator light</p> <p>Accessories: Indicator control unit, 1 12V 1 24V</p>
5DS 357 030-001 5DS 357 030-011	1 1	
2SB 357 028-011	1	<p>Rear light: 0.5W, stop light: 2.0W. Consumption: rear light: 0.04A at 12V, 0.02A at 24V, indicator light: 0.16A at 12V, 0.08A at 24V. See LED instruction 2.</p> <p>Rear-stop light</p>
2BA 357 028-021	1	<p>Indicator light: 2.0W. Consumption: 0.16A at 12V, 0.08A at 24V. See LED instruction 3.</p> <p>Indicator light</p> <p>Accessories: Indicator control unit, 1 12V 1 24V</p>
5DS 357 030-001 5DS 357 030-011	1 1	
2BE 357 028-051	1	<p>Indicator light: 2.0W, position light: 0.5W. Consumption: indicator light: 0.16A at 12V, 0.08A at 24V, position light: 0.04A at 12V, 0.02A at 24V. See LED instruction 1.</p> <p>Indicator-position light</p> <p>Accessories: Indicator control unit, 1 12V 1 24V</p>
5DS 357 030-001 5DS 357 030-011	1 1	
2NE 357 028-031	1	<p>Rear fog light: 3.0W. Consumption: 0.25A at 12V, 0.125A at 24V. See LED instruction 2.</p> <p>Rear fog light</p>
2ZR 357 028-041	1	<p>Reverse light: 1.5W. Consumption: 0.125A at 12V, 0.06A at 24V. See LED instruction 2.</p> <p>Reverse light</p>



HELLA
VALUEFIT



HELLA
VALUEFIT



HELLA
VALUEFIT



HELLA
VALUEFIT

For flush mounting

In LED-technology. With 150 mm long lead and 2.8 mm blade terminal contacts.
Clear PMMA lens.

Power consumption: 0.6W at 12V, 1.2W at 24V.

Consumption: 0.05A at 12V/24V.

Black ABS body.

With polarity reversal protection.

Voltage range: 9V - 33V. Type of protection: IP67.

See LED instruction 2.

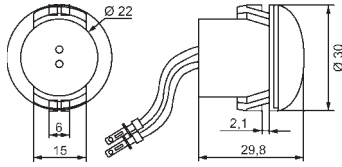

HELLA
VALUEFIT

Part no.	Pk.	
2TM 357 011-011	1	With 1 red LED.
		Rear light
2PG 357 011-021	1	With 1 white LED.
		Position light
2PS 357 011-001	1	With 1 amber LED.
		Side-marker light



HELLA
VALUEFIT



HELLA
VALUEFIT

For surface mounting

In LED-technology. With 4 white LEDs 1.0W and 250 mm long lead with stripped ends.

Clear PMMA lens.

Consumption: 0.08A at 12V, 0.04A at 24V.

Black ABS body.

Two ST4.2 fixing screws.

With polarity reversal protection.

Voltage range: 10V - 30V. Type of protection: IP67.

See LED instruction 2.



HELLA
VALUEFIT

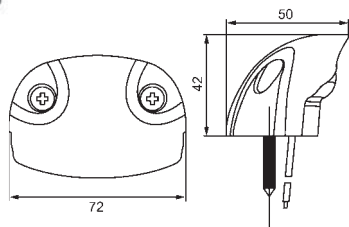

Part no.	Pk.	
2KA 357 013-001	1	Licence plate light

Clear PMMA lens.

Black ABS body.

Two M6 fixing screws.

With 6.3 mm blade terminals.

Voltage range: 12V - 24V.

See LED instruction 2.



HELLA
VALUEFIT

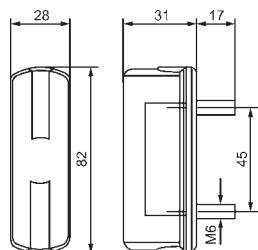

Part no.	Pk.	
2KA 357 014-001	1	Licence plate light
Accessories:		
		C5W bulb,
8GM 002 092-121	10	12V
8GM 002 092-241	10	24V

For side mounting on trailer



**In LED-technology. Clear PMMA lens.
With 2 white LEDs for position light,
2 red LEDs for clearance light,
1 amber LED for side-marker light, 1.6W
and 250 mm long lead with stripped ends.**

Consumption: 0.14A at 12V, 0.07A at 24V.
Black rubber body and rubber arm.
Four fixing screws ST3.5.
With polarity reversal protection.
Voltage range: 10V - 30V. Type of protection: IP67.
See LED instruction 2.

HELLA
VALUEFIT

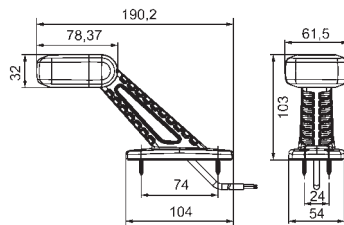

Part no.	Pk.	
2XS 357 006-011	1	Clearance light, left
2XS 357 006-021	1	right

2

For side upright mounting on trailer



**In LED-technology. Clear PMMA lens.
With 2 white LEDs for position light,
2 red LEDs for clearance light,
1 amber LED for side-marker light, 1.6W
and 250 mm long lead with stripped ends.**

Consumption: 0.14A at 12V, 0.07A at 24V.
Black rubber body and rubber arm.
Four fixing screws ST3.5.
With polarity reversal protection.
Voltage range: 10V - 30V. Type of protection: IP67.
See LED instruction 2.

HELLA
VALUEFIT

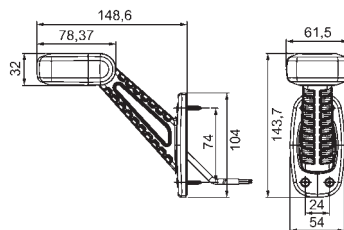

Part no.	Pk.	
2XS 357 007-011	1	Clearance light, left
2XS 357 007-021	1	right

For side mounting on trailer



HELLA
VALUEFIT

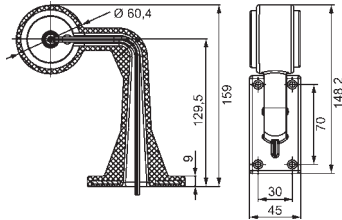

In LED-technology. Clear PMMA lens.

With 4 white LEDs for position light, 4 red LEDs for clearance light 1.0W and 50 mm long lead with stripped ends.

Consumption: 0.08A at 12V, 0.04A at 24V.

Black rubber body and rubber arm.

Four fixing screws ST4.2.

With polarity reversal protection.

Voltage range: 10V - 30V. Type of protection: IP67.

See LED instruction 2.

Part no.	Pk.	
2XS 357 005-011	1	Clearance light, left
2XS 357 005-021	1	right

For side upright mounting on trailer



HELLA
VALUEFIT

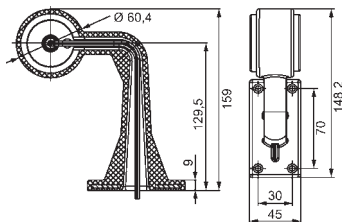

In LED-technology. Clear PMMA lens.

With 4 white LEDs for position light, 4 red LEDs for clearance light 1.0W and 50 mm long lead with stripped ends.

Consumption: 0.08A at 12V, 0.04A at 24V.

Black rubber body and rubber arm.

Four fixing screws ST4.2.

With polarity reversal protection.

Voltage range: 10V - 30V. Type of protection: IP67.

See LED instruction 2.

Part no.	Pk.	
2XS 357 005-031	1	Clearance light, left
2XS 357 005-041	1	right

For side mounting on trailer

In LED-technology. Clear PMMA lens.
With 4 white LEDs for position light, 4 red LEDs for clearance light 1.0W and 70 mm long lead with stripped ends.

Consumption: 0.08A at 12V, 0.04A at 24V.
 Black rubber body and rubber arm.
 Four fixing screws ST4.2.
 With polarity reversal protection.
 Voltage range: 10V - 30V. Type of protection: IP67.
 See LED instruction 2.



HELLA
VALUEFIT

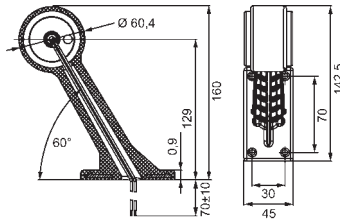

Part no.	Pk.	
2XS 357 004-011	1	Clearance light, left
2XS 357 004-021	1	right

For side upright mounting on trailer

In LED-technology. Clear PMMA lens.
With 4 white LEDs for position light, 4 red LEDs for clearance light 1.0W and 70 mm long lead with stripped ends.

Consumption: 0.08A at 12V, 0.04A at 24V.
 Black rubber body and rubber arm.
 Four fixing screws ST4.2.
 With polarity reversal protection.
 Voltage range: 10V - 30V. Type of protection: IP67.
 See LED instruction 2.

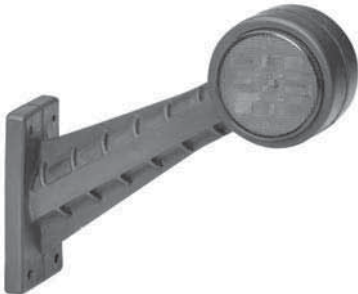

HELLA
VALUEFIT

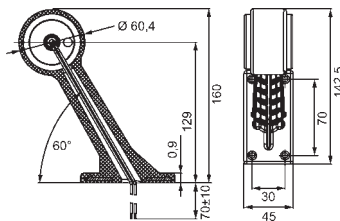

Part no.	Pk.	
2XS 357 004-031	1	Clearance light, left
2XS 357 004-021	1	right

Clearance lights

Safety brake lights



For side, horizontal or vertical surface mounting on trailer

In LED-technology. Clear PMMA lens.
With 4 white LEDs for position light, 4 red LEDs for clearance light 1.0W and 200 mm long lead with stripped ends.

Consumption: 0.08A at 12V, 0.04A at 24V.
 Black rubber body and rubber arm.
 Four fixing screws ST4.2.
 With polarity reversal protection.
 Voltage range: 10V - 30V. Type of protection: IP67.
 See LED instruction 2.



HELLA
VALUEFIT

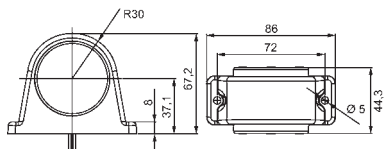

Part no.	Pk.	
2XS 357 003-001	1	Clearance light

For surface or flush mounting

In LED-technology. With 24 red LEDs and 250 mm long lead with stripped ends.
Clear PMMA lens.

Consumption: 0.21A.
 Black rim. Two ST4.2 fixing screws.
 With polarity reversal protection.
 Type of protection: IP67.
 See LED instruction 2.



HELLA
VALUEFIT

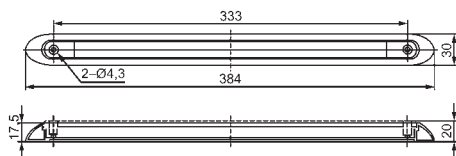

Part no.	Pk.	
2DA 357 015-001	1	Safety brake light, 12V2.5W
2DA 357 015-101	1	24V5.0W



Codes	3.02-3.03
Rotating beacons, flashing beacons, warning lights	
Rotating beacons and spare parts	3.04-3.13
Flashing beacons and spare parts	3.14-3.18, 3.29
LED-flashing beacons and spare parts	3.19-3.23, 3.30-3.32
Accessories for rotating- and flashing beacons	3.24-3.25
Spare parts for old-type rotating- and flashing beacons	3.26-3.28
Accessories for old-type rotating- and flashing beacons	3.26-3.28
Rear warning lights	3.33-3.34
Optical warning systems	
Raptor: Product descriptions and accessories	3.35-3.36
OWS 7: Product descriptions and spare parts	3.37-3.53
OWS-QS: Spare parts and accessories	3.54-3.55
OWS 540 to 1600: Product descriptions, spare parts and accessories	3.56-3.61
OWS 4: Spare parts for old-type systems	3.62
Rotating-/flashing beacon and siren combinations	
RTK 7: Product descriptions, spare parts and accessories	3.63-3.73
RTK-VE 7: Product descriptions and accessories	3.74-3.76

Code	Explanation
AAS	Acoustic stop signal
AIRHORN	Electric horn
AL	Stop light
ALL	Alley Light (close-range illumination) left
ALR	Alley Light (close-range illumination) right
ASG	Stop signal
ASG-GL	Stop signal in bulb-technology
ASG-LED	Stop signal in LED-technology
ASG-LED-Matrix	Stop signal in LED-technology (programmable)
ASW	Work light
AZD	Push-pull-rotary alarm switch (mechanical operating concept)
BSF-LED	Driving strobe light
BSN-LED	Close-range strobe headlight
BST	Flash light triple (3-way flash)
BSX	Strobe beacons
C-LED	Corner light
CANopenCiA 447	HighSpeed-CAN for RTK-modules to CiA447
DIN	DIN 14610 tone sequence
eAZD	Electronic control unit
EMV	Electromagnetic compatibility
eNF	Electronic operating concept for the control of communication functions in special signal systems
FL	Rotating beacon with tubular fitting for support
FuG	Standardised two-way radio
HDK	Horn pushbutton/horn
HILO	High-low two-tone sequence 1
HILO2	High-low two-tone sequence 2
HKL	Main rotating beacon
HWL	Warning light
HWL-LED	Warning light in LED-technology
HWL-X	Warning light in xenon-technology
KL	Rotating beacon
KL-A	Tripod for fitting a high-mounted beacon
KLF	Tone sequence
KLFB	Tone sequence standby
K-LED	LED beacon
KL-ER	Beacon with single reflector system (for roof bar systems)
KL-MR	Beacon with multiple reflector system (for roof bar systems)
KL-LM2	Beacon with LED 2-level module system
KL-LM3	Beacon with LED 2-level module system and additional optics for amber warning light
KL-LM4	Beacon with LED 2-level module system and LED rotation function
KL-LM5	Beacon with LED 2-level module system and flashing infrared signal
KL-LM6	Beacon with LED 2-level module system, LED rotation function and rotating infrared signal
KL-LM7	Beacon with LED 2-level module system, LED rotation function and infrared flight visibility marker

Codes	Explanation
KL-LR 2	Beacon with LED trough module system (for roof bar systems)
KLX	Strobe beacon
KL-XL	Beacon with xenon-double flashing system
KL-XL2	Beacon with xenon-double flashing system
KL-XR	Beacon with xenon-parabolic trough reflector system
KL-XR2	Beacon with xenon-parabolic trough reflector system
KSK	Cross signal button
LSB	LED Signal Bar, chaser light
LSP	Loudspeaker
LSP-H	Loudspeaker, rear
LSP-V	Loudspeaker, front
M	Beacon attachment variant with magnetic attachment
MAN	Manual siren
OWS	Optical warning system
OWS 4	Optical warning system (old-type)
OWS-MR	Optical warning system with multiple reflector system
OWS-X	Optical warning system with xenon system
PC	Polycarbonate
R	Rotating beacon with tubular fitting for support
RTK	Rotating beacon and siren combinations
RTK-VE	Sound warning system
SB	Rotating beacon with single bolt for fitting
SOR	Sound Order Readyness
Teledux 9	non-standardised two-way radio
WAIL	Slow siren
WL-LED	Warning light in LED-technology
YELP	Fast siren
ZSE	Control unit light
ZSE L	Control unit light
ZSE L/A	Control unit light and acoustic
ZSE-VE	Control unit

Rotating beacons with halogen H1 light

KL Rotaflex FL

According to DIN 14 620, shape A, n = 160 U/min.
 With built-in bulb. Light aperture (reflector dia.): 76.5 mm.
 Black base with tubular fitting for support,
 max. inclination 90°.
 Total power consumption: 12V55W = 5.5A, 24V70W = 3.5A.
 Operating temperature: -40 °C to +60 °C.
 RF suppression: CISPR 25, class 5 (conducted).
 Resistant to high pressure cleaning.

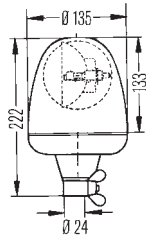

Part no.	Pk.	
		Rotating beacon,
2RL 006 846-101	1	blue, 12V
2RL 006 846-111	1	blue, 24V
2RL 006 846-001	1	amber, 12V
2RL 006 846-011	1	amber, 24V
		Spare parts:
		Dome,
9EL 859 020-101	1	blue
9EL 859 020-001	1	amber (Polycarbonat)
9GP 859 115-001	1	Rubber body
		Motor,
9MN 858 114-001	1	12V
9MN 858 114-011	1	24V
9DX 860 438-001	1	Reflector
		H1 bulb,
8GH 002 089-133	1	12V55W
8GH 002 089-251	1	24V70W

KL Rotafix F

According to DIN 14 620 form B1, n = 160 U/min.
 With built-in bulb. Light aperture (reflector dia.): 76.5 mm.
 Black base for permanent mounting on level surface.
 Total power consumption: 12V55W = 5.5A, 24V70W = 3.5A.
 Operating temperature: -40 °C to +60 °C.
 RF suppression: CISPR 25, class 5 (conducted).
 Resistant to high pressure cleaning.

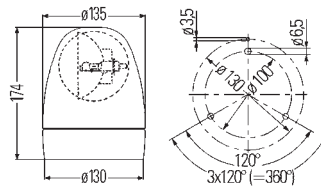

Part no.	Pk.	
		Rotating beacon,
2RL 007 337-101	1	blue, 12V
2RL 007 337-111	1	blue, 24V
2RL 007 337-001	1	amber, 12V
2RL 007 337-011	1	amber, 24V
2RL 007 337-041	1	with 24V bulb and belt drive, amber, 12V/24V
		Spare parts:
		Dome,
9EL 859 020-101	1	blue
9EL 859 020-001	1	amber (Polycarbonat)
		Motor,
9MN 858 114-001	1	12V
9MN 858 114-011	1	24V
9MN 862 741-001	1	12V/24V for -041
9XR 854 840-001	1	Drive belts (2 pieces) for -041
		Reflector
9DX 860 271-001	1	for 2RL 007 337-... (except -041)
9DX 862 844-001	1	for 2RL 007 337-041
		H1 bulb,
8GH 002 089-133	1	12V55W
8GH 002 089-251	1	24V70W

Rotating beacons with halogen H1 light

KL Rotafix M

According to DIN 14 620 form B1, n = 160 U/min.

With built-in bulb. Light aperture (reflector dia.): 76.5 mm.

Black base with magnetic attachment, spirally-coiled lead extends up to 2.5 m and 2-pole plug for connecting to the cigarette lighter socket.

Total power consumption: 12V55W = 5.5A, 24V70W = 3.5A.

Operating temperature: -40 °C to +60 °C.

RF suppression: CISPR 25, class 5 (conducted).

Resistant to high pressure cleaning.

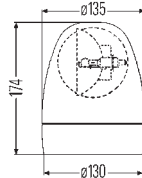

Part no.	Pk.	
2RL 007 337-121	1	Rotating beacon, blue, 12V
2RL 007 337-021	1	amber, 12V
2RL 007 337-031	1	amber, 24V
2RL 007 337-057	1	with spirit level, amber, 24V
Spare parts:		
Dome,		
9EL 859 020-101	1	blue
9EL 859 020-001	1	amber (Polycarbonat)
Motor,		
9MN 858 114-001	1	12V
9MN 858 114-011	1	24V
9DX 860 271-001	1	Reflector
H1 bulb,		
8GH 002 089-133	1	12V55W
8GH 002 089-251	1	24V70W

KL JuniorPlus F

According to DIN 14 620, shape B1, n = 180 U/min.

Light aperture (reflector dia.): 95 mm.

Base for permanent mounting.

Total power consumption: 12V55W = 5A, 24V70W = 3A.

Operating temperature: -40 °C to +60 °C.

RF suppression: CISPR 25, class 3 (conducted).

Resistant to high pressure cleaning.

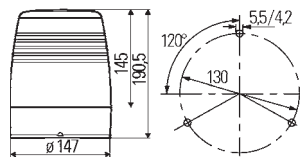

Part no.	Pk.	
2RL 008 965-031	1	Rotating beacon with black base, with bulb, blue, 12V
2RL 008 965-041	1	with bulb, blue, 24V
Rotating beacon with amber base,		
2RL 008 965-001	1	with bulb, amber, 12V
2RL 008 965-011	1	with bulb, amber, 24V
2RL 008 965-021	1	without bulb, amber, 12V/24V
Spare parts:		
Dome,		
9EL 863 100-041	1	blue
9EL 863 100-001	1	amber
9MN 863 026-001	1	Motor, 12V/24V
9XR 855 975-001	1	Drive belts (2 pieces)
H1 bulb,		
8GH 002 089-133	1	12V55W
8GH 002 089-251	1	24V70W

Rotating beacons with halogen H1 light

KL JuniorPlus M

According to DIN 14 620, shape B1, n = 180 U/min.
Light aperture (reflector dia.): 95 mm.

With magnetic attachment, spirally-coiled lead extends up to 3.5 m and 2-pole plug for connecting to the cigarette lighter socket.

Total power consumption: 12V55W = 5A, 24V70W = 3A.

Operating temperature: -40 °C to +60 °C.

RF suppression: CISPR 25, class 3 (conducted).

Resistant to high pressure cleaning.

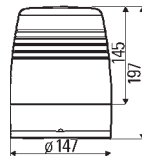

Part no.	Pk.	
2RL 008 966-031	1	Rotating beacon with black base, with bulb, blue, 12V
2RL 008 966-001	1	Rotating beacon with amber base, with bulb, amber, 12V
2RL 008 966-021	1	Rotating beacon without bulb, amber, 12V/24V
Spare parts:		
9EL 863 100-041	1	Dome, blue
9EL 863 100-001	1	Dome, amber
9MN 863 026-001	1	Motor, 12V/24V
9XR 855 975-001	1	Drive belts (2 pieces)
8GH 002 089-133	1	H1 bulb, 12V55W
8GH 002 089-251	1	H1 bulb, 24V70W

KL JuniorPlus FL

According to DIN 14 620 Form A, n = 180 U/min.
Light aperture (reflector dia.): 95 mm.

Base plate with flexible tubular fitting for support tube, max. inclination 90°.

Total power consumption: 12V55W = 5A, 24V70W = 3A.

Operating temperature: -40 °C to +60 °C.

RF suppression: CISPR 25, class 3 (conducted).

Resistant to high pressure cleaning.

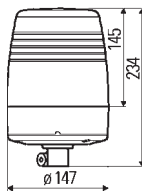

Part no.	Pk.	
2RL 008 967-031	1	Rotating beacon with black base, with bulb, blue, 12V
2RL 008 967-041	1	Rotating beacon with black base, with bulb, blue, 24V
2RL 008 967-001	1	Rotating beacon with amber base, with bulb, amber, 12V
2RL 008 967-011	1	Rotating beacon with amber base, with bulb, amber, 24V
2RL 008 967-021	1	Rotating beacon without bulb, amber, 12V/24V
Spare parts:		
9EL 863 100-041	1	Dome, blue
9EL 863 100-001	1	Dome, amber
9MN 863 026-001	1	Motor, 12V/24V
9XR 855 975-001	1	Drive belts (2 pieces)
8GH 002 089-133	1	H1 bulb, 12V55W
8GH 002 089-251	1	H1 bulb, 24V70W

Rotating beacons with halogen H1 light

KL JuniorPlus SB

According to DIN 14 620 Form A, n = 180 U/min.

Light aperture (reflector dia.): 95 mm.

Base plate with single bolt for fitting.

Total power consumption: 2V55W = 5A, 24V70W = 3A.

Operating temperature: -40 °C to +60 °C.

RF suppression: CISPR 25, class 3 (conducted).

Resistant to high pressure cleaning.

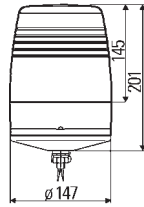

Part no.	Pk.	
2RL 008 990-021	1	Rotating beacon without bulb, amber, 12V/24V
Spare parts:		
9EL 863 100-041	1	Dome, blue
9EL 863 100-001	1	amber
9MN 863 026-001	1	Motor, 12V/24V
9XR 855 975-001	1	Drive belts (2 pieces)
8GH 002 089-133	1	H1 bulb, 12V55W
8GH 002 089-251	1	24V70W

KL Junior F

According to DIN 14 620, shape B1, n = 160 U/min.

Light aperture (reflector dia.): 103 mm.

Amber base for permanent mounting.

Total power consumption: 12V55W = 5.5A, 24V70W = 3.5A.

Operating temperature: -20 °C to +60 °C.

RF suppression: CISPR 25, class 3 (conducted).

Resistant to high pressure cleaning.

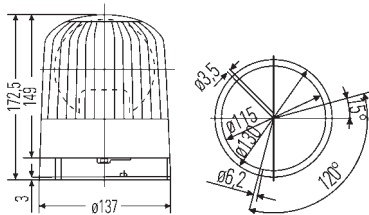

Part no.	Pk.	
2RL 007 550-001	1	Rotating beacon with bulb, amber, 12V
2RL 007 550-011	1	with bulb, amber, 24V
2RL 007 550-021	1	without bulb, amber, 12V/24V
Spare parts/Accessories:		
9EL 860 627-001	1	Dome, amber
9EL 860 628-021	1	blue
9MN 860 677-001	1	Motor, 12V
9MN 860 677-011	1	24V
9MN 860 677-021	1	12V/24V
8GH 002 089-133	1	H1 bulb, 12V55W
8GH 002 089-251	1	24V70W

Rotating beacons with halogen H1 light

KL Junior M

According to DIN 14 620, shape B1, n = 160 U/min.

Light aperture (reflector dia.): 103 mm.

Amber base with magnetic attachment, spirally-coiled lead extends up to 3.5 m and 2-pole plug for connecting to the cigarette lighter socket.

Total power consumption: 12V55W = 5.5A, 24V70W = 3.5A.

Operating temperature: -20 °C to +60 °C.

RF suppression: CISPR 25, class 3 (conducted).

Resistant to high pressure cleaning.

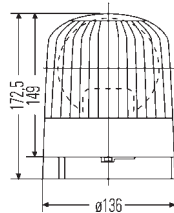

Part no.	Pk.	
		Rotating beacon
2RL 007 552-001	1	with bulb, amber, 12V
2RL 007 552-011	1	with bulb, amber, 24V
2RL 007 552-021	1	without bulb, amber, 12V/24V
		Spare parts/Accessories:
		Dome,
9EL 860 627-001	1	amber
9EL 860 628-021	1	blue
		Motor,
9MN 860 677-001	1	12V
9MN 860 677-011	1	24V
9MN 860 677-021	1	12V/24V
		H1 bulb,
8GH 002 089-133	1	12V55W
8GH 002 089-251	1	24V70W

KL Junior R

According to DIN 14 620 shape A, n = 160 U/min.

Light aperture (reflector dia.): 103 mm.

Amber base with flexible tubular fitting for support tube.

Total power consumption: 12V55W = 5.5A, 24V70W = 3.5A.

Operating temperature: -20 °C to +60 °C.

RF suppression: CISPR 25, class 3 (conducted).

Resistant to high pressure cleaning.

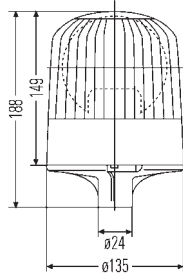

Part no.	Pk.	
		Rotating beacon
2RL 007 551-001	1	with bulb, amber, 12V
2RL 007 551-011	1	with bulb, amber, 24V
2RL 007 551-021	1	without bulb, amber, 12V/24V
		Spare parts/Accessories:
		Dome,
9EL 860 627-001	1	amber
9EL 860 628-021	1	blue
		Motor,
9MN 860 677-001	1	12V
9MN 860 677-011	1	24V
9MN 860 677-021	1	12V/24V
		H1 bulb,
8GH 002 089-133	1	12V55W
8GH 002 089-251	1	24V70W

Rotating beacons with halogen H1 light

KL Junior FL

According to DIN 14 620 shape A, n = 160 U/min.
With PC light dome. Light aperture (reflector dia.): 103 mm.
 Base with flexible tubular fitting for support tube, max. inclination 90°.
 Total power consumption: 12V55W = 5.5A, 24V70W = 3.5A.
 Operating temperature: -20 °C to +60 °C.
 RF suppression: CISPR 25, class 3 (conducted).
 Resistant to high pressure cleaning.

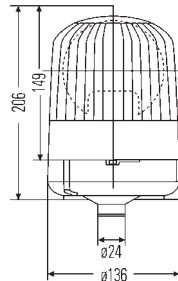

Part no.	Pk.	
		Rotating beacon
2RL 007 553-001	1	with bulb, amber, 12V
2RL 007 553-011	1	with bulb, amber, 24V
2RL 007 553-021	1	without bulb, amber, 12V/24V
		Spare parts/Accessories:
		Dome,
9EL 860 627-011	1	amber (Polycarbonat)
9EL 860 628-021	1	blue
		Motor,
9MN 860 677-001	1	12V
9MN 860 677-011	1	24V
9MN 860 677-021	1	12V/24V
		H1 bulb,
8GH 002 089-133	1	12V55W
8GH 002 089-251	1	24V70W

KL 5000 M

According to DIN 14 620, shape B1, n = 160 U/min.
With built-in 12V bulb. Light aperture (reflector dia.): 76 mm.
 Black base with magnetic attachment, spirally-coiled lead extends up to 2.5 m and 2-pole plug for connecting to the cigarette lighter socket or boardsocket to DIN EN-ISO 4165.
 Total power consumption: 12V55W = 4.5A.
 Operating temperature: -40 °C to +60 °C.
 RF suppression: CISPR 25, class 5 (conducted).
 Resistant to high pressure cleaning.

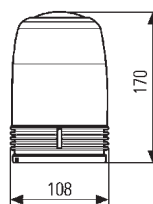

Part no.	Pk.	
2RL 008 364-021	1	Rotating beacon, blue, 12V
		Spare parts/Accessories:
9EL 862 267-031	1	Dome, blue
9XR 854 840-001	1	Drive belts (2 pieces)
8JB 004 777-002	1	Boardsocket, 2-pole
8JB 004 777-001	5	
8GH 002 089-133	1	H1 bulb, 12V55W

Rotating beacons with halogen H1 light

KL 7000 F

According to DIN 14 620, shape B1, n = 160 U/min.
 With built-in bulb. Light aperture (reflector dia.): 84 mm.
 Base with three-point mounting and rubber gasket for permanent mounting.
 Total power consumption: 12V55W = 5.5A, 24V70W = 3.5A.
 Operating temperature: -40 °C to +60 °C.
 RF suppression: CISPR 25, class 5 (conducted).
 Resistant to high pressure cleaning.

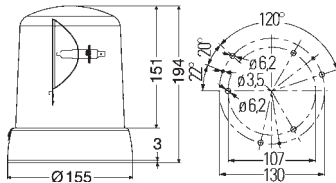

Part no.	Pk.	
2RL 008 061-001	1	Rotating beacon with black base, blue, 12V
2RL 008 061-011	1	blue, 24V
2RL 008 061-101	1	Rotating beacon with amber base, amber, 12V
2RL 008 061-111	1	amber, 24V
Spare parts:		
		Dome,
9EL 862 140-001	1	blue
9EL 862 141-001	1	amber
9EL 862 141-021	1	amber (Polycarbonat)
9MN 862 741-001	1	Motor, 12V/24V
9XR 854 840-001	1	Drive belts (2 pieces)
9DX 862 740-001	1	Reflector
9GD 862 164-001	5	Rubber gasket
		H1 bulb,
8GH 002 089-133	1	12V55W
8GH 002 089-251	1	24V70W

KL 7000 M

According to DIN 14 620, shape B1, n = 160 U/min.
 With built-in bulb. Light aperture (reflector dia.): 84 mm.
 Base with magnetic attachment, spirally-coiled lead extends up to 2.5 m and 2-pole plug for connecting to the cigarette lighter socket.
 Total power consumption: 12V55W = 5.5A, 24V70W = 3.5A.
 Operating temperature: -40 °C to +60 °C.
 RF suppression: CISPR 25, class 5 (conducted).
 Resistant to high pressure cleaning.

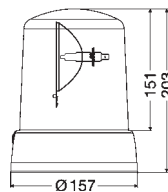

Part no.	Pk.	
2RL 008 062-001	1	Rotating beacon with black base, blue, 12V
2RL 008 062-011	1	blue, 24V
2RL 008 062-101	1	Rotating beacon with amber base, amber, 12V
2RL 008 062-111	1	amber, 24V
Spare parts:		
		Dome,
9EL 862 140-001	1	blue
9EL 862 141-001	1	amber
9EL 862 141-021	1	amber (Polycarbonat)
9MN 862 741-001	1	Motor, 12V/24V
9XR 854 840-001	1	Drive belts (2 pieces)
9DX 862 740-001	1	Reflector
		H1 bulb,
8GH 002 089-133	1	12V55W
8GH 002 089-251	1	24V70W

Rotating beacons with halogen H1 light

KL 7000 FL

According to DIN 14 620 shape A, n = 160 U/min.
With bulb. Light aperture (reflector dia.): 84 mm.

Base with flexible tubular fitting for support tube. Max. inclination 90°.

Total power consumption: 12V55W = 5.5A, 24V70W = 3.5A.

Operating temperature: -40 °C to +60 °C.

RF suppression: CISPR 25, class 5 (conducted).

Resistant to high pressure cleaning.

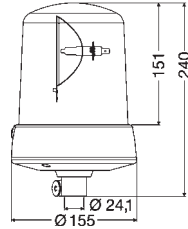

Part no.	Pk.	
		Rotating beacon with black base, blue, 12V
2RL 008 063-001	1	
2RL 008 063-011	1	blue, 24V
		Rotating beacon with amber base, amber, 12V
2RL 008 063-101	1	
2RL 008 063-111	1	amber, 24V
		Spare parts:
		Dome, blue
9EL 862 140-001	1	
9EL 862 141-001	1	amber
9EL 862 141-021	1	amber (Polycarbonat)
9MN 862 741-001	1	Motor, 12V/24V
9XR 854 840-001	1	Drive belts (2 pieces)
9DX 862 740-001	1	Reflector
		H1 bulb, 12V55W
8GH 002 089-133	1	
8GH 002 089-251	1	24V70W

KL 7000 R

According to DIN 14 620 shape A, n = 160 U/min.
With bulb. Light aperture (reflector dia.): 84 mm.

Base with tubular fitting for support tube.

Total power consumption: 12V55W = 5.5A, 24V70W = 3.5A.

Operating temperature: -40 °C to +60 °C.

RF suppression: CISPR 25, class 5 (conducted).

Resistant to high pressure cleaning.

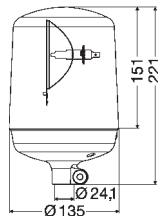

Part no.	Pk.	
		Rotating beacon with black base, blue, 12V
2RL 008 060-001	1	
2RL 008 060-011	1	blue, 24V
		Rotating beacon with amber base, amber, 12V
2RL 008 060-101	1	
2RL 008 060-111	1	amber, 24V
		Spare parts:
		Dome, blue
9EL 862 140-001	1	
9EL 862 141-001	1	amber
9EL 862 141-021	1	amber (Polycarbonat)
9MN 862 741-001	1	Motor, 12V/24V
9XR 854 840-001	1	Drive belts (2 pieces)
9DX 862 740-001	1	Reflector
		H1 bulb, 12V55W
8GH 002 089-133	1	
8GH 002 089-251	1	24V70W

Rotating beacons 230V

KL 7000 230V

According to DIN 14 620, shape B1, n = 160 U/min.

With rubber gasket and 230V25W.

Light aperture (reflector dia.): 84 mm.

Base with three-point mounting for mounting on emergency call box, fire-alarm box etc.

Total power consumption: 230V with 25W bulb = 0.2A.

Operating temperature: -30 °C to +60 °C.

Resistant to high pressure cleaning.

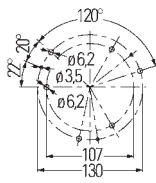
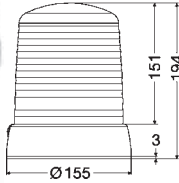

Part no.	Pk.	
2RL 008 064-101	1	Rotating beacon with amber base, amber, 230V
2RL 008 064-001	1	with black base, red, 230V
		Spare parts:
9EL 862 141-001	1	Dome with optical pattern, amber
9EL 862 141-021	1	amber (Polycarbonat)
9EL 862 141-011	1	red
9MN 854 290-001	1	Motor with gear unit, 240V
9GD 862 164-001	5	Rubber gasket
8GS 002 383-001	1	C2 bulb, 230V25W

Rotating beacons with halogen H1 light

KL 8000 F

According to DIN 14 620, shape B2, n = 160 U/min.

With rubber gasket and bulb.

Light aperture (reflector dia.): 111.6 mm.

Base for permanent mounting.

Two holes for M6 fixing screws or B4.2 tapping screws.

Total power consumption: 12V55W = 5.5A, 24V70W = 3.5A.

Operating temperature: -40 °C to +60 °C.

Resistant to high pressure cleaning.

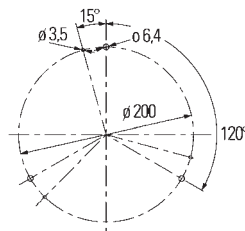
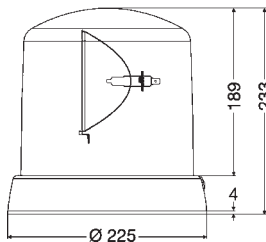

Part no.	Pk.	
		Rotating beacon with black base, blue, 12V
2RL 008 065-001	1	
2RL 008 065-011	1	blue, 24V
		Rotating beacon with amber base, amber, 12V
2RL 008 065-101	1	
2RL 008 065-107	48	
2RL 008 065-111	1	amber, 24V
		Spare parts:
		Dome,
9EL 862 171-001	1	blue
9EL 862 172-001	1	amber
9MN 862 741-001	1	Motor, 12V/24V
9XR 854 840-001	1	Drive belts (2 pieces)
9DX 862 742-001	1	Reflector
9GD 862 178-001	1	Rubber base, flat
		H1 bulb,
8GH 002 089-133	1	12V55W
8GH 002 089-251	1	24V70W
		Accessories:
		Rubber base, flat
9GD 862 178-001	1	
		high
9GD 862 734-001	1	
		wedge-shaped
9GD 859 037-011	1	

Electronic flashing beacons

KLX Junior Plus F

According to DIN 14 620, shape B1.
 For permanent mounting. PC dome.
 With built-in xenon tube (gas discharge bulb with plug-in base).
 Light aperture: 95 mm dia.

Total power consumption: 12V = 3.3A, 24V = 1.7A.
 Electrical strobe power: 10 + 2 Ws.
 Strobe frequency: 2.0Hz = double flashes.
 Operating temperature: -40 °C to +60 °C.
 RF suppression: CISPR 25, class 3 (conducted).
 Resistant to high pressure cleaning.

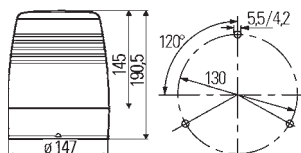

Part no.	Pk.	
2XD 009 051-021	1	Flashing beacon with black base, blue, 12V
2XD 009 051-001	1	Flashing beacon with amber base, amber, 12V
2XD 009 051-011	1	Flashing beacon with amber base, amber, 24V
Spare parts:		
		PC-dome,
9EL 863 100-051	1	blue
9EL 863 100-031	1	amber
9EL 862 678-001	1	Ring lens with Fresnel optics
8GS 863 261-001	1	Xenon tube

KLX Junior Plus M

According to DIN 14 620, shape B1.
 With magnetic attachment, spirally-coiled lead extends up to 3.5 m and 2-pole plug for connecting to cigarette lighter socket. PC dome.
 With built-in xenon tube (gas discharge bulb with plug-in base).
 Light aperture: 95 mm dia.

Total power consumption: 12V = 3.3A, 24V = 1.7A.
 Electrical strobe power: 10 + 2 Ws.
 Strobe frequency: 2.0Hz = double flashes.
 Operating temperature: -40 °C to +60 °C.
 RF suppression: CISPR 25, class 3 (conducted).
 Resistant to high pressure cleaning.

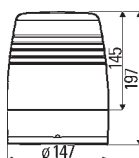

Part no.	Pk.	
2XD 009 053-021	1	Flashing beacon with black base, blue, 12V
2XD 009 053-001	1	Flashing beacon with amber base, amber, 12V
Spare parts:		
		PC-dome,
9EL 863 100-051	1	blue
9EL 863 100-031	1	amber
9EL 862 678-001	1	Ring lens with Fresnel optics
8GS 863 261-001	1	Xenon tube

Electronic flashing beacons

KLX Junior Plus FL

According to DIN 14 620, shape A.
With flexible tubular fitting for support tube, max. inclination 90°.
PC dome.

With built-in xenon tube (gas discharge bulb with plug-in base).
Light aperture: 95 mm dia.

Total power consumption: 12V = 3.3A, 24V = 1.7A.

Electrical strobe power: 10 + 2 Ws.

Strobe frequency: 2.0Hz = double flashes.

Operating temperature: -40 °C to +60 °C.

RF suppression: CISPR 25, class 3 (conducted).

Resistant to high pressure cleaning.

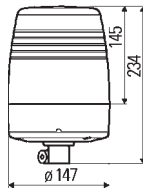

Part no.	Pk.	
		Flashing beacon with black base, blue, 12V
2XD 009 052-021	1	
2XD 009 052-031	1	blue, 24V
		Flashing beacon with amber base, amber, 12V
2XD 009 052-001	1	
2XD 009 052-011	1	amber, 24V
		Spare parts:
		PC-dome,
9EL 863 100-051	1	blue
9EL 863 100-031	1	amber
9EL 862 678-001	1	Ring lens with Fresnel optics
8GS 863 261-001	1	Xenon tube

KLX Junior Plus SB

According to DIN 14 620, shape A.

Single bolt for fitting. PC dome.

With built-in xenon tube (gas discharge bulb with plug-in base).

Light aperture: 95 mm dia.

Total power consumption: 12V = 3.3A, 24V = 1.7A.

Electrical strobe power: 10 + 2 Ws.

Strobe frequency: 2.0Hz = double flashes.

Operating temperature: -40 °C to +60 °C.

RF suppression: CISPR 25, class 3 (conducted).

Resistant to high pressure cleaning.

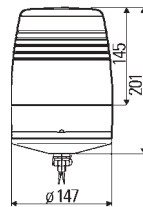

Part no.	Pk.	
		Flashing beacon with amber base, amber, 12V
2XD 009 054-001	1	
		Spare parts/Accessories:
		PC-dome,
9EL 863 100-031	1	amber
9EL 863 100-051	1	blue
9EL 862 678-001	1	Ring lens with Fresnel optics
8GS 863 261-001	1	Xenon tube

Electronic flashing beacons

KLX 5000 M

With magnetic attachment, integrated power supply and built-in xenon tube (gas discharge bulb).
Light aperture: 80 mm dia.

Shielding basket over xenon bulb reduces high-frequency interference radiation and ensures good radio reception.

Power consumption: 3A. Electrical strobe power: 10 + 2 Ws.

Strobe frequency: 2.1Hz = approx. 120 double flashes/min.

Operating temperature: -40 °C to +60 °C.

RF suppression: CISPR 25, class 5 (conducted).

Resistant to high pressure cleaning.

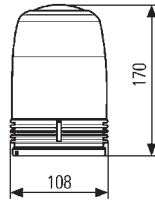

Part no.	Pk.	
2RL 008 366-021	1	Flashing beacon, blue, 12V, with spirally-coiled lead and 2-pole plug for connecting to the cigarette lighter socket
2RL 008 366-031	1	with spirally-coiled lead and Lemo plug
9EL 862 267-001	1	Spare parts/Accessories: PC-dome with lens
8GS 859 634-001	1	Xenon tube

KLX 7000 F

According to DIN 14 620, shape B1.

For permanent mounting. With built-in xenon tube (gas discharge bulb with plug-in base).

Light aperture: 90 mm dia.

Silver coloured metal body.

Total power consumption: 12V 3.3A, 24V 1.6A.

Operating temperature: -40 °C to +60 °C.

Electrical strobe power: 12 + 2 Ws.

Strobe frequency: 2.05Hz = double flashes.

RF suppression: CISPR 25, class 5 (conducted).

Resistant to high pressure cleaning.

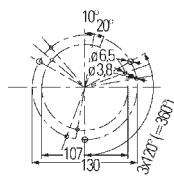
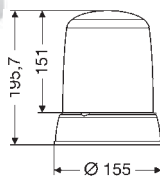

Part no.	Pk.	
2RL 008 181-001	1	Flashing beacon, blue, 12V
2RL 008 181-011	1	blue, 24V
2RL 008 181-101	1	amber, 12V
2RL 008 181-111	1	amber, 24V
9EL 862 140-021	1	Spare parts: PC-dome, blue
9EL 862 140-031	1	amber
9EL 862 678-001	1	Ring lens with Fresnel optics
8GS 859 634-001	1	Xenon tube
9HB 862 864-001	1	EMC shield for strobe lights
9GD 862 164-001	5	Rubber base, flat

Electronic flashing beacons

KLX 7000 M

According to DIN 14 620, shape B1.
 With magnetic attachment, spirally-coiled lead extends up to 2.5 m and 2-pole plug for connecting to cigarette lighter socket.
 Built-in xenon tube (gas discharge bulb with plug-in base).
 Light aperture: 90 mm dia.

Silver coloured metal body.
 Total power consumption: 12V 3.3A, 24V 1.6A.
 Operating temperature: -40 °C to +60 °C.
 Electrical strobe power: 12 + 2 Ws.
 Strobe frequency: 2.05Hz = double flashes.
 RF suppression: CISPR 25, class 5 (conducted).
 Resistant to high pressure cleaning.

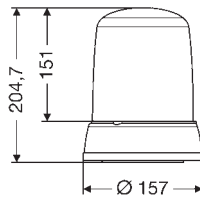

Part no.	Pk.	
2RL 008 182-001	1	Flashing beacon, blue, 12V
2RL 008 182-011	1	blue, 24V
2RL 008 182-101	1	amber, 12V
2RL 008 182-111	1	amber, 24V
Spare parts:		
		PC-dome,
9EL 862 140-021	1	blue
9EL 862 140-031	1	amber
9EL 862 678-001	1	Ring lens with Fresnel optics
8GS 859 634-001	1	Xenon tube
9HB 862 864-001	1	EMC shield for strobe lights

KLX 7000 FL

According to DIN 14 620, shape A.
 With flexible tubular fitting for support tube, max. inclination 90°.
 Built-in xenon tube (gas discharge bulb with plug-in base).
 Light aperture: 90 mm dia.

Silver coloured metal body.
 Total power consumption: 12V 3.3A, 24V 1.6A.
 Operating temperature: -40 °C to +60 °C.
 Electrical strobe power: 12 + 2 Ws.
 Strobe frequency: 2.05Hz = double flashes.
 RF suppression: CISPR 25, class 5 (conducted).
 Resistant to high pressure cleaning.

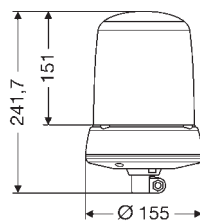

Part no.	Pk.	
2RL 008 183-001	1	Flashing beacon, blue, 12V
2RL 008 183-011	1	blue, 24V
2RL 008 183-101	1	amber, 12V
2RL 008 183-111	1	amber, 24V
Spare parts:		
		PC-dome,
9EL 862 140-021	1	blue
9EL 862 140-031	1	amber
9EL 862 678-001	1	Ring lens with Fresnel optics
8GS 859 634-001	1	Xenon tube
9HB 862 864-001	1	EMC shield for strobe lights

Electronic flashing beacons

KLX

According to DIN 14 620, shape B1.
 Built-in xenon tube (gas discharge bulb).
 Light aperture: 85 mm dia.

With black plastic base and rubber base plate for permanent mounting.
 Three holes for M6 x 35 or M5 x 35 fixing screws.
 Total power consumption: 12V 3.3A, 24V 1.7A.
 Electrical strobe power: 10+2 Ws.
 Strobe frequency: 2.0Hz = 120 flashes/min.
 Operating temperature: -40 °C to +60 °C.
 RF suppression: CISPR 25, class 3 (conducted).
 Resistant to high pressure cleaning.

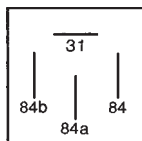
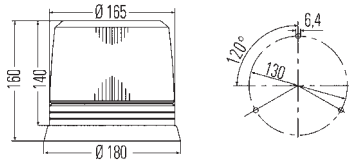

Part no.	Pk.	
2RL 007 017-041	1	Double flasher beacon, blue, 12V
2RL 007 017-051	1	blue, 24V
2RL 007 017-061	1	amber, 12V
2RL 007 017-071	1	amber, 24V
Spare parts:		
9EL 859 658-001	1	PC-dome, blue
9EL 859 658-011	1	amber
9GD 856 466-001	1	Rubber gasket
8GS 863 261-001	1	Xenon tube X1
Accessories:		
9GD 856 863-001	1	Rubber base (wedge-shaped) for mounting KLX on convex mounting surfaces
8HG 005 436-011	1	Holder for mounting KLX on 24 mm dia. attachment tube
5KG 007 629-001	1	Control unit with contact for control lamp and one beacon, 12V
5KG 007 629-011	1	24V

Flashing beacons

RotaLED

In LED-technology. Rotating light function. PC dome. Black rubber base.

Rated voltage: 12V / 24V.

Operating voltage: 10V - 32V.

Average current consumption: 12V 0.8A, 24V 0.4A.

Consumption: 10W.

Operating temperature: -40 °C to +60 °C.

RF suppression: CISPR 25, class 5 (conducted).

Resistant to high pressure cleaning. Type of protection: IP5KX, IPX4K, IPX9K.

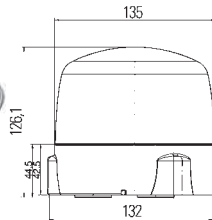
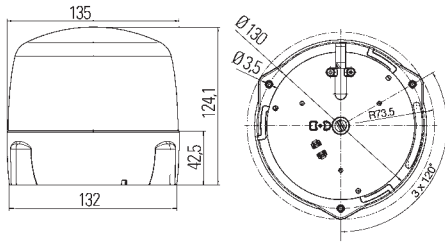

Part no.	Pk.	
2RL 010 979-101	1	LED beacon, according to DIN 14 620, shape B1, for permanent mounting, blue
2RL 010 979-001	1	amber
2RL 010 979-121	1	LED beacon, according to DIN 14 620, shape B1, with magnetic attachment, spirally-coiled lead extends up to 2.5 m and 2-pole plug for connecting to the cigarette lighter socket, blue
2RL 010 979-021	1	amber
2RL 010 979-111	1	LED beacon, according to DIN 14 620, shape A, with tubular fitting for support tube, blue
2RL 010 979-011	1	amber
9EL 181 506-011	1	Spare parts: Dome, blue
9EL 181 506-001	1	amber

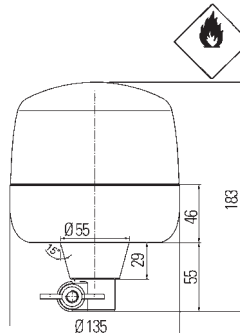

Flashing beacons

KL 7000 LED

In LED-technology. Rotating light function. PC dome.
Plastic base.

Rated voltage: 12V / 24V.

Operating voltage: 10V - 32V.

Average current consumption: 12V 0,8A, 24V 0,4A.

Consumption: 10W.

Operating temperature: -40 °C to +60 °C.

RF suppression: CISPR 25, class 5 (conducted).

Resistant to high pressure cleaning. Type of protection: IP5KX, IPX4K, IPX9K.

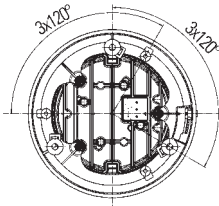
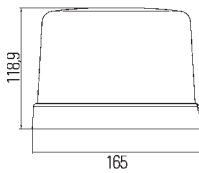

2RL 011 484-121

1

LED beacon,
according to DIN 14 620, shape B1,
with magnetic attachment,
spirally-coiled lead extends up to 2.5 m
and 2-pole plug for connecting,
to the cigarette lighter socket
blue

2RL 011 484-021

1

amber

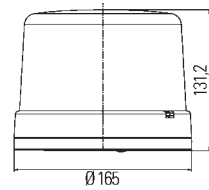

2RL 011 484-111

1

LED beacon,
according to DIN 14 620, shape A,
with tubular fitting for support tube,
blue

2RL 011 484-011

1

amber

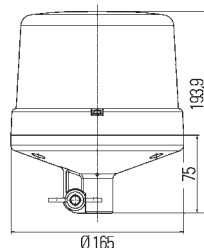

9EL 190 025-011

1

blue

9EL 190 025-001

1

amber

9EL 190 025-021

1

red

Spare parts/Accessories:

Dome,

blue

amber

red

Flashing beacons

K-LED FO

In LED-technology. Clear dome with Fresnel optics. Silver coloured steel base.

Rated voltage: 12V / 24V.

Operating voltage: 10V - 32V.

Average current consumption: 12V 1.5A, 24V 0.8A.

8 strobe frequencies. Power consumption: 20W.

Lens: PC.

Operating temperature: -40 °C to +60 °C.

RF suppression: CISPR 25, class 5 (conducted).

Resistant to high pressure cleaning. Type of protection: IP5K4K, IPX9K.

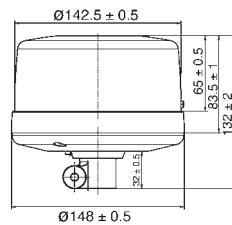
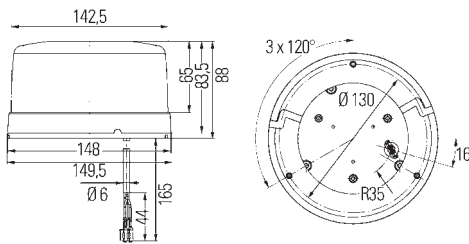

Part no.	Pk.	
2XD 010 311-001	1	LED beacon, amber, according to DIN 14 620, shape B1, for permanent mounting
2XD 010 311-021	1	with magnetic attachment, spirally-coiled lead extends up to 2.5 m and 2-pole plug for connecting to the cigarette lighter socket
2XD 010 311-011	1	LED beacon, amber, according to DIN 14 620, shape A, with tubular fitting for support tube
9EL 174 995-001	1	Spare parts: Dome

Flashing beacons

K-LED 2.0

In LED-technology. With shell reflector and 20 High-Power LEDs. Base made of diecast aluminium.

Rated voltage: 12V / 24V.

Operating voltage: 10V - 32V.

Total current consumption: 0.45A - 2.5A.

Programmable logic for a variety of flash sequences or a rotation function. A sensor automatically adjusts the intensity depending on the ambient light (day/night mode).

Three 6 mm dia. holes for attachment screws.

Power consumption: max. 30W.

Operating temperature range: -40 °C to +60 °C.

Interference suppression: CISPR 25, class 5 (conducted).

Protection rating: IP67.

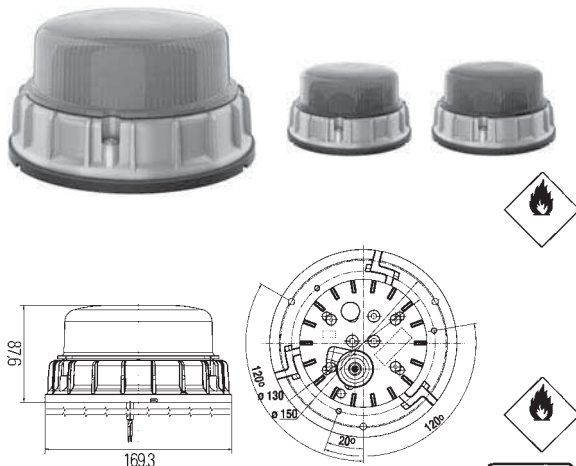

Part no.	Pk.	
		LED beacon, according to DIN 14 620, shape B1, for permanent mounting, with silver coloured base, amber
2XD 011 557-101	1	amber
2XD 011 557-111	1	blue
2XD 011 557-121	1	red
2XD 011 557-131	1	green
		LED beacon, according to DIN 14 620, shape B1, for permanent mounting with a particularly sturdy, amber base, amber
2XD 011 557-001	1	amber
		with 250 mm long lead and 2-pole DEUTSCH plug connector, amber
2XD 011 557-501	1	amber
2XD 011 557-011	1	blue
2XD 011 557-021	1	red
2XD 011 557-031	1	green

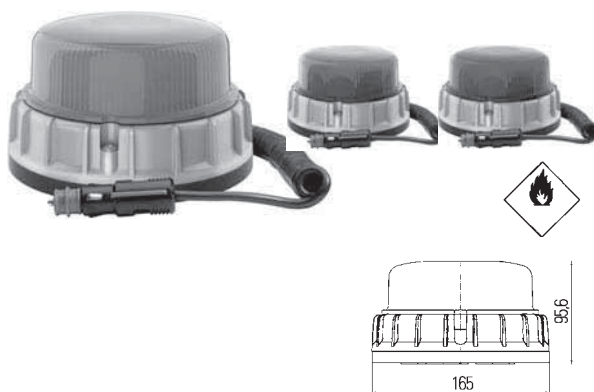

		LED beacon according to DIN 14 620, shape B1, with magnetic attachment, spirally-coiled lead extends up to 2.5 m and 2-pole plug for connecting to the cigarette lighter socket, with silver coloured base, amber
2XD 011 557-301	1	amber
2XD 011 557-311	1	blue
2XD 011 557-321	1	red

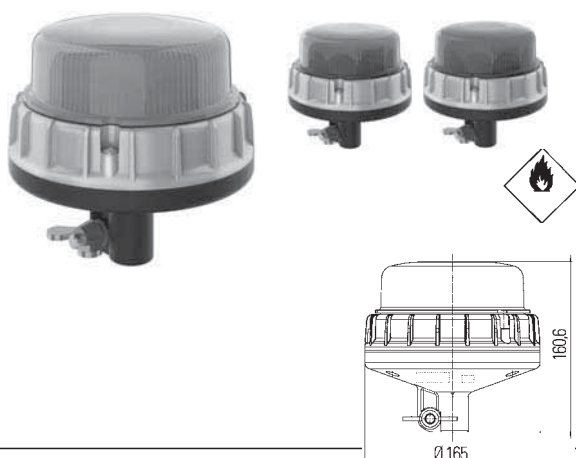

		LED beacon, according to DIN 14 620, shape A, with tubular fitting for support tube and silver coloured base, amber
2XD 011 557-201	1	amber
2XD 011 557-211	1	blue
2XD 011 557-221	1	red

Flashing beacons

In LED-technology. With 8 LEDs, 200 mm long lead with blade receptacles 6.3 mm and polarity reversal protection.

PC dome. PC/ABS body.

Rated voltage: 12V / 24V.

Total power consumption: 0.2A - 0.6A.

Power consumption: 6.0W.

Three 5.5 mm dia. holes for fixing screws.

Operating temperature: -40 °C to +60 °C.

EMC protection: ECE - R10.

Type of protection: IP67 and IPX9K.

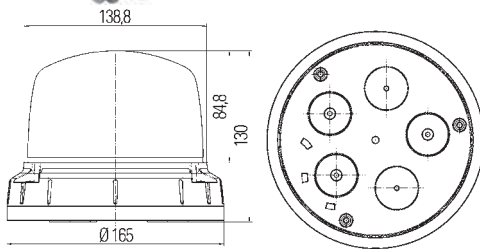
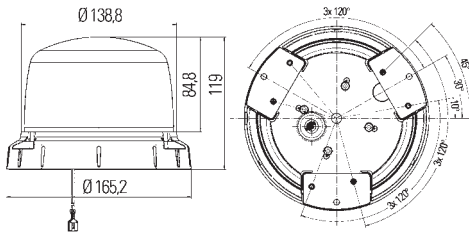

Part no.	Pk.	
2XD 012 480-001	1	LED beacon according to DIN 14 620, shape B1, with three fixing screws PT 4.2 mm dia. for permanent mounting, with black base, amber, 9V - 30V
2XD 012 480-201	1	with black base, amber, 30V - 110V
2XD 012 480-011	1	with black base, red, 9V - 30V
2XD 012 480-311	1	with amber base, red, 9V - 30V
<hr/>		
2XD 012 480-101	1	LED beacon, according to DIN 14 620, shape B1, with magnetic attachment, spirally-coiled lead extends up to 2.5 m and 2-pole plug for connecting to the cigarette lighter socket, with black base, amber, 9V - 30V
2XD 012 480-301	1	with amber body, amber, 9V - 30V
2XD 012 480-111	1	with black base, red, 9V - 30V
2XD 012 480-211	1	with black base, red, 30V - 110V

Mounting bushes

For beacons with tubular fitting.

With built-in electrical socket to DIN 72 591 and rubber protecting cap.



Part no.	Pk.	
8HG 002 365-001	1	For mounting beacon on support at side of vehicle or for welding to a flange, 24 mm dia., approx 100 mm.
8HG 006 294-101	1	Mounting bush, complete
		Mounting bush with separate ground connection
		Spare parts:
8HG 096 531-007	2	Holder for -001
8JB 850 434-011	10	Socket
9GH 096 532-001	10	Rubber protecting cap
8HG 006 294-051	1	Mounting bush with screw fixing
8HG 006 294-091	1	Mounting bush with screw fixing and separate ground connection
8HG 006 294-011	1	Mounting bush
8HG 006 294-021	1	Mounting bush for screwing onto horizontal cabin roofs (on side) with 90 mm mounting bracket
8HG 006 294-111	1	Mounting bush for screwing onto horizontal cabin roofs (on side) with 50 mm mounting bracket
8HG 006 294-131	1	Mounting bush with 90° angle of rotation
8HG 006 294-031	1	Mounting bush, can be swivelled, for screwing onto horizontal and vertical cabin roofs
8HG 006 294-141	1	Mounting bush, can be swivelled, for screwing onto horizontal and vertical cabin roofs (bracket can be adjusted on sloped surfaces)
8HG 006 294-151	1	Mounting bush, can be swivelled, for screwing onto a flat cabin roof (bracket can be adjusted on sloped surfaces)
8HG 006 294-041	1	Length: 1000 mm Extension: up to 700 mm. Telescopic holder for screwing onto back of cabin roof.
8HG 990 368-001	1	Black push-on pipe with thread M8. Mounting bush, for screwing onto horizontal cabin roofs (on top)
8HG 990 368-007	50	
		Spare parts:
8JB 850 434-011	10	Socket
9GH 096 532-001	10	Rubber protecting cap

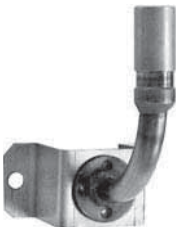



Rubber bases

For mounting on convex mounting surfaces.

Part no.	Pk.	
9GD 860 396-001	1	Rubber base, wedge-shaped, for KL Rotafix
9GD 860 772-001	1	for KL Junior
9GD 862 164-001	5	Rubber spacer for KL/KLX 7000, flat
9GD 863 033-001	1	wedge-shaped

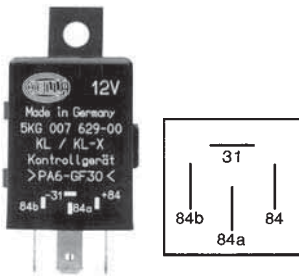

Control units

With contact for control lamp and one beacon.

Part no.	Pk.	
5KG 007 629-001	1	Control unit, 12V
5KG 007 629-011	1	24V



2-pole socket

According to DIN EN ISO 4165. Max. load: 8A at 12V. With cover and two blade terminal contacts 6.3 mm.

Part no.	Pk.	
8JB 004 777-001	5	2-pole socket

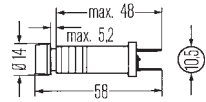

Warning light

For dashboards with thickness of up to 5.2 mm. With blade terminal connections. Dust and waterproof, screw-type fixing.





Part no.	Pk.	
2AA 003 257-031	1	Warning light, amber

Rotating beacons



old-type









Spare parts for old-type rotating beacons

	Rotating beacon	Dome	1) Base 2) Drive belt 3) Base plate		1) Reflector 2) Motor with snap-in fixing		Bulb		
			Pk.	Pk.	Pk.	Pk.		Pk.	
KL 600 	2RL 004 957-001 blue, 12V 2RL 004 957-011 blue, 24V	9EL 856 415-001 blue	1	1) for -101 9BG 859 695-101	1	1) with drive belt 9DX 859 560-001	1	8GH 002 089-133 12V55W (H1)	1
	2RL 004 957-101 amber, 12V 2RL 004 957-111 amber, 24V	9EL 856 416-001 amber	1	for -111 9BG 859 695-111	1	2) with drive belt and reflector 9MN 858 616-001 12V	1	8GH 002 089-251 24V70W (H1)	1
KL 610 	2RL 005 446-00 amber, 12V 2RL 005 446-01 amber, 24V	9EL 856 416-001 amber	1	2) 9XR 854 840-001 (2 pieces)		9MN 858 616-011 24V	1		
KL 700 	2RL 004 958-001 blue, 12V 2RL 004 958-04 blue, 12V 2RL 004 958-011 blue, 24V	9EL 856 417-001 blue	1	1) 9BG 856 420-007	18				
	2RL 004 958-101 amber, 12V 2RL 004 958-14 amber, 12V 2RL 004 958-111 amber, 24V	9EL 856 418-001 amber	1	2) 9XR 854 840-001 (2 pieces)	1				
				3) 9GD 856 562-001	1				
KL 710 	2RL 006 295-001 blue, 12V 2RL 006 295-011 blue, 24V	9EL 856 415-001 blue	1	2) 9XR 854 840-001 (2 pieces)	1				
	2RL 006 295-101 amber, 12V 2RL 006 295-111 amber, 24V	9EL 856 416-001 amber	1	3) 9GD 858 013-001	1				
KL 800 	2RL 004 102-00 blue, 12V 2RL 004 102-01 blue, 24V	9EL 857 801-001 blue	1	2) 9XR 854 840-001 (2 pieces)	1	1) 9DX 859 625-001	1		
	2RL 004 102-10 amber, 12V 2RL 004 102-111 amber, 24V	9EL 857 803-001 amber	1						
		9EL 857 801-011 amber, without optik	1						

Accessories for old-type rotating beacons

	9GD 856 863-001	1	Rubber spacer for KL 700		9GD 859 037-001	1	Rubber spacer for KL 800
	9GD 858 086-001	1	for KL 710				

Spare parts for old-type rotating beacons

	Rotating beacon	Dome	1) Reflector 2) Base plate		Drive belt	Bulb			
			Pk.	Pk.		Pk.	Pk.		
KLJ 60 	2RL 003 134-00 blue, 12V 2RL 003 134-01 blue, 24V	9EL 852 061-001 blue	1	1) 9DX 859 560-001 *)	1	9XR 854 840-001 (2 pieces)	1	8GH 002 089-133 12V55W (H1)	1
	2RL 003 134-12 amber, 12V 2RL 003 134-13 amber, 24V	9EL 854 912-001 amber	1					8GH 002 089-251 24V70W (H1)	1
KLJ 70 	2RL 003 130-08 blue, 12V 2RL 003 130-09 blue, 24V								
	2RL 003 130-12 amber, 12V 2RL 003 130-14 amber, 24V								
KLJ 80 	2RL 003 129-00 blue, 12V 2RL 003 129-01 blue, 24V	9EL 852 820-001 blue	1	1) 9DX 859 625-001 *)	1				
	2RL 003 129-10 amber, 12V 2RL 003 129-11 amber, 24V	9EL 855 097-001 amber	1						
2RL 002 472-... 	2RL 002 472-00 amber, 220V	9EL 854 912-001 amber	1	-	-	Motor with gear unit, 220V/240V 9MN 854 290-001	1	-	-
	2RL 002 472-01 red, 220V								
	2RL 002 472-02 green, 220V								
2RL 005 403-... 	2RL 005 403-00 amber, 220V	9EL 856 418-001 amber	1	2) 9GD 856 562-001	1				
	2RL 005 403-10 red, 220V	9EL 856 418-011 red	1						
2RL 006 811-... 	2RL 006 811-00 amber, 220V	9EL 856 416-001 amber	1	2) 9GD 858 013-001	1				
	2RL 006 811-01 red, 220V	9EL 856 416-011 red	1						



*) If the motor base plate is metal, order reflector and motor (2 parts),
is plastic, order only defective part (reflector or motor)

Flashing beacons



old-type



Spare parts for old-type flashing beacons

	Flashing beacon	Dome	Rubber gasket		Power supply		Xenon strobe with reflector	
			Pk.	Pk.	Pk.	Pk.	Pk.	Pk.
KLX 	2RL 007 017-00 blue, 12V 2RL 007 017-02 blue, 24V	9EL 859 658-001 blue	1	9GD 856 466-001	1	-	-	-
	2RL 007 017-01 amber, 12V 2RL 007 017-03 gelb, 24V	9EL 859 658-011 amber	1					
BSX-Micro 	2XD 008 605-80 blau, 12V 2XD 008 605-81 blau, 24V	-	-	-	-	-	8GS 861 710-001	1

Accessories for old-type flashing beacons

	9GD 856 863-001	1	Rubber gasket		5KG 007 629-001 5KG 007 629-011	1 1	Control unit, 12V 24V
	8HG 005 436-011	1	Holder for tubular fitting				

Flashing beacons

BSX-Micro

Light aperture: 90 x 60 mm.

Technical data:

Rated voltage: 12V / 24V.

Operating voltage: 10V - 15V at 12V, 20V - 30V at 24V.

Strobe frequency: 2.1Hz = approx. 120 double flashes/min.

Electrical strobe power: 2 x (6 + 1.5 Ws).

Power consumption: 3.8A at 12V, 1.8A at 24V.

Operating temperature: -40 °C to +60 °C.

RF suppression: CISPR 25, class 5 (conducted).

Type of protection strobe beacon: resistant to high pressure cleaning.

Type of protection power supply VSE-X: dustproof.

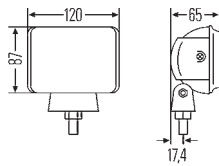
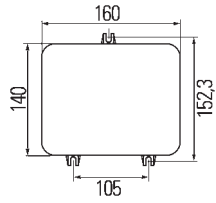

Part no.	Pk.	
		With push-in adapter mounting set. Black plastic body.
2XD 861 423-011	1	Flashing beacon, blue, 12V/24V
		Accessories:
8GS 861 710-001	1	Xenon strobe with reflector
2XD 861 423-021	1	Flashing beacon, amber, 12V/24V
		Accessories:
8GS 861 710-001	1	Xenon strobe with reflector

For flush mounting in the vehicle front.

Amber lens.

With 12 LEDs 3.0W and 2500 mm long lead.

Voltage range: 9V - 33V.

Consumption: 0.13A at 12V/24V.

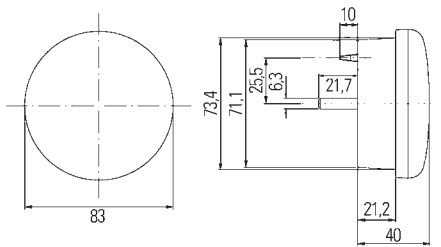

Part no.	Pk.	
2XD 959 011-021	1	LED flashing beacon, amber, 12V/24V

Flashing beacons

BSN-LED

Content: two LED beacons with four Power-LED each and 300 mm long lead with AMP plug.

Clear lens. Light aperture: 122 x 41 mm.

Choice of signals:

- 10 flashing sequences including a random HELLA Random Flash flashing sequence

- synchronous or alternating signal

- 100 Hz permanent signal

Technical data:

Voltage range: 9V - 32V.

Power consumption: 0.8A at 12V, 0.4A at 24V.

Operating temperature: -40 °C to +60 °C.

Type of protection: IP5K4K9K.

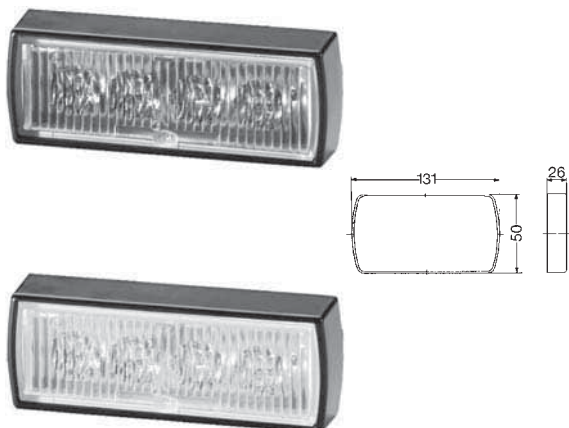

Part no.	Pk.	
		Black metal body. Six holes for fixing screws.
2XD 010 312-801	1	LED flashing beacon set, blue, 12V/24V
2XD 010 312-811	1	LED flashing beacon set, amber, 12V/24V
8HG 184 521-001	1	Accessories: Mounting set for VW T5 10/09->

Flashing beacons

BST

Contents: 2 LED-flashing beacons with each 6 LEDs.
Clear lens.

Choice of signals:

- single flashes
- double flashes
- triple flashes
- quad flashes
- continuous light

Technical data:

Voltage range: 11V - 30V.
Operating temperature: -40 °C to +60 °C.
Overvoltage protection: yes.
Power consumption: blue and white: 13.8W, red: 8.0W.
Aluminium body.
Type of protection: IP6K4K and IP9K.

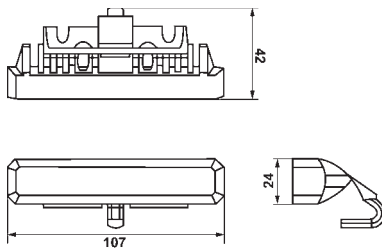
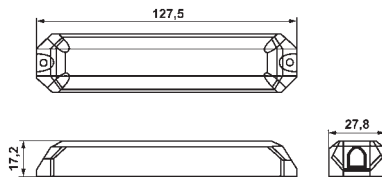

Part no.	Pk.	
		For horizontal surface mounting. With 180 mm long lead and 4-pole AMP plug connector. Two holes for fixing screws.
2XD 012 160-841	1	LED flashing beacon set, blue, 12V/24V
		For horizontal surface mounting. With 200 mm long lead. Two holes for fixing screws.
2XD 012 160-801	1	LED flashing beacon set, blue, 12V/24V
2XD 012 160-851	1	LED flashing beacon set, amber, 12V/24V
2XD 012 160-871	1	LED flashing beacon set, white, 12V/24V
2XD 012 160-821	1	LED flashing beacon set, red, 12V/24V
		With bracket for horizontal flush mounting and 970 mm long lead.
2XD 012 160-811	1	LED flashing beacon set, blue, 12V/24V
2XD 012 160-861	1	LED flashing beacon set, amber, 12V/24V
2XD 012 160-881	1	LED flashing beacon set, white, 12V/24V
2XD 012 160-831	1	LED flashing beacon set, red, 12V/24V

Flashing beacons

BST

Contents: 2 LED-flashing beacons with each 6 LEDs.
Clear lens.

Choice of signals:

- single flashes
- double flashes
- triple flashes
- quad flashes
- continuous light

Technical data:

Voltage range: 11V - 30V.
Operating temperature: -40 °C to +60 °C.
Overvoltage protection: yes.
Power consumption: blue and white: 13.8W, amber: 9.6W.
Aluminium body.
Type of protection: IP6K4K and IP9K.

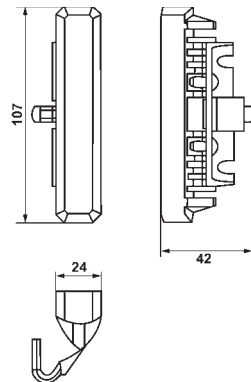
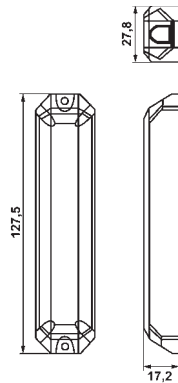

Part no.	Pk.	
		For vertical surface mounting. With 200 mm long lead. Two holes for fixing screws.
2XD 012 160-901	1	LED flashing beacon set, blue, 12V/24V
2XD 012 160-951	1	LED flashing beacon set, amber, 12V/24V
2XD 012 160-971	1	LED flashing beacon set, white, 12V/24V
		With bracket for vertical flush mounting and 970 mm long lead.
2XD 012 160-911	1	LED flashing beacon set, blue, 12V/24V
2XD 012 160-961	1	LED flashing beacon set, amber, 12V/24V
2XD 012 160-981	1	LED flashing beacon set, white, 12V/24V

Rear warning lights WL-LED

In the colours amber, red, white and green, the rear warning lights does not have en ECE type approval

With 12 LEDs. Clear lens.

Up to 8 strobe sequences can be coded, synchronous as well as alternating, for synchronisation of 2, 3 or 4 lamps.

Technical data:

Rated voltage: 12V / 24V.

Operating voltage: 10V - 15V at 12V, 20V -30V at 24V.

Power consumption: 0.7A at 12V, 0.35A at 24V.

Strobe frequency: 2.0Hz.

Polarity reversal protection: yes.

Operating temperature: -40 °C to +60 °C.

RF suppression: CISPR 25, class 5 (conducted).

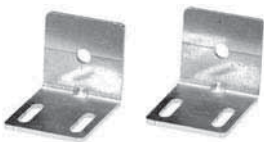
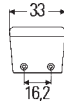
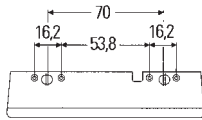
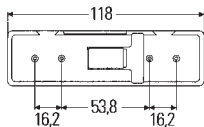

Part no.	Pk.	
2XD 008 997-001	1	Rear warning light without mounting frame, blue, 12V
2XD 009 048-001	1	blue, 24V
2XD 008 997-011	1	amber, 12V
2XD 009 048-011	1	amber, 24V
2XD 008 997-021	1	red, 12V
2XD 009 048-021	1	red, 24V
2XD 008 997-251	1	white, 12V
2XD 009 048-251	1	white, 24V
2XD 008 997-231	1	green, 12V
<hr/>		
2XD 008 997-201	1	Rear warning light with mounting frame, blue, 12V
2XD 009 048-201	1	blue, 24V
2XD 008 997-211	1	amber, 12V
2XD 009 048-211	1	amber, 24V
2XD 008 997-221	1	red, 12V
2XD 009 048-221	1	red, 24V
2XD 008 997-261	1	white, 12V
2XD 009 048-261	1	white, 24V
2XD 008 997-241	1	green, 12V
Accessories:		
9XD 863 533-001	1	Angular bracket (2 pcs.) including 4 screws
9XD 863 828-001	1	Built-in frame of black coated aluminium, adjustable bracket, including 4 screws



Rear warning lights

C-LED

Corner light for installation in pairs at the vehicle rear. In connection with two blue beacons in the front area, the C-LED corner light system achieves a 360° all-around warning effect.

Technical data:

Rated voltage: 12V / 24V.
 Operating voltage: 12V - 30V at 12V, 18V - 32V at 24V.
 Power consumption: (each C-LED modul)
 300 mA at 12V, 150 mA at 24V.
 Operating temperature: -40 °C to +60 °C.
 RF suppression: CISPR 25, class 5 (conducted).
 Resistant to high pressure cleaning.

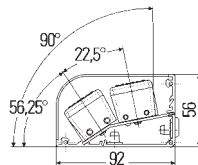
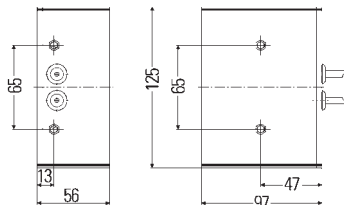
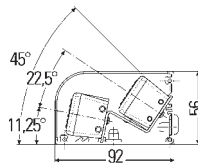
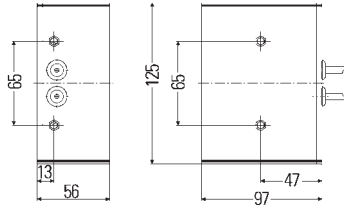
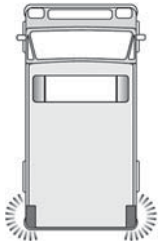

Part no.	Pk.	
Installation variant 1. With blue PC lens and 24 LEDs. Silver coloured aluminium body.		
2XD 009 475-021	1	LED rear warning light, blue, 12V
2XD 009 475-001	1	LED rear warning light, blue, 24V
Installation variant 2. With 24 LEDs, blue PC lens and Silver coloured aluminium body.		
2XD 009 475-031	1	LED rear warning light, blue, 12V
2XD 009 475-011	1	LED rear warning light, blue, 24V
Accessories: Control unit, 12V / 24V (one control unit is necessary for every C-LED corner light)		
5KG 009 713-001	1	



C-LED Modul

Single component for vertical, installation in pairs at the vehicle rear (4 C-LED modules are required).

Please observe defined angle arrangement.

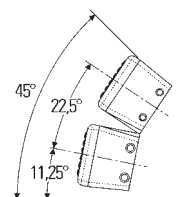
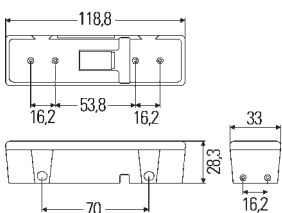

Part no.	Pk.	
With 24 LEDs. Clear lens. Black plastic body.		
2XD 008 997-101	1	LED rear warning light, blue, 12V
2XD 009 048-101	1	LED rear warning light, blue, 24V
Accessories: Control unit, 12V / 24V, one control unit is necessary for every 2 C-LED modules Switch with warning light for connection to the control unit		
5KG 009 713-001	1	
6ED 004 778-001	1	

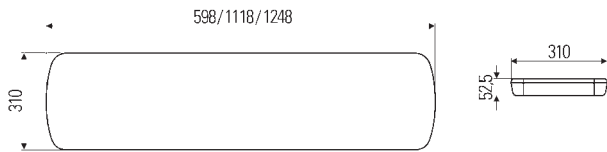

Optical warning systems Raptor with LED trough module system, 598 mm, 1118 mm, 1248 mm

For medium-sized to large special-purpose vehicles.
With clear PC dome and 8 LED modules.

Aluminium base plate.

Technical data:

Rated voltage: 12V.

Operating voltage range: 9V - 16V.

Average current consumption: 1.2A.

Flashing sequence: double.

Operating temperature: - 20 °C to + 60 °C.

RF suppression: CISPR 25, class 5 (conducted).

EMC protection. Type of protection: IP5K4K and IPX9K.

Part no.	Pk.	
2RL 010 743-001	1	Optical warning system Raptor (LED Signal Bar), 598 mm, amber, 12V
2RL 010 743-141	1	blue, 12V
<hr/>		
2RL 010 743-091	1	Optical warning system Raptor (LED Signal Bar), 1118 mm, amber, 12V
2RL 010 743-011	1	blue, 12V
<hr/>		
2RL 010 743-041	1	Optical warning system Raptor (LED Signal Bar), 1118 mm, with rear LED moving light signal (LSB), amber, 12V
<hr/>		
2RL 010 743-051	1	Optical warning system Raptor (LED Signal Bar), 1118 mm, with two side-mounted lights incl. LEDs, amber, 12V
2RL 010 743-101	1	blue, 12V
<hr/>		
2RL 010 743-061	1	Optical warning system Raptor (LED Signal Bar), 1118 mm, with rear LED moving light signal (LSB) and two side-mounted lights incl. LEDs, amber, 12V
2RL 010 743-111	1	blue, 12V
<hr/>		
2RL 010 743-021	1	Optical warning system Raptor (LED Signal Bar), 1248 mm, amber, 12V
2RL 010 743-151	1	blue/red, 12V
<hr/>		
2RL 010 743-031	1	Optical warning system Raptor (LED Signal Bar), 1248 mm, with rear LED moving light signal (LSB), amber, 12V
<hr/>		
2RL 010 743-071	1	Optical warning system Raptor (LED Signal Bar), 1248 mm, with two side-mounted lights incl. LEDs, amber, 12V
2RL 010 743-121	1	blue, 12V
<hr/>		
2RL 010 743-081	1	Optical warning system Raptor (LED Signal Bar), 1248 mm, with rear LED moving light signal (LSB) and two side-mounted lights incl. LEDs, amber, 12V
2RL 010 743-131	1	blue, 12V



Control unit

Part no.	Pk.	
9SX 178 258-001	1	Control unit for LED moving light signal (LSB)

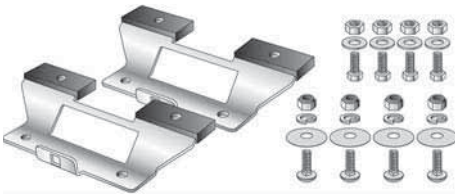

Bracket for four-point fixing

Contents:

2 brackets made of stainless steel with fixing material

Part no.	Pk.	
8HG 168 011-001	1	Bracket for four-point fixing

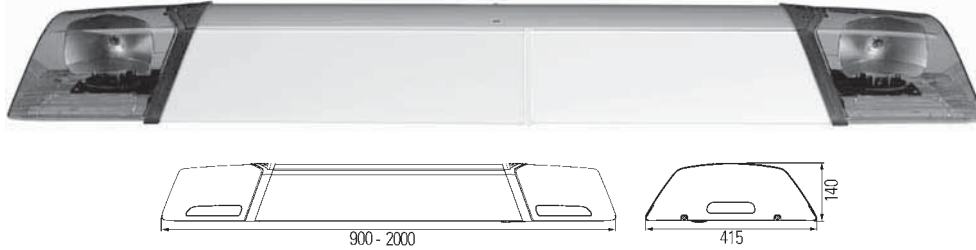

Optical warning systems OWS 7 with single reflector system KL-ER, 900 mm, 1000 mm, 1100 mm, 1200 mm, 1300 mm, ...,

For medium-sized to large special-purpose vehicles.
With two amber PC domes and H1 bulbs. Light aperture (reflector dia.): 84 mm.

Modular design with a length range from 900 mm to a possible 2000 mm.
As auxiliary lighting systems, adjustable with two LED side-mounted lights for side illumination or integrated H3 worklights (facing the front or rear) can be optionally selected.

Technical data:

Rated voltage: 12V / 24V. Operating voltage range: 10.8V - 13.8V at 12V, 21.6V - 27.6 at 24V.

Power consumption of rotating beacons: 9.4A at 12V.

Belt drive: n = 160 rpm.

Operating temperature: - 40 °C to + 60 °C.

RF suppression: CISPR 25, class 5 (conducted).

Resistant to high pressure cleaning. Weight: max. 25 kg.

Part no.	Pk.	
2RL 010 710-101	1	Optical warning system OWS 7 with single reflector system KL-ER, 900 mm, amber, 12V
2RL 010 710-471	1	amber, 12V, with backlighting of white advertising area at the front and back *)
<hr/>		
2RL 010 710-111	1	Optical warning system OWS 7 with single reflector system KL-ER, 1000 mm, amber, 12V
2RL 010 710-901	1	amber (clear domes), 12V, with backlighting of white advertising area at the front and back *)
<hr/>		
2RL 010 710-121	1	Optical warning system OWS 7 with single reflector system KL-ER, 1100 mm, amber, 12V
2RL 010 710-211	1	amber, 12V, with two side-mounted lights incl. LEDs
2RL 010 711-871	1	amber, 12V, with two side-mounted lights incl. LEDs, special colour panels to the front and back clear
<hr/>		
2RL 010 711-661	1	Optical warning system OWS 7 with single reflector system KL-ER, 1200 mm, amber, 12V, with two H3 work lights incl. bulbs to the back and LSB (LED Signal Bar to hedge to the back), special colour panel to the back clear
2RL 010 711-741	1	amber, 12V, with backlighting of white advertising area at the front and back *)
2RL 010 711-811	1	amber, 12V, special colour panels to the front and back clear
<hr/>		
2RL 010 711-861	1	Optical warning system OWS 7 with single reflector system KL-ER, 1300 mm, amber, 12V
<hr/>		
Spare parts/Accessories:		
9EL 172 563-221	1	Dome, amber, without outcut
9EL 172 563-321	1	with outcut
Reflector		
2RL 864 233-101	1	with 12V bulb
2RL 864 233-111	1	with 24V bulb
H1 bulb,		
8GH 002 089-133	1	12V55W
8GH 002 089-251	1	24V70W
2XD 176 235-001	1	Alley Light (LED side-mounted light), 12V
1GA 010 467-001	1	H3 work light, 12V
9DW 168 426-811	1	LED Signal Bar
Panel for OWS 1000 mm,		
9EL 174 215-011	1	white
9EL 174 214-011	1	clear
Panel for OWS 1100 mm,		
9EL 172 564-011	1	white
9EL 172 564-101	1	clear

*) In Germany, Austria and Switzerland not approved

Optical warning system OWS 7 with single reflector system KL-ER, 1400 mm,

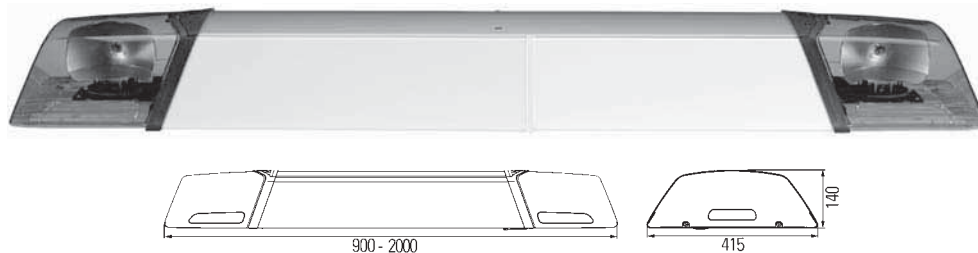

Optical warning systems OWS 7 with single reflector system KL-ER, ..., 1400 mm, 1600 mm, 1800 mm, 2000 mm

For medium-sized to large special-purpose vehicles.
With two amber PC domes and H1 bulbs. Light aperture (reflector dia.): 84 mm.

Modular design with a length range from 900 mm to a possible 2000 mm.
As auxiliary lighting systems, adjustable with two LED side-mounted lights for side illumination, integrated H3 worklights (facing the front or rear) or amber indicator lights can be optionally selected.

Technical data:

Rated voltage: 12V / 24V. Operating voltage range: 10.8V - 13.8V at 12V, 21.6V - 27.6 at 24V.

Power consumption of rotating beacons: 9.4A at 12V.

Belt drive: n = 160 rpm.

Operating temperature: - 40 °C to + 60 °C.

RF suppression: CISPR 25, class 5 (conducted).

Resistant to high pressure cleaning. Weight: max. 25 kg.

Part no.	Pk.	
2RL 010 710-131	1	Optical warning system OWS 7 with single reflector system KL-ER, 1400 mm, amber, 12V
2RL 010 711-691	1	amber, 12V, special colour panels to the front and back clear
2RL 010 710-221	1	amber, 12V, with two side-mounted lights incl. LEDs
2RL 010 711-671	1	amber, 12V, with two side-mounted lights incl. LEDs, each two H3 work lights to the front and back and LSB (LED Signal-Bar to hedge to the back), special colour panels to the front and back clear
2RL 010 711-851	1	amber, 12V, with two side-mounted lights incl. LEDs, two H3 work lights to the back and LSB (LED Signal-Bar to hedge to the back), special colour panel to the back clear
2RL 010 711-951	1	amber, 12V, with two side-mounted lights incl. LEDs, two H3 work lights incl. bulbs to the back, amber indicator lights to the front and back and LSB (LED Signal Bar to hedge to the back), special colour panel to the front white, to the back clear, with backlighting of white advertising area at the front *)
2RL 010 710-741	1	amber, 24V
2RL 010 711-291	1	amber, 24V, with two H3 work lights incl. bulbs to the back, special colour panels to the front and back clear
<hr/>		
2RL 010 710-141	1	Optical warning system OWS 7 with single reflector system KL-ER, 1600 mm, amber, 12V
2RL 010 710-791	1	amber, 24V
2RL 010 711-941	1	amber, 24V, with two H3 work lights incl. bulbs each to the front, special colour panels to the front and back clear
<hr/>		
2RL 010 710-841	1	Optical warning system OWS 7 with single reflector system KL-ER, 1800 mm, amber, 24V
2RL 010 710-921	1	amber, 24V, with two H3 work lights incl. bulbs to the back
<hr/>		
2RL 010 711-321	1	Optical warning system OWS 7 with single reflector system KL-ER, 2000 mm, amber, 24V
2RL 010 711-761	1	amber, 24V, with two side-mounted lights incl. LEDs, two H3 work lights incl. bulbs each to the front and each to the back, amber indicator lights to the front and back and LSB (LED Signal Bar to hedge to the back), special colour panels to the front and back clear
<hr/>		
Spare parts/Accessories:		
9EL 172 563-221	1	Dome, amber, without cutout
9EL 172 563-321	1	with cutout
2RL 864 233-101	1	Reflector with 12V bulb
2RL 864 233-111	1	with 24V bulb
8GH 002 089-133	1	H1 bulb, 12V55W
8GH 002 089-251	1	24V70W
2XD 176 235-001	1	Alley Light (LED side-mounted light), 12V
1GA 010 467-001	1	H3 work light, 12V
9DW 168 426-801	1	Indicator light set, amber
9DW 168 426-811	1	LED Signal Bar

*) In Germany, Austria and Switzerland not approved

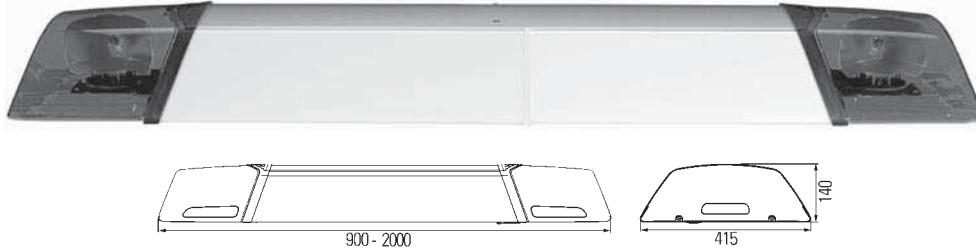

**OWS 7 Optical warning systems KL-ER,
1000 mm, 1100 mm, 1200 mm, 1400 mm, 1500 mm**

**For medium-sized to large special-purpose vehicles.
With two blue PC domes and H1 bulbs.
Light aperture (reflector dia.): 84 mm.**

Modular design with a length range from 900 mm to a possible 2000 mm.
As auxiliary lighting systems, adjustable with two LED side-mounted lights for side illumination or integrated H3 worklights (facing the front or rear) can be optionally selected.

Technical data:

Rated voltage: 12V / 24V. Operating voltage range: 10.8V - 13.8V at 12V, 21.6V - 27.6 at 24V.

Power consumption of rotating beacons: 9.4A at 12V.

Belt drive: n = 160 rpm.

Operating temperature: - 40 °C to + 60 °C.

RF suppression: CISPR 25, class 5 (conducted).

Resistant to high pressure cleaning. Weight: max. 25 kg.

Part no.	Pk.	
2RL 010 713-211	1	Optical warning system OWS 7 with single reflector system KL-ER, 1000 mm, blue, 12V
2RL 010 713-111	1	blue, 12V, with stop signal ASG-Matrix
<hr/>		
2RL 010 713-171	1	Optical warning system OWS 7 with single reflector system KL-ER, 1100 mm, blue, 12V
<hr/>		
2RL 010 713-161	1	Optical warning system with single reflector system KL-ER, 1200 mm, blue, 12V
<hr/>		
2RL 010 713-231	1	Optical warning system OWS 7 with single reflector system KL-ER, 1400 mm, blue, 12V
2RL 010 713-511	1	blue, 24V, special colour panels to the front and back clear
<hr/>		
2RL 010 713-091	1	Optical warning system OWS 7 with single reflector system KL-ER, 1500 mm, blue, 12V, with two H3 work lights incl. bulbs to the back and LSB (LED Signal Bar to hedge to the back)
<hr/>		
Spare parts/Accessories:		
9EL 172 563-001	1	Dome, blue, without outcut
		Reflector
2RL 864 233-001	1	with 12V bulb
8GH 002 089-133	1	H1 bulb, 12V55W
1GA 010 467-001	1	H3 work light, 12V
9DW 168 426-811	1	LED Signal Bar
		Panel for OWS 1000 mm,
9EL 174 215-011	1	white
9EL 174 214-011	1	clear
		Panel for OWS 1100 mm,
9EL 172 564-011	1	white
9EL 172 564-101	1	clear

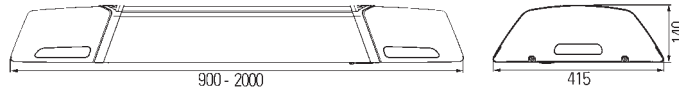

Optical warning systems OWS 7 with LED trough module system KL-LR2, 900 mm, 1000 mm, 1100 mm, 1200 mm ...

For medium-sized to large special-purpose vehicles.
With two amber PC domes and 2 x 2 reflectors with 30 amber LEDs.

Modular design with length variance from 900 mm to 2000 mm at 100 mm intervals.
As additional lighting systems, adjustable headlights "Alley Lights", integrated work lights (to front or rear), amber indicator lights, stop signal generator or LED signal bar can optionally be selected.

Technical data:

Rated voltage: 12V.

Operating temperature: -40 °C to +60 °C.

RF suppression: CISPR 25, class 3 (conducted).

Resistant to high-pressure jet cleaners. Weight: max. 25 kg depending on features.

Part no.	Pk.	
2RL 010 710-151	1	Optical warning system OWS 7 with LED trough module system KL-LR2, 900 mm, amber, 12V
2RL 010 710-911	1	amber, 12V, with two amber indicator lights to the back
<hr/>		
Optical warning system OWS 7 with LED trough module system KL-LR2, 1000 mm, amber, 12V		
2RL 010 710-161	1	amber, 12V
2RL 010 710-891	1	amber (clear domes), 12V, with backlighting of white advertising area at the front and back *)
2RL 010 710-311	1	amber, 12V, with backlighting of white advertising area at the front and back *)
2RL 010 710-231	1	amber, 12V, with two side-mounted lights incl. LEDs
2RL 010 711-371	1	amber, 12V, with two side-mounted lights incl. LEDs, two H3 work lights incl. bulbs to the back, special colour panel to the back clear
2RL 010 711-531	1	amber, 12V, with two H3 work lights incl. bulbs each to the front and each to the back, special colour panels to the front and back clear
2RL 010 710-041	1	amber (clear domes), 12V, with two work lights incl. LEDs each to the front and each to the back
<hr/>		
Optical warning system OWS 7 with LED trough module system KL-LR2, 1100 mm, amber, 12V		
2RL 010 710-171	1	amber, 12V
2RL 010 710-241	1	amber, 12V, with two side-mounted lights incl. LEDs
2RL 010 710-021	1	amber, 12V, with two H3 work lights incl. bulbs to the back
2RL 010 710-261	1	amber, 12V, with two side-mounted lights incl. LEDs, two H3 work lights incl. bulbs to the back and LSB (LED Signal-Bar to hedge to the back), special colour panel to the back clear
2RL 010 710-881	1	amber (clear domes), 12V, with two H3 work lights incl. bulbs each to the front and each to the back
2RL 010 710-071	1	amber (clear domes), 12V, with two side-mounted lights incl. LEDs and two work lights incl. LEDs each to the front and each to the back
<hr/>		
Optical warning system OWS 7 with LED trough module system KL-LR2, 1200 mm, amber (clear domes), 12V, with two H3 work lights incl. bulbs to the back		
2RL 010 710-061	1	amber (clear domes), 12V, with two H3 work lights incl. bulbs to the back
2RL 010 710-391	1	amber, 12V, with backlighting of white advertising area at the front and back
2RL 010 711-231	1	amber, 12V, with two side-mounted lights incl. LEDs, one H3 work light incl. bulb to the back, amber indicator lights to the front and back and LSB (LED Signal-Bar to hedge to the back)
2RL 010 711-561	1	amber, 12V, with two side-mounted lights incl. LEDs and two H3 work lights incl. bulbs to the back, special colour panel to the front clear
<hr/>		
Spare parts/Accessories:		
		Dome, amber,
9EL 172 563-251	1	without output
9EL 172 563-351	1	with cutout
2XD 171 067-051	1	LED flashing beacon module, amber, 12V
2XD 176 235-001	1	Alley Light (LED side-mounted light), 12V
1GA 010 467-001	1	H3 work light, 12V
9DW 168 426-811	1	LED Signal Bar
		Panel for OWS 1000 mm,
9EL 174 215-011	1	white
9EL 174 214-011	1	clear
		Panel for OWS 1100 mm,
9EL 172 564-011	1	white
9EL 172 564-101	1	clear

*) In Germany, Austria and Switzerland not approved

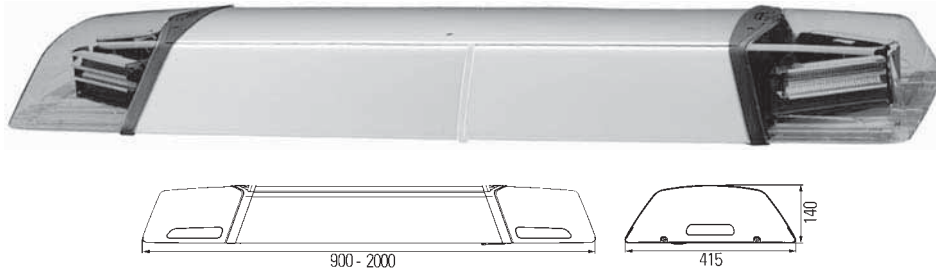

Optical warning systems OWS 7 with LED trough module system KL-LR2, ..., 1300 mm, 1400 mm, 1600 mm, 1800 mm

For medium-sized to large special-purpose vehicles.
With two amber PC domes and 2 x 2 reflectors with 30 amber LEDs.

Modular design with a length range from 900 mm to a possible 2000 mm at 100 mm intervals. As auxiliary lighting systems, adjustable with two LED side-mounted lights for side illumination or integrated worklights (facing the front or rear), amber indicator lights, stop signal generator or LED Signal Bar can be optionally selected.

Technical data:

Rated voltage: 12V. Operating temperature: - 40 °C to + 60 °C.

RF suppression: CISPR 25, class 3 (conducted).

Resistant to high pressure cleaning. Weight: max. 25 kg.

Part no.	Pk.	
2RL 010 710-011	1	Optical warning system OWS 7 with LED trough module system KL-LR2, 1300 mm, amber, 12V, with two H3 work lights incl. bulbs to the back and LSB (LED Signal Bar to hedge to the back)
2RL 010 711-681	1	amber, 12V, with two side-mounted lights incl. LEDs and two H3 work lights to the back, special colour panel to the back clear
2RL 010 710-181	1	Optical warning system OWS 7 with LED trough module system KL-LR2, 1400 mm, amber, 12V
2RL 010 711-831	1	amber (clear domes), 12V
2RL 010 710-941	1	amber, 12V, with backlighting of white advertising area at the front and back *)
2RL 010 710-251	1	amber, 12V, with two side-mounted lights incl. LEDs
2RL 010 710-031	1	amber, 12V, with two side-mounted lights incl. LEDs and two H3 work lights to the front
2RL 010 710-051	1	amber, 12V, with two H3 work lights to the front
2RL 010 710-561	1	amber, 24V
2RL 010 710-191	1	Optical warning system OWS 7 with LED trough module system KL-LR2, 1600 mm, amber, 12V
2RL 010 710-631	1	amber, 24V
2RL 010 710-261	1	amber, 12V, with two side-mounted lights incl. LEDs
2RL 010 710-281	1	amber, 12V, with two side-mounted lights incl. LEDs and two H3 work lights incl. bulbs to the back
2RL 010 710-851	1	amber, 24V, with two side-mounted lights incl. LEDs and two H3 work lights incl. bulbs to the back
2RL 010 710-871	1	amber, 24V, with two side-mounted lights incl. LEDs and four H3 work lights incl. bulbs to the front
2RL 010 710-701	1	Optical warning systems OWS 7 with LED trough module system KL-LR2, 1800 mm, amber, 24V
		Spare parts:
9EL 172 563-251	1	Dome, amber, without output
9EL 172 563-351	1	Dome, amber, with output
2XD 171 067-051	1	LED flashing beacon module, amber, 12V
2XD 176 235-001	1	Alley Light (LED side-mounted light), 12V
1GA 010 467-001	1	H3 work light, 12V
9DW 168 426-811	1	LED Signal Bar

*) In Germany, Austria and Switzerland not approved

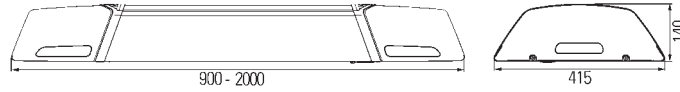

Optical warning systems OWS 7 with LED trough module system KL-LR2, 1000 mm, 1200 mm, 1300 mm, 1400 mm, 1500 mm, 1600 mm

For medium-sized to large special-purpose vehicles.
With two blue PC domes and 2 x 2 reflectors with 24 LEDs for blue light.

Modular design with a length range from 900 mm to a possible 2000 mm.
As auxiliary lighting systems, adjustable with two LED side-mounted lights for side illumination or integrated H3 worklights (facing the front or rear) amber indicators can be optionally selected.

Technical data:
Rated voltage: 12V. Operating temperature: - 40 °C to + 60 °C.
RF suppression: CISPR 25, class 3 (conducted).
Resistant to high pressure cleaning. Weight: max. 25 kg.

Part no.	Pk.	
2RL 010 713-001	1	Optical warning system OWS 7 with LED trough module system KL-LR2, 1000 mm, blue, 12V
2RL 010 713-341	1	Optical warning system OWS 7 with LED trough module system KL-LR2, 1200 mm, blue, 12V, with amber indicator lights to the front and back, synchronized
2RL 010 713-351	1	blue, 12V, with amber indicator lights to the front and back
2RL 010 713-101	1	Optical warning system OWS 7 with LED trough module system KL-LR2, 1300 mm, blue, 12V, with two H3 work lights incl. bulbs to the back and LSB (LED Signal Bar to hedge to the back)
2RL 010 713-011	1	Optical warning system OWS 7 with LED trough module system KL-LR2, 1400 mm, blue, 12V, with two side-mounted lights incl. LEDs, stop signal ASG-Matrix and LSB (LED Signal Bar to hedge to the back), for VW T5
2RL 010 713-021	1	blue, 12V, with two side-mounted lights incl. LED's and ASG-Matrix
2RL 010 713-041	1	blue, 12V, with stop signal ASG-Matrix and LSB (LED Signal Bar to hedge to the back)
2RL 010 713-051	1	blue, 12V, with two H3 work lights incl. bulbs to the back and LSB (LED Signal Bar to hedge to the back)
2RL 010 713-061	1	blue, 12V, with two side-mounted lights incl. LEDs and LSB (LED Signal Bar to hedge to the back)
2RL 010 713-071	1	blue, 12V, with two side-mounted lights incl. LEDs and amber indicator lights to the back
2RL 010 713-081	1	blue, 12V, with one H3 work light incl. bulb to the back
2RL 010 713-121	1	blue, 12V, with two side-mounted lights incl. LEDs, one H3 work light incl. bulb to the back and amber indicator lights to the back
2RL 010 713-151	1	blue, 12V, with two H3 work lights incl. bulbs to the back and LSB (LED Signal Bar to hedge to the back)
2RL 010 713-031	1	Optical warning system OWS 7 with LED trough module system KL-LR2, 1500 mm, blue, 12V, with two H3 work lights incl. bulbs to the back and LSB (LED Signal Bar to hedge to the back)
2RL 010 713-251	1	Optical warning system OWS 7 with LED trough module system KL-LR2, 1600 mm, blue, 12V, with one H3 work light incl. bulb to the back and LSB (LED Signal Bar to hedge to the back)
		Spare parts/Accessories:
9EL 172 563-011	1	Dome, blue, without output
9EL 172 563-111	1	without output
2XD 171 067-251	1	LED flashing beacon module, blue, 12V
2XD 176 235-001	1	Alley Light (LED side-mounted light), 12V
1GA 010 467-001	1	H3 work light, 12V
9DW 168 426-801	1	Indicator light set, amber
9DW 168 426-811	1	LED Signal Bar
9EL 174 215-011	1	Panel for OWS 1000 mm, white
9EL 174 214-011	1	clear

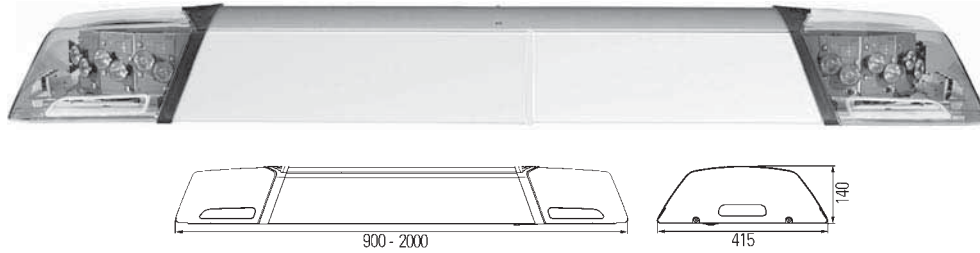

Optical warning systems OWS 7 with LED 2-level module system KL-LM2 (day/night switching system), 900 mm, 1000 mm, ...

For medium-sized to large special-purpose vehicles.

With two amber PC domes and 16 high-performance LEDs in each case, with direct emission for longer flash at daylight.

Modular design with length variance from 900 mm to 2000 mm at 100 mm intervals.

As additional lighting systems, adjustable headlights "Alley Lights", integrated work lights (to front or rear), amber indicator lights, stop signal generator or LED signal bar can optionally be selected.

Technical data:

Rated voltage: 12V/24V.

Current consumption of the module equipment: KL-LM2 (2 levels day): 2.7A.

Power consumption (2 levels day): 36W.

Operating temperature: -40 °C to +60 °C. RF suppression: CISPR 25, class 3 (conducted).

Resistant to high-pressure jet cleaners. Weight: max. 25 kg depending on features.

Part no.	Pk.	
2RL 010 710-961	1	Optical warning system OWS 7 with LED 2-level module system KL-LM2, 900 mm, amber, 12V, with two side-mounted lights incl. LEDs
2RL 010 710-971	1	Optical warning system OWS 7 with LED 2-level module system KL-LM2, 1000 mm, amber, 12V
2RL 010 710-981	1	amber, 12V, with two side-mounted lights incl. LEDs
2RL 010 710-991	1	amber, 12V, with two side-mounted lights incl. LEDs and LSB (LED Signal-Bar to hedge to the back)
2RL 010 711-331	1	amber, 12V, with two side-mounted lights incl. LEDs, amber indicator lights to the front and back and backlighting of white advertising area at the front and back *)
2RL 010 711-931	1	amber, 12V, with two side-mounted lights incl. LEDs, amber indicator lights to the front and back and LSB (LED Signal Bar to hedge to the back), special colour panels to the front and back clear
Spare parts/Accessories:		
9EL 172 563-251	1	Dome, amber, without outcut
9EL 172 563-351	1	with outcut
9EL 172 563-241	1	Dome, clear
9MK 181 350-101	1	LED PCB, white
2XD 176 235-001	1	Alley Light (LED side-mounted light), 12V
9DW 168 426-801	1	Indicator light set, amber
9DW 168 426-811	1	LED Signal Bar
9EL 174 215-011	1	Panel for OWS 1000 mm, white
9EL 174 214-011	1	clear

*) In Germany, Austria and Switzerland not approved

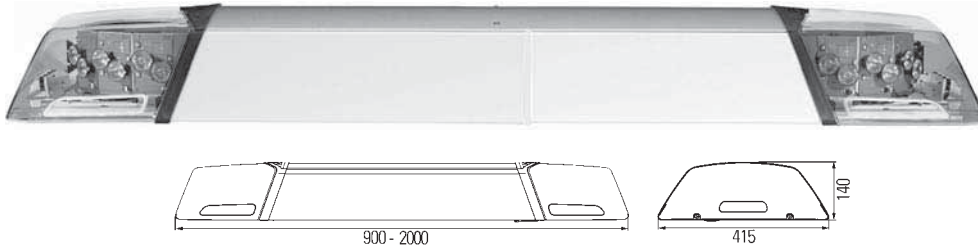

Optical warning systems OWS 7 with LED 2-level module system KL-LM2 (day/night switching system), ..., 1100 mm, ...

**For medium-sized to large special-purpose vehicles.
With two amber PC domes and 16 high-performance LEDs in each case, with direct emission for longer flash at daylight.**

Modular design with length variance from 900 mm to 2000 mm at 100 mm intervals.
As additional lighting systems, adjustable headlights "Alley Lights", integrated work lights (to front or rear), amber indicator lights, stop signal generator or LED signal bar can optionally be selected.

Technical data:
Rated voltage: 12V/24V.
Current consumption of the module equipment: KL-LM2 (2 levels day): 2.7A.
Power consumption (2 levels day): 36W.
Operating temperature: -40 °C to +60 °C. RF suppression: CISPR 25, class 3 (conducted).
Resistant to high-pressure jet cleaners. Weight: max. 25 kg depending on features.

Part no.	Pk.	
2RL 010 711-001	1	Optical warning system OWS 7 with LED 2-level module system KL-LM2, 1100 mm, amber, 12V
2RL 010 711-411	1	amber, 12V, with two side-mounted lights incl. LEDs, two work lights incl. LEDs each to the front and each to the back, two stop signals ASG-Matrix each to the front and each to the back and LSB (LED Signal Bar to hedge to the back), special colour panels to the front and back clear
2RL 010 711-011	1	amber, 12V, with two side-mounted lights incl. LEDs
2RL 010 711-021	1	amber, 12V, with two side-mounted lights incl. LEDs and LSB (LED Signal-Bar to hedge to the back), special colour panel to the back clear
2RL 010 711-381	1	amber, 12V, with backlighting of white advertising area at the front and back
2RL 010 711-391	1	amber, 12V, with two side-mounted lights incl. LEDs, two H3 work lights incl. bulbs to the back, two LED worklights incl. LEDs to the front and LSB (LED Signal Bar to hedge to the back), special colour panel to the front yellow, to the back clear
2RL 010 711-511	1	amber, 12V, with two H3 work lights incl. bulbs to the back and LSB (LED Signal Bar to hedge to the back), special colour panel to the back clear
2RL 010 711-641	1	amber, 12V, with two side-mounted lights incl. LED's, two H3 work lights incl. bulbs each to the front and each to the back and LSB (LED Signal Bar to hedge to the back), special colour panel to the back clear
2RL 010 711-651	1	amber, 12V, with stop signal ASG-Matrix 380 mm to the front and back, special colour panels to the front and back clear
2RL 010 711-701	1	amber, 12V, with two side-mounted lights incl. LEDs, stop signal ASG-Matrix 380 mm to the front and back
2RL 010 711-891	1	amber, 12V, with two side-mounted lights incl. LEDs, two H3 work lights incl. bulbs to the back, one stop signal ASG-Matrix 580 mm to the back and LSB (LED Signal-Bar to hedge to the back), special colour panels to the front and back clear
2RL 010 711-921	1	amber, 12V, with two H3 work lights incl. bulbs each to the front and each to the back and amber indicator lights to the front and back, special colour panels to the front and back clear
		Spare parts/Accessories:
9EL 172 563-251	1	Dome, amber, without outlet
9EL 172 563-351	1	Dome, amber, with outlet
9EL 172 563-241	1	Dome, clear
9MK 181 350-101	1	LED PCB, white
2XD 176 235-001	1	Alley Light (LED side-mounted light), 12V
1GA 010 467-001	1	H3 work light, 12V
9DW 168 426-801	1	Indicator light set, amber
9DW 168 426-811	1	LED Signal Bar
		Panel for OWS 1100 mm
9EL 172 564-011	1	white
9EL 172 564-101	1	clear

*) In Germany, Austria and Switzerland not approved

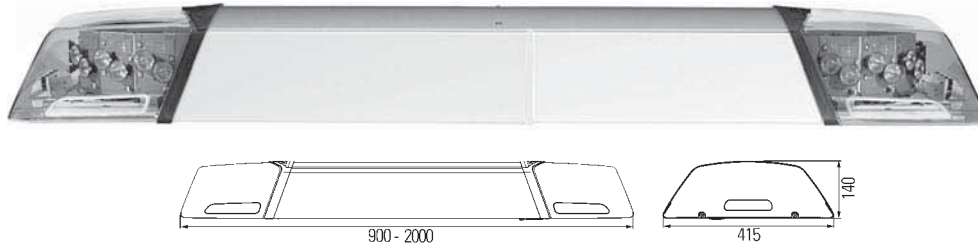

Optical warning systems OWS 7 with LED 2-level module system KL-LM2 (day/night switching system), ..., 1200 mm, 1300 mm, ...

For medium-sized to large special-purpose vehicles.

With two amber PC domes and 16 high-performance LEDs in each case, with direct emission for longer flash at daylight.

Modular design with length variance from 900 mm to 2000 mm at 100 mm intervals.

As additional lighting systems, adjustable headlamps "Alley Lights", integrated work lamps (to front or rear), amber indicators, stop signal generator or LED signal bar can optionally be selected.

Technical data:

Rated voltage: 12V/24V.

Current consumption of the module equipment: KL-LM2 (2 levels day): 2.7A.

Power consumption (2 levels day): 36W.

Operating temperature: -40 °C to +60 °C. RF suppression: CISPR 25, class 3 (conducted).

Resistant to high-pressure jet cleaners. Weight: max. 25 kg depending on features.

Part no.	Pk.	
		Optical warning system OWS 7 with LED 2-level module system KL-LM2, 1200 mm,
2RL 010 711-031	1	amber, 12V
2RL 010 711-041	1	amber, 12V, with two side-mounted lights incl. LEDs
2RL 010 711-051	1	amber, 12V, with two side-mounted lights incl. LEDs and one H3 work light incl. bulb to the back
2RL 010 711-061	1	amber, 12V, with two side-mounted lights incl. LEDs and two H3 work lights incl. bulbs to the back, special colour panel to the back clear
2RL 010 711-071	1	amber, 12V, with two side-mounted lights incl. LEDs and one H3 work light incl. bulb each to the front and each to the back, special colour panels to the front and back clear
2RL 010 711-081	1	amber, 12V, with two side-mounted lights incl. LEDs and two H3 work lights incl. bulbs each to the front and each to the back, special colour panels to the front and back clear
2RL 010 711-961	1	amber, 12V, with two H3 work lights incl. bulbs each to the front and each to the back, amber indicator lights to the front and back, special colour panels to the front and back clear
		Optical warning system OWS 7 with LED 2-level module system KL-LM2, 1300 mm,
2RL 010 711-601	1	amber, 12V
2RL 010 711-981	1	amber, 12V, with backlighting of white advertising area at the front and back *)
2RL 010 711-631	1	amber, 12V, with two H3 work lights incl. bulbs to the back and LSB (LED Signal Bar to hedge to the back), special colour panel to the back clear
2RL 010 711-751	1	amber, 12V, with one H3 work light incl. bulb to the back and stop signal ASG to the front, special colour panels to the front and back clear
2RL 010 711-791	1	amber, 12V, with two side-mounted lights incl. LEDs, two H3 work lights incl. bulbs each to the front and each to the back, special colour panels to the front and back clear
		Spare parts/Accessories:
9EL 172 563-251	1	Dome, amber, without outcut
9EL 172 563-351	1	Dome, amber, with outcut
9EL 172 563-241	1	Dome, clear
9MK 181 350-101	1	LED PCB, white
2XD 176 235-001	1	Alley Light (LED side-mounted light), 12V
1GA 010 467-001	1	H3 work light, 12V
9DW 168 426-811	1	LED Signal Bar

*) In Germany, Austria and Switzerland not approved

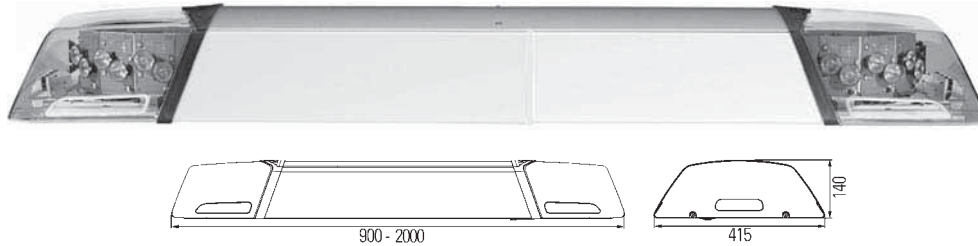

Optical warning system OWS 7 with LED 2-level module system KL-LM2 (day/night switching system), ..., 1400 mm, ...

For medium-sized to large special-purpose vehicles.

With two amber PC domes and 16 high-performance LEDs in each case, with direct emission for longer flash at daylight.

Modular design with length variance from 900 mm to 2000 mm at 100 mm intervals.

As additional lighting systems, adjustable headlamps "Alley Lights", integrated work lamps (to front or rear), amber indicators, stop signal generator or LED signal bar can optionally be selected.

Technical data:

Rated voltage: 12V/24V.

Current consumption of the module equipment: KL-LM2 (2 levels day): 2.7A.

Power consumption (2 levels day): 36W.

Operating temperature: -40 °C to +60 °C. RF suppression: CISPR 25, class 3 (conducted).

Resistant to high-pressure jet cleaners. Weight: max. 25 kg depending on features.

Part no.	Pk.	
		Optical warning system OWS 7 with LED 2-level module system KL-LM2, 1400 mm,
2RL 010 711-301	1	amber, 12V
2RL 010 711-611	1	amber, 12V, with backlighting of white advertising area at the front and back *)
2RL 010 711-091	1	amber, 12V, with one H3 work light incl. bulb to the back, special colour panel to the back clear
2RL 010 711-101	1	amber, 12V, with two H3 work lights incl. bulbs to the back
2RL 010 711-111	1	amber, 12V, with two side-mounted lights incl. LEDs
2RL 010 711-121	1	amber, 12V, with two side-mounted lights incl. LEDs and two H3 work lights incl. bulbs to the back, special colour panel to the back clear
2RL 010 711-901	1	amber, 12V, with two side-mounted lights incl. LEDs and two H3 work lights incl. bulbs to the front, special colour panels to the front and back clear
2RL 010 711-131	1	amber, 12V, with two side-mounted lights incl. LEDs and
2RL 010 711-621	1	LSB (LED Signal-Bar to hedge to the back), special colour panel to the back clear
2RL 010 711-731	1	amber, 12V, with two H3 work lights incl. bulbs to the back, one amber indicator light to the back and
2RL 010 711-581	1	LSB (LED Signal Bar to hedge to the back), special colour panel to the back clear
2RL 010 711-361	1	amber, 24V
		Spare parts:
9EL 172 563-251	1	Dome, amber, without cutout
9EL 172 563-351	1	with cutout
9EL 172 563-241	1	Dome, clear
9MK 181 350-101	1	LED PCB, white
2XD 176 235-001	1	Alley Light (LED side-mounted light), 12V
1GA 010 467-001	1	H3 work light, 12V
9DW 168 426-811	1	LED Signal Bar

*) In Germany, Austria and Switzerland not approved

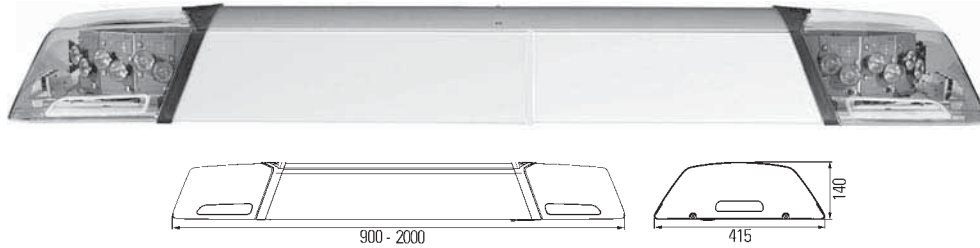

Optical warning systems OWS 7 with LED 2-level module system KL-LM2 (day/night switching system), ..., 1600 mm, ...

For medium-sized to large special-purpose vehicles.

With two amber PC domes and 16 high-performance LEDs in each case, with direct emission for longer flash at daylight.

Modular design with length variance from 900 mm to 2000 mm at 100 mm intervals.

As additional lighting systems, adjustable headlamps "Alley Lights", integrated work lamps (to front or rear), amber indicators, stop signal generator or LED signal bar can optionally be selected.

Technical data:

Rated voltage: 12V/24V.

Current consumption of the module equipment: KL-LM2 (2 levels day): 2.7A.

Power consumption (2 levels day): 36W.

Operating temperature: -40 °C to +60 °C. RF suppression: CISPR 25, class 3 (conducted).

Resistant to high-pressure jet cleaners. Weight: max. 25 kg depending on features.

Part no.	Pk.	
2RL 010 711-141	1	Optical warning system OWS 7 with LED 2-level module system KL-LM2, 1600 mm, amber, 12V
2RL 010 711-151	1	amber, 12V, with two side-mounted lights incl. LEDs and one H3 work light incl. bulb to the back, special colour panel to the back clear
2RL 010 711-161	1	amber, 12V, with two side-mounted lights incl. LEDs and two H3 work lights incl. bulbs to the back, special colour panel to the back clear
2RL 010 711-171	1	amber, 12V, with two side-mounted lights incl. LEDs and one H3 work light incl. bulb each to the front and each to the back, special colour panels to the front and back clear
2RL 010 711-181	1	amber, 12V, with two side-mounted lights incl. LEDs and two H3 work lights incl. bulbs each to the front and each to the back, special colour panels to the front and back clear
2RL 010 711-191	1	amber, 12V, with two side-mounted lights incl. LEDs, two H3 work lights incl. bulbs each to the front and each to the back and LSB (LED Signal-Bar to hedge to the back), special colour panels to the front and back clear
2RL 010 711-281	1	amber, 24V, with two side-mounted lights incl. LEDs and two H3 work lights incl. bulbs to the back, special colour panel to the back clear
2RL 010 711-781	1	amber, 24V, with two side-mounted lights incl. LEDs, two H3 work lights incl. bulbs each to the front and each to the back, amber indicator lights to the front and back and LSB (LED Signal Bar to hedge to the back), special colour panels to the front and back clear
2RL 010 711-841	1	amber, 24V, with backlighting of white advertising area at the front *)
		Spare parts:
9EL 172 563-251	1	Dome, amber, without cutout
9EL 172 563-351	1	Dome, amber, with cutout
9EL 172 563-241	1	Dome, clear
9MK 181 350-101	1	LED PCB, white
2XD 176 235-001	1	Alley Light (LED side-mounted light), 12V
1GA 010 467-001	1	H3 work light, 12V
9DW 168 426-811	1	LED Signal Bar

*) In Germany, Austria and Switzerland not approved

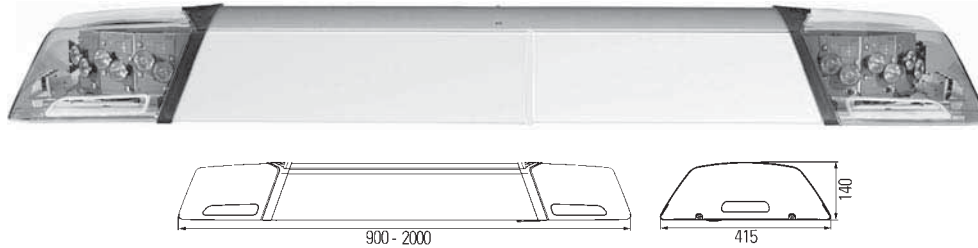

Optical warning system OWS 7 with LED 2-level module system KL-LM2 (day/night switching system), ..., 1700 mm, 1800 mm, 2000 mm

For medium-sized to large special-purpose vehicles.

With two amber PC domes and 16 high-performance LEDs in each case, with direct emission for longer flash at daylight.

Modular design with length variance from 900 mm to 2000 mm at 100 mm intervals.

As additional lighting systems, adjustable headlights "Alley Lights", integrated work lights (to front or rear), amber indicators, stop signal generator or LED signal bar can optionally be selected.

Technical data:

Rated voltage: 12V/24V.

Current consumption of the module equipment: KL-LM2 (2 levels day): 2.7A.

Power consumption (2 levels day): 36W.

Operating temperature: -40 °C to +60 °C. RF suppression: CISPR 25, class 3 (conducted).

Resistant to high-pressure jet cleaners. Weight: max. 25 kg depending on features.

Part no.	Pk.	
2RL 010 711-341	1	Optical warning system OWS 7 with LED 2-level module system KL-LM2, 1700 mm, amber, 12V, with two side-mounted lights incl. LEDs and four H3 work lights incl. bulbs to the back, special colour panels to the front and back clear
2RL 010 711-201	1	Optical warning system OWS 7 with LED 2-level module system KL-LM2, 1800 mm, amber, 24V
2RL 010 711-211	1	amber, 24V, with two side-mounted lights incl. LEDs and two H3 work lights incl. bulbs to the back, special colour panel to the back clear
2RL 010 711-541	1	amber, 24V, with two side-mounted lights incl. LEDs, two H3 work lights incl. bulbs to the back and LSB (LED Signal Bar to hedge to the back), special colour panel to the back clear
2RL 010 711-221	1	amber, 24V, with two side-mounted lights incl. LEDs and two H3 work lights incl. bulbs each to the front and each to the back, special colour panels to the front and back clear
2RL 010 711-351	1	Optical warning system OWS 7 with LED 2-level module system KL-LM2, 2000 mm, amber, 24V
		Spare parts:
9EL 172 563-251	1	Dome, amber, without cutout
9EL 172 563-351	1	Dome, amber, with cutout
9EL 172 563-241	1	Dome, clear
9MK 181 350-101	1	LED PCB, white
9DW 168 426-811	1	LED Signal Bar

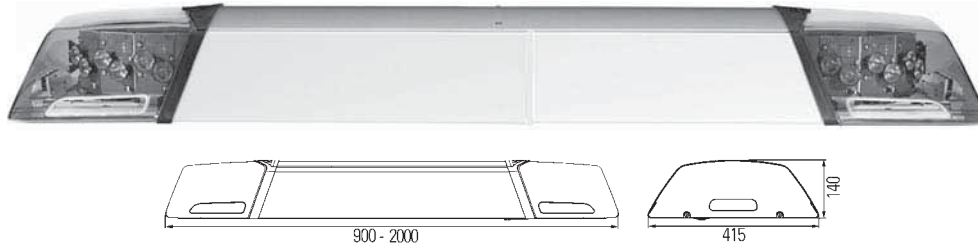

Optical warning system OWS 7 with LED 2-level module system KL-LM2 (day/night switching system), 1100 mm, 1200 mm, 1300 mm, ...

For medium-sized to large special-purpose vehicles.

With two blue PC domes and 16 high-performance LEDs in each case, with direct emission for longer flash at daylight.

Modular design with length variance from 900 mm to 2000 mm at 100 mm intervals.

As additional lighting systems, adjustable headlights "Alley Lights", integrated work lights (to front or rear), amber indicators, stop signal generator or LED signal bar can optionally be selected.

Technical data:

Rated voltage: 12V/24V.

Current consumption of the module equipment: KL-LM2 (2 levels day): 2.7A.

Power consumption (2 levels day): 36W.

Operating temperature: -40 °C to +60 °C. RF suppression: CISPR 25, class 3 (conducted).

Resistant to high-pressure jet cleaners. Weight: max. 25 kg depending on features.

Part no.	Pk.	
2RL 010 713-261	1	Optical warning system OWS 7 with LED 2-level module system KL-LM2, 1100 mm, blue, 12V, with two H3 work lights incl. bulbs to the front and back and LSB (LED Signal Bar to hedge to the back)
2RL 010 713-371	1	
2RL 010 713-501	1	Optical warning system OWS 7 with LED 2-level module system KL-LM2, 1200 mm, blue, 12V
2RL 010 713-591	1	
2RL 010 713-201	1	Optical warning system OWS 7 with LED 2-level module system KL-LM2, 1300 mm, blue, 12V, with two side-mounted lights incl. LEDs and LSB (LED Signal Bar to hedge to the back)
		Spare parts:
9EL 172 563-011	1	Dome, blue, without outcut
9EL 172 563-111	1	Dome, blue, with outcut
9EL 172 563-241	1	Dome, clear
9MK 181 350-001	1	LED PCB, blue
2XD 176 235-001	1	Alley Light (LED side-mounted light), 12V
1GA 010 467-001	1	H3 work light, 12V
9DW 168 426-801	1	Indicator light set, amber
9DW 168 426-811	1	LED Signal Bar
9EL 172 564-011	1	Panel for OWS 1100 mm, white

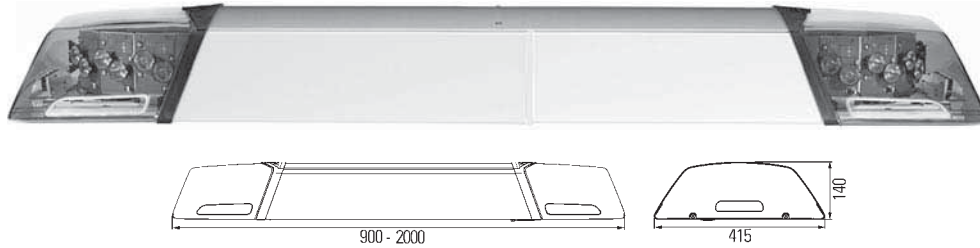

Optical warning system OWS 7 with LED 2-level module system KL-LM2 (day/night switching system), ..., 1400 mm, ...

For medium-sized to large special-purpose vehicles.

With two blue PC domes and 16 high-performance LEDs in each case, with direct emission for longer flash at daylight.

Modular design with length variance from 900 mm to 2000 mm at 100 mm intervals.

As additional lighting systems, adjustable headlights "Alley Lights", integrated work lights (to front or rear), amber indicators, stop signal generator or LED signal bar can optionally be selected.

Technical data:

Rated voltage: 12V/24V.

Current consumption of the module equipment: KL-LM2 (2 levels day): 2.7A.

Power consumption (2 levels day): 36W.

Operating temperature: -40 °C to +60 °C. RF suppression: CISPR 25, class 3 (conducted).

Resistant to high-pressure jet cleaners. Weight: max. 25 kg depending on features.

Part no.	Pk.	
		Optical warning system OWS 7 with LED 2-level module system KL-LM2, 1400 mm,
2RL 010 713-301	1	blue, 12V
2RL 010 713-141	1	blue, 12V, with LSB (LED Signal Bar to hedge to the back)
2RL 010 713-181	1	blue, 12V, with two side-mounted lights incl. LEDs and LSB (LED Signal Bar to hedge to the back)
2RL 010 713-191	1	blue, 12V, with one H3 work light incl. bulb to the back and LSB (LED Signal Bar to hedge to the back)
2RL 010 713-361	1	blue, 12V, with one H3 work light incl. bulb to the back, one stop signal ASG-Matrix 380 mm to the back and LSB (LED Signal Bar to hedge to the back)
2RL 010 713-451	1	special colour panels to the front and back clear
2RL 010 713-451	1	blue, 12V, with two side-mounted lights incl. LEDs, two H3 work lights incl. bulbs to the back and LSB (LED Signal Bar to hedge to the back), special colour panels to the front and back clear
2RL 010 713-461	1	blue, 12V, with two side-mounted lights incl. LED's, one H3 work light incl. bulb to the back, stop signal ASG-Matrix 380 mm to the back and LSB (LED Signal Bar to hedge to the back), special colour panels to the front and back clear
2RL 010 713-471	1	blue, 12V, with two side-mounted lights incl. LED's and two H3 work lights incl. bulbs to the back, special colour panels to the front and back clear
2RL 010 713-381	1	blue, 12V, with one amber indicator light to the back and LSB (LED Signal Bar to hedge to the back), special colour panels to the front and back clear
2RL 010 713-481	1	blue, 12V, with two side-mounted lights incl. LEDs, stop signal ASG-Matrix to the back and each one amber indicator light to the front and back, special colour panels to the front and back clear
2RL 010 713-491	1	blue, 12V, with stop signal ASG-Matrix 380 mm to the back, special colour panels to the front and back clear
2RL 010 713-521	1	blue, 12V, with two work lights incl. LEDs to the back and LSB (LED Signal Bar to hedge to the back), special colour panels to the front and back clear
2RL 010 713-541	1	blue, 12V, with two side-mounted lights incl. LEDs, special colour panels to the front and back clear
2RL 010 713-561	1	blue, 12V, with LSB (LED Signal Bar to hedge to the back), special colour panels to the front and back clear
2RL 010 713-571	1	blue, 12V, with one amber indicator light to the back and LSB (LED Signal Bar to hedge to the back), special colour panels to the front and back clear
2RL 010 711-711	1	blue, 12V, with two H3 work lights incl. bulbs to the back, special colour panels to the front and back clear
		Spare parts:
9EL 172 563-011	1	Dome, blue, without output
9EL 172 563-111	1	Dome, blue, with output
9EL 172 563-241	1	Dome, clear
9MK 181 350-001	1	LED PCB, blue
2XD 176 235-001	1	Alley Light (LED side-mounted light), 12V
1GA 010 467-001	1	H3 work light, 12V
9DW 168 426-801	1	Indicator light set, amber
9DW 168 426-811	1	LED Signal Bar

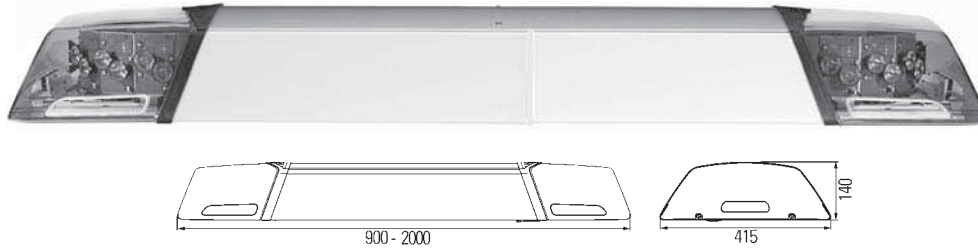

**Optical warning systems OWS 7 with LED 2-level module system KL-LM2 (day/night switching system),
..., 1500 mm, 1600 mm, 2000 mm**

For medium-sized to large special-purpose vehicles.

With two blue PC domes and 16 high-performance LEDs in each case, with direct emission for longer flash at daylight.

Modular design with length variance from 900 mm to 2000 mm at 100 mm intervals.

As additional lighting systems, adjustable headlights "Alley Lights", integrated work lights (to front or rear), amber indicators, stop signal generator or LED signal bar can optionally be selected.

Technical data:

Rated voltage: 12V/24V.

Current consumption of the module equipment: KL-LM2 (2 levels day): 2.7A.

Power consumption (2 levels day): 36W.

Operating temperature: -40 °C to +60 °C. RF suppression: CISPR 25, class 3 (conducted).

Resistant to high-pressure jet cleaners. Weight: max. 25 kg depending on features.

Part no.	Pk.	
2RL 010 713-241	1	Optical warning system OWS 7 with LED 2-level module system KL-LM2, 1500 mm, blue, 12V, with stop signal ASG-Matrix to the back and LSB (LED Signal-Bar to hedge to the back)
2RL 010 713-551	1	blue, 12V, with stop signal ASG-Matrix to the back, special colour panels to the front and back clear
2RL 010 713-271	1	blue, 12V, with two side-mounted lights incl. LEDs, two H3 work lights incl. bulbs to the back and LSB (LED Signal-Bar to hedge to the back)
2RL 010 713-581	1	blue, 12V, with two side-mounted lights incl. LEDs, two H3 work lights incl. bulbs to the back and LSB (LED Signal-Bar to hedge to the back), special colour panels to the front and back clear
2RL 010 713-131	1	Optical warning system OWS 7 with LED 2-level module system KL-LM2, 1600 mm, blue, 12V, with two side-mounted lights incl. LEDs and one H3 work light incl. bulb to the back
2RL 010 713-281	1	blue, 12V, with LSB (LED Signal-Bar to hedge to the back, with six modules)
2RL 010 713-291	1	blue, 12V, with LSB (LED Signal-Bar to hedge to the back, with eight modules)
2RL 010 713-221	1	blue, 24V
2RL 010 713-311	1	Optical warning system OWS 7 with LED 2-level module system KL-LM2, 2000 mm, blue, 24V, with one amber indicator light to the front
		Spare parts:
9EL 172 563-011	1	Dome, blue, without outcut
9EL 172 563-111	1	with outcut
9EL 172 563-241	1	Dome, clear
9MK 181 350-001	1	LED PCB, blue
2XD 176 235-001	1	Alley Light (LED side-mounted light), 12V
1GA 010 467-001	1	H3 work light, 12V
9DW 168 426-811	1	LED Signal Bar
9DW 168 426-801	1	Indicator light set, amber

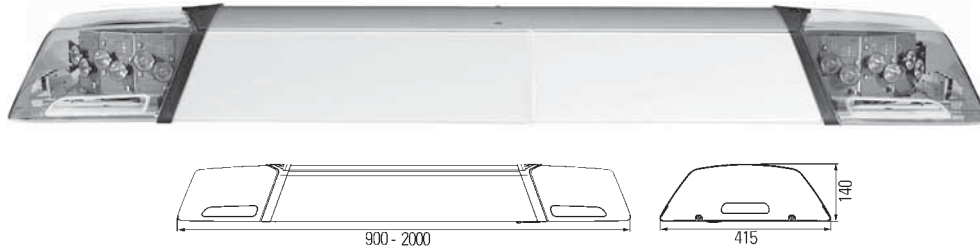

Optical warning system OWS 7 with LED 2-level rotation system KL-LM4 (day/night switching system), 1000 mm, 1100 mm, 1200 mm, 1400 mm, 1800 mm, 2000 mm

For medium-sized to large special-purpose vehicles.
 With two amber PC domes and 16 high-performance LEDs in each case, with direct emission for longer flash at daylight.

Modular design with length variance from 900 mm to 2000 mm at 100 mm intervals.
 As additional lighting systems, adjustable headlights "Alley Lights", integrated work lights (to front or rear), amber indicator lights, stop signal generator or LED signal bar can optionally be selected.

Technical data:
 Rated voltage: 12V / 24V.
 Current consumption of the module equipment: KL-LM4 (2 levels day): 2.7A.
 Power consumption (2 levels day): 36W.
 Operating temperature: -40 °C to +60 °C.
 RF suppression: CISPR 25, class 3 (conducted).
 Resistant to high-pressure jet cleaners. Weight: max. 25 kg depending on features.

Part no.	Pk.	
2RL 010 711-971	1	Optical warning system OWS 7 with LED 2-level rotation system KL-LM4, 1000 mm, amber, 12V, with two H3 work lights incl. bulbs each to the front and each to the back, amber indicator lights at the side and LSB (LED Signal-Bar to hedge to the back), special colour panels to the front and back clear
2RL 010 711-721	1	Optical warning system OWS 7 with LED 2-level rotation system KL-LM4, 1100 mm, amber, 12V, with LSB (LED Signal Bar to hedge to the back), special colour panel to the back clear
2RL 010 711-591	1	Optical warning system OWS 7 with LED 2-level rotation system KL-LM4, 1200 mm, amber, 12V, with two side-mounted lights incl. LEDs, each one H3 work light incl. bulb to the front and back and LSB (LED Signal-Bar to hedge to the back), special colour panels to the front and back clear
2RL 010 713-531	1	Optical warning system OWS 7 with LED 2-level rotation system KL-LM4, 1400 mm, amber, 12V
2RL 010 711-881	1	Optical warning system OWS 7 with LED 2-level rotation system KL-LM4, 1400 mm, amber, 24V
2RL 010 711-571	1	Optical warning system OWS 7 with LED 2-level rotation system KL-LM4, 1800 mm, amber, 24V
2RL 010 711-421	1	Optical warning system OWS 7 with LED 2-level rotation system KL-LM4, 2000 mm, amber, 24V
2RL 010 711-431	1	Optical warning system OWS 7 with LED 2-level rotation system KL-LM4, 2000 mm, amber, 24V, with LSB (LED Signal Bar to hedge to the back), special colour panel to the back clear
2RL 010 711-521	1	Optical warning system OWS 7 with LED 2-level rotation system KL-LM4, 2000 mm, amber, 24V, with two H3 work lights incl. bulbs to the back and LSB (LED Signal Bar to hedge to the back), special colour panels to the front and back clear
2RL 010 711-821	1	Optical warning system OWS 7 with LED 2-level rotation system KL-LM4, 2000 mm, amber, 24V, with two side-mounted lights incl. LEDs, two H3 work lights incl. bulbs each to the front and each to the back, amber indicator lights to the front and back and LSB (LED Signal Bar to hedge to the back), special colour panels to the front and back clear
Spare parts:		
9EL 172 563-251	1	Dome, amber, without outlet
9EL 172 563-351	1	Dome, amber, with outlet
9EL 172 563-241	1	Dome, clear
2XD 176 235-001	1	Alley Light (LED side-mounted light), 12V
1GA 010 467-001	1	H3 work light, 12V
9DW 168 426-801	1	Indicator light set, 12V
9DW 168 426-811	1	LED Signal Bar

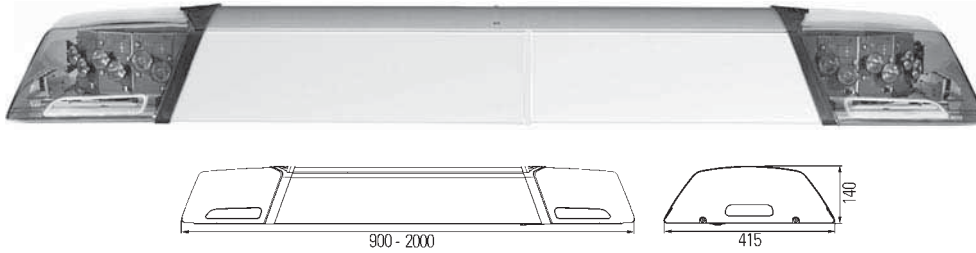

Optical warning system OWS 7 with LED 2-level rotation system KL-LM4 (day/night switching system), 1200 mm

For medium-sized to large special-purpose vehicles.

With two blue PC domes and 16 high-performance LEDs in each case, with direct emission for longer flash at daylight.

Modular design with length variance from 900 mm to 2000 mm at 100 mm intervals.

As additional lighting systems, adjustable headlights "Alley Lights", integrated work lights (to front or rear), stop signal generator or LED signal bar can optionally be selected.

Technical data:

Rated voltage: 12V / 24V.

Current consumption of the module equipment: KL-LM4 (2 levels day): 2.7A.

Power consumption (2 levels day): 36W.

Operating temperature: -40 °C to +60 °C.

RF suppression: CISPR 25, class 3 (conducted).

Resistant to high-pressure jet cleaners. Weight: max. 25 kg depending on features.

Part no.	Pk.	
2RL 010 713-391	1	Optical warning system OWS 7 with LED 2-level rotation system KL-LM4, 1200 mm, blue, 12V, special colour panels to the front and back clear
		Spare parts:
9EL 172 563-011	1	Dome, blue without outcut
9EL 172 563-241	1	Dome, clear

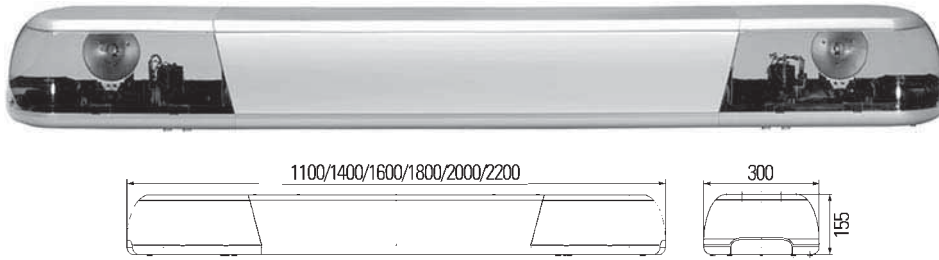

Part no.	Pk.	
2RL 009 688-...		Optical warning system OWS-QS, only accessories and spare parts available
2RL 009 279-...		Optical warning system OWS-QS, only accessories and spare parts available
		Spare parts:
9EL 863 117-071	1	Dome, amber (KL-ER, KL-MR, KL-XL2, KL-XR2)
9EL 863 117-141	1	blue (KL-LR2)
2RL 863 132-021	1	Rotating mirror module (KL-ER), 12V
9XR 855 975-001	1	Drive belts (2 pieces) (KL-ER)
2RL 863 106-001	1	Double flashing module (KL-XL2), 12V
2RL 863 106-011	1	24V
8GS 859 634-001	1	Xenon tube (KL-XL2)
2RL 863 123-001	1	Flashing module (KL-XR2), 12V
2RL 863 123-011	1	24V
8GS 863 889-001	1	Xenon tube (KL-XR2)

Bulb holder

For illumination of the middle panel.

(2 pieces for OWS-QS 1400 mm/1600 mm/1800 mm).



Part no.	Pk.	
9FT 861 790-021	1	Bulb holder with 12V bulbs
9FT 861 790-031	1	with 24V bulbs
Spare parts:		
8GP 003 594-121	10	W5W bulb, 12V
8GP 003 594-251	10	24V

Push-pull switches

With red warning light, without bulb.



Part no.	Pk.	
6ED 004 778-011	2	Push-pull switch
Accessories:		
8GP 002 095-121	10	W5/1.2 bulb, 12V1.2W
8GP 002 095-241	10	24V1.2W

Rubber bases



Part no.	Pk.	
9GD 864 286-011	1	Rubber base curved, for OWS-QS 1400 mm

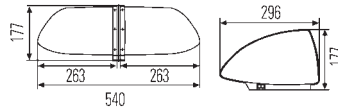
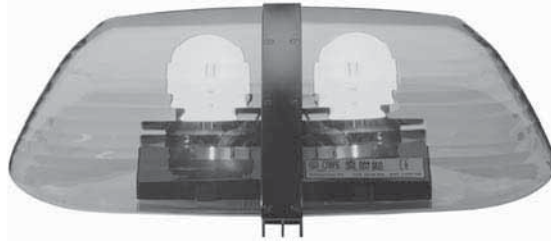

Optical warning systems OWS 540, 540 mm

For tow-service vehicles, public-authority vehicles and excessively long or excessively wide trucks.

With two domes, rubber gasket and H1 bulbs.

Light aperture (reflector dia.): 83 mm.

Amber and blue domes with optical pattern.

One 4 m long connection lead is supplied with optical warning system.

Technical data:

Rated voltage: 12V / 24V.

Operating voltage range: 10V - 15.5V at 12V, 20V - 31V at 24V.

Power consumption (rated voltage) of rotating beacons: 9.4A at 12V, 5.4A at 24V.

Operating temperature: -40 °C to +60 °C.

RF suppression: CISPR 25, class 5 (conducted).

Resistant to high pressure cleaning. Weight: max. 5 kg.

Part no.	Pk.	
		Optical warning system OWS 540, 540 mm,
		amber, 12V
2RL 007 900-501	1	amber, 12V
2RL 007 900-521	1	amber, 12V, with magnetic attachment
2RL 007 900-511	1	amber, 24V
		Spare parts:
		Dome, amber,
9EL 861 912-001	1	left
9EL 861 913-001	1	right
		Dome, blue,
9EL 861 912-021	1	left
9EL 861 913-021	1	right
		Reflector
9DX 862 849-001	1	for amber OWS, with reflector made of metal
9DX 861 976-001	1	for blue OWS
9MN 860 677-021	1	Motor, 12V/24V
		H1 bulb,
8GH 002 089-133	1	12V55W
8GH 002 089-251	1	24V70W

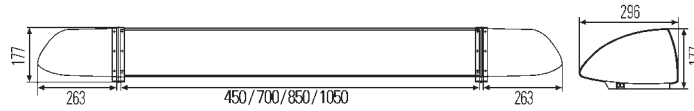

Optical warning systems

OWS 1000, 1000 mm. OWS 1250, 1250 mm. OWS 1400, 1400 mm. OWS 1600, 1600 mm

For tow-service vehicles, public-authority vehicles and excessively long or excessively wide trucks.

With two domes and panels designed to take lettering.

With H1 bulbs. Light aperture (reflector dia.): 83 mm.

Amber and blue domes with optical pattern.

One 4 m long connection lead is supplied with optical warning system.

Technical data:

Rated voltage: 12V / 24V.

Operating voltage range: 10V - 15.5V at 12V, 20V - 31V at 24V.

Power consumption (rated voltage) of rotating beacons: 9.4A at 12V, 5.4A at 24V.

Operating temperature: -40 °C to +60 °C.

RF suppression: CISPR 25, class 5 (conducted).

Resistant to high pressure cleaning. Weight: max. 5 kg.

Part no.	Pk.	
		Optical warning system, OWS 1000, 1000 mm, with white panel,
2RL 007 900-001	1	amber, 12V
2RL 007 900-261	1	amber, 24V
2RL 007 900-151	1	blue, 12V
		Optical warning system, OWS 1000, 1000 mm, with amber panel (FLN colour 1641),
2RL 007 900-191	1	amber, 12V
		Optical warning system, OWS 1400, 1400 mm, with white panel,
2RL 007 900-201	1	amber, 12V
2RL 007 900-211	1	amber, 24V
2RL 007 900-251	1	blue, 12V
		Optical warning system, OWS 1400, 1400 mm, with amber panel (FLN colour 1641),
2RL 007 900-291	1	amber, 12V
		Optical warning system, OWS 1600, 1600 mm, with white panel,
2RL 007 900-601	1	amber, 12V
2RL 007 900-611	1	amber, 24V
		Spare parts:
		Dome, amber,
9EL 861 912-001	1	left
9EL 861 913-001	1	right
		Dome, blue,
9EL 861 912-021	1	left
9EL 861 913-021	1	right
		White panel,
9EL 861 498-001	1	for OWS 1000 mm
9EL 861 498-011	1	for OWS 1400 mm
9EL 861 498-021	1	for OWS 1600 mm
		Reflector
9DX 862 849-001	1	for amber OWS, with reflector made of metal
9DX 861 976-001	1	for blue OWS
9MN 860 677-021	1	Motor, 12V/24V
		H1 bulb,
8GH 002 089-133	1	12V55W
8GH 002 089-251	1	24V70W

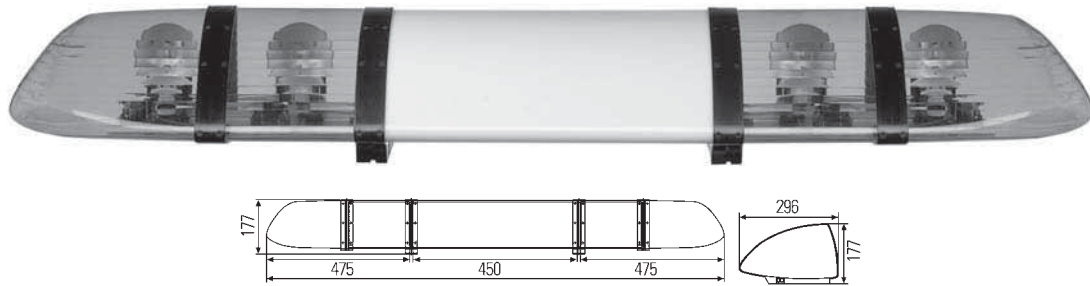

Optical warning system OWS-MR, 1400 mm

For tow-service vehicles, public-authority vehicles and excessively long or excessively wide trucks.
With two domes and white panels designed to take lettering and H1 bulbs.
Light aperture (reflector dia.): 2 x 83 mm.

PC dome with optical pattern.

One 4 m long connection lead is supplied with optical warning system.

Technical data:

Rated voltage: 12V.

Operating voltage range: 10V - 15.5V at 12V.

Power consumption: 19.5A.

Operating temperature: -40 °C to +60 °C.

RF suppression: CISPR 25, class 5 (conducted).

Resistant to high pressure cleaning.

Weight: 7 kg.

Part no.	Pk.	
2RL 007 900-701	1	Optical warning system OWS-MR, 1400 mm, amber, 12V
		Spare parts:
9EL 861 912-001	1	Dome, amber, left
9EL 861 913-001	1	right
8GH 002 089-133	1	H1 bulb, 12V55W



Optical warning systems OWS-X 1000-1600

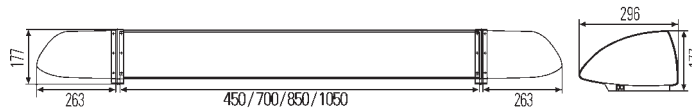

Optical warning system

OWS-X 1000, 1000 mm. OWS-X 1400, 1400 mm. OWS-X 1600, 1600 mm

For tow-service vehicles, public-authority vehicles and excessively long or excessively wide trucks. With two domes and white panels designed to take lettering.

Amber and blue domes with optical pattern.

One 4 m long connection lead is supplied with optical warning system.

Technical data:

Rated voltage: 12V/24V.

Operating voltage range: 10V - 15V at 12V, 20V - 30V at 24V.

Strobe frequency: 2.05Hz double flashes.

Power consumption of flashing beacons: 7A at 12V, 3.2A at 24V.

Operating temperature: -40 °C to +60 °C.

RF suppression: CISPR 25, class 5 (conducted).

Resistant to high pressure cleaning.

Weight: max. 9 kg.

Part no.	Pk.	
2RL 007 900-121	1	Optical warning system, OWS-X 1000, 1000 mm
2RL 007 900-171	1	amber, 12V
		blue, 12V
2RL 007 900-221	1	Optical warning system, OWS-X 1400, 1400 mm
2RL 007 900-241	1	amber, 12V
		amber, 24V
2RL 007 900-631	1	Optical warning system, OWS-X 1600, 1600 mm
2RL 007 900-681	1	amber, 24V
		blue, 24V
		Spare parts:
9EL 861 912-041	1	Dome, amber,
9EL 861 913-041	1	left
		right
9EL 861 912-051	1	Dome, blue,
9EL 861 913-051	1	left
		right
2RL 863 106-001	1	Double flashing module,
2RL 863 106-011	1	12V
8GS 859 634-001	1	24V
		Xenon tube X1
9EL 861 498-001	1	White panel,
9EL 861 498-011	1	for OWS 1000 mm
9EL 861 498-021	1	for OWS 1400 mm
		for OWS 1600 mm

Accessories for OWS- and OWS-X 540 to 1600



Panels



Part no.	Pk.	
		For OWS- and OWS-X 1000
9HB 862 827-041	1	Panel with work lights
		For OWS- and OWS-X 1400
9HB 862 827-051	1	Panel with work lights
9HB 862 827-071	1	Panel with indicator lights and work lights
		For OWS- and OWS-X 1600
9HB 862 827-061	1	Panel with work lights
9HB 862 827-081	1	Panel with indicator lights and work lights

Bulb holders

For illumination of the middle panel.

For illumination of the sign surface are
for OWS 10000 = 1 bulb holder,
for OWS 1400/1600= 2 bulb holders necessary.



Part no.	Pk.	
9FT 861 790-001	1	Bulb holder with 12V bulb
9FT 861 790-011	1	Bulb holder with 24V bulb
		Spare parts:
8GP 003 594-121	10	W5W bulb, 12V
8GP 003 594-251	10	W5W bulb, 24V

Push-pull switches

With red warning light, without bulb.



Part no.	Pk.	
6ED 004 778-011	2	Push-pull switch
		Accessories:
8GP 002 095-121	10	W5/1.2 bulb, 12V1.2W
8GP 002 095-241	10	W5/1.2 bulb, 24V1.2W

Rubber bases



Part no.	Pk.	
		Rubber base
9GD 862 080-001	1	flat, for OWS 1000
9GD 862 081-001	1	curved, for OWS 1400
9GD 862 085-001	1	curved, for OWS 1600



Accessories for OWS- and OWS-X 540 to 1600



Mounting system

Suitable for permanent mounting on trucks and cars.

Part no.	Pk.	
9XD 857 445-801	1	Fixing system set



Mounting set

For welding on to existing bracket.
Contents: 2 mounts and hardware.

Part no.	Pk.	
9XD 861 995-801	1	Mounting set



Bracket set



for direct mounting.

Part no.	Pk.	
9XD 861 990-001	1	Bracket set for OWS 1000
9XD 861 990-011	1	for OWS 1400
9XD 861 990-021	1	for OWS 1600

Optical warning systems OWS 4

old-type



	Optical warning system	Dome	1) Reflector 2) Drive belt		Bulb		
			Pk.	Pk.	Pk.	Pk.	
	2RL 005 410-02 12V	9EL 856 989-001 Dome, white can be printed as required (2 pieces)	1	1) with drive belt 9DX 859 626-001 2) 9XR 855 975-001 (2 pieces)	1	8GH 002 089-133 12V55W (H1) 8GH 002 089-251 24V70W (H1) for illumination of the white panels 8GM 002 091-131 12V10W (K)	1 1
	2RL 005 410-03 24V	9EL 856 989-001 Dome, white can be printed as required (2 pieces)	1				10
	2RL 005 410-00 12V	9EL 856 989-001 Dome, white can be printed as required (2 pieces)	1				
	2RL 005 410-08 12V	-	-				
	2RL 005 410-09 24V	-	-				
	2RL 005 410-14 24V	-	-	1) 9XR 855 975-001 (2 pieces)	1	8GH 002 089-251 24V70W (H1)	1



Rotating beacon and siren combinations RTK 7

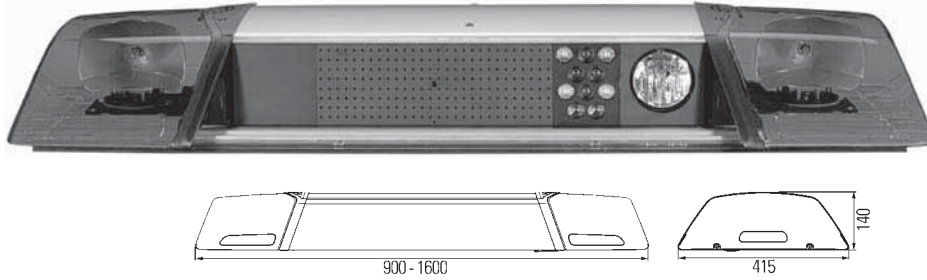

Rotating beacon and siren combinations RTK 7 with single reflector system KL-ER, 900 mm - 1600 mm

For police, fire brigade and ambulances.

With two blue PC domes and H1 bulbs. Light aperture (reflector): 125 x 80 mm.

The RTK 7 fulfils all legal regulations for acoustic and optical warning devices in accordance with EMC Directives (72/245/EEC Directive state 2005/49/EC).

Due to modular design with a length range from 900 mm to a possible 1600 mm at 100 mm intervals, the RTK 7 can be designed individually to meet the customer's requirements. The overall system has a control concept which optionally enables conventional and analog signals and also modern data bus systems (CAN open in acc. w. CIA 447).

As an alternative to the separate loudspeaker systems, loudspeakers that can be integrated at the front and rear are also available.

The RTK 7 system is rounded off by an intelligent, programmable control unit with display and built-in microphone.

Technical data:

Operating voltage range: 9V < UBAT < 16V at 12V, 20V < UBAT < 30V at 24V. Quiescent current consumption: < 0.5 mA at 12V/24V.

Undervoltage switch-off: < 9V - 0.5V at 12V, < 16V - 0.5V at 24V. Overvoltage switch-off: > 16V + 0.5V at 12V, > 32V + 0.5V at 24V.

Current-carrying capacity: control outputs < 0.3A, display outputs < 0.3A, light outputs < 0.5A to 7A at 12V/24V.

Operating temperature: -40 °C to +80 °C. RF suppression: CISPR 25, class 3 (conducted).

Operation: digital using handheld type HA 112 or HA 115. Data bus protocol: CAN open in acc. w. CIA 447 / FireCAN.

Current consumption of the module equipment: KL-ER (2 levels day): 2.7A.

Power consumption (2 levels day): 36W.

Configuration possibilities: Light dome colours: blue, clear. Loudspeaker: integrated front, integrated rear, separate.

Long-range flash module BSF-LED. LED side-mounted light Alley Light. Front-work light: Halogen, LED. Stop signal (ASG): LED.

LED Signal Bar (LSB). Amber indicator light. Information module (congestion warning). KL-A: Pre-equipped for plug-in beacon.

Part no.	Pk.	
2RM 010 70-...	1	Rotating beacon and siren combination RTK 7 with single reflector system KL-ER
		Spare parts/Accessories:
		Dome, blue,
9EL 172 563-001	1	without cutout
9EL 172 563-101	1	with cutout
		Dome, amber,
9EL 172 563-221	1	without cutout
9EL 172 563-321	1	with cutout
		Reflector
2RL 864 233-001	1	with 12V bulb
2RL 864 233-011	1	with 24V bulb
1XA 010 410-001	1	LED long-range flash light, 12V
1GA 010 467-001	1	H3 work light, 12V
2XD 176 235-001	1	Alley Light (LED side-mounted light), 12V
		LED stop signal, 12V,
2XD 176 212-011	1	with mirror-image lettering Stop Polizei, 280 mm
2XD 176 216-011	1	with normal lettering Stop Polizei and Bitte Folgen, 380 mm
2XD 176 212-021	1	with normal lettering Notarzt, 280 mm
		Central control unit light/acoustic
5DK 009 678-001	1	with two load outputs
5DK 009 678-021	1	with twelve load outputs
5DK 009 678-031	1	Central control unit light with twelve load outputs
9DW 168 426-801	1	Indicator light set, amber
9DW 168 426-811	1	LED Signal Bar
		Panel for RTK 1000 mm,
9EL 174 215-011	1	white
9EL 174 214-011	1	clear
		Panel for RTK 1100 mm,
9EL 172 564-011	1	white
9EL 172 564-101	1	clear
9GD 209 213-001	1	Gasket for base plate RTK 7 1100 mm
9MM 176 031-001	1	Loudspeaker, front
9MM 176 032-001	1	Loudspeaker, rear
8HG 860 608-011	1	Mounting bush, 170 mm, for RTK 7 with pre-equipped for plug-in beacon
8KB 174 943-011	1	Vehicle wiring harness for VW T5
9MK 174 724-011	1	Master electronics, 12V
9MK 174 724-031	1	Master electronics, 24V
8KA 178 692-801	1	Programming set
8PY 191 978-801	1	USB stick with RTK 7 software

Rotating beacon and siren combinations RTK 7

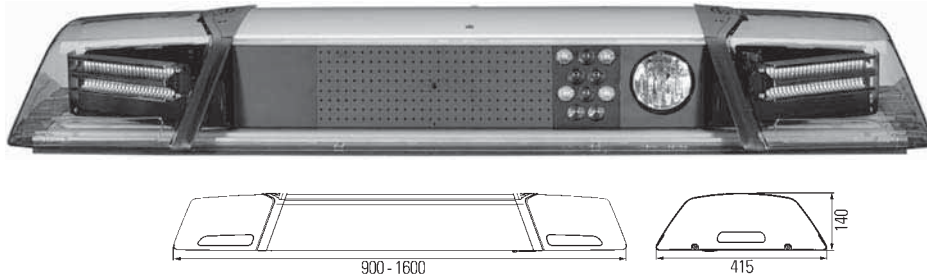

Flashing beacon and siren combinations RTK 7 with LED trough module KL-LR2, 900 - 1600 mm

For police, fire brigade, rescue vehicles, ambulances.

With two blue PC domes and 2 x 2 reflectors with 24 blue LEDs each for blue light.

The RTK 7 fulfils all legal regulations for acoustic and optical warning devices in accordance with EMC Directives (72/245/EEC Directive state 2005/49/EC).

Due to modular design with a length range from 900 mm to a possible 1600 mm at 100 mm intervals, the RTK 7 can be designed individually to meet the customer's requirements. The overall system has a control concept which optionally enables conventional and analog signals and also modern data bus systems (CAN open in acc. w. CIA 447).

As an alternative to the separate loudspeaker systems, loudspeakers that can be integrated at the front and rear are also available.

The RTK 7 system is rounded off by an intelligent, programmable control unit with display and built-in microphone.

Technical data:

Operating voltage range: 9V < UBAT < 16V at 12V, 20V < UBAT < 30V at 24V.

Quiescent current consumption: < 0.5 mA at 12V/24V.

Undervoltage switch-off: < 9V - 0.5V at 12V, < 16V - 0.5V at 24V.

Oversvoltage switch-off: > 16V + 0.5V at 12V, > 32V + 0.5V at 24V.

Current-carrying capacity: control outputs < 0.3A, display outputs < 0.3A, light outputs < 0.5A to 7A at 12V/24V.

Operating temperature: -40 °C to +80 °C. RF suppression: CISPR 25, class 3 (conducted).

Operation: digital using handheld type HA 112 or HA 115.

Data bus protocol: CAN open in acc. w. CIA 447 / FireCAN.

Current consumption of the module equipment: KL-LR2 (2 levels day): 2.7A.

Power consumption (2 levels day): 36W.

Configuration possibilities: Light dome colours: blue, clear. Loudspeaker: integrated front, integrated rear, separate.

Long-range flash module BSF-LED. LED side-mounted light Alley Light.

Front-work light: Halogen, LED. Stop signal (ASG): LED.

LED Signal Bar (LSB). Amber indicator light. Information module (congestion warning).

KL-A: Pre-equipped for plug-in beacon.

Part no.	Pk.	
2RM 010 70-...	1	Flashing Beacon and Siren Combination RTK 7 with LED trough module KL-LR2
		Spare parts/Accessories:
		Dome, blue,
		without cutout
9EL 172 563-011	1	with cutout
9EL 172 563-111	1	LED flashing beacon module, blue, 12V
2XD 171 067-251	1	LED long-range flash light, 12V
1XA 010 410-001	1	H3 work light, 12V
1GA 010 467-001	1	Alley Light (LED side-mounted light), 12V
2XD 176 235-001	1	LED stop signal, 12V,
		with mirror-image lettering Stop Polizei, 280 mm
2XD 176 212-011	1	with normal lettering Stop Polizei and Bitte Folgen, 380 mm
2XD 176 216-011	1	with normal lettering Notarzt, 280 mm
2XD 176 212-021	1	Central control unit light/acoustic
5DK 009 678-001	1	with two load outputs
5DK 009 678-021	1	with twelve load outputs
		Central control unit light
5DK 009 678-031	1	with twelve load outputs
9DW 168 426-801	1	Indicator light set, amber
9DW 168 426-811	1	LED Signal Bar
		Panel for RTK 1000 mm,
9EL 174 215-011	1	white
9EL 174 214-011	1	clear
		Panel for RTK 1100 mm,
9EL 172 564-011	1	white
9EL 172 564-101	1	clear
9GD 209 213-001	1	Gasket for base plate RTK 7 1100 mm, 2x Ø 5 mm, 4x Ø 10 mm
9MM 176 031-001	1	Loudspeaker, front
9MM 176 032-001	1	Loudspeaker, rear
8HG 860 608-011	1	Mounting bush, 170 mm, for RTK 7 with pre-equipped for plug-in beacon
8KB 174 943-011	1	Vehicle wiring harness for VW T5
9MK 174 724-011	1	Master electronics, 12V
9MK 174 724-031	1	Master electronics, 24V
8KA 178 692-801	1	Programming set
8PY 191 978-801	1	USB stick with RTK 7 software



Rotating beacon and siren combinations RTK 7

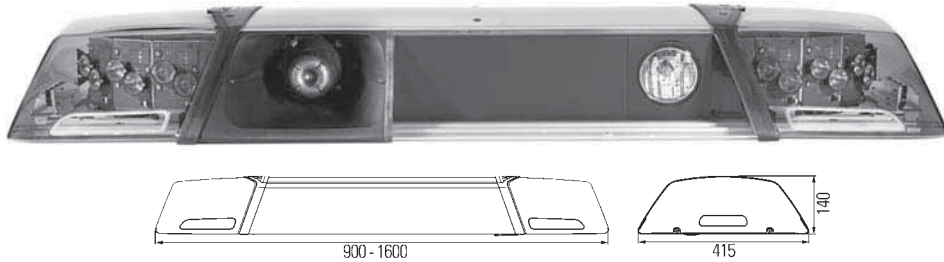

Rotating beacon and siren combinations RTK 7 with LED 2-level module system KL-LM2 (day/night switching system), 900 mm - 1600 mm

For police, fire brigade and rescue vehicles.

With two blue PC domes and 16 high-performance LEDs in each case, with direct emission for longer flash at daylight. The RTK 7 fulfils all legal regulations for acoustic and optical warning devices in accordance with EMC Directives (72/245/EEC Directive state 2005/49/EC) and ECE approval for day/night switching system.

Due to modular design with a length range from 900 mm to a possible 1600 mm at 100 mm intervals, the RTK 7 can be designed individually to meet the customer's requirements. The overall system has a control concept which optionally enables conventional and analog signals and also modern data bus systems (CAN open in acc. w. CIA 447).

As an alternative to the separate loudspeaker systems, loudspeakers that can be integrated at the front and rear are also available.

The RTK 7 system is rounded off by an intelligent, programmable control unit with display and built-in microphone.

Technical data:

Operating voltage range: $9V < U_{BAT} < 16V$ at 12V, $20V < U_{BAT} < 30V$ at 24V.

Quiescent current consumption: $< 0.5 \text{ mA}$ at 12V/24V.

Undervoltage switch-off: $< 9V - 0.5V$ at 12V, $< 16V - 0.5V$ at 24V.

Overvoltage switch-off: $> 16V + 0.5V$ at 12V, $> 32V + 0.5V$ at 24V.

Current-carrying capacity: control outputs $< 0.3A$, display outputs $< 0.3A$, light outputs $< 0.5A$ to $7A$ at 12V/24V.

Operating temperature: $-40 \text{ }^\circ\text{C}$ to $+80 \text{ }^\circ\text{C}$. RF suppression: CISPR 25, class 3 (conducted).

Operation: digital using handheld type HA 112 or HA 115.

Data bus protocol: CAN open in acc. w. CIA 447 / FireCAN .

Current consumption of the module equipment: KL-LM2 (2 levels day): 2.7A.

Power consumption (2 levels day): 36W.

Configuration possibilities:

Light dome colours: blue, clear. Loudspeaker: integrated front, integrated rear, separate.

Long-range flash module BSF-LED. Side-mounted light Alley Light.

Front-work light: Halogen, LED. Stop signal (ASG): LED.

Information module (congestion warning). KL-A: Pre-equipped for plug-in beacon.

Part no.	Pk.	
2RM 010 70-...	1	Flashing beacon and siren combinations RTK 7 with LED 2-level module system KL-LM2
		Spare parts/Accessories:
		Dome, blue,
9EL 172 563-011	1	without cutout
9EL 172 563-111	1	with cutout
9EL 172 563-241	1	Dome, clear
9MK 181 350-001	1	LED PCB, blue
1XA 010 410-001	1	LED long-range flash light, 12V
1GA 010 467-001	1	H3 work light, 12V
2XD 176 235-001	1	Alley Light (LED side-mounted light), 12V
		LED stop signal, 12V,
2XD 176 212-011	1	with mirror-image lettering Stop Polizei, 280 mm
2XD 176 216-011	1	with normal lettering Stop Polizei and Bitte Folgen, 380 mm
2XD 176 212-021	1	with normal lettering Notarzt, 280 mm
		Central control unit light/acoustic
5DK 009 678-001	1	with two load outputs
5DK 009 678-021	1	with twelve load outputs
9DW 168 426-801	1	Indicator light set, amber
9DW 168 426-811	1	LED Signal Bar
		Panel for RTK 1000 mm,
9EL 174 215-011	1	white
9EL 174 214-011	1	clear
		Panel for RTK 1100 mm,
9EL 172 564-011	1	white
9EL 172 564-101	1	clear
9BG 209 213-001	1	Gasket for base plate RTK 7 1100 mm, 2x $\varnothing 5 \text{ mm}$, 4x $\varnothing 10 \text{ mm}$
		Loudspeaker,
9MM 176 031-001	1	front
9MM 176 032-001	1	rear
8HG 860 608-011	1	Mounting bush, 170 mm, for RTK 7 with pre-equipped for plug-in beacon
8KB 174 943-011	1	Vehicle wiring harness for VW T5
		Master electronics,
9MK 174 724-011	1	12V
9MK 174 724-031	1	24V
8KA 178 692-801	1	Programming set
8PY 191 978-801	1	USB stick with RTK 7 software

Rotating beacon and siren combinations RTK 7

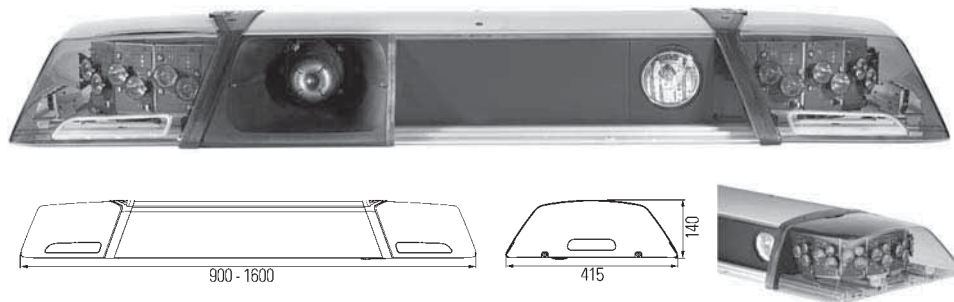

Rotating beacon and siren combinations RTK 7 with LED 2-level module system KL-LM3 (day/night switching system) and additional optics for amber warning light, 900 - 1600 mm

For police, fire brigade and rescue vehicles.

With two blue PC domes and 16 high-performance LEDs in each case, with direct emission for longer flash at daylight.

The RTK 7 fulfils all legal regulations for acoustic and optical warning devices in accordance with EMC Directives (72/245/EEC Directive state 2005/49/EC) and ECE approval for day/night switching system.

Due to modular design with a length range from 900 mm to a possible 1600 mm at 100 mm intervals, the RTK 7 can be designed individually to meet the customer's requirements.

The overall system has a control concept which optionally enables conventional and analog signals and also modern data bus systems (CAN open in acc. w. CIA 447).

As an alternative to the separate loudspeaker systems, loudspeakers that can be integrated at the front and rear are also available.

The RTK 7 system is rounded off by an intelligent, programmable control unit with display and built-in microphone.

Technical data:

Operating voltage range: 9V < UBAT < 16V at 12V, 20V < UBAT < 30V at 24V.

Quiescent current consumption: < 0.5 mA at 12V/24V.

Undervoltage switch-off: < 9V - 0.5V at 12V, < 16V - 0.5V at 24V.

Overvoltage switch-off: > 16V + 0.5V at 12V, > 32V + 0.5V at 24V.

Current-carrying capacity: control outputs < 0.3A, display outputs < 0.3A, light outputs < 0.5A to 7A at 12V/24V.

Operating temperature: -40 °C to +80 °C. RF suppression: CISPR 25, class 3 (conducted).

Operation: digital using handheld type HA 112 or HA 115.

Data bus protocol: CAN open in acc. w. CIA 447 / FireCAN .

Configuration possibilities:

Light dome colours: blue, clear. Loudspeaker: integrated front, integrated rear, separate.

Long-range flash module BSF-LED. Side-mounted light Alley Light.

Front-work light: Halogen, LED. Stop signal (ASG): LED.

Information module (congestion warning). KL-A: Pre-equipped for plug-in beacon.

Part no.	Pk.	
2RM 010 70-...	1	Flashing beacon and siren combinations RTK 7 with LED 2-level module system KL-LM3
		Spare parts/Accessories:
		Dome, blue,
9EL 172 563-011	1	without cutout
9EL 172 563-111	1	with cutout
9EL 172 563-241	1	Dome, clear
9MK 181 350-301	1	LED PCB, blue and amber
1XA 010 410-001	1	LED long-range flash light, 12V
1GA 010 467-001	1	H3 work light, 12V
2XD 176 235-001	1	Alley Light (LED side-mounted light), 12V
		LED stop signal, 12V,
2XD 176 212-011	1	with mirror-image lettering Stop Polizei, 280 mm
2XD 176 216-011	1	with normal lettering Stop Polizei and Bitte Folgen, 380 mm
2XD 176 212-021	1	with normal lettering Notarzt, 280 mm
		Central control unit light/acoustic
5DK 009 678-001	1	with two load outputs
5DK 009 678-021	1	with twelve load outputs
9DW 168 426-801	1	Indicator light set, amber
9DW 168 426-811	1	LED Signal Bar
		Panel for RTK 1000 mm,
9EL 174 215-011	1	white
9EL 174 214-011	1	clear
		Panel for RTK 1100 mm,
9EL 172 564-011	1	white
9EL 172 564-101	1	clear
9BG 209 213-001	1	Gasket for base plate RTK 7 1100 mm, 2x Ø 5 mm, 4x Ø 10 mm
9MM 176 031-001	1	Loudspeaker, front
9MM 176 032-001	1	Loudspeaker, rear
8HG 860 608-011	1	Mounting bush, 170 mm, for RTK 7 with pre-equipped for plug-in beacon
8KB 174 943-011	1	Vehicle wiring harness for VW T5
9MK 174 724-011	1	Master electronics, 12V
9MK 174 724-031	1	Master electronics, 24V
8KA 178 692-801	1	Programming set
8PY 191 978-801	1	USB stick with RTK 7 software



Rotating beacon and siren combinations RTK 7

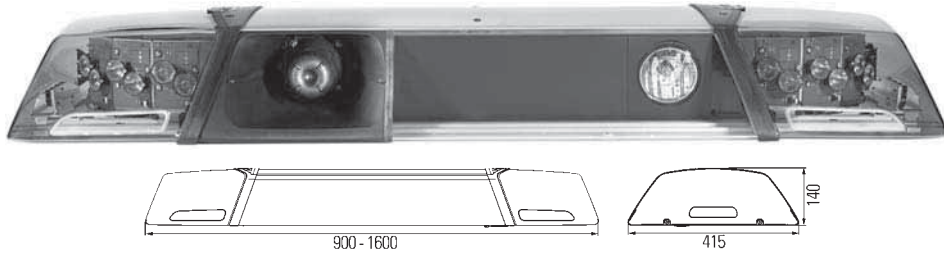

Rotating beacon and siren combinations RTK 7 with LED 2-level module system (day/night switching system) and LED rotation function KL-LM4, 900 - 1600 mm

For police, fire brigade and rescue vehicles.

With two blue PC domes and 16 high-performance LEDs in each case, with direct emission for longer flash at daylight. The RTK 7 fulfils all legal regulations for acoustic and optical warning devices in accordance with EMC Directives (72/245/EEC Directive state 2005/49/EC) and ECE approval for day/night switching system.

Due to modular design with a length range from 900 mm to a possible 1600 mm at 100 mm intervals, the RTK 7 can be designed individually to meet the customer's requirements. The overall system has a control concept which optionally enables conventional and analog signals and also modern data bus systems (CAN open in acc. w. CIA 447).

As an alternative to the separate loudspeaker systems, loudspeakers that can be integrated at the front and rear are also available.

The RTK 7 system is rounded off by an intelligent, programmable control unit with display and built-in microphone.

Technical data:

Operating voltage range: 9V < UBAT < 16V at 12V, 20V < UBAT < 30V at 24V.

Quiescent current consumption: < 0.5 mA at 12V/24V.

Undervoltage switch-off: < 9V - 0.5V at 12V, < 16V - 0.5V at 24V.

Overvoltage switch-off: > 16V + 0.5V at 12V, > 32V + 0.5V at 24V.

Current-carrying capacity: control outputs < 0.3A, display outputs < 0.3A, light outputs < 0.5A to 7A at 12V/24V.

Operating temperature: -40 °C to +80 °C. RF suppression: CISPR 25, class 3 (conducted).

Operation: digital using handheld type HA 112 or HA 115.

Data bus protocol: CAN open in acc. w. CIA 447 / FireCAN .

Current consumption of the module equipment: KL-LM (2 levels day): 1.0A at 12V, 1.5A at 24V.

Power consumption (2 levels day): 12W at 12V, 35W at 24V.

Configuration possibilities:

Light dome colours: blue, transparent. Loudspeaker: integrated front, integrated rear, separate.

Long-range flash module BSF-LED. Side-mounted light Alley Light.

Front-work light: Halogen, LED. Stop signal (ASG): LED.

Information module (congestion warning). KL-A: Pre-equipped for plug-in beacon.

Part no.	Pk.	
2RM 010 704-...	1	Rotating beacon and siren combinations RTK 7 with LED 2-level module system and LED rotation function KL-LM4
		Spare parts/Accessories:
		Dome, blue,
9EL 172 563-011	1	without cutout
9EL 172 563-111	1	with cutout
9EL 172 563-241	1	Dome, clear
1XA 010 410-001	1	LED long-range flash light, 12V
1GA 010 467-001	1	H3 work light, 12V
2XD 176 235-001	1	Alley Light (LED side-mounted light), 12V
		LED stop signal, 12V,
2XD 176 212-011	1	with mirror-image lettering Stop Polizei, 280 mm
2XD 176 216-011	1	with normal lettering Stop Polizei and Bitte Folgen, 380 mm
2XD 176 212-021	1	with normal lettering Notarzt, 280 mm
		Central control unit light/acoustic
5DK 009 678-001	1	with two load outputs
5DK 009 678-021	1	with twelve load outputs
9DW 168 426-801	1	Indicator light set, amber
9DW 168 426-811	1	LED Signal Bar
		Panel for RTK 1000 mm,
9EL 174 215-011	1	white
9EL 174 214-011	1	clear
		Panel for RTK 1100 mm,
9EL 172 564-011	1	white
9EL 172 564-101	1	clear
9GD 209 213-001	1	Gasket for base plate RTK 7 1100 mm, 2x Ø 5 mm, 4x Ø 10 mm
		Loudspeaker,
9MM 176 031-001	1	front
9MM 176 032-001	1	rear
8HG 860 608-011	1	Mounting bush, 170 mm, for RTK 7 with pre-equipped for plug-in beacon
8KB 174 943-011	1	Vehicle wiring harness for VW T5
		Master electronics,
9MK 174 724-011	1	12V
9MK 174 724-031	1	24V
8KA 178 692-801	1	Programming set
8PY 191 978-801	1	USB stick with RTK 7 software

Rotating beacon and siren combinations RTK 7

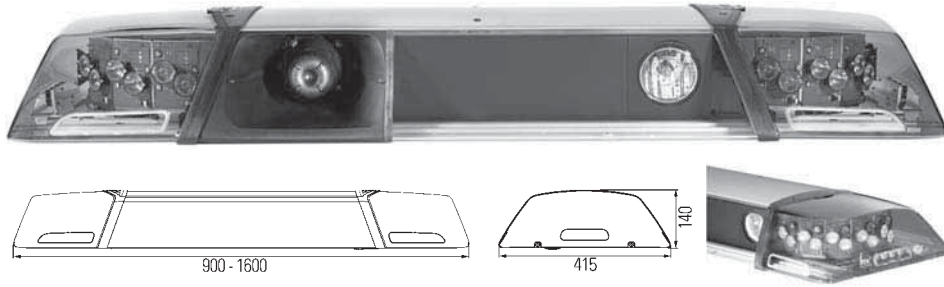

Rotating beacon and siren combinations RTK 7 with LED 2-level module system KL-LM5 (day/night switching system) and flashing infrared signal, 900 - 1600 mm

For police, fire brigade and rescue vehicles.

With two blue PC domes and 16 high-performance LEDs in each case, with direct emission for longer flash at daylight.

The RTK 7 fulfils all legal regulations for acoustic and optical warning devices in accordance with EMC Directives (72/245/EEC Directive state 2005/49/EC) and ECE approval for day/night switching system.

Due to modular design with a length range from 900 mm to a possible 1600 mm at 100 mm intervals, the RTK 7 can be designed individually to meet the customer's requirements. The overall system has a control concept which optionally enables conventional and analog signals and also modern data bus systems (CAN open in acc. w. CIA 447).

As an alternative to the separate loudspeaker systems, loudspeakers that can be integrated at the front and rear are also available.

The RTK 7 system is rounded off by an intelligent, programmable control unit with display and built-in microphone.

Technical data:

Operating voltage range: $9V < U_{BAT} < 16V$ at 12V.

Quiescent current consumption: $< 0.5 \text{ mA}$ at 12V.

Undervoltage switch-off: $< 9V - 0.5V$ at 12V.

Overvoltage switch-off: $> 16V + 0.5V$ at 12V.

Current-carrying capacity: control outputs $< 0.3A$, display outputs $< 0.3A$, light outputs $< 0.5A$ to $7A$ at 12V.

Operating temperature: $-40 \text{ }^\circ\text{C}$ to $+80 \text{ }^\circ\text{C}$. RF suppression: CISPR 25, class 3 (conducted).

Operation: digital using handheld type HA 112 or HA 115.

Data bus protocol: CAN open in acc. w. CIA 447 / FireCAN .

Power consumption: 8W at 12V.

Configuration possibilities:

Light dome colours: blue, clear. Loudspeaker: integrated front, integrated rear, separate.

Long-range flash module BSF-LED. Side-mounted light Alley Light.

Front-work light: Halogen, LED. Stop signal (ASG): LED. Amber indicator lights.

Information module (congestion warning). KL-A: Pre-equipped for plug-in beacon.

Part no.	Pk.	
2RM 010 70-...	1	Rotating beacon and siren combinations RTK 7 with LED 2-level module system KL-LM5
		Spare parts/Accessories:
		Dome, blue,
9EL 172 563-011	1	without cutout
9EL 172 563-111	1	with cutout
9EL 172 563-241	1	Dome, clear
9MK 181 350-401	1	LED PCB, blue and infrared
1XA 010 410-001	1	LED long-range flash light, 12V
1GA 010 467-001	1	H3 work light, 12V
2XD 176 235-001	1	Alley Light (LED side-mounted light), 12V
		LED stop signal, 12V,
2XD 176 212-011	1	with mirror-image lettering Stop Polizei, 280 mm
2XD 176 216-011	1	with normal lettering Stop Polizei and Bitte Folgen, 380 mm
2XD 176 212-021	1	with normal lettering Notarzt, 280 mm
		Central control unit light/acoustic
5DK 009 678-001	1	with two load outputs
5DK 009 678-021	1	with twelve load outputs
9DW 168 426-801	1	Indicator light set, amber
9DW 168 426-811	1	LED Signal Bar
		Panel for RTK 1000 mm,
9EL 174 215-011	1	white
9EL 174 214-011	1	clear
		Panel for RTK 1100 mm,
9EL 172 564-011	1	white
9EL 172 564-101	1	clear
9GD 209 213-001	1	Gasket for base plate RTK 7 1100 mm, 2x $\varnothing 5 \text{ mm}$, 4x $\varnothing 10 \text{ mm}$
		Loudspeaker,
9MM 176 031-001	1	front
9MM 176 032-001	1	rear
8HG 860 608-011	1	Mounting bush, 170 mm, for RTK 7 with pre-equipped for plug-in beacon
8KB 174 943-011	1	Vehicle wiring harness for VW T5
9MK 174 724-011	1	Master electronics,
8KA 178 692-801	1	Programming set
8PY 191 978-801	1	USB stick with RTK 7 software



Rotating beacon and siren combinations RTK 7

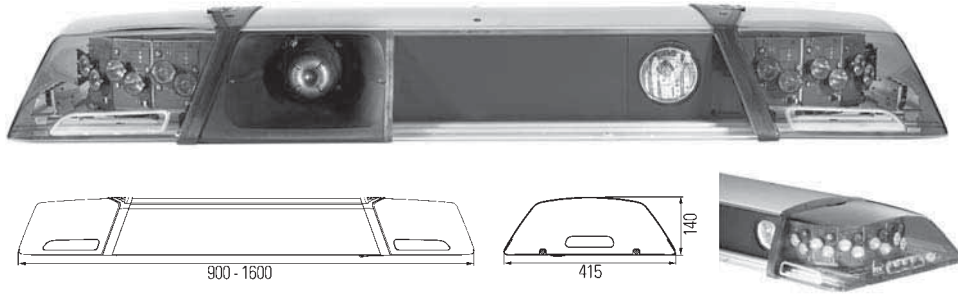

Rotating beacon and siren combinations RTK 7 with LED 2-level module system (day/night switching system), LED rotation function KL-LM6 and rotating infrared signal, 900 - 1600 mm

For police, fire brigade and rescue vehicles.

With two blue PC domes and 16 high-performance LEDs in each case, with direct emission for longer flash at daylight.

The RTK 7 fulfils all legal regulations for acoustic and optical warning devices in accordance with EMC Directives (72/245/EEC Directive state 2005/49/EC) and ECE approval for day/night switching system.

Due to modular design with a length range from 900 mm to a possible 1600 mm at 100 mm intervals, the RTK 7 can be designed individually to meet the customer's requirements. The overall system has a control concept which optionally enables conventional and analog signals and also modern data bus systems (CAN open in acc. w. CIA 447).

As an alternative to the separate loudspeaker systems, loudspeakers that can be integrated at the front and rear are also available.

The RTK 7 system is rounded off by an intelligent, programmable control unit with display and built-in microphone.

Technical data:

Operating voltage range: $9V < U_{BAT} < 16V$ at 12V.

Quiescent current consumption: $< 0.5 \text{ mA}$ at 12V.

Undervoltage switch-off: $< 9V - 0.5V$ at 12V.

Overvoltage switch-off: $> 16V + 0.5V$ at 12V.

Current-carrying capacity: control outputs $< 0.3A$, display outputs $< 0.3A$, light outputs $< 0.5A$ to $7A$ at 12V.

Operating temperature: $-40 \text{ }^\circ\text{C}$ to $+80 \text{ }^\circ\text{C}$. RF suppression: CISPR 25, class 3 (conducted).

Operation: digital using handheld type HA 112 or HA 115.

Data bus protocol: CAN open in acc. w. CIA 447 / FireCAN .

Power consumption: $8W$ at 12V.

Configuration possibilities:

Light dome colours: blue, clear. Loudspeaker: integrated front, integrated rear, separate.

Long-range flash module BSF-LED. Side-mounted light Alley Light.

Front-work light: Halogen, LED. Stop signal (ASG): LED. Amber indicator lights.

Information module (congestion warning). KL-A: Pre-equipped for plug-in beacon.

Part no.	Pk.	
2RM 010 70-...	1	Rotating beacon and siren combinations RTK 7 with LED 2-level module system and LED rotation function KL-LM6
		Spare parts/Accessories:
		Dome, blue,
9EL 172 563-011	1	without cutout
9EL 172 563-241	1	Dome, clear
9MK 181 350-401	1	LED PCB, blue and infrared
1XA 010 410-001	1	LED long-range flash light, 12V
1GA 010 467-001	1	H3 work light, 12V
2XD 176 235-001	1	Alley Light (LED side-mounted light), 12V
		LED stop signal, 12V,
2XD 176 212-011	1	with mirror-image lettering Stop Polizei, 280 mm
2XD 176 216-011	1	with normal lettering Stop Polizei and Bitte Folgen, 380 mm
2XD 176 212-021	1	with normal lettering Notarzt, 280 mm
		Central control unit light/acoustic
5DK 009 678-001	1	with two load outputs
5DK 009 678-021	1	with twelve load outputs
9DW 168 426-801	1	Indicator light set, amber
9DW 168 426-811	1	LED Signal Bar
		Panel for RTK 1000 mm,
9EL 174 215-011	1	white
9EL 174 214-011	1	clear
		Panel for RTK 1100 mm,
9EL 172 564-011	1	white
9EL 172 564-101	1	clear
9GD 209 213-001	1	Gasket for base plate RTK 7 1100 mm, 2x $\varnothing 5 \text{ mm}$, 4x $\varnothing 10 \text{ mm}$
		Loudspeaker,
9MM 176 031-001	1	front
9MM 176 032-001	1	rear
8HG 860 608-011	1	Mounting bush, 170 mm, for RTK 7 with pre-equipped for plug-in beacon
8KB 174 943-011	1	Vehicle wiring harness for VW T5
9MK 174 724-011	1	Master electronics,
8KA 178 692-801	1	Programming set
8PY 191 978-801	1	USB stick with RTK 7 software

Rotating beacon and siren combinations RTK 7

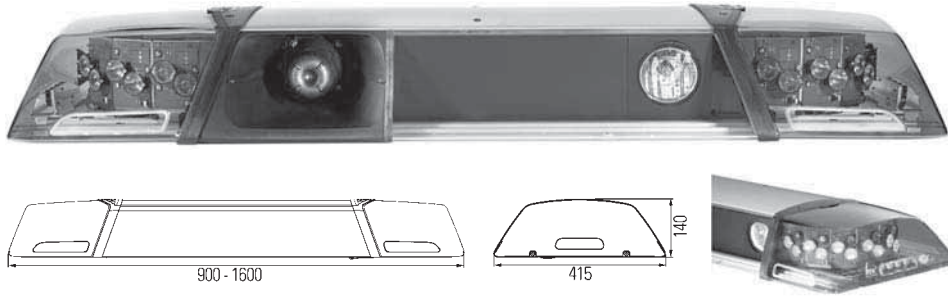

Rotating beacon and siren combinations RTK 7 with LED 2-level module system (day/night circuit, flashing by day / rotating at night), LED rotation function KL-LM7 and infrared flight visibility marker, 900 mm - 1600 mm

For police, fire brigade and rescue vehicles.

With two blue PC domes and 16 high-performance LEDs in each case, with direct emission for longer flash at daylight. The RTK 7 fulfils all legal regulations for acoustic and optical warning devices in accordance with EMC Directives (72/245/EEC Directive state 2005/49/EC) and ECE approval for day/night switching system.

Due to modular design with a length range from 900 mm to a possible 1600 mm at 100 mm intervals, the RTK 7 can be designed individually to meet the customer's requirements. The overall system has a control concept which optionally enables conventional and analog signals and also modern data bus systems (CAN open in acc. w. CIA 447).

As an alternative to the separate loudspeaker systems, loudspeakers that can be integrated at the front and rear are also available.

The RTK 7 system is rounded off by an intelligent, programmable control unit with display and built-in microphone.

Technical data:

Operating voltage range: $9V < U_{BAT} < 16V$ at 12V. Quiescent current consumption: $< 0.5 \text{ mA}$ at 12V.

Undervoltage switch-off: $< 9V - 0.5V$ at 12V. Overvoltage switch-off: $> 16V + 0.5V$ at 12V.

Current-carrying capacity: control outputs $< 0.3A$, display outputs $< 0.3A$, light outputs $< 0.5A$ to 7A at 12V.

Operating temperature: $-40 \text{ }^\circ\text{C}$ to $+80 \text{ }^\circ\text{C}$. RF suppression: CISPR 25, class 3 (conducted).

Operation: digital using handheld type HA 112 or HA 115.

Data bus protocol: CAN open in acc. w. CIA 447 / FireCAN .

Power consumption: 8W at 12V.

Configuration possibilities:

Light dome colours: blue, clear. Loudspeaker: integrated front, integrated rear, separate.

Long-range flash module BSF-LED. Side-mounted light Alley Light.

Front-work light: Halogen, LED. Stop signal (ASG): LED. Amber indicator lights.

Information module (congestion warning). KL-A: Pre-equipped for plug-in beacon.

Part no.	Pk.	
2RM 010 705-...	1	Rotating beacon and siren combinations RTK 7 with LED 2-level module system and LED rotation function KL-LM7
		Spare parts/Accessories:
		Dome, blue,
9EL 172 563-011	1	without cutout
9EL 172 563-111	1	with cutout
9EL 172 563-241	1	Dome, clear
9MK 181 350-401	1	LED PCB, blue and infrared
1XA 010 410-001	1	LED long-range flash light, 12V
1GA 010 467-001	1	H3 work light, 12V
2XD 176 235-001	1	Alley Light (LED side-mounted light), 12V
		LED stop signal, 12V,
2XD 176 212-011	1	with mirror-image lettering Stop Polizei, 280 mm
2XD 176 216-011	1	with normal lettering Stop Polizei and Bitte Folgen, 380 mm
2XD 176 212-021	1	with normal lettering Notarzt, 280 mm
		Central control unit light/acoustic
5DK 009 678-001	1	with two load outputs
5DK 009 678-021	1	with twelve load outputs
9DW 168 426-801	1	Indicator light set, amber
9DW 168 426-811	1	LED Signal Bar
		Panel for RTK 1000 mm,
9EL 174 215-011	1	white
9EL 174 214-011	1	clear
		Panel for RTK 1100 mm,
9EL 172 564-011	1	white
9EL 172 564-101	1	clear
9GD 209 213-001	1	Gasket for base plate RTK 7 1100 mm, 2x $\varnothing 5 \text{ mm}$, 4x $\varnothing 10 \text{ mm}$
		Loudspeaker,
9MM 176 031-001	1	front
9MM 176 032-001	1	rear
8HG 860 608-011	1	Mounting bush, 170 mm, for RTK 7 with pre-equipped for plug-in beacon
8KB 174 943-011	1	Vehicle wiring harness for VW T5
9MK 174 724-011	1	Master electronics
8KA 178 692-801	1	Programming set
8PY 191 978-801	1	USB stick with RTK 7 software

Stop signal LED-type ASG-Matrix

With set, programmed fonts and the possibility of arbitrary text entry using the handheld device HA 112 or HA 115. 10 pre-programmed languages each with up to 50 different text messages, e. g. airports, customs and fire service.

Technical data:

Rated voltage: 12V.

Max. luminous intensity: 1000 mcd.

Current consumption: max. 500 mA.

Video output load: max. 500 mA.

Light-dark setting: at an ambient brightness of approx. 200 Lux the device switches automatically to a dimmed display mode.

Font height: max. 80 mm.

Installation direction: front and rear.



Part no.	Pk.	
2XD 010 978-001	1	Stop signal ASG Matrix with 280 mm line width
2XD 010 978-011	1	with 380 mm line width
Spare parts:		
2XD 176 212-001	1	Circuit board for ASG-Matrix 280 mm
2XD 176 216-001	1	for ASG-Matrix 380 mm
Bracket		
8HG 174 791-401	1	for ASG-Matrix 280 mm
8HG 174 791-411	1	for ASG-Matrix 380 mm

Digital control units

With LCD display and microphone function.



Part no.	Pk.	
9SX 010 391-001	1	Digital control unit HA 115 for Germany
9SX 010 391-011	1	HA 112 for Europe
9SX 010 392-001	1	Gateway
8KB 173 872-001	1	Lead without NF-switching

NF-Switchbox

Switchover between radio, radio override or other audio sources and microphone.

Input via cinch socket.

Operation using RAD button on the control unit or individual switch.

With switchover line.



Part no.	Pk.	
9SX 010 393-801	1	NF-Switchbox

Vehicle wiring harness

Part no.	Pk.	
8KB 174 943-001	1	Vehicle wiring harness, 12V, CAN and analog
8KB 174 934-001	1	only CAN



Control units

eAZD control unit with programmable keys with function, indicator and background illumination for control of optical and acoustic signals.
With 300 mm long lead.

Part no.	Pk.	
9SX 008 902-021	1	eAZD control unit, 12V/24V
8HG 863 383-001	1	Accessories: Installation frame (DIN) shaft for installation of eAZD and eNF, delivered with eNF blind cover
8KB 864 105-801	1	Extension lead set Contents: 2 leads, each 350 mm long



eNF switching unit for control of communication functions: radio switch on (for standardised and non-standardised two-way radios), Microphone switch (up to 2 microphones), CD player connection, multiple stage volume control, function illumination, background illumination.
Contents: control unit, operating panel and 2 m connection lead.
Technical data:

Rated voltage: 12V / 24V.
Operating voltage: 9V - 32V.
Power consumption: max. 500 mA.
NF level
Microphone 1: USS up to 4 mV / 450 mV.
Microphone 2: USS up to 4 mV / 450 mV.
Radio: USS to 800 mV, Recorder: 2000 mV.
RF suppression: CISPR 25, class 5 (conducted).
Operating temperature: -40 °C to +90 °C.
Type of protection: dustproof.

Part no.	Pk.	
9SX 863 114-001	1	Can be used separately or in combination with eAZD control unit. eNF switching unit, 12V / 24V
8HG 863 383-001	1	Accessories: Installation frame (DIN) shaft for installation of eAZD and eNF, delivered with eNF blind cover

Leads

Part no.	Pk.	
8KB 863 322-001	1	eNF lead for handset, 1 m
8KB 863 322-011	1	for handset, 3 m
8KB 863 323-001	1	for FuG 7/8, 1 m
8KB 863 323-011	1	for FuG 7/8, 3 m
8KB 863 324-001	1	for microphone, 1 m

Microphone

With on/off switch, 500 mm spirally lead, holder, plug and volume control.



Part no.	Pk.	
9MM 862 358-801	1	Hand-held microphone
8HG 854 516-001	4	Spare parts/Accessories: Bracket
8KB 862 689-001	1	Adapter lead, 1000 mm
9MK 860 255-001	1	Device socket



Microphone

With holder and 500 mm long lead.

Part no.	Pk.	
9MM 859 358-801	1	Hand-held microphone
Accessories:		
8KB 862 689-001	1	Adapter lead, 1000 mm
9MK 860 255-001	1	Device socket



Rubber bases

For curved vehicle roofs.

Part no.	Pk.	
9GD 175 947-001	1	Rubber base, 900 mm
9GD 175 947-011	1	1000 mm
9GD 175 947-021	1	1100 mm
9GD 175 947-031	1	1200 mm
9GD 175 947-041	1	1300 mm
9GD 175 947-051	1	1400 mm
9GD 175 947-061	1	1500 mm
9GD 175 947-071	1	1600 mm



For straight vehicle roofs, adaptable to different widths.

Part no.	Pk.	
9GD 176 514-871	1	Rubber base (two pieces) 1600 mm, plus two side seals



Rail carrier

Part no.	Pk.	
9XD 177 162-801	1	Rail carrier set



Loudspeaker

Part no.	Pk.	
9MM 863 164-051	1	Loudspeaker, external, with AMP-Superseal plug connector

Vehicle wiring harness

Part no.	Pk.	
8KB 174 943-001	1	Vehicle wiring harness, 12V, CAN and analog
8KB 174 934-001	1	only CAN

Sound warning system RTK-VE 7

For concealed installation in cars, trucks and motorcycles.
For police, rescue and fire brigade.
The unit can easily be combined with all HELLA KL, KLX and OWS.

Contents:

1 control unit 12V ZSE-VE 7

1 mounting kit and installation instructions

Technical data - control unit ZSE-VE 7:

Rated voltage: 12V.

Operating voltage: 9V - 16V.

Operating temperature: -40 °C to +80 °C.

RF suppression: VDE 0879 part 3, CISPR 25, class 3 (conducted).

Frequency, city signal: 410Hz low, 547Hz high.

Frequency, country signal: 362Hz low, 483Hz high.

Other frequencies are programmed for specific countries.

Control of the tone sequence and rotating beacons is accomplished over separate individual switches or alarm pull/rotary switches.

Type of protection loudspeaker: resistant to high pressure cleaning.

Type of protection ZSE-VE7: dustproof and splash-waterproof with heightened pressure.



Part no.	Pk.	
3SL 009 678-801	1	Signal-warning set, 12V
8KB 175 501-001	1	Vehicle wiring harness 2 LK for connecting the RTK-VE 7 to the vehicle electrics
9MM 863 164-051	1	Accessories: Loudspeaker with AMP-Superseal plug connector (2 off required)
9MM 010 657-001	1	Licence plate loudspeaker with AMP-Superseal plug connector (1 off required)

Control units

eAZD control unit with programmable keys with function, indicator and background illumination for control of optical and acoustic signals.

With 300 mm long lead.

Part no.	Pk.	
9SX 008 902-021	1	eAZD control unit, 12V/24V
8HG 863 383-001	1	Accessories: Installation frame (DIN) shaft for installation of eAZD and eNF, delivered with eNF blind cover
8KB 864 105-801	1	Extension lead set Contents: 2 leads, each 350 mm long

Control units

eNF switching unit for control of communication functions: radio switch on (for standardised and non-standardised two-way radios).

Microphone switch (up to 2 microphones), CD player connection, multiple stage volume control, function illumination, background illumination.

Contents: control unit, operating panel and 2 m connection lead.

Technical data:

Rated voltage: 12V / 24V.

Operating voltage: 9V - 32V.

Power consumption: max. 500 mA.

NF level

Microphone 1: USS up to 4 mV / 450 mV.

Microphone 2: USS up to 4 mV / 450 mV.

Radio: USS to 800 mV, Recorder: 2000 mV.

RF suppression: CISPR 25, class 5 (conducted).

Operating temperature: -40 °C to +90 °C.

Type of protection: dustproof.



Part no.	Pk.	
9SX 863 114-001	1	Can be used separately or in combination with eAZD control unit. eNF switching unit, 12V / 24V
8HG 863 383-001	1	Accessories: Installation frame (DIN) shaft for installation of eAZD and eNF, delivered with eNF blind cover

Push-pull-rotary alarm switches



Part no.	Pk.	
6ZE 001 759-071	1	3 switch positions: 0 = off, left = flashing (rotating) beacon on, successive-tone signal ready for operation, pulled out = rotating beacon on, operating of successive-tone signal. Alarm switch with pre-fitted 12V bulb and spare 24V bulb
6ZE 001 759-051	1	With 4 switch positions: 0 = off, right = flashing (rotating) beacon on, normal horn ready for operation, left = flashing (rotating) beacon on, successive-tone signal ready for operation, pulled out = rotating beacon on, operating of successive-tone signal. Alarm switch with 12V bulb
8GP 002 095-121	10	Spare parts: W5/1.2 bulb, 12V1.2W
8GP 002 095-241	10	24V1.2W





Bulb overview for cars and trucks	4.02
Bulb sets	4.03-4.05
Bulbs for headlights	4.05-4.11
Bulb for signal lights	4.11-4.15
Fluorescent tubes for ceiling lights	4.16
Bulbs with glass sockets	4.11, 4.14-4.16
Bulbs with plastic caps for dashboard and interior lighting	4.16-4.19
Bulb holders	4.19
Connectors	4.20

Explanations

- + 30 / +50 / +90 / +120** = more light. Better detection of hazards and obstacles
- Blue Light** = Xenon-look bulbs
- Yellow Light** = Lower subjective self-glare in rain, snow and fog
- Double Power** = For commercial vehicles, more light, increased service life
- Heavy Duty** = Particularly resistant to blows and vibrations
- Long Life** = Service life increased by up to 100%

Bulb overview for cars and trucks

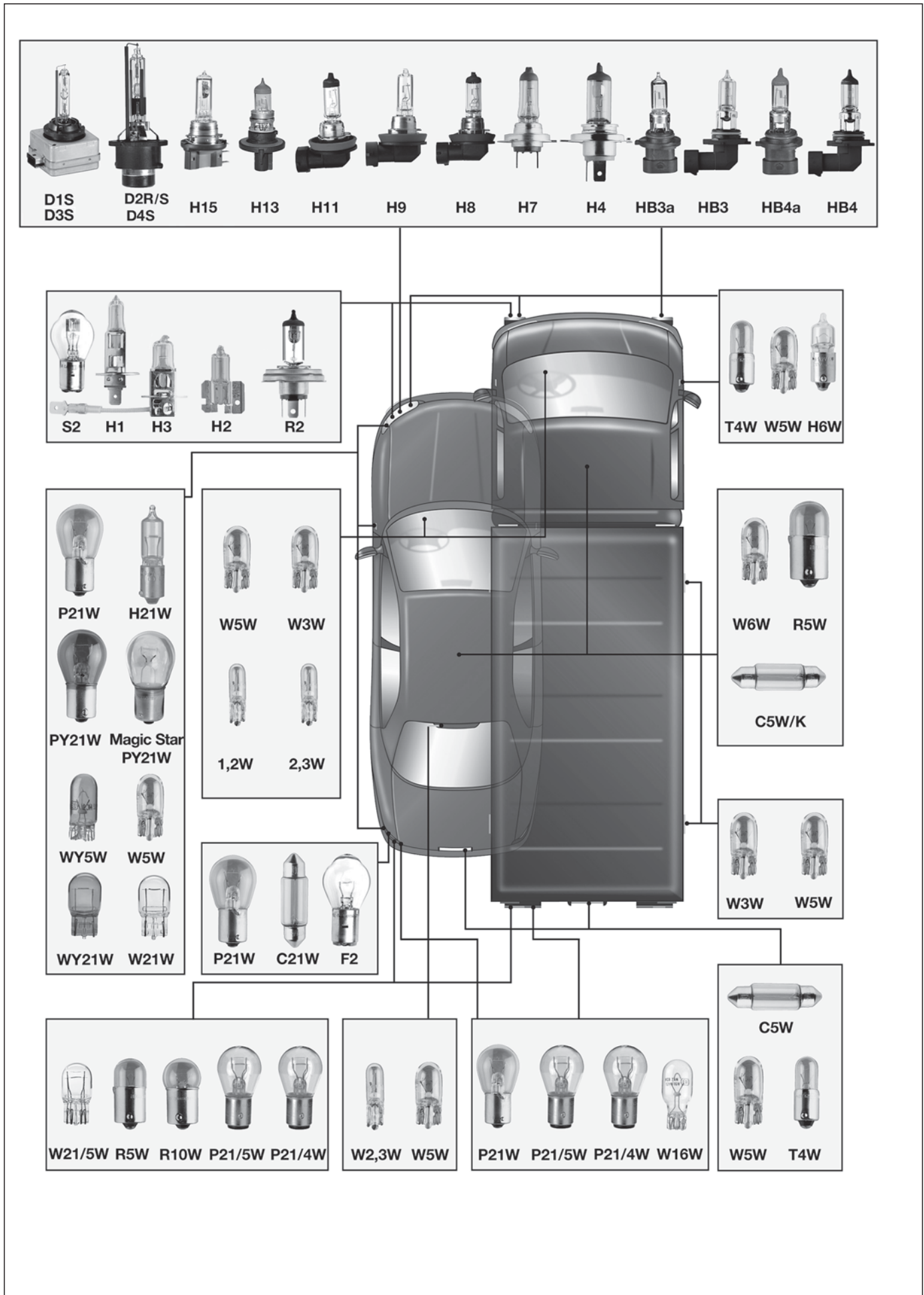

H7 bulb sets



Part no.	Pk.	Contains:
8GH 007 157-901	1	<p>Contains: 1 each of 12V55W (H7) 12V21/5W (P21/5W) 12V21/4W (P21/4W) 12V21W (P21W) 12V21W (PY21W) 12V5W (R5W) 12V5W (W5W) Blade-type fuses 10A, 15A, 30A</p> <p>H7 bulb set, 12V</p>
8GH 007 157-913	1	<p>Contains: 1 each of 12V55W (H7) 12V21/5W (P21/5W) 12V21W (P21W) 12V5W (R5W) 12V5W (W5W) 12V5W (C5W) Blade-type fuses 10A, 15A and 30A</p> <p>H7 bulb set, 12V</p>
8GH 007 157-941	1	<p>Contains: 1 each of 12V55W (H7) 12V21W (P21W) 12V5W (R5W) 12V4W (T4W) Blade-type fuses 10A, 15A and 30A</p> <p>H7 Mini bulb set, 12V</p>
8GH 007 157-931	1	<p>Contains: 2 each of 24V70W (H7) 24V21/5W (P21/5W) 24V21W (P21W) 24V10W (R10W) 24V5W (W5W) 24V5W (C5W) 2 each of blade-type fuses 10A, 15A and 30A</p> <p>H7 bulb set, 24V</p>

H4 bulb sets



Part no.	Pk.	Contains:
8GJ 002 525-913	1	Contains: 1 each of 12V60/55W (H4) 12V21/5W (P21/5W) 12V21W (P21W) 12V5W (R5W) 12V4W (T4W) Blade-type fuses 10A, 15A and 30A
8GJ 002 525-971	1	Contains: 1 each of 12V60/55W (H4) 12V21W (P21W) 12V5W (R5W) 24V4W (T4W) Blade-type fuses 10A, 15A and 30A
8GJ 002 525-941	1	Contains: 2 each of 24V75/70W (H4) 24V21/5W (P21/5W) 24V21W (P21W) 24V10W (R10W) 24V5W (C5W) 24V4W (T4W) Blade-type fuses 10A, 15A and 30A

Assortments of bulbs for garages

For cockpit-dashboards and interior lighting



Part no.	Pk.	Contents:
8GA 007 997-901	1	Assortment of bulbs for garages 1, 12V 10 each of 8GA 007 997-101, B 10d, 12V3W 8GA 007 997-111, B 10d, 12V5W 8GA 007 997-121, BX 8.4d, 12V1.2W 8GA 007 997-041, B 8.3d, 12V1.2W 8GA 007 997-001, B 8.3d, 12V2W 8GA 007 997-141, BX 8.4d, 12V1.5W 8GA 007 997-031, B 8.5d, 12V1.2W 8GA 007 997-081, B 8.5d, 12V2W 8GA 007 997-051, BX 8.7d, 12V1.2W 8GA 007 997-091, BX 8.7d, 12V2W
		Assortment of bulbs for garages 3, 24V 10 each of 8GP 002 095-241, W 2x4.6d, 24V1.2W (W5/1.2) 8GA 007 997-181, W 2x4.6d, 24V2W 8GP 003 594-241, W 2.1x9.5d, 24V3W (W3W) 8GA 008 901-241, W 2.1x9.5d, 24V2W 8GP 003 594-251, W 2.1x9.5d, 24V5W (W5W) 8GA 007 997-061, B 8.3d, 24V1.2W 8GA 007 997-071, B 8.5d, 24V1.2W 8GA 007 997-261, BX 8.5d, 24V1.2W 8GA 007 997-191, EBS R4, 24V1.2W 8GA 007 997-201, EBS R6, 24V1.2W
8GA 007 997-921	1	Assortment of bulbs for garages 3, 24V

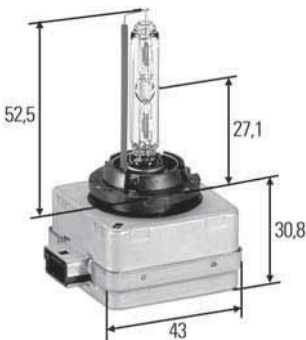

Gas discharge bulbs for headlights

Gas discharge bulb for headlights, driving lights and work lights

Part no.	Pk.	Contents:
8GS 009 028-111	1	D1S, bulb cap PK 32 d-2, 12V/24V35W HID
8GS 009 028-621	1	12V/24V35W HID, 5000° K

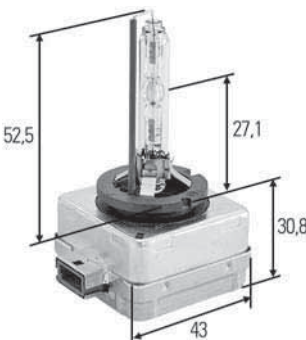

Gas discharge bulb for headlights and driving lights

Part no.	Pk.	Contents:
8GS 009 028-311	1	D3S, bulb cap Pk 32 d-5, 12V/24V35W HID

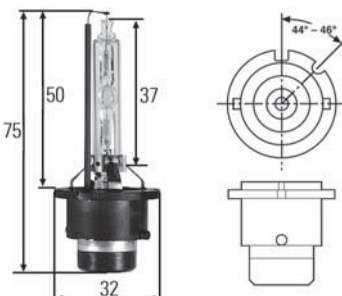

Gas discharge bulb for headlights, driving lights and work lights

Part no.	Pk.	Contents:
8GS 007 949-261	1	D2S, bulb cap P 32 d-2, 12V/24V35W HID
8GS 007 949-251	1	12V/24V35W HID, 5000° K

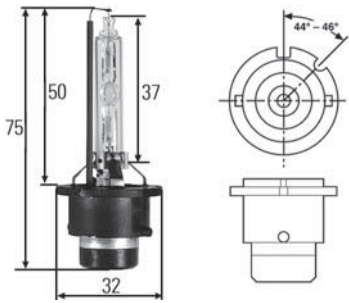

Gas discharge bulbs for headlights

Gas discharge bulb for headlights, driving lights and work lights

Part no.	Pk.	
8GS 007 949-311	1	D4S, bulb cap P 32 d-5, 12V/24V35W HID

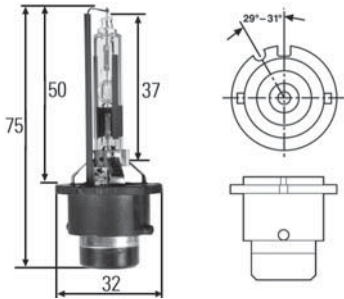

Gas discharge bulb for headlights

Part no.	Pk.	
8GS 007 001-151	1	D2R, bulb cap P 32 d-3, 12V/24V35W HID
8GS 007 001-241	1	12V/24V35W HID, 5000° K

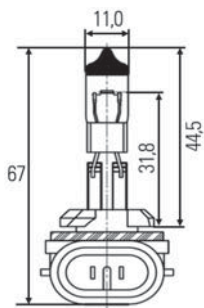

Bulbs for headlights

For fog lights

Part no.	Pk.	
8GH 008 991-021	1	H27W/1, ECE-R 37, bulb cap PG 13, 12V27W
8GH 008 991-031	1	H27W/2, ECE-R 37, bulb cap PGJ 13, 12V27W

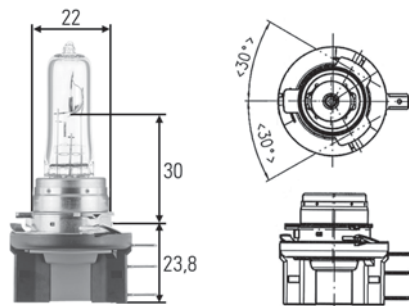

For headlights with driving-, daytime running- and position lights

Part no.	Pk.	
8GJ 168 119-001	1	H15, ECE-R 37, bulb cap PGJ 236t-1, 12V15/55W
8GJ 168 119-241	1	24V20/60W

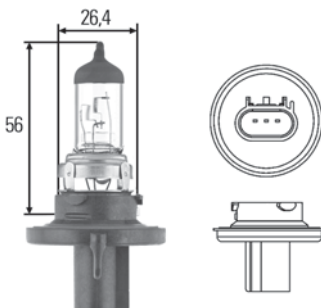

For H13 headlights (2-headlight system)

Part no.	Pk.	
8GJ 008 837-121	1	H13, ECE-R 37, bulb cap P 26.4T, 12V60/55W

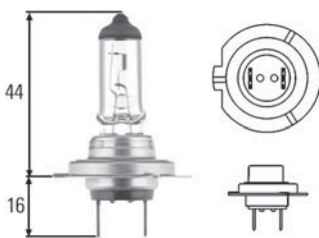
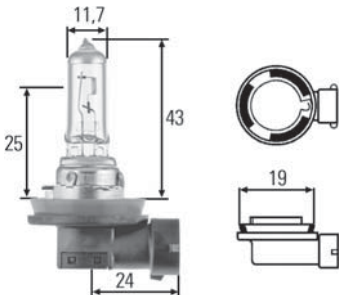
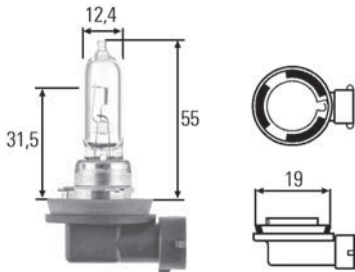
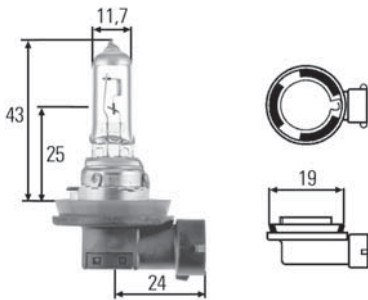

Bulbs for headlights

For H11 headlights

Part no.	Pk.	
8GH 008 358-121	1	H11, ECE-R 37, bulb cap PGJ 19-2, 12V55W
8GH 008 358-151	1	12V55W + 30, in pairs only
8GH 008 358-181	1	12V55W Blue Light, in pairs only
8GH 008 358-241	1	24V70W
8GH 008 358-251	1	24V70W Double Power

For H9 headlights and driving lights

Part no.	Pk.	
8GH 008 357-001	1	H9, ECE-R 37, bulb cap PGJ 19-5, 12V65W

For H8 headlights

Part no.	Pk.	
8GH 008 356-121	1	H8, ECE-R 37, bulb cap PGJ 19-1, 12V35W
8GH 008 356-181	1	12V35W + 30, in pairs only

For H7 headlights and fog lights

Part no.	Pk.	
8GH 007 157-121	1	H7, ECE-R 37, bulb cap PX 26 d, 12V55W
8GH 007 157-126	1	12V55W, 1 piece, carded
8GH 007 157-181	10	12V55W Blue Light, in pairs only
8GH 007 157-186	1	12V55W Blue Light, in pairs only, 2 pieces, carded
8GH 007 157-201	1	12V55W Long Life
8GH 007 157-451	1	12V55W Super Long Life
8GH 007 157-453	1	12V55W Super Long Life, 2 pieces, carded
8GH 007 157-471	1	12V55W + 50, in pairs only
8GH 007 157-473	1	12V55W + 50, in pairs only, 2 pieces, carded
8GH 007 157-531	1	12V55W + 90, in pairs only
8GH 007 157-533	1	12V55W + 90, in pairs only, 8 sets
8GH 178 560-491	1	12V55W + 120, in pairs only
8GH 178 560-493	1	12V55W + 120, in pairs only, 9 sets
8GH 007 157-481	1	12V55W Amber Light
8GH 007 157-241	1	24V70W
8GH 007 157-248	1	24V70W, 1 piece, carded
8GH 007 157-231	1	24V70W Long Life

Bulbs for headlights

For H4 headlights

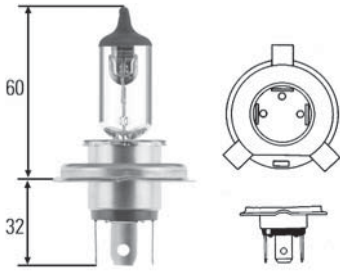

Part no.	Pk.	
8GJ 002 525-131	1	H4, ECE-R 37, bulb cap P 43 t-38, 12V60/55W
8GJ 002 525-136	1	12V60/55W, 1 piece, carded
8GJ 002 525-001	1	12V60/55W + 30, Long Life, in pairs only
8GJ 002 525-471	1	12V60/55W + 50, in pairs only
8GJ 002 525-473	1	12V60/55W + 50, in pairs only, 2 pieces, carded
8GJ 002 525-531	1	12V60/55W + 90, in pairs only
8GJ 002 525-534	1	12V60/55W + 90, in pairs only, 6 sets
8GJ 178 560-481	1	12V60/55W + 120, in pairs only
8GJ 178 560-483	1	12V60/55W + 120, in pairs only, 9 sets
8GJ 002 525-361	10	12V60/55W Blue Light, in pairs only
8GJ 002 525-366	1	12V60/55W Blue Light, in pairs only, 2 pieces, carded
8GJ 002 525-301	1	12V60/55W Heavy Duty
8GJ 002 525-481	1	12V60/55W Long Life
8GJ 002 525-891	1	12V60/55W Super Long Life
8GJ 002 525-893	1	12V60/55W Super Long Life, 2 pieces, carded
8GJ 002 525-251	1	24V75/70W
8GJ 002 525-258	1	24V75/70W, 1 piece, carded
8GJ 002 525-281	1	24V75/70W Heavy Duty
8GJ 002 525-511	1	24V75/70W Double Power
8GJ 004 173-121	1	H4, ECE-R 37, bulb cap P 45t, 12V60/55W
8GJ 003 133-242	1	24V75/70W

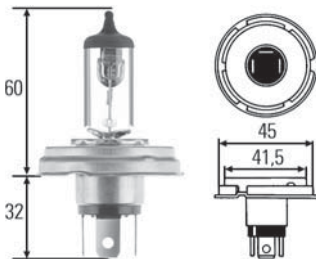

For HB4a dipped-beam headlights

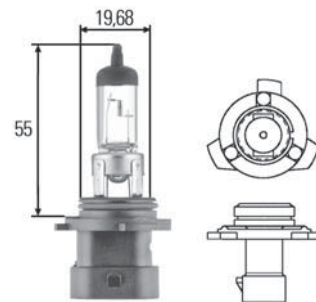

Part no.	Pk.	
8GH 005 636-201	1	HB4a, ECE-R 37, bulb cap P 22 d, 12V51W

For HB4 dipped-beam headlights

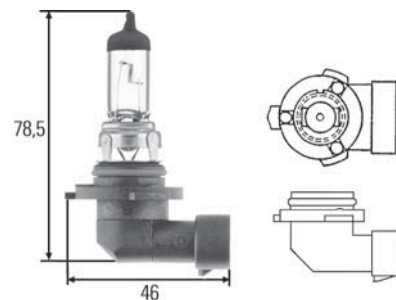

Part no.	Pk.	
8GH 005 636-121	1	HB4, ECE-R 37, bulb cap P 22 d, 12V51W

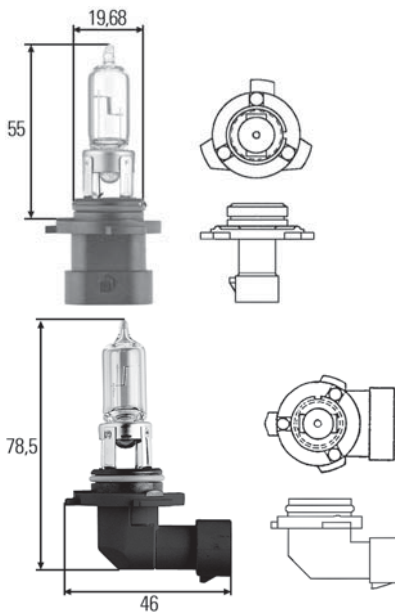

Bulbs for headlights

For HB3a main-beam headlights

Part no.	Pk.	
8GH 005 635-161	1	HB3a, ECE-R 37, bulb cap P 20 d, 12V60W

For HB3 main-beam headlights

Part no.	Pk.	
8GH 005 635-121	1	HB3, ECE-R 37, bulb cap P 20 d, 12V60W



For H3 dipped-beam headlights, driving, fog and work lights

Part no.	Pk.	
8GH 002 090-133	1	H3, ECE-R 37, bulb cap PK 22 s, 12V55W
8GH 002 090-136	1	12V55W, 1 piece, carded
8GH 002 090-271	1	12V35W
8GH 002 090-371	1	12V55W Blue Light, in pairs only
8GH 002 090-481	1	12V55W Amber Light
8GH 002 090-251	1	24V70W
8GH 002 090-253	100	
8GH 002 090-258	1	24V70W, 1 piece, carded
8GH 002 090-471	1	24V70W Double Power

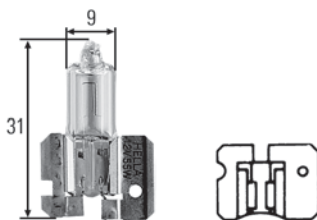

For H2 driving and fog lights

Part no.	Pk.	
8GH 002 857-241	1	H2, DIN 72 601, bulb cap X 511, 24V70W

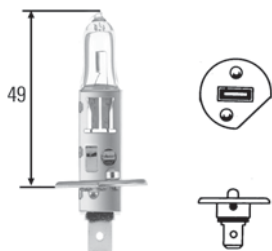

For H1 headlights, fog lights and rotating beacons

Part no.	Pk.	
8GH 002 089-133	1	H1, ECE-R 37, bulb cap P 14.5 s, 12V55W
8GH 002 089-136	1	12V55W, 1 piece, carded
8GH 002 089-141	10	12V55W Blue Light, in pairs only
8GH 002 089-146	1	12V55W Blue Light, in pairs only, 2 pieces, carded
8GH 002 089-501	1	12V55W Amber Light
8GH 002 089-351	1	12V55W Long Life
8GH 002 089-471	1	12V55W + 50, in pairs only
8GH 002 089-531	1	12V55W + 90, in pairs only
8GH 178 560-471	1	12V55W + 120, in pairs only
8GH 002 089-251	1	24V70W
8GH 002 089-253	100	24V70W
8GH 002 089-258	1	24V70W, 1 piece, carded
8GH 002 089-361	1	24V70W Heavy Duty
8GH 002 089-491	1	24V70W Double Power

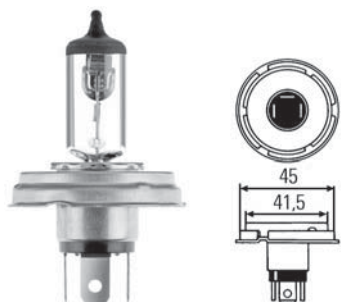

Bulbs for headlights

For asymmetrical R2 headlights

Part no.	Pk.	
8GD 002 088-141	1	R2 (Halogen), ECE-R 37, bulb cap P 45 t-41, 12V45/40W
8GD 002 088-143	1	12V45/40W, 1 piece, carded
8GD 002 088-271	1	24V55/50W



For symmetrical S1 headlights for two wheeled vehicles

Part no.	Pk.	
8GD 008 897-061	1	S1, ECE-R 37, bulb cap BA 20 d, 6V25/25W
8GD 008 897-121	1	12V25/25W



For symmetrical S2 headlights

Part no.	Pk.	
8GD 008 898-061	1	S2, ECE-R 37, bulb cap BA 20 d, 6V35/35W
8GD 002 084-131	1	12V35/35W
8GD 002 084-151	1	12V45/40W
8GD 002 084-251	1	24V45/40W

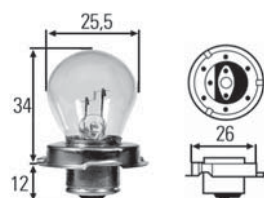

For S3 driving lights for two wheeled vehicles

Part no.	Pk.	
8GA 008 899-061	10	S3, ECE-R 37, bulb cap P 26 s, 6V15W
8GA 008 899-121	10	12V15W

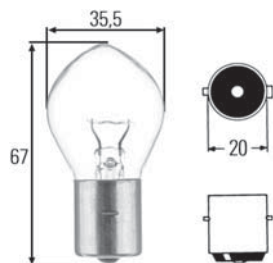

For F2 work lights, fog lights, rear fog lights and reversing lights

Part no.	Pk.	
8GA 002 083-131	1	F2, DIN 72 601, bulb cap BA 20 s, 12V35W
8GA 002 083-251	1	24V35W

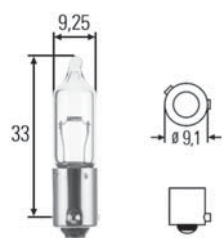

For indicator lights

Part no.	Pk.	
8GH 008 417-001	1	H21W, ECE-R 37, bulb cap BAY 9 s, 12V21W Long Life
8GH 008 417-012	10	24V21W

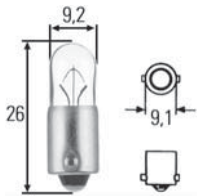

Bulbs for headlights

For position lights

Part no.	Pk.	
8GP 002 067-061	10	T4W, ECE-R 37, bulb cap BA 9 s, 6V4W
8GP 002 067-121	10	12V4W
8GP 002 067-123	1	12V4W, 2 pieces, carded
8GP 002 067-013	1	12V4W, Blue Light, in pairs only, 2 pieces, carded
8GP 002 067-241	10	24V4W
8GP 002 067-261	10	24V4W Heavy Duty



Bulbs for signal lights

For rotating beacons

Part no.	Pk.	
8GA 002 074-121	1	U, DIN 72 601, bulb cap BA 15 s, 12V45W
8GA 002 074-241	1	24V45W



For rear-stop or rear-indicator lights

Part no.	Pk.	
8GD 002 078-121	10	P21/5W, ECE-R 37, bulb cap BAY 15 d, 12V21/5W
8GD 002 078-221	10	12V21/5W Long Life
8GD 002 078-241	10	24V21/5W
8GD 002 078-248	1	24V21/5W, 2 pieces, carded
8GD 002 078-011	10	24V21/5W Heavy Duty



For rear-stop lights or rear-fog lights

Part no.	Pk.	
8GD 004 772-121	10	P21/4W, ECE-R 37, bulb cap BAZ 15 d, 12V21/4W
8GD 004 772-123	1	12V21/4W, 2 pieces, carded

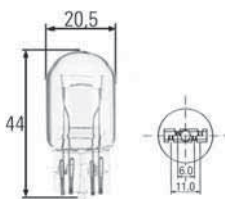

For rear and stop lights

Part no.	Pk.	
8GD 008 893-002	10	W21/5W, bulb cap W 3 x 16 g, 12V21/5W



For indicator, stop, rear fog and reverse lights

Part no.	Pk.	
8GA 002 073-121	10	P21W, ECE-R 37, bulb cap BA 15 s, 12V21W
8GA 002 073-123	1	12V21W, 2 pieces, carded
8GA 002 073-271	10	12V21W Long Life
8GA 002 073-241	10	24V21W
8GA 002 073-248	1	24V21W, 2 pieces, carded
8GA 002 073-251	10	24V21W Heavy Duty



Bulbs for signal lights

For indicator lights, stop lights, rear fog lights and reversing lights

Part no.	Pk.	
8GA 006 841-121	10	PY21W, ECE-R 37, bulb cap BAU 15 s, 12V21W amber
8GA 006 841-123	1	12V21W amber, 2 pieces, carded
8GA 006 841-801	1	12V21W Magic Star, 2 pieces
8GA 006 841-241	10	24V21W amber
8GA 006 841-251	10	24V21W amber Heavy Duty

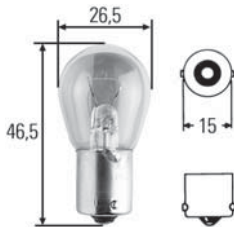

For indicator and stop lights (older versions)

Part no.	Pk.	
8GA 002 072-121	10	R, DIN 72 601, bulb cap BA 15 s, 12V18W
8GA 002 072-241	10	24V18W

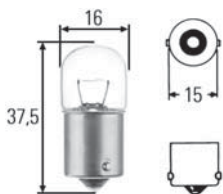

For rear, licence plate, side, clearance and interior lights

Part no.	Pk.	
8GA 002 071-121	10	R5W, ECE-R 37, bulb cap BA 15 s, 12V5W
8GA 002 071-123	1	12V5W, 2 pieces, carded
8GA 002 071-241	10	24V5W
8GA 002 071-248	1	24V5W, 2 pieces, carded
8GA 002 071-261	10	24V5W Heavy Duty
8GA 002 071-361	10	R5W, ECE-R 37, bulb cap BA 15 d, 24V5W



For rear, licence plate, side, clearance and interior lights

Part no.	Pk.	
8GA 002 071-131	10	R10W, ECE-R 37, bulb cap BA 15 s, 12V10W
8GA 002 071-133	1	12V10W, 2 pieces, carded
8GA 002 071-251	10	24V10W
8GA 002 071-258	1	24V10W, 2 pieces, carded
8GA 002 071-271	10	24V10W Heavy Duty

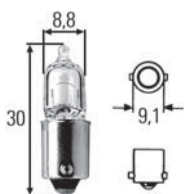

For reverse-, position-, interior- and reading lights

Part no.	Pk.	
8GH 002 473-132	1	H10W, bulb cap BA 9s, 12V20W
8GH 002 473-151	10	12V5W
8GH 002 473-191	10	12V10W

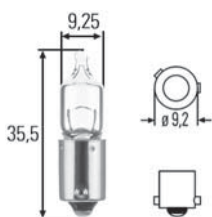

For halogen position lights and daytime running lights

Part no.	Pk.	
8GH 007 643-121	10	H6W, ECE-R 37, bulb cap BAX 9 s, 12V6W



Bulbs for signal lights

For indicator lights, stop lights, rear fog lights and reversing lights

Part no.	Pk.	
8GH 008 417-001	1	H21W, bulb cap BAY 9 s,
8GH 008 417-012	10	12V21W Long Life 24V21W

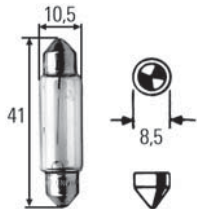

For stop and indicator lights

Part no.	Pk.	
8GM 002 091-121	10	K, DIN 72 601, bulb cap SV 8.5,
8GM 002 091-241	10	12V18W 24V18W

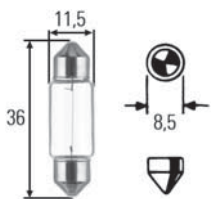

For rear, licence plate, side, clearance and interior lights

Part no.	Pk.	
8GM 002 092-121	10	C5W, ECE-R 37, bulb cap SV 8.5,
8GM 002 092-123	1	12V5W
8GM 002 092-241	10	12V5W, 2 pieces, carded 24V5W

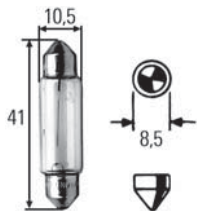

For lights

Part no.	Pk.	
8GM 002 091-131	10	K, DIN 72 601, bulb cap SV 8.5,
8GM 002 091-251	10	12V10W 24V10W

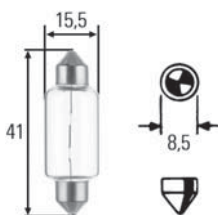

For reverse lights (older versions)

Part no.	Pk.	
8GM 002 091-141	10	Bulb cap SV 8.5,
8GM 002 091-261	10	12V15W
8GM 002 091-121	10	24V15W 12V18W
8GM 002 091-181	10	C21W, ECE-R 37, bulb cap SV 8.5, 12V21W

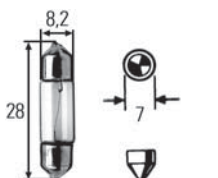

For lights

Part no.	Pk.	
8GM 002 094-121	10	M, bulb cap SV 7-8,
8GM 002 094-241	10	12V3W 24V3W

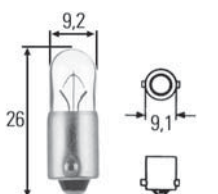

For interior and reading lights

Part no.	Pk.	
8GP 002 067-061	10	T4W, ECE-R 37, bulb cap BA 9 s,
8GP 002 067-121	10	6V4W
8GP 002 067-123	1	12V4W
8GP 002 067-013	1	12V4W, 2 pieces, carded
8GP 002 067-013	1	12V4W, Blue Light, in pairs only,
8GP 002 067-013	1	2 pieces, carded
8GP 002 067-241	10	24V4W
8GP 002 067-261	10	24V4W Heavy Duty

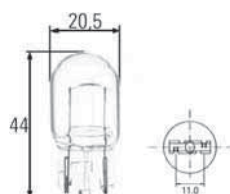
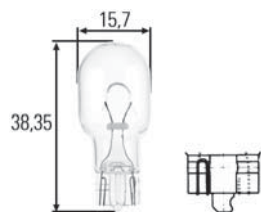
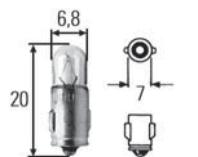
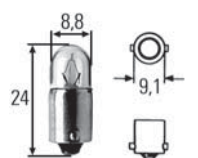
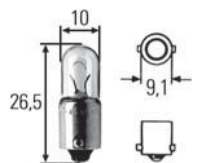
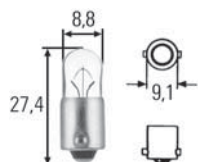

Bulbs for signal lights

For interior and reading lights

Part no.	Pk.	
8GP 007 676-121	10	Xenon, T6W, ECE-R37, bulb cap BA 9 s, 12V6W

For reading lights and hand lights

Part no.	Pk.	
8GP 008 285-001	1	Xenon, bulb cap BA 9 s, 24V7.5W

For interior lights and dashboard lighting

Part no.	Pk.	
8GP 002 068-121	10	H, (T2W/T3W) DIN 49 715, bulb cap BA 9 s, 12V2W
8GP 002 068-131	10	12V3W
8GP 002 068-241	10	24V3W

For hazard warning flasher lights

Part no.	Pk.	
8GP 002 096-061	10	B2.4W, DIN 49 848, bulb cap EP 10, 6V2.4W

For warning lights and switches

Part no.	Pk.	
8GP 002 066-121	10	J, DIN 72 601, bulb cap BA 7 s, 12V2W
8GP 002 066-241	10	24V3W

For position lights, rear fog lights and reversing lights

Part no.	Pk.	
8GA 008 246-001	10	W16W, ECE-R 37, bulb cap W 2.1 x 9.5 d, 12V16W

For stop lights

Part no.	Pk.	
8GA 008 892-002	10	W21W, ECE-R 37, bulb cap W 3 x 16 d, 12V21W

Bulbs for signal lights

For position lights and numberplate lights

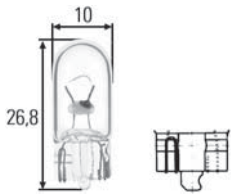

Part no.	Pk.	
8GP 003 594-141	10	W3W, ECE-R37, bulb cap W 2.1 x 9.5 d, 12V3W
8GP 003 594-241	10	24V3W
8GP 003 594-121	10	W5W, ECE-R 37, bulb cap W 2.1 x 9.5 d, 12V5W
8GP 003 594-123	1	12V5W, 2 pieces, carded
8GP 003 594-261	10	12V5W Blue Light, in pairs only
8GP 003 594-263	1	12V5W Blue Light, in pairs only, 2 pieces, carded
8GP 003 594-251	10	24V5W
8GP 003 594-258	1	24V5W, 2 pieces, carded

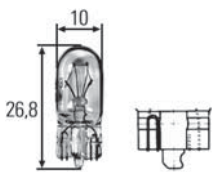

For dashboard lighting

Part no.	Pk.	
8GA 008 901-241	10	Bulb cap W 2.1 x 9.5 d, 24V2W

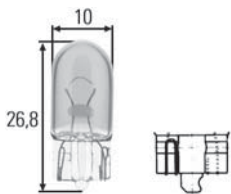

For position lights, rear fog lights and reversing lights

Part no.	Pk.	
8GP 003 594-541	10	WY5W, ECE-R 37, bulb cap W 2.1 x 9.5 d, 12V5W amber
8GP 003 594-543	1	12V5W, amber, 2 pieces, carded

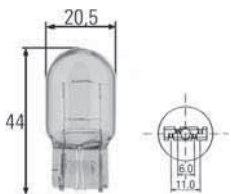

For indicator lights, stop lights, rear fog lights and reversing lights

Part no.	Pk.	
8GP 009 021-002	10	WY21W, ECE-R 37, bulb cap W 3 x 16 d, 12V21W, yellow

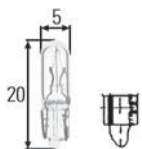

For warning lights and switches

Part no.	Pk.	
8GP 002 095-121	10	W1.2W, DIN 72 601, bulb cap W 2 x 4.6 d, 12V1.2W
8GP 002 095-241	10	24V1.2W

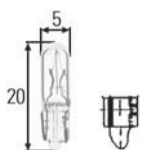

For safety brake lights

Part no.	Pk.	
8GP 938 026-001	10	W2.3W, ECE-R 37, bulb cap W 2 x 4.6 d, 12V2.3W

Fluorescent tubes

For ceiling lights

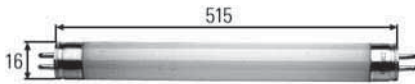

Part no.	Pk.	
8GS 002 296-111	1	TL, bulb cap G5/11x15 Light flux 450 lm, 4000 Kelvin, 8W, Light colour 25, cold white, 12V/24V8W
8GS 002 296-101	1	Light flux > 300 lm, 2950° Kelvin, 8W, Light colour 32, soft glow, 12V/24V8W
8GS 861 953-011	1	Light flux 850 lm, 3450° Kelvin, 13W, Light colour 35, white, 12V/24V13W

For interior lights



Part no.	Pk.	
8GS 861 955-001	1	PL, bulb cap 2G7, 4000° Kelvin, cold white, 113 mm, 12V/24V7W
8GS 861 955-011	1	4000° Kelvin, cold white, 144 mm, 12V/24V9W
8GS 861 955-021	1	4000° Kelvin, cold white, 212 mm, 12V/24V11W
8GS 861 955-031	1	2700° Kelvin, cold white, 212 mm, 12V/24V11W

Bulb with glass cap

For dashboard lighting

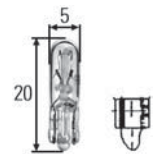

Part no.	Pk.	
8GA 007 997-181	10	Bulb cap W 2 x 4.6 d, 24V2W

Bulbs with plastic caps

For dashboard and interior lighting



Part no.	Pk.	
8GA 007 997-011	10	Bulb cap W 2 x 4.6 d, white, 12V1.2W
8GA 007 997-021	10	24V1W

For dashboard and interior lighting



Part no.	Pk.	
8GA 007 997-001	10	Bulb cap B 8.3 d, white, 12V2W
8GA 007 997-061	10	Bulb cap B 8.3 d, grey, 24V1.2W
8GA 007 997-041	10	Bulb cap B 8.3 d, black, 12V1.2W

Bulbs with plastic caps

For dashboard and interior lighting

Part no.	Pk.	
8GA 007 997-161	10	Bulb cap B 8.5 d, beige, 12V1.5W
8GA 007 997-071	10	Bulb cap B 8.5 d, grey, 24V1.2W
8GA 007 997-081	10	Bulb cap B 8.5 d, green, 12V2W



For dashboard and interior lighting

Part no.	Pk.	
8GA 007 997-051	10	Bulb cap B 8.7 d, grey, 12V1.2W
8GA 007 997-091	10	Bulb cap B 8.7 d, green, 12V2W



For dashboard and interior lighting

Part no.	Pk.	
		Mini-halogen.
8GA 007 997-101	10	Bulb cap B 10 d, brown, 12V3W
8GA 007 997-111	10	12V5W



Bulbs with plastic caps

For dashboard and interior lighting



Part no.	Pk.	
8GA 007 997-121	10	Bulb cap BX 8.4 d, black, 12V1.2W
8GA 007 997-131	10	Bulb cap BX 8.4 d, green, 12V1.3W
8GA 007 997-141	10	Bulb cap BX 8.4 d, beige, 2V1.5W
8GA 007 997-171	10	Bulb cap BX 8.4 d, amber, 12V1.1W
8GS 006 677-121	10	Bulb cap BX 8.4 d, white/green 12V2W

For dashboard and interior lighting



Part no.	Pk.	
8GA 007 997-151	10	Bulb cap BX 8.5 d, blue violet, 12V0.36W
8GA 007 997-211	10	Bulb cap BX 8.5 d, light blue, 12V1.2W
8GA 007 997-221	10	Bulb cap BX 8.5 d, light green, 12V2W
8GA 007 997-261	10	Bulb cap BX 8.5 d, brown, 24V1.2W

Bulbs with plastic caps

For dashboard and interior lighting

Part no.	Pk.	
8GA 007 997-191	10	Bulb cap EBS R4, yellow, 24V1.2W
8GA 007 997-201	10	Bulb cap EBS R6, brown, 24V1.2W
8GA 007 997-272	10	Bulb cap EBS N10, beige, 24V1.2W



For dashboard and interior lighting

Part no.	Pk.	
8GA 007 997-231	10	Bulb cap BG 8.5 - 5.5 d, black, 12V1.2W



For dashboard and interior lighting

Part no.	Pk.	
8GA 007 997-241	10	Bulb cap SG 8 - 5.5 d, black, 12V1.2W



Bulb holders

Part no.	Pk.	
9FF 085 081-001	10	Bulb cap BA 15 s, 1-pole, DIN 49 725, with blade terminal contact
9FF 138 324-001	10	Bulb cap BA 15 s, 1-pole, with blade terminal contact with screw-type contact
9FF 133 025-007	20	
9FF 071 116-001	10	Bulb cap BAY 15 d, 2-pole, with screw-type contact
9FF 078 830-001	10	Bulb cap BA 9 s, 1-pole
9FF 042 509-001	10	Bulb cap BA 7 s, 1-pole, with blade terminal contact
9FF 135 906-021	10	Bulb cap X 511, with blade terminal contacts

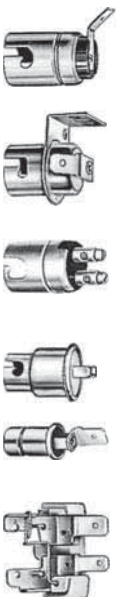

Connectors

Connector for H4 or R2 bulbs.

For lead cross-section 2.5 sq. mm.

Lead connection via clamping, can be released via push-buttons.



Part no.	Pk.	
8JA 001 909-001	10	3-pole connector, without earthing cable
8JA 001 909-011	10	with earthing cable 130 mm long
8JA 001 914-011	10	3-pole connector, with earthing lead 130 mm long

Connector for H3 bulbs

Part no.	Pk.	
8JA 990 295-217	10	HB3 connector

Plug with preinstalled leads and butt connectors for H1 bulbs.

To fit leads with max. cross-section up to 1.0 sq. mm .

Crimped lead connections.

Length of brown lead (earth): 60 mm.

Length of white lead: 40 mm.



Part no.	Pk.	
8KB 863 949-001	1	Connectors

Plug with preinstalled leads and butt connectors for H7 bulbs.

To fit leads with max. cross-section up to 1.0 sq. mm .

Crimped lead connections.

Length of brown lead (earth): 120 mm.

Length of white lead: 100 mm.



Part no.	Pk.	
8KB 863 949-011	1	Connectors

Plug with preinstalled leads for H7 bulbs.

To fit leads with max. cross-section up to 1.0 sq. mm .

Length of brown lead (earth): 130 mm.

Length of black lead: 150 mm.



Part no.	Pk.	
8KB 193 607-001	1	Connectors
8KB 193 607-002	10	



List of part- and type approval numbers Manufacturer's no. / HELLA no.

—	—	—
—	—	—
—	—	—
—	—	—
—	—	—
—	—	—
—	—	—
—	—	—
—	—	—
—	—	—

List of part numbers

5.02-5.13

Vehicle manufacturer's no. / HELLA no.

5.14-5.60

List of type approval numbers / HELLA numbers

5.62-5.72

List of HELLA numbers / type approval numbers

5.74-5.84

Note:

The original numbers listed in the manufacturer number - HELLA number comparison serve exclusively for comparison purposes and are not to be used otherwise.

List of part numbers



Part number	Page	Part number	Page	Part number	Page	Part number	Page
1A3...		1BA...		1EE...		1F8...	
1A3 001 120-001	1.59	1BA 996 261-021	1.85	1EE 996 174-277	1.80	1F8 007 560-211	1.23
1A3 002 850-001	1.58, 1.72	1BA 996 261-197	1.85	1EE 996 174-287	1.80	1F8 007 560-301	1.22
1A3 002 850-031	1.58, 1.72-1.73	1BL...		1EE 996 174-337	1.80	1F8 007 560-311	1.24
1A3 003 370-041	1.58	1BL 005 380-011	1.62	1EE 996 174-357	1.81	1F8 007 560-321	1.24
1A3 005 649-007	1.58	1BL 005 380-021	1.62	1EE 996 174-367	1.81	1F8 007 560-331	1.24
1A3 005 760-501	1.83	1BL 005 380-031	1.62	1EE 996 174-387	1.80	1F8 007 560-341	1.24
1A3 005 760-507	1.83	1BL 005 380-041	1.62	1EE 996 174-391	1.81	1F8 007 560-401	1.22
1A3 005 760-518	1.83	1BL 005 740-091	1.63	1EE 996 174-401	1.81	1F8 007 560-411	1.24
1A3 125 195-015	1.58	1BL 005 740-101	1.63	1EE 996 174-431	1.81	1F8 007 560-421	1.24
1A3 990 016-011	1.72	1BL 006 349-007	1.56	1EE 996 174-441	1.81	1F8 007 560-451	1.24
1A3 996 002-051	1.57	1BL 006 349-011	1.56	1EE 996 374-001	1.82	1F8 007 560-561	1.25
1A3 996 002-161	1.72	1BL 007 834-007	1.54	1EE 996 374-011	1.82	1F8 007 560-571	1.25
1A3 996 002-181	1.58	1BL 007 834-037	1.54	1EE 996 374-021	1.82	1F8 007 560-621	1.25
1A3 996 002-191	1.72	1BL 007 834-047	1.54	1F0...		1F8 007 560-631	1.25
1A3 996 002-211	1.58	1BL 007 834-132	1.54	1F0 008 390-001	1.36	1F8 007 560-721	1.25
1A3 996 002-261	1.57	1BL 008 193-001	1.41	1F0 008 390-301	1.38	1F8 007 560-731	1.25
1A3 996 002-531	1.58	1BL 008 193-007	1.41	1F0 008 390-317	1.38	1F8 009 797-021	1.20
1A3 996 026-011	1.73	1BL 008 193-011	1.41	1F0 008 390-327	1.38	1F8 009 797-031	1.20
1A3 996 026-021	1.73	1BL 008 193-017	1.41	1F0 008 390-801	1.36	1F8 009 797-101	1.20
1A3 996 026-121	1.73	1BL 008 193-172	1.41	1F0 008 390-821	1.38	1F8 009 797-111	1.20
1A3 996 162-071	1.57	1BL 008 194-001	1.42	1F0 010 293-001	1.41	1F8 009 797-121	1.20
1A3 996 162-321	1.57	1BL 008 194-007	1.42	1F0 011 988-021	1.52	1F8 009 797-131	1.20
1A3 996 162-381	1.57	1BL 008 194-027	1.42	1F0 011 988-031	1.52	1F8 009 797-321	1.20
1A3 996 162-607	1.72	1BL 009 071-001	1.39	1F0 011 988-071	1.53	1F8 009 797-331	1.20
1A5...		1BL 009 071-007	1.39	1F0 011 988-081	1.53	1F8 009 797-341	1.20
1A5 003 178-231	1.74	1BL 009 071-047	1.39	1F0 011 988-121	1.52	1F8 009 797-421	1.20
1A5 003 178-401	1.74	1BL 009 071-067	1.39	1F0 011 988-131	1.52	1F8 009 797-431	1.20
1A5 003 178-411	1.74	1BL 009 071-107	1.39	1F0 011 988-171	1.53	1F8 009 797-451	1.20
1A5 003 190-001	1.74	1BL 009 999-001	1.49	1F0 011 988-181	1.53	1F8 011 002-001	1.26
1A5 118 740-001	1.74	1BL 009 999-041	1.49	1F0 012 206-001	1.17	1F8 011 002-011	1.26
1A6...		1BL 010 820-001	1.50	1F0 012 206-011	1.17	1F8 147 077-011	1.18
1A6 001 128-061	1.60	1BL 010 820-801	1.50	1F0 012 206-112	1.17	1F8 148 009-011	1.22
1A6 002 395-031	1.60	1BL 010 820-811	1.50	1F0 996 376-181	1.10	1F8 148 131-011	1.22, 1.24
1A6 002 395-071	1.60	1BL 012 488-001	1.46	1F1...		1F8 149 644-011	1.25
1A6 002 395-077	1.60	1BL 012 488-021	1.46	1F1 009 094-041	1.14	1F8 157 042-011	1.19
1A6 002 395-077	1.60	1BL 012 488-101	1.46	1F1 009 094-051	1.14	1F8 158 926-011	1.24
1A6 002 395-387	1.60	1BL 012 488-121	1.46	1F1 009 094-091	1.14	1F8 161 326-011	1.18, 1.20, 1.23
1A6 002 395-821	1.60	1BL 139 277-031	1.56	1F1 161 825-021	1.14	1F8 162 870-011	1.20, 1.22, 1.24
1A7...		1BL 139 278-031	1.56	1F1 161 825-041	1.14	1F8 162 870-031	1.20, 1.22, 1.24
1A7 003 099-001	1.75	1BL 158 060-021	1.42	1F3...		1F8 162 871-011	1.20, 1.24
1A7 003 099-011	1.75	1BL 247 042-001	1.44	1F3 009 094-021	1.15	1F8 162 871-021	1.18
1A7 117 596-001	1.75	1BL 247 042-007	1.44	1F3 009 094-031	1.15	1F8 162 871-011	1.18
1A7 118 750-001	1.75	1BL 247 042-011	1.44	1F3 009 094-061	1.15	1F8 162 874-011	1.19
1AA...		1BL 247 042-017	1.46	1F3 009 094-071	1.15	1F8 165 940-011	1.19
1AA 004 109-001	1.66	1BL 247 042-157	1.46	1F3 009 094-142	1.16	1F8 165 941-011	1.18
1AA 004 109-021	1.66	1BL 247 042-177	1.46	1F3 009 094-171	1.15	1F8 165 942-011	1.19
1AA 004 109-031	1.66	1BL 247 042-217	1.44	1F3 009 094-311	1.16	1F8 165 943-011	1.18
1AA 004 109-041	1.66	1BL 998 570-001	1.40	1F3 010 119-001	1.21	1F8 165 946-011	1.20, 1.24
1AA 004 109-201	1.66	1DL...		1F3 010 119-011	1.21	1F8 165 947-011	1.20, 1.24
1AA 126 924-035	1.66	1DL 005 600-097	1.65	1F3 010 119-021	1.21	1F8 165 949-011	1.25
1AA 127 473-015	1.66	1DL 005 600-107	1.65	1F3 010 119-101	1.21	1F8 165 951-011	1.25
1AA 143 897-011	1.79	1DL 007 872-017	1.65	1F3 010 119-111	1.21	1F8 173 055-021	1.25
1AB...		1DL 007 872-027	1.65	1F3 010 119-121	1.21	1F8 181 541-011	1.26
1AB 001 100-001	1.66	1DL 007 872-037	1.65	1F3 011 815-001	1.16	1FA...	
1AB 003 177-001	1.60	1DL 007 872-047	1.65	1F3 011 815-011	1.16	1FA 007 133-021	1.29
1AB 003 177-011	1.60, 1.79	1DL 007 872-077	1.65	1F3 011 815-031	1.16	1FA 007 891-061	1.28
1AB 003 177-611	1.61	1DL 007 872-087	1.65	1F3 161 825-011	1.15, 1.21	1FA 007 891-811	1.28
1AB 003 177-791	1.60	1E3...		1F3 161 825-031	1.15, 1.21	1FA 007 891-841	1.28
1AB 004 231-001	1.79	1E3 996 160-637	1.71	1F3 161 825-071	1.16	1FA 008 283-011	1.27
1AB 006 213-001	1.102	1E3 996 160-647	1.71	1F3 161 825-081	1.15, 1.21	1FA 008 283-031	1.27
1AB 006 213-011	1.102, 1.106	1E3 996 160-671	1.71	1F4...		1FA 008 283-811	1.27
1AB 006 213-027	1.102	1E3 996 160-681	1.71	1F4 002 608-001	1.12	1FA 008 283-861	1.27
1AB 006 277-127	1.62	1E5...		1F4 005 750-071	1.12	1FA 008 284-011	1.27
1AB 006 977-021	1.61	1E5 996 124-001	1.73	1F4 005 750-101	1.12	1FA 008 284-031	1.27
1AB 007 145-001	1.107	1EA...		1F4 005 750-611	1.12	1FA 008 284-811	1.27
1AB 007 145-007	1.107	1EA 007 108-011	1.79	1F4 005 750-811	1.12	1FA 008 284-861	1.27
1AB 008 888-041	1.62	1EA 007 108-017	1.79	1F4 005 750-871	1.12	1FA 010 047-011	1.26
1AB 008 888-051	1.62	1EA 007 108-021	1.79	1F4 007 893-021	1.11	1FA 010 047-801	1.26
1AB 990 335-111	1.70	1EA 007 108-027	1.79	1F4 007 893-081	1.11	1FA 149 504-011	1.28
1AB 996 157-081	1.100	1EA 007 108-027	1.79	1F4 007 893-141	1.12	1FB...	
1AB 996 157-091	1.100	1EA 990 185-021	1.76-1.78	1F4 007 893-201	1.11	1FB 005 860-031	1.30
1AB 996 157-131	1.101	1EA 993 975-011	1.76	1F4 007 893-241	1.11	1FB 005 860-061	1.30
1AB 996 157-151	1.101	1EA 993 975-017	1.76	1F4 007 893-811	1.11	1FB 005 860-831	1.30
1AB 996 213-001	1.106	1EA 993 975-021	1.76	1F4 007 893-841	1.11	1FB 007 892-011	1.29
1AD...		1EA 993 975-027	1.76	1F4 007 893-871	1.12	1FB 007 892-071	1.29
1AD 003 305-001	1.63	1EA 993 975-051	1.76	1F4 007 893-911	1.11	1FB 007 892-131	1.29
1AD 996 018-001	1.102	1EA 993 975-057	1.76	1F4 007 893-921	1.11	1FB 007 892-811	1.29
1AD 996 018-641	1.102	1EA 993 975-061	1.76	1F4 135 230-011	1.12	1FB 007 892-841	1.29
1AD 996 018-651	1.102	1EA 993 975-067	1.76	1F4 149 537-011	1.11	1FB 007 892-811	1.29
1AE...		1EA 993 975-091	1.76	1F4 157 022-011	1.12	1FB 010 951-001	1.30
1AE 003 427-011	1.63	1EA 993 975-097	1.76	1F4 160 302-011	1.11	1FB 010 951-011	1.30
1AE 003 427-021	1.63, 1.79	1EA 993 975-101	1.76	1F5...		1FB 010 951-821	1.30
1AE 003 427-151	1.64	1EA 993 975-107	1.76	1F5 008 273-041	1.17	1FB 010 951-821	1.30
1AE 003 427-161	1.64	1EA 993 975-337	1.76	1F5 154 875-011	1.17	1FB 149 519-011	1.29
1AE 004 234-001	1.79	1EA 993 975-347	1.76	1F6...		1FB 187 883-001	1.30
1AG...		1EA 993 975-397	1.76	1F6 010 952-001	1.13	1FD...	
1AG 003 434-051	1.67	1EA 996 074-051	1.68	1F6 010 952-011	1.13	1FD 003 590-411	1.31
1AG 003 434-137	1.67	1EA 996 074-061	1.68	1F6 010 952-801	1.13	1FD 005 700-051	1.31
1AG 003 434-251	1.67	1EA 996 074-177	1.68	1F6 010 952-821	1.13	1FD 005 700-301	1.31
1AL...		1EA 996 081-171	1.77	1F7...		1FD 005 700-851	1.31
1AL 008 934-001	1.47	1EA 996 081-177	1.77	1F7 004 700-431	1.17	1FD 010 953-001	1.32
1AL 008 934-021	1.47	1EA 996 127-001	1.78	1F8...		1FD 010 953-011	1.32
1AL 009 997-001	1.48	1EA 996 127-007	1.78	1F8 006 800-191	1.18	1FD 010 953-801	1.32
1AL 009 997-041	1.48	1EA 996 127-051	1.78	1F8 006 800-221	1.19	1FD 135 198-011	1.31
1AL 009 998-001	1.48	1EA 996 127-077	1.78	1F8 006 800-221	1.19	1FE...	
1AL 009 998-041	1.48	1EB...		1F8 006 800-301			



List of part numbers

Part number	Page	Part number	Page	Part number	Page	Part number	Page
1FE...		1G8...		1GA...		1GB...	
1FE 008 773-081	1.34	1G8 002 340-011	1.183	1GA 996 192-021	1.148	1GB 996 158-081	1.101
1FE 138 520-011	1.33	1G8 132 233-011	1.183	1GA 996 192-041	1.148	1GB 996 186-051	1.115
1FE 158 877-011	1.33	1G9...		1GA 996 192-051	1.147	1GB 996 186-061	1.115
1FE 161 576-011	1.34	1G9 001 523-021	1.185	1GA 996 192-061	1.148	1GB 996 194-001	1.149
1FE 161 641-011	1.34	1GA...		1GA 996 192-081	1.147	1GB 996 194-011	1.149
1FE 161 641-021	1.34	1GA 005 060-001	1.110	1GA 996 192-127	1.146	1GB 996 194-041	1.149
1FE 161 642-011	1.34	1GA 005 060-041	1.110	1GA 996 192-157	1.146	1GB 996 213-511	1.106
1FE 161 644-011	1.34	1GA 005 060-337	1.110	1GA 996 192-181	1.147	1GB 996 386-001	1.116
1FJ...		1GA 006 875-001	1.112	1GA 996 192-261	1.146	1GB 996 386-002	1.116
1FJ 958 040-001	1.34	1GA 006 876-001	1.111	1GA 996 196-001	1.140	1GB 996 386-021	1.116
1FJ 958 040-051	1.34	1GA 006 991-021	1.108	1GA 996 196-021	1.140	1GD...	
1G0...		1GA 006 991-031	1.109	1GA 996 196-031	1.140	1GD 003 590-701	1.114
1G0 357 000-001	1.194	1GA 006 991-041	1.109	1GA 996 196-041	1.140	1GD 003 690-287	1.114
1G0 357 002-001	1.194	1GA 006 991-051	1.108	1GA 996 196-051	1.140	1GD 005 700-501	1.114
1G0 995 050-001	1.162	1GA 006 991-061	1.108	1GA 996 242-111	1.123	1GD 006 018-541	1.105
1G0 995 050-011	1.162	1GA 006 991-071	1.109	1GA 996 242-521	1.123	1GD 996 193-001	1.113
1G0 995 050-021	1.162	1GA 006 991-081	1.109	1GA 996 242-541	1.122	1GD 996 193-011	1.113
1G0 996 163-087	1.174	1GA 006 991-091	1.108	1GA 996 261-511	1.96	1GD 996 193-051	1.113
1G0 996 176-001	1.164	1GA 007 506-001	1.125	1GA 996 261-521	1.96	1GD 996 193-071	1.113
1G0 996 176-002	1.164	1GA 007 506-002	1.125	1GA 996 261-531	1.97	1GJ...	
1G0 996 176-007	1.164	1GA 007 506-007	1.125	1GA 996 261-561	1.97	1GJ 011 872-011	1.184
1G0 996 176-011	1.164	1GA 007 506-011	1.127	1GA 996 261-571	1.97	1GJ 011 872-021	1.184
1G0 996 176-021	1.163	1GA 007 506-012	1.127	1GA 996 261-581	1.98	1GJ 011 872-031	1.184
1G0 996 176-031	1.163	1GA 007 506-021	1.129	1GA 996 261-691	1.97	1GL...	
1G0 996 176-041	1.165	1GA 007 506-061	1.124	1GA 996 261-701	1.97	1GL 008 090-201	1.161
1G0 996 176-051	1.165	1GA 007 506-081	1.125	1GA 996 261-711	1.97	1GL 008 090-207	1.161
1G0 996 176-061	1.166	1GA 007 506-091	1.127	1GA 996 283-001	1.141	1GL 008 090-211	1.161
1G0 996 176-111	1.164	1GA 007 506-101	1.129	1GA 996 283-002	1.141	1GL 008 090-217	1.161
1G0 996 176-112	1.164	1GA 007 506-111	1.124	1GA 996 283-011	1.141	1GL 008 090-217	1.161
1G0 996 176-121	1.164	1GA 007 506-121	1.124	1GA 996 283-031	1.141	1GL 008 090-287	1.161
1G0 996 176-131	1.165	1GA 007 506-122	1.124	1GA 996 283-041	1.141	1GM...	
1G0 996 176-137	1.165	1GA 007 506-391	1.125	1GA 996 288-001	1.143	1GM 996 134-051	1.158
1G0 996 176-137	1.165	1GA 007 506-431	1.124	1GA 996 288-011	1.143	1GM 996 134-061	1.158
1G0 996 176-141	1.165	1GA 007 506-451	1.128	1GA 996 288-012	1.143	1GM 996 134-071	1.158
1G0 996 176-171	1.165	1GA 007 506-491	1.128	1GA 996 288-021	1.143	1GM 996 134-081	1.158
1G0 996 176-181	1.165	1GA 007 506-547	1.126	1GA 996 288-031	1.143	1GM 996 134-081	1.158
1G0 996 176-621	1.166	1GA 007 506-651	1.128	1GA 996 288-041	1.143	1GM 996 134-091	1.153
1G0 996 176-671	1.165	1GA 007 506-681	1.129	1GA 996 288-147	1.143	1GM 996 134-171	1.158
1G0 996 176-681	1.167	1GA 010 467-001	3.37-3.42, 3.44-3.47, 3.49-3.52, 3.63-3.70	1GA 996 288-171	1.143	1GM 996 134-241	1.159
1G0 996 176-691	1.167			1GA 996 361-011	1.94	1GM 996 134-271	1.159
1G0 996 263-001	1.175	1GA 011 720-041	1.151	1GA 996 361-171	1.93	1GM 996 134-311	1.153
1G0 996 263-011	1.175	1GA 132 459-011	1.110	1GA 996 361-421	1.93	1GM 996 134-321	1.158
1G0 996 263-031	1.176	1GA 357 001-001	1.194	1GA 996 361-431	1.87	1GM 996 134-371	1.159
1G0 996 263-051	1.176	1GA 980 670-231	1.115	1GA 996 361-447	1.90	1GM 996 135-041	1.155
1G0 996 263-501	1.174	1GA 980 670-331	1.115	1GA 996 361-497	1.90	1GM 996 135-051	1.155
1G0 996 276-071	1.170	1GA 990 305-001	1.118-1.119, 1.123	1GA 996 361-501	1.93	1GM 996 135-231	1.157
1G0 996 276-187	1.165	1GA 990 305-061	1.118-1.119	1GA 996 361-581	1.88	1GM 996 135-241	1.157
1G0 996 276-357	1.167	1GA 990 305-071	1.120, 1.185	1GA 996 388-001	1.144	1GM 996 135-251	1.157
1G0 996 276-451	1.171	1GA 995 193-001	1.152	1GA 996 388-011	1.144	1GM 996 135-261	1.157
1G0 996 276-453	1.171	1GA 995 193-011	1.152	1GA 996 388-021	1.144	1GM 996 135-361	1.156
1G0 996 276-461	1.171	1GA 995 193-021	1.152	1GA 996 388-031	1.144	1GM 996 135-551	1.154
1G0 996 276-481	1.171	1GA 995 193-031	1.152	1GA 996 461-261	1.99	1GM 996 136-131	1.160
1G0 996 276-487	1.171	1GA 995 193-041	1.152	1GA 996 461-311	1.99	1GM 996 136-192	1.160
1G0 996 276-631	1.171	1GA 995 506-001	1.138	1GA 996 461-321	1.99	1GM 996 136-311	1.160
1G0 996 276-701	1.172	1GA 995 506-002	1.138	1GA 996 461-331	1.99	1GM 996 136-312	1.160
1G0 996 276-767	1.163	1GA 995 506-011	1.138	1GA 996 461-341	1.99	1GM 996 136-361	1.160
1G0 996 376-137	1.171	1GA 995 506-021	1.138	1GA 996 461-547	1.93	1GN...	
1G0 996 376-141	1.168	1GA 995 506-031	1.139	1GA 996 461-747	1.91	1GN 996 361-461	1.91
1G0 996 376-501	1.170	1GA 995 506-041	1.138	1GA 996 461-787	1.99	1H3...	
1G0 996 476-001	1.173	1GA 995 506-051	1.139	1GA 996 461-797	1.99	1H3 002 456-012	1.192
1G0 996 476-011	1.173	1GA 995 506-061	1.138	1GA 996 561-007	1.95	1H3 002 456-032	1.192
1G0 996 476-021	1.173	1GA 995 506-071	1.139	1GA 996 561-357	1.90	1H5...	
1G0 996 476-031	1.173	1GA 995 506-101	1.139	1GA 996 661-001	1.100	1H5 998 502-002	1.191
1G0 996 476-041	1.169	1GA 996 020-001	1.117	1GA 996 661-002	1.100	1H5 998 502-022	1.191
1G0 996 476-121	1.169	1GA 996 082-001	1.113	1GA 996 661-011	1.100	1H5 998 502-051	1.191
1G0 996 476-131	1.169	1GA 996 083-001	1.130	1GA 996 661-021	1.89	1H5 998 502-067	1.191
1G0 996 476-231	1.173	1GA 996 083-011	1.130	1GA 996 661-061	1.89	1K0...	
1G0 996 476-241	1.173	1GA 996 142-001	1.118	1GA 997 506-021	1.126	1K0 008 191-001	1.42
1G3...		1GA 996 142-011	1.118	1GA 997 506-157	1.130	1K0 008 191-007	1.42
1G3 003 710-021	1.177	1GA 996 142-021	1.118	1GA 997 506-217	1.126	1K0 008 191-011	1.42
1G3 005 760-001	1.84	1GA 996 142-041	1.119	1GA 997 506-227	1.126	1K0 008 191-017	1.42
1G3 005 760-011	1.84	1GA 996 142-061	1.120	1GA 997 506-371	1.125	1K0 008 191-021	1.42
1G3 005 760-021	1.83	1GA 996 142-071	1.120	1GA 997 506-631	1.127	1K0 008 191-027	1.42
1G3 005 760-031	1.84	1GA 996 142-081	1.120	1GA 997 506-661	1.125	1K0 008 191-041	1.42
1G3 005 760-041	1.85	1GA 996 142-091	1.120	1GA 998 522-011	1.111	1K0 008 191-047	1.42
1G3 005 760-051	1.85	1GA 996 142-131	1.120	1GA 998 522-407	1.111	1K0 008 191-212	1.42
1G3 005 760-201	1.84	1GA 996 142-141	1.119	1GA 998 524-001	1.108	1K0 008 191-217	1.42
1G3 005 760-211	1.84	1GA 996 142-151	1.121	1GA 998 525-001	1.124-1.125, 1.127-1.130	1K0 008 192-001	1.43
1G3 005 760-221	1.83	1GA 996 142-221	1.185	1GA 998 525-011	1.133	1K0 008 192-007	1.43
1G3 005 760-227	1.83	1GA 996 142-251	1.121	1GA 998 532-011	1.117	1K0 008 192-011	1.43
1G3 135 211-011	1.83-1.84	1GA 996 142-311	1.118	1GA 998 534-001	1.133	1K0 008 192-017	1.43
1G3 141 019-011	1.85	1GA 996 142-371	1.119	1GA 998 534-011	1.133	1K0 008 192-027	1.43
1G3 996 001-001	1.178	1GA 996 142-381	1.121	1GA 998 534-221	1.134	1K0 008 192-091	1.43
1G3 996 001-041	1.178	1GA 996 150-021	1.131	1GA 998 534-231	1.134	1K0 158 059-061	1.43
1G3 996 001-131	1.178	1GA 996 150-071	1.131	1GA 998 534-271	1.134	1K0 158 059-071	1.43
1G3 996 001-271	1.179	1GA 996 150-081	1.131	1GA 998 534-431	1.136	1K0 247 043-001	1.45
1G3 996 001-301	1.179	1GA 996 150-151	1.132	1GA 998 534-441	1.136	1K0 247 043-007	1.45
1G3 996 001-331	1.179	1GA 996 161-101	1.87	1GA 998 534-451	1.136	1K0 247 043-011	1.45
1G3 996 001-351	1.179	1GA 996 161-111	1.86	1GA 998 534-461	1.136	1K0 247 043-017	1.45
1G3 996 001-391	1.178	1GA 996 161-121	1.93	1GA 998 534-491	1.137	1K0 247 043-021	1.45
1G4...		1GA 996 161-131	1.94	1GA 998 534-541	1.132	1K0 247 043-027	1.45
1G4 003 470-001	1.180	1GA 996 161-281	1.90	1GA 998 534-601	1.137	1K0 247 043-031	1.45
1G4 003 470-011	1.180	1GA 996 161-291	1.92	1GA 998 534-671	1.135	1K0 247 043-037	1.45
1G4 003 470-031							

List of part numbers



Part number	Page	Part number	Page	Part number	Page	Part number	Page
1KA...		1NL...		2BA...		2BA...	
1KA 996 261-091	1.85	1NL 008 090-397	1.38	2BA 008 221-041	2.77	2BA 980 888-411	2.140
1KB...		1NL 008 090-821	1.36	2BA 008 221-047	2.77	2BA 980 888-511	2.140
1KB 003 177-061	1.61	1S0...		2BA 008 221-107	2.77	2BA 980 888-611	2.140
1KL...		1S0 001 430-011	1.69	2BA 008 221-147	2.77	2BA 996 012-061	2.120
1KL 007 834-027	1.54	1S3...		2BA 008 221-217	2.77	2BA 996 012-071	2.120
1KL 007 834-067	1.54	1S3 001 117-041	1.69	2BA 008 260-001	2.212	2BA 996 012-147	2.120
1KL 009 486-001	1.39	1S3 001 440-00	1.68	2BA 008 260-007	2.212	2BA 996 027-001	2.211
1KL 998 570-021	1.40	1S3 001 442-001	1.68	2BA 008 805-051	2.132	2BA 997 027-031	2.139
1KL 998 570-031	1.40	1TA...		2BA 008 805-057	2.132	2BE...	
1NO...		1TA 003 570-001	1.67	2BA 008 805-187	2.132	2BE 001 259-061	2.114
1NO 008 582-001	1.40	1TA 003 570-101	1.75	2BA 008 805-211	2.131	2BE 001 278-011	2.219
1NO 008 582-007	1.40	1TA 122 718-001	1.67	2BA 008 805-257	2.132	2BE 001 278-021	2.219
1NO 008 582-011	1.40	1VB...		2BA 008 982-041	2.130	2BE 002 582-031	2.67
1NO 008 582-017	1.40	1VB 005 444-037	1.61	2BA 008 982-047	2.130	2BE 002 776-251	2.72
1NO 008 582-037	1.40	1XA...		2BA 008 982-341	2.130	2BE 002 776-257	2.72
1NO 008 582-042	1.40	1XA 010 410-001	3.63-3.70	2BA 008 982-347	2.130	2BE 002 776-261	2.72
1NO 009 295-011	1.10	2AA...		2BA 009 001-001	2.84	2BE 002 776-267	2.72
1NO 009 295-021	1.10	2AA 001 200-001	2.251	2BA 009 001-007	2.84	2BE 003 014-251	2.119
1NO 009 295-031	1.10	2AA 001 200-011	2.251	2BA 009 001-071	2.84	2BE 003 014-257	2.119
1NO 009 295-037	1.10	2AA 001 200-012	2.251	2BA 009 001-077	2.84	2BE 003 018-011	2.73
1NO 009 295-041	1.10	2AA 001 200-021	2.251	2BA 009 001-107	2.84	2BE 003 182-091	2.71
1NO 009 295-047	1.10	2AA 001 200-023	2.251	2BA 009 001-167	2.84	2BE 003 182-101	2.71
1NO 009 295-057	1.10	2AA 001 200-031	2.251	2BA 009 001-191	2.84	2BE 003 184-051	2.68
1NO 009 295-067	1.10	2AA 001 200-041	2.251	2BA 009 001-201	2.84	2BE 003 184-061	2.68
1NO 009 295-801	1.10	2AA 001 200-131	2.251	2BA 009 001-411	2.81	2BE 003 185-031	2.73
1NO 010 294-001	1.41	2AA 001 200-141	2.251	2BA 009 001-431	2.81	2BE 003 347-001	2.219
1NO 010 294-011	1.41	2AA 001 200-151	2.251	2BA 009 001-511	2.81	2BE 004 119-021	2.134
1NO 011 988-001	1.51	2AA 001 201-011	2.251	2BA 009 001-531	2.81	2BE 010 102-001	2.218
1NO 011 988-011	1.51	2AA 001 201-011	2.251	2BA 009 001-737	2.84	2BE 010 102-011	2.218
1NO 011 988-051	1.51	2AA 001 204-001	2.250	2BA 009 204-041	2.212	2BE 010 102-101	2.218
1NO 011 988-061	1.51	2AA 001 204-011	2.250	2BA 009 204-051	2.212	2BE 343 130-001	2.112
1N4...		2AA 001 204-031	2.250	2BA 009 204-057	2.212	2BE 343 130-007	2.112
1N4 002 608-021	1.12	2AA 003 257-001	2.251	2BA 011 172-001	2.75	2BE 343 130-081	2.112
1N4 005 750-041	1.12	2AA 003 257-011	2.251	2BA 011 172-007	2.75	2BE 343 130-411	2.110
1N4 005 750-601	1.12	2AA 003 257-021	2.251	2BA 011 172-011	2.75	2BE 343 130-417	2.110
1N4 007 893-001	1.11	2AA 003 257-021	2.251	2BA 011 172-017	2.75	2BE 343 130-421	2.110
1N4 007 893-821	1.11	2AA 003 257-031	2.251, 3.25	2BA 011 172-021	2.75	2BE 343 130-427	2.110
1N4 135 224-011	1.12	2AA 003 257-041	2.251	2BA 011 172-027	2.75	2BE 343 130-657	2.109
1N4 149 531-011	1.11	2AA 003 257-042	2.251	2BA 011 172-031	2.75	2BE 343 130-667	2.109
1N6...		2AA 008 592-021	2.250	2BA 011 172-037	2.75	2BE 343 130-777	2.109
1N6 010 952-101	1.13	2AA 008 592-031	2.250	2BA 011 172-147	2.75	2BE 343 130-787	2.109
1N6 010 952-111	1.13	2AA 008 594-001	2.250	2BA 011 172-401	2.75	2BE 344 130-777	2.107
1N6 010 952-811	1.13	2AA 008 594-011	2.250	2BA 011 172-407	2.75	2BE 357 022-001	2.345
1N8...		2AA 008 594-021	2.250	2BA 011 172-411	2.75	2BE 357 023-001	2.346
1N8 006 800-001	1.18	2AA 008 594-031	2.250	2BA 011 172-417	2.75	2BE 357 027-061	2.355
1N8 007 560-021	1.24	2AA 008 595-021	2.250	2BA 011 172-421	2.75	2BE 357 028-051	2.356
1N8 007 560-031	1.22	2AA 008 595-031	2.250	2BA 011 172-427	2.75	2BE 357 032-001	2.347
1N8 148 103-011	1.22, 1.24	2AB...		2BA 011 172-431	2.75	2BE 357 032-001	2.347
1NA...		2AB 001 208-001	2.246	2BA 011 172-437	2.75	2BE 959 932-131	2.212
1NA 007 133-001	1.29	2AB 004 074-027	2.246	2BA 013 236-011	2.121	2BE 964 169-071	2.102
1NA 007 891-041	1.28	2AB 004 532-001	2.244	2BA 013 236-021	2.121	2BE 964 169-077	2.102
1NA 007 891-821	1.28	2AB 004 532-011	2.244	2BA 013 236-131	2.124	2BE 980 690-001	2.218
1NA 008 283-001	1.27	2AB 004 532-021	2.244	2BA 013 236-141	2.124	2BE 980 690-101	2.218
1NA 008 283-801	1.27	2AB 004 532-031	2.244	2BA 013 236-181	2.123	2BE 980 690-301	2.90, 2.309
1NA 008 284-001	1.27	2AB 004 532-051	2.244	2BA 013 236-191	2.123	2BE 980 691-001	2.218
1NA 008 284-801	1.27	2AB 004 532-057	2.244	2BA 013 236-211	2.121	2BE 980 691-101	2.218
1NA 010 047-101	1.26	2AB 004 532-061	2.244	2BA 013 236-221	2.121	2BE 987 006-101	2.70
1NA 010 047-101	1.26	2AB 004 532-257	2.244	2BA 013 236-331	2.124	2BE 997 131-081	2.69
1NA 010 047-811	1.26	2AB 004 532-297	2.244	2BA 013 236-341	2.124	2BE 997 131-207	2.69
1NB...		2BA...		2BA 013 236-381	2.123	2BM...	
1NB 004 691-147	1.61	2BA 001 221-031	2.210	2BA 013 236-391	2.123	2BM 001 313-001	2.215
1NB 005 860-021	1.30	2BA 001 221-041	2.210	2BA 302 252-027	2.88	2BM 001 313-821	2.215
1NB 005 860-131	1.30	2BA 001 227-201	2.208	2BA 343 130-051	2.112	2BM 001 318-001	2.215
1NB 005 860-801	1.30	2BA 001 227-211	2.208	2BA 343 130-057	2.112	2BM 002 652-031	2.209
1NB 007 892-001	1.29	2BA 001 236-001	2.213	2BA 343 130-297	2.109	2BM 002 652-051	2.209
1NB 007 892-041	1.29	2BA 001 240-301	2.104	2BA 343 130-307	2.109	2BM 002 847-011	2.214
1NB 007 892-821	1.29	2BA 001 244-001	2.210	2BA 343 130-537	2.109	2BM 002 847-021	2.214
1NB 010 951-101	1.30	2BA 001 248-001	2.208	2BA 343 130-547	2.109	2BM 003 647-021	2.214
1NB 010 951-111	1.30	2BA 001 259-611	2.115	2BA 343 130-577	2.112	2BM 003 647-067	2.214
1NB 010 951-831	1.30	2BA 001 259-618	2.115	2BA 343 390-071	2.106	2BM 004 312-051	2.214
1NB 137 001-021	1.30	2BA 001 263-001	2.213	2BA 344 130-237	2.112	2BM 004 312-061	2.214
1NB 187 883-101	1.30	2BA 001 277-011	2.210	2BA 344 130-247	2.112	2BM 004 965-801	2.214
1ND...		2BA 001 277-021	2.210	2BA 344 130-747	2.107	2BM 006 692-011	2.217
1ND 003 590-401	1.31	2BA 001 416-021	2.211	2BA 344 169-007	2.97	2BM 006 692-017	2.217
1ND 005 700-001	1.31	2BA 001 416-021	2.211	2BA 344 169-027	2.100	2BM 006 692-021	2.217
1ND 005 700-021	1.31	2BA 001 423-087	2.89	2BA 344 169-191	2.95	2BM 006 692-027	2.217
1ND 005 700-061	1.31	2BA 002 324-001	2.210	2BA 344 200-037	2.92, 2.313	2BM 008 355-001	2.216
1ND 005 700-841	1.31	2BA 002 324-011	2.210	2BA 344 200-241	2.94	2BM 008 355-007	2.216
1ND 010 953-101	1.32	2BA 002 324-021	2.210	2BA 344 200-247	2.94	2BM 008 355-017	2.216
1ND 010 953-111	1.32	2BA 002 652-101	2.209	2BA 344 200-341	2.94, 2.314	2BM 008 771-001	2.215
1ND 010 953-811	1.32	2BA 002 652-107	2.209	2BA 344 200-347	2.94	2BM 008 771-007	2.215
1ND 136 933-011	1.31	2BA 002 652-111	2.209	2BA 357 025-011	2.348	2BM 009 320-807	2.214
1ND 187 888-101	1.32	2BA 002 652-117	2.209	2BA 357 026-021	2.354	2BM 011 788-001	2.216
1NE...		2BA 002 652-121	2.209	2BA 357 027-021	2.355	2BM 011 788-007	2.216
1NE 002 537-201	1.32	2BA 002 652-127	2.209	2BA 357 028-021	2.356	2BM 011 788-011	2.216
1NE 006 300-011	1.33	2BA 002 939-251	2.211	2BA 357 029-031	2.349	2BM 011 788-021	2.216
1NE 006 300-051	1.33	2BA 003 014-011	2.119	2BA 357 029-131	2.349	2BM 011 788-027	2.216
1NE 006 300-101	1.33	2BA 003 014-111	2.119	2BA 959 011-301	2.90, 2.309	2BM 011 788-031	2.216
1NE 008 773-031	1.34	2BA 003 022-001	2.208	2BA 959 011-307	2.90, 2.309	2BM 011 788-041	2.216
1NE 138 555-011	1.33	2BA 003 022-021	2.208	2BA 959 822-601	2.103, 2.306	2BM 011 788-047	2.216
1NL...		2BA 003 022-037	2.208	2BA 959 932-011	2.212	2BM 011 788-051	2.216
1NL 007 186-021	1.37	2BA 003 236-021	2.126	2BA 959 932-051	2.212	2BM 011 788-057	2.216
1NL 007 186-047	1.37	2BA 003 236-027	2.126	2BA 964 169-011	2.100	2BM 011 788-061	2.216
1NL 007 186-061	1.37	2BA 003 236-321	2.127	2BA 964 169-017	2.100	2BM 011 788-071	2.216
1NL 007 834-017	1.54	2BA 003 236-541	2.127	2BA 964 169-041	2.101	2BM 011 788-077	2.216
1NL 007 834-057	1.54	2BA 003 7					



List of part numbers

Part number	Page	Part number	Page	Part number	Page	Part number	Page
2BN...		2JA...		2JA...		2KA...	
2BN 964 169-787	2.101	2JA 005 590-001	2.235	2JA 344 190-371	2.227	2KA 012 271-047	2.183, 2.326
2DA...		2JA 006 447-041	2.221	2JA 344 199-001	2.228	2KA 012 271-051	2.183, 2.326
2DA 001 240-341	2.104	2JA 006 447-087	2.221	2JA 344 199-011	2.228	2KA 012 271-057	2.183, 2.326
2DA 001 423-077	2.89	2JA 006 447-251	2.221	2JA 344 199-121	2.229	2KA 012 271-061	2.183, 2.326
2DA 003 014-031	2.118	2JA 006 487-261	2.221	2JA 344 199-201	2.229	2KA 012 271-067	2.183, 2.326
2DA 003 014-037	2.118	2JA 006 487-347	2.221	2JA 344 199-211	2.229	2KA 012 271-071	2.183, 2.326
2DA 003 236-031	2.126	2JA 007 372-001	2.243	2JA 344 199-221	2.229	2KA 012 271-077	2.183, 2.326
2DA 003 236-037	2.126	2JA 007 372-011	2.243	2JA 344 199-301	2.229	2KA 012 271-081	2.183, 2.326
2DA 003 236-331	2.127	2JA 007 372-041	2.243	2JA 344 199-311	2.229	2KA 012 271-087	2.183, 2.326
2DA 003 734-011	2.135	2JA 007 372-051	2.243	2JA 344 199-351	2.229	2KA 012 271-237	2.183, 2.326
2DA 005 200-321	2.128	2JA 007 373-001	2.242	2JA 344 199-371	2.229	2KA 012 271-277	2.183, 2.326
2DA 005 603-031	2.133	2JA 007 373-011	2.242	2JA 344 590-001	2.230	2KA 340 828-001	2.327
2DA 005 603-037	2.133	2JA 007 373-031	2.242	2JA 344 590-011	2.230	2KA 357 013-001	2.358
2DA 005 739-111	2.202	2JA 007 373-041	2.242	2JA 344 590-021	2.230	2KA 357 014-001	2.358
2DA 005 739-117	2.202	2JA 007 373-061	2.242	2JA 344 590-101	2.230	2KA 959 640-102	2.156
2DA 007 421-001	2.202	2JA 007 373-071	2.242	2JA 344 590-111	2.230	2KA 959 640-607	2.156, 2.325
2DA 007 421-007	2.202	2JA 007 373-107	2.242	2JA 344 590-121	2.230	2KA 959 640-661	2.325
2DA 007 421-017	2.202	2JA 007 373-117	2.242	2JA 344 599-001	2.231	2KA 997 011-001	2.183
2DA 007 421-027	2.202	2JA 007 373-127	2.242	2JA 344 599-011	2.231	2KA 997 011-011	2.183
2DA 007 428-001	2.202	2JA 007 373-137	2.242	2JA 344 599-021	2.231	2KA 997 011-021	2.183
2DA 007 428-007	2.202	2JA 007 373-151	2.241	2JA 344 599-101	2.231	2KA 997 122-001	2.181
2DA 007 541-001	2.202	2JA 007 373-157	2.241	2JA 344 599-121	2.231	2KA 998 523-001	2.185
2DA 007 858-037	2.203	2JA 007 373-161	2.241	2JA 344 599-201	2.231	2KA 998 523-007	2.185
2DA 008 136-007	2.204	2JA 007 373-177	2.241	2JA 344 599-211	2.231	2NE...	
2DA 008 136-017	2.204	2JA 007 373-187	2.241	2JA 344 599-221	2.231	2NE 001 423-011	2.89, 2.307
2DA 008 136-027	2.204	2JA 007 373-197	2.241	2JA 344 599-301	2.231	2NE 002 985-001	2.193
2DA 008 136-031	2.204	2JA 007 373-197	2.241	2JA 344 599-311	2.231	2NE 003 030-151	2.193
2DA 008 221-167	2.77	2JA 007 373-301	2.241	2JA 344 599-321	2.231	2NE 003 030-167	2.193
2DA 008 805-011	2.132	2JA 007 373-307	2.241	2JA 344 599-351	2.231	2NE 003 236-001	2.126
2DA 008 805-017	2.132	2JA 007 373-311	2.241	2JA 344 599-361	2.231	2NE 003 236-008	2.126
2DA 009 001-051	2.83	2JA 007 373-317	2.241	2JA 344 599-371	2.231	2NE 003 236-301	2.127
2DA 009 001-057	2.83	2JA 007 373-321	2.241	2JA 959 037-511	2.66	2NE 003 315-011	2.194
2DA 009 001-147	2.83	2JA 007 373-327	2.241	2JA 959 073-001	2.220	2NE 003 734-091	2.135
2DA 011 172-061	2.75	2JA 007 373-337	2.241	2JA 959 073-201	2.220	2NE 004 432-011	2.130
2DA 011 172-067	2.75	2JA 008 405-081	2.234	2JA 959 599-002	2.247	2NE 005 603-071	2.133
2DA 011 172-461	2.75	2JA 008 615-001	2.234	2JA 959 599-102	2.247	2NE 005 603-077	2.133
2DA 011 172-467	2.75	2JA 009 037-017	2.221	2JA 959 700-102	2.236	2NE 006 609-001	2.195
2DA 012 596-007	2.206	2JA 009 037-027	2.221	2JA 959 820-501	2.103	2NE 006 609-007	2.195
2DA 012 596-017	2.206	2JA 009 208-001	2.234	2JA 959 950-017	2.103	2NE 006 609-011	2.195
2DA 012 596-027	2.206	2JA 009 208-011	2.234	2JA 959 950-031	2.103	2NE 006 609-017	2.195
2DA 012 596-037	2.206	2JA 009 294-001	2.233	2JA 959 950-041	2.103	2NE 006 609-187	2.195
2DA 013 236-031	2.121	2JA 009 294-021	2.233	2JA 964 916-001	2.222	2NE 006 609-197	2.195
2DA 013 236-151	2.123	2JA 010 838-017	2.237	2JA 964 916-011	2.222	2NE 008 221-031	2.77
2DA 013 236-231	2.121	2JA 012 557-001	2.238	2JA 980 596-002	2.248	2NE 008 221-037	2.77
2DA 013 236-351	2.123	2JA 012 557-007	2.238	2JA 980 596-102	2.248	2NE 008 221-137	2.77
2DA 343 106-001	2.205	2JA 012 557-011	2.238	2JA 980 879-011	2.236	2NE 008 805-031	2.132
2DA 343 106-007	2.205	2JA 012 557-017	2.238	2JA 980 879-111	2.236	2NE 008 805-037	2.132
2DA 343 106-011	2.205	2JA 340 111-001	2.240	2JA 980 879-201	2.236	2NE 009 001-021	2.83
2DA 343 106-017	2.205	2JA 343 570-001	2.233	2JA 980 879-301	2.236	2NE 009 001-027	2.83
2DA 343 106-021	2.205	2JA 343 570-011	2.233	2JA 986 038-001	2.220	2NE 009 001-127	2.83
2DA 343 106-027	2.205	2JA 343 570-041	2.233	2JA 987 027-051	2.139, 2.236	2NE 011 172-081	2.75
2DA 343 106-031	2.205	2JA 343 570-051	2.233	2JA 988 560-017	2.232	2NE 011 172-087	2.75
2DA 343 106-037	2.205	2JA 343 570-061	2.233	2JA 988 560-057	2.232	2NE 011 172-481	2.75
2DA 343 106-047	2.205	2JA 343 570-101	2.233	2JA 988 569-017	2.240	2NE 011 172-487	2.75
2DA 343 106-047	2.205	2JA 343 570-117	2.233	2JB...		2NE 013 236-001	2.122, 2.124
2DA 343 106-201	2.205	2JA 343 570-141	2.233	2JB 343 227-041	2.234	2NE 013 236-201	2.122, 2.124
2DA 343 106-207	2.205	2JA 343 570-157	2.233	2JB 996 012-121	2.120	2NE 302 252-037	2.88
2DA 343 106-211	2.205	2JA 343 570-267	2.233	2KA...		2NE 343 130-031	2.111
2DA 343 106-217	2.205	2JA 343 606-001	2.235	2KA 001 378-001	2.180	2NE 343 130-037	2.111
2DA 343 106-221	2.205	2JA 343 606-007	2.235	2KA 001 378-041	2.180	2NE 343 130-177	2.108
2DA 343 106-227	2.205	2JA 343 606-011	2.235	2KA 001 378-127	2.180	2NE 343 130-277	2.108
2DA 343 106-231	2.205	2JA 343 606-017	2.235	2KA 001 378-207	2.180	2NE 344 169-067	2.100
2DA 343 800-001	2.204	2JA 343 606-201	2.235	2KA 001 386-231	2.186	2NE 344 169-117	2.100
2DA 343 800-007	2.204	2JA 343 606-217	2.235	2KA 001 386-281	2.186	2NE 344 200-061	2.92, 2.314
2DA 343 800-027	2.204	2JA 343 660-021	2.235	2KA 001 386-301	2.186	2NE 344 200-091	2.92, 2.314
2DA 343 800-047	2.204	2JA 343 660-101	2.235	2KA 001 386-497	2.186	2NE 344 200-097	2.92
2DA 343 800-057	2.204	2JA 343 660-107	2.235	2KA 001 389-101	2.184	2NE 344 610-007	2.196
2DA 343 800-077	2.204	2JA 343 660-117	2.235	2KA 001 389-107	2.184	2NE 344 610-027	2.196
2DA 344 130-607	2.108	2JA 343 660-407	2.235	2KA 001 610-001	2.184	2NE 344 610-037	2.196
2DA 344 130-617	2.108	2JA 343 680-067	2.222	2KA 001 622-001	2.185	2NE 357 026-031	2.354
2DA 357 015-001	2.362	2JA 343 680-127	2.222	2KA 003 168-021	2.184	2NE 357 027-031	2.355
2DA 357 015-101	2.362	2JA 343 680-177	2.222	2KA 003 389-001	2.159	2NE 357 028-031	2.356
2DA 959 071-037	2.203	2JA 343 700-051	2.223	2KA 003 389-011	2.159	2NE 357 029-041	2.350
2DA 959 071-237	2.203	2JA 343 700-167	2.223	2KA 003 389-061	2.159, 2.327	2NE 357 029-141	2.350
2DA 959 071-537	2.203	2JA 343 700-221	2.223	2KA 003 389-062	2.159	2NE 959 011-501	2.91, 2.310
2DA 959 071-737	2.203	2JA 343 700-251	2.223	2KA 003 389-068	2.159	2NE 959 011-507	2.91, 2.310
2DA 959 071-757	2.203	2JA 343 700-271	2.223	2KA 003 389-081	2.159	2NE 959 011-527	2.91
2DA 959 071-787	2.203	2JA 343 720-011	2.245	2KA 003 389-211	2.159	2NE 959 821-201	2.103, 2.306
2DA 959 580-151	2.203	2JA 343 720-021	2.245	2KA 003 389-217	2.159	2NE 964 169-021	2.100
2DA 959 580-551	2.203	2JA 343 720-071	2.245	2KA 003 389-398	2.159	2NE 964 169-027	2.100
2DA 964 169-001	2.100	2JA 343 720-081	2.245	2KA 003 738-057	2.180	2NE 964 169-227	2.100
2DA 964 169-007	2.100	2JA 343 720-111	2.245	2KA 004 331-061	2.180	2NE 964 169-341	2.96
2DA 965 039-091	2.86	2JA 343 720-121	2.245	2KA 004 331-067	2.180	2NE 964 169-521	2.97
2DA 965 039-317	2.86	2JA 343 720-157	2.245	2KA 004 331-107	2.180	2NE 964 169-527	2.97
2DA 980 887-311	2.140	2JA 343 720-191	2.245	2KA 005 525-001	2.184	2NE 965 039-111	2.86
2DA 980 887-411	2.140	2JA 343 720-511	2.245	2KA 005 049-008	2.180	2NE 965 039-117	2.86
2DA 996 012-041	2.120	2JA 343 720-521	2.245	2KA 005 049-011	2.180	2NE 965 039-327	2.86
2DA 997 027-021	2.139	2JA 343 720-531	2.245	2KA 005 049-017	2.180	2NE 980 889-501	2.141
2DB...		2JA 343 720-611	2.245	2KA 006 896-001	2.184	2NE 980 889-601	2.141
2DB 004 431-061	2.129	2JA 343 720-621	2.245	2KA 006 896-007	2.184	2NE 996 012-021	2.120
2JA...		2JA 343 720-631	2.245	2KA 007 929-001	2.185	2NR...	
2JA 001 330-001	2.237	2JA 343 790-107	2.226	2KA 007 929-007	2.185	2NR 344 169-441	2.96, 2.315
2JA 001 330-007	2.237	2JA 34					

List of part numbers



Part number	Page	Part number	Page	Part number	Page	Part number	Page
2PF...		2PG...		2PS...		2RL...	
2PF 003 389-037	2.160	2PG 964 295-111	2.154	2PS 345 600-057	2.146	2RL 006 846-001	3.04
2PF 003 389-041	2.160	2PG 964 295-117	2.154	2PS 345 600-061	2.145	2RL 006 846-011	3.04
2PF 003 563-151	2.169	2PG 964 295-121	2.154	2PS 345 600-067	2.145	2RL 006 846-101	3.04
2PF 003 563-177	2.169	2PG 964 295-127	2.154	2PS 345 600-071	2.145, 2.270	2RL 006 846-111	3.04
2PF 003 563-187	2.169	2PG 964 295-367	2.154	2PS 345 600-077	2.145	2RL 007 017-041	3.18
2PF 003 734-031	2.136			2PS 345 600-091	2.146	2RL 007 017-051	3.18
2PF 004 081-001	2.117	2PS...		2PS 345 600-101	2.146	2RL 007 017-061	3.18
2PF 004 081-007	2.117	2PS 002 727-001	2.144	2PS 345 600-111	2.146	2RL 007 017-071	3.18
2PF 004 081-017	2.117	2PS 003 057-051	2.116	2PS 345 600-137	2.145	2RL 007 337-001	3.04
2PF 006 679-007	2.166	2PS 003 057-057	2.116	2PS 345 600-147	2.145	2RL 007 337-011	3.04
2PF 006 717-011	2.138	2PS 003 748-121	2.142, 2.269	2PS 345 600-157	2.145	2RL 007 337-021	3.05
2PF 007 205-007	2.169	2PS 003 748-127	2.142	2PS 345 600-167	2.145	2RL 007 337-031	3.05
2PF 007 205-017	2.169	2PS 003 748-161	2.142, 2.269	2PS 345 600-177	2.145	2RL 007 337-041	3.04
2PF 008 221-011	2.78	2PS 003 748-167	2.142	2PS 345 600-197	2.145	2RL 007 337-057	3.05
2PF 008 221-017	2.78	2PS 004 361-001	2.144	2PS 357 008-001	2.351	2RL 007 337-101	3.04
2PF 008 221-177	2.78	2PS 004 361-007	2.144	2PS 357 008-011	2.351	2RL 007 337-111	3.04
2PF 008 405-051	2.74	2PS 006 717-031	2.138	2PS 357 009-001	2.352	2RL 007 337-121	3.05
2PF 008 405-057	2.74	2PS 006 717-032	2.138	2PS 357 009-101	2.352	2RL 007 550-001	3.07
2PF 008 405-061	2.74, 2.234	2PS 006 717-037	2.138	2PS 357 010-001	2.352	2RL 007 550-011	3.07
2PF 008 405-067	2.74	2PS 006 717-051	2.138	2PS 357 010-101	2.352	2RL 007 550-021	3.07
2PF 008 405-127	2.74	2PS 006 717-057	2.138	2PS 357 011-001	2.357	2RL 007 551-001	3.08
2PF 009 001-081	2.83	2PS 006 717-061	2.138	2PS 357 012-001	2.353	2RL 007 551-011	3.08
2PF 009 001-177	2.83	2PS 006 717-067	2.138	2PS 959 788-002	2.156	2RL 007 551-021	3.08
2PF 009 001-421	2.81	2PS 006 717-071	2.138	2PS 962 964-012	2.137	2RL 007 552-001	3.08
2PF 009 001-521	2.81	2PS 006 717-077	2.138	2PS 962 964-018	2.137	2RL 007 552-011	3.08
2PF 009 226-097	2.158	2PS 007 943-011	2.161	2PS 962 964-031	2.137	2RL 007 552-021	3.08
2PF 009 514-001	2.165, 2.264	2PS 007 943-017	2.161	2PS 962 964-037	2.137	2RL 007 553-001	3.09
2PF 009 514-011	2.165, 2.264	2PS 007 943-021	2.161	2PS 963 959-001	2.143, 2.270	2RL 007 553-011	3.09
2PF 010 278-907	2.170	2PS 007 943-027	2.161	2PS 963 959-007	2.143	2RL 007 553-021	3.09
2PF 010 278-917	2.170	2PS 007 943-311	2.161	2PS 963 959-011	2.143, 2.270	2RL 007 900-001	3.57
2PF 011 172-111	2.76	2PS 007 943-317	2.161	2PS 963 959-017	2.143	2RL 007 900-121	3.59
2PF 011 172-117	2.76	2PS 007 943-321	2.161	2PS 964 295-001	2.153	2RL 007 900-151	3.57
2PF 011 172-127	2.76	2PS 007 972-011	2.161	2PS 964 295-007	2.153	2RL 007 900-171	3.59
2PF 011 172-157	2.76	2PS 007 972-017	2.161	2PS 964 295-051	2.153	2RL 007 900-191	3.57
2PF 011 172-517	2.76	2PS 008 138-001	2.161	2PS 964 295-057	2.153	2RL 007 900-201	3.57
2PF 340 000-111	2.147	2PS 008 138-101	2.161	2PS 964 295-061	2.153	2RL 007 900-211	3.57
2PF 340 825-001	2.263	2PS 008 138-111	2.161	2PS 964 295-067	2.153	2RL 007 900-221	3.59
2PF 340 825-057	2.263	2PS 008 138-801	2.161	2PS 964 295-071	2.153	2RL 007 900-241	3.59
2PF 959 570-202	2.167, 2.263	2PS 008 138-811	2.161	2PS 964 295-077	2.153	2RL 007 900-251	3.57
2PF 959 570-207	2.167	2PS 008 138-821	2.161	2PS 964 295-081	2.153	2RL 007 900-261	3.57
2PF 959 570-212	2.167, 2.263	2PS 008 382-001	2.164	2PS 964 295-347	2.153	2RL 007 900-291	3.57
2PF 959 570-217	2.167	2PS 008 382-007	2.164	2PS 964 295-357	2.153	2RL 007 900-501	3.56
2PF 959 590-202	2.155, 2.263	2PS 008 382-801	2.164			2RL 007 900-511	3.56
2PF 959 590-207	2.155	2PS 008 382-811	2.164	2PT...		2RL 007 900-521	3.56
2PF 959 590-212	2.155, 2.263	2PS 008 616-001	2.163, 2.266	2PT 008 362-801	2.171	2RL 007 900-601	3.57
2PF 959 590-217	2.155	2PS 008 616-011	2.163, 2.266	2PT 008 935-001	2.171	2RL 007 900-611	3.57
2PF 959 590-218	2.155	2PS 008 616-017	2.163, 2.266	2PT 008 935-011	2.171	2RL 007 900-631	3.59
2PF 959 590-237	2.155	2PS 008 643-007	2.162, 2.267	2PT 008 935-801	2.171	2RL 007 900-681	3.59
2PF 959 590-247	2.155	2PS 008 643-011	2.162, 2.267	2PT 009 496-007	2.179	2RL 007 900-701	3.58
2PF 959 590-257	2.155	2PS 008 643-017	2.162, 2.267	2PT 009 496-801	2.179	2RL 008 060-001	3.11
2PF 959 855-201	2.157	2PS 008 643-021	2.162, 2.267	2PT 009 598-111	2.175	2RL 008 060-011	3.11
2PF 959 855-207	2.157	2PS 008 643-027	2.162, 2.267	2PT 009 598-121	2.175	2RL 008 060-101	3.11
2PF 959 855-241	2.157	2PS 008 643-031	2.162, 2.267	2PT 009 598-131	2.175	2RL 008 060-111	3.11
2PF 959 855-247	2.157	2PS 008 643-037	2.162, 2.267	2PT 009 598-141	2.175	2RL 008 061-001	3.10
2PF 959 855-251	2.157	2PS 008 643-331	2.162, 2.267	2PT 009 598-811	2.175	2RL 008 061-011	3.10
2PF 959 855-257	2.157	2PS 008 645-001	2.150, 2.268	2PT 010 043-011	2.176	2RL 008 061-101	3.10
2PF 961 167-021	2.165	2PS 008 645-007	2.150	2PT 010 043-021	2.176	2RL 008 061-111	3.10
2PF 962 964-061	2.137	2PS 008 645-011	2.150	2PT 010 043-031	2.176	2RL 008 062-001	3.10
2PF 962 964-071	2.137	2PS 008 645-017	2.150	2PT 010 043-041	2.176	2RL 008 062-011	3.10
2PF 964 295-021	2.154	2PS 008 645-187	2.150	2PT 010 043-801	2.176	2RL 008 062-101	3.10
2PF 964 295-027	2.154	2PS 008 645-187	2.150	2PT 010 047-201	2.171	2RL 008 062-111	3.10
2PF 964 295-257	2.154	2PS 008 645-301	2.268	2PT 010 047-821	2.171	2RL 008 063-001	3.11
2PF 965 039-017	2.86	2PS 008 645-311	2.268	2PT 010 102-111	2.218	2RL 008 063-011	3.11
2PF 965 039-151	2.86	2PS 008 645-361	2.268	2PT 010 458-701	2.172	2RL 008 063-101	3.11
2PF 996 012-051	2.120	2PS 008 645-497	2.150	2PT 010 458-711	2.172	2RL 008 063-111	3.11
2PF 996 112-031	2.170	2PS 008 645-507	2.150	2PT 010 458-721	2.172	2RL 008 064-001	3.12
2PF 997 022-011	2.166	2PS 008 645-601	2.150	2PT 010 458-731	2.172	2RL 008 064-101	3.12
2PF 997 023-011	2.166	2PS 008 645-607	2.150	2PT 010 458-741	2.173	2RL 008 065-001	3.13
2PF 997 027-011	2.139	2PS 008 645-611	2.150, 2.268	2PT 010 458-751	2.173	2RL 008 065-011	3.13
		2PS 008 645-621	2.150, 2.268	2PT 010 458-761	2.173	2RL 008 065-101	3.13
		2PS 008 645-717	2.150, 2.268	2PT 010 458-771	2.173	2RL 008 065-107	3.13
2PG...		2PS 008 645-787	2.150, 2.268	2PT 177 696-701	2.172	2RL 008 065-111	3.13
2PG 002 727-021	2.144	2PS 008 645-797	2.150, 2.268	2PT 177 696-711	2.172	2RL 008 181-001	3.16
2PG 003 057-011	2.116	2PS 008 645-891	2.150, 2.268	2PT 177 696-721	2.172	2RL 008 181-011	3.16
2PG 003 057-061	2.116	2PS 008 645-981	2.150	2PT 177 696-731	2.172	2RL 008 181-101	3.16
2PG 003 057-067	2.116	2PS 008 645-991	2.150, 2.268	2PT 177 696-741	2.173	2RL 008 181-111	3.16
2PG 003 748-151	2.142, 2.264	2PS 009 226-007	2.158	2PT 177 696-751	2.173	2RL 008 182-001	3.17
2PG 004 361-011	2.144	2PS 009 226-017	2.158	2PT 177 696-761	2.173	2RL 008 182-011	3.17
2PG 004 361-017	2.144	2PS 009 226-021	2.158	2PT 177 696-771	2.173	2RL 008 182-101	3.17
2PG 006 717-021	2.138	2PS 009 226-027	2.158	2PT 965 039-171	2.87	2RL 008 182-111	3.17
2PG 006 717-027	2.138	2PS 009 226-031	2.158	2PT 965 039-177	2.87	2RL 008 183-001	3.17
2PG 008 434-001	2.169	2PS 009 226-037	2.158	2PT 980 680-001	2.176	2RL 008 183-011	3.17
2PG 008 645-321	2.262	2PS 009 226-067	2.158	2PT 980 680-101	2.177	2RL 008 183-101	3.17
2PG 008 645-331	2.262	2PS 009 226-077	2.158	2PT 980 680-501	2.176	2RL 008 183-111	3.17
2PG 008 645-541	2.149, 2.262	2PS 009 226-087	2.158	2PT 980 680-601	2.176	2RL 008 364-021	3.09
2PG 008 645-561	2.149	2PS 009 226-147	2.158	2PT 980 680-801	2.176	2RL 008 366-021	3.16
2PG 008 645-567	2.149	2PS 009 226-157	2.158	2PT 980 680-821	2.177	2RL 008 366-031	3.16
2PG 008 645-631	2.149, 2.262	2PS 009 226-167	2.158	2PT 980 680-851	2.176	2RL 008 965-001	3.05
2PG 008 645-641	2.149, 2.262	2PS 011 422-341	2.150	2PT 980 680-861	2.177	2RL 008 965-011	3.05
2PG 008 645-831	2.149, 2.262	2PS 011 422-347	2.150	2PT 980 690-601	2.175	2RL 008 965-021	3.05
2PG 008 645-917	2.149	2PS 340 000-001	2.147	2PT 980 691-601	2.175	2RL 008 965-031	3.05
2PG 008 645-961	2.149, 2.262	2PS 340 000-011	2.147, 2.270	2PT 980 789-051	2.174	2RL 008 965-041	3.05
2PG 008 645-967	2.149	2PS 3					



List of part numbers

Part number	Page	Part number	Page	Part number	Page	Part number	Page
2RL...		2RL...		2SA...		2SD...	
2RL 010 710-171	3.40	2RL 010 713-021	3.42	2SA 008 805-001	2.132	2SD 001 685-211	2.62, 2.308
2RL 010 710-181	3.41	2RL 010 713-031	3.42	2SA 008 805-007	2.132	2SD 001 685-218	2.62
2RL 010 710-191	3.41	2RL 010 713-041	3.42	2SA 009 001-137	2.83	2SD 001 685-231	2.62, 2.308
2RL 010 710-211	3.37	2RL 010 713-051	3.42	2SA 011 172-041	2.75	2SD 001 685-232	2.62
2RL 010 710-221	3.38	2RL 010 713-061	3.42	2SA 011 172-047	2.75	2SD 001 685-277	2.62
2RL 010 710-231	3.40	2RL 010 713-071	3.42	2SA 011 172-441	2.75	2SD 001 685-307	2.61
2RL 010 710-241	3.40	2RL 010 713-081	3.42	2SA 011 172-447	2.75	2SD 001 685-317	2.62
2RL 010 710-251	3.41	2RL 010 713-091	3.39	2SA 013 236-041	2.121	2SD 001 685-347	2.61, 2.308
2RL 010 710-261	3.40-3.41	2RL 010 713-101	3.42	2SA 013 236-161	2.123	2SD 001 685-627	2.62
2RL 010 710-281	3.41	2RL 010 713-111	3.39	2RL 010 713-111	2.121	2SD 001 686-101	2.63
2RL 010 710-311	3.40	2RL 010 713-121	3.42	2SA 013 236-241	2.121	2SD 001 688-141	2.24
2RL 010 710-391	3.40	2RL 010 713-131	3.51	2SA 013 236-361	2.123	2SD 001 688-171	2.24
2RL 010 710-471	3.37	2RL 010 713-141	3.50	2SA 961 167-011	2.165	2SD 001 693-011	2.45
2RL 010 710-561	3.41	2RL 010 713-151	3.42	2SA 962 964-091	2.137	2SD 001 699-061	2.28
2RL 010 710-631	3.41	2RL 010 713-161	3.39	2SA 964 169-091	2.98	2SD 001 699-511	2.28
2RL 010 710-701	3.41	2RL 010 713-171	3.39	2SA 964 169-097	2.98	2SD 002 514-161	2.55
2RL 010 710-741	3.38	2RL 010 713-181	3.50	2SA 965 039-001	2.86	2SD 002 582-011	2.67
2RL 010 710-791	3.38	2RL 010 713-191	3.50	2SA 965 039-081	2.86	2SD 002 582-017	2.67
2RL 010 710-841	3.38	2RL 010 713-201	3.49	2SA 965 039-087	2.86	2SD 002 582-021	2.67
2RL 010 710-851	3.41	2RL 010 713-211	3.39	2SA 965 039-307	2.86	2SD 002 582-027	2.67
2RL 010 710-871	3.41	2RL 010 713-221	3.51	2SA 996 012-091	2.120	2SD 002 776-231	2.72
2RL 010 710-881	3.40	2RL 010 713-231	3.39	2SA 997 022-001	2.166	2SD 002 776-237	2.72
2RL 010 710-891	3.40	2RL 010 713-241	3.51	2SA 997 023-001	2.166	2SD 002 776-241	2.72
2RL 010 710-901	3.37	2RL 010 713-251	3.42	2SA 997 027-001	2.139	2SD 002 776-247	2.72
2RL 010 710-911	3.40	2RL 010 713-261	3.49	2SB...		2SD 003 167-011	2.36, 2.285
2RL 010 710-921	3.38	2RL 010 713-271	3.51	2SB 001 240-311	2.104	2SD 003 167-021	2.36, 2.285
2RL 010 710-941	3.41	2RL 010 713-281	3.51	2SB 001 259-261	2.113	2SD 003 167-521	2.36
2RL 010 710-961	3.43	2RL 010 713-291	3.51	2SB 001 301-021	2.63	2SD 003 167-531	2.36
2RL 010 710-971	3.43	2RL 010 713-301	3.50	2SB 001 301-021	2.63	2SD 003 167-541	2.36
2RL 010 710-981	3.43	2RL 010 713-311	3.51	2SB 001 423-097	2.89	2SD 003 182-051	2.71
2RL 010 710-991	3.43	2RL 010 713-341	3.42	2SB 001 673-002	2.63	2SD 003 182-057	2.71
2RL 010 711-001	3.44	2RL 010 713-351	3.42	2SB 003 014-151	2.118	2SD 003 182-061	2.71
2RL 010 711-011	3.44	2RL 010 713-361	3.50	2SB 003 018-031	2.73	2SD 003 182-067	2.71
2RL 010 711-021	3.44	2RL 010 713-371	3.49	2SB 004 460-061	2.37	2SD 003 184-031	2.68
2RL 010 711-031	3.45	2RL 010 713-381	3.50	2SB 005 603-137	2.133	2SD 003 184-037	2.68
2RL 010 711-041	3.45	2RL 010 713-391	3.53	2SB 008 405-091	2.74	2SD 003 184-041	2.68
2RL 010 711-051	3.45	2RL 010 713-451	3.50	2SB 008 405-101	2.74	2SD 003 184-047	2.68
2RL 010 711-061	3.45	2RL 010 713-461	3.50	2SB 008 805-021	2.132	2SD 003 409-327	2.45
2RL 010 711-071	3.45	2RL 010 713-471	3.50	2SB 008 805-027	2.132	2SD 004 431-011	2.129
2RL 010 711-081	3.45	2RL 010 713-481	3.50	2SB 008 805-201	2.131	2SD 004 460-001	2.37
2RL 010 711-091	3.46	2RL 010 713-491	3.50	2SB 008 805-237	2.132	2SD 004 460-011	2.37
2RL 010 711-101	3.46	2RL 010 713-501	3.49	2SB 008 982-001	2.130	2SD 004 460-017	2.37
2RL 010 711-111	3.46	2RL 010 713-511	3.39	2SB 008 982-007	2.130	2SD 004 623-028	2.54
2RL 010 711-121	3.46	2RL 010 713-521	3.50	2SB 008 982-367	2.130	2SD 006 040-031	2.33
2RL 010 711-131	3.46	2RL 010 713-531	3.52	2SB 009 001-061	2.83	2SD 006 040-037	2.33
2RL 010 711-141	3.47	2RL 010 713-541	3.50	2SB 009 001-067	2.83	2SD 006 040-041	2.33
2RL 010 711-151	3.47	2RL 010 713-551	3.51	2SB 009 001-157	2.83	2SD 006 040-131	2.34
2RL 010 711-161	3.47	2RL 010 713-561	3.50	2SB 009 001-401	2.81	2SD 006 040-137	2.34
2RL 010 711-171	3.47	2RL 010 713-571	3.50	2SB 009 001-501	2.81	2SD 006 040-141	2.34
2RL 010 711-181	3.47	2RL 010 713-581	3.51	2SB 009 362-011	2.79	2SD 006 040-147	2.34
2RL 010 711-191	3.47	2RL 010 713-591	3.49	2SB 009 362-021	2.79	2SD 006 040-161	2.33
2RL 010 711-201	3.48	2RL 010 743-001	3.35	2SB 009 362-041	2.79	2SD 006 040-167	2.33
2RL 010 711-211	3.48	2RL 010 743-011	3.35	2SB 009 362-067	2.79	2SD 010 546-127	2.82
2RL 010 711-221	3.48	2RL 010 743-021	3.35	2SB 009 362-301	2.80	2SD 010 546-137	2.82
2RL 010 711-231	3.40	2RL 010 743-031	3.35	2SB 009 362-311	2.80	2SD 340 685-051	2.61, 2.308
2RL 010 711-281	3.47	2RL 010 743-041	3.35	2SB 009 362-321	2.80	2SD 343 130-011	2.111
2RL 010 711-291	3.38	2RL 010 743-051	3.35	2SB 009 362-331	2.80	2SD 343 130-017	2.111
2RL 010 711-301	3.46	2RL 010 743-061	3.35	2SB 013 236-071	2.121	2SD 343 130-071	2.111
2RL 010 711-321	3.38	2RL 010 743-071	3.35	2SB 013 236-171	2.123	2SD 343 130-137	2.111
2RL 010 711-331	3.43	2RL 010 743-081	3.35	2SB 013 236-271	2.121	2SD 343 130-147	2.111
2RL 010 711-341	3.48	2RL 010 743-091	3.35	2SB 013 236-371	2.123	2SD 343 130-157	2.111
2RL 010 711-351	3.48	2RL 010 743-101	3.35	2SB 302 252-057	2.88	2SD 343 130-167	2.111
2RL 010 711-361	3.46	2RL 010 743-111	3.35	2SB 343 130-027	2.111	2SD 343 130-227	2.108
2RL 010 711-371	3.40	2RL 010 743-121	3.35	2SB 343 130-757	2.111	2SD 343 130-337	2.107
2RL 010 711-381	3.44	2RL 010 743-131	3.35	2SB 343 130-767	2.111	2SD 343 130-377	2.107
2RL 010 711-391	3.44	2RL 010 743-141	3.35	2SB 343 390-091	2.106	2SD 343 130-397	2.108
2RL 010 711-411	3.44	2RL 010 743-151	3.35	2SB 343 400-317	2.108	2SD 343 130-737	2.108
2RL 010 711-421	3.52	2RL 010 979-001	3.19	2SB 343 400-327	2.108	2SD 343 130-747	2.108
2RL 010 711-431	3.52	2RL 010 979-011	3.19	2SB 344 169-017	2.97	2SD 343 130-797	2.110
2RL 010 711-511	3.44	2RL 010 979-021	3.19	2SB 344 200-027	2.92, 2.312	2SD 343 130-807	2.110
2RL 010 711-521	3.52	2RL 010 979-101	3.19	2SB 344 200-081	2.92, 2.312	2SD 343 390-011	2.106
2RL 010 711-531	3.40	2RL 010 979-111	3.19	2SB 344 200-221	2.94	2SD 343 390-401	2.105
2RL 010 711-541	3.48	2RL 010 979-121	3.19	2SB 344 200-227	2.94	2SD 343 390-407	2.105
2RL 010 711-561	3.40	2RL 011 484-001	3.20	2SB 344 200-231	2.94	2SD 343 390-417	2.105
2RL 010 711-571	3.52	2RL 011 484-011	3.20	2SB 344 200-237	2.94	2SD 343 390-707	2.105
2RL 010 711-581	3.46	2RL 011 484-021	3.20	2SB 344 200-321	2.94, 2.313	2SD 343 440-017	2.41
2RL 010 711-591	3.52	2RL 011 484-101	3.20	2SB 344 200-327	2.94	2SD 343 440-047	2.41
2RL 010 711-601	3.45	2RL 011 484-111	3.20	2SB 344 200-331	2.94, 2.313	2SD 343 440-057	2.41
2RL 010 711-611	3.46	2RL 011 484-121	3.20	2SB 344 200-337	2.94	2SD 343 910-001	2.52
2RL 010 711-621	3.46	2RL 863 106-001	3.54, 3.59	2SB 357 025-001	2.348	2SD 343 910-007	2.52
2RL 010 711-631	3.45	2RL 863 106-011	3.54, 3.59	2SB 357 026-011	2.354	2SD 343 910-017	2.52
2RL 010 711-641	3.44	2RL 863 123-001	3.54	2SB 357 027-011	2.355	2SD 343 910-027	2.52
2RL 010 711-651	3.44	2RL 863 123-011	3.54	2SB 357 028-011	2.356	2SD 343 910-057	2.52
2RL 010 711-661	3.37	2RL 863 132-021	3.54	2SB 357 029-011	2.349	2SD 344 100-001	2.60, 2.311
2RL 010 711-671	3.38	2RL 864 233-001	3.39, 3.63	2SB 357 029-111	2.349	2SD 344 100-101	2.60, 2.311
2RL 010 711-681	3.41	2RL 864 233-011	3.63	2SB 959 010-001	2.90, 2.309	2SD 344 169-037	2.98
2RL 010 711-691	3.38	2RL 864 233-101	3.37-3.38	2SB 959 010-301	2.90, 2.309	2SD 344 169-137	2.98
2RL 010 711-701	3.44	2RL 864 233-111	3.37-3.38	2SB 959 010-307	2.90, 2.309	2SD 344 169-147	2.98
2RL 010 711-711	3.50	2SA...		2SB 959 010-317	2.90	2SD 344 169-237	2.98
2RL 010 711-721	3.52	2SA 001 240-331	2.104	2SB 959 821-601	2.103, 2.306	2SD 344 169-247	2.98
2RL 010 711-731	3.46	2SA 001 259-751	2.113	2SB 964 169-287	2.99	2SD 344 200-001	2.91, 2.312
2RL 010 711-741	3.37	2SA 001 259-757	2.113	2SB 964 169-301	2.95	2SD 344 200-071	2.91, 2.312
2RL 010 711-751	3.45	2SA 001 634-121	2.166	2SB 964 169-307	2.95	2SD 344 200-077	2.91
2RL 010 711-761	3.38	2SA 001 638-021	2.168	2SB 964 169-531	2.97	2SD 344 200-20	

List of part numbers



Part number	Page	Part number	Page	Part number	Page	Part number	Page
2SD...		2TA...		2VB...		2VP...	
2SD 964 169-401	2.95	2TA 964 169-797	2.99	2VB 980 720-407	2.58, 2.305	2VP 012 381-081	2.14, 2.295
2SD 964 169-411	2.95	2TF...		2VB 980 720-501	2.58, 2.305	2VP 012 381-221	2.16, 2.297
2SD 964 169-421	2.95	2TF 001 259-761	2.113	2VB 980 720-507	2.58, 2.305	2VP 012 381-241	2.16, 2.297
2SD 980 602-211	2.65, 2.303	2TJ...		2VB 998 232-011	2.47	2VP 012 381-261	2.16
2SD 980 613-211	2.65, 2.303	2TJ 001 633-211	2.168	2VB 998 232-021	2.47	2VP 012 381-281	2.16
2SD 996 030-021	2.54	2TM...		2VB 998 232-101	2.49	2VP 012 381-321	2.15, 2.296
2SD 997 006-021	2.70	2TM 003 057-031	2.116	2VB 998 232-131	2.49	2VP 012 381-341	2.15, 2.296
2SD 997 006-031	2.70	2TM 003 748-011	2.142, 2.317	2VB 998 232-171	2.49	2VP 012 381-361	2.15, 2.296
2SD 997 131-051	2.69	2TM 004 361-021	2.144	2VB 998 232-201	2.49	2VP 012 381-381	2.15, 2.296
2SD 997 131-367	2.69	2TM 006 717-047	2.138	2VB 998 232-211	2.48	2VP 012 570-011	2.39
2SD 998 531-057	2.53	2TM 008 645-351	2.316	2VB 998 232-221	2.48	2VP 012 570-021	2.39
2SD 998 531-067	2.53	2TM 008 645-651	2.148, 2.316	2VB 998 232-231	2.50	2VP 012 570-031	2.39
2SE...		2TM 008 645-661	2.148, 2.316	2VB 998 232-241	2.50	2VP 012 570-041	2.39
2SE 001 306-051	2.53	2TM 008 645-921	2.148	2VB 998 232-537	2.47	2VP 012 570-051	2.39
2SE 001 679-051	2.63	2TM 008 645-931	2.148	2VB 998 232-557	2.48	2VP 012 570-061	2.39
2SE 001 680-291	2.28	2TM 008 645-937	2.148	2VD...		2VP 012 570-071	2.39
2SE 001 680-301	2.28	2TM 008 645-941	2.148, 2.316	2VD 003 567-371	2.21	2VP 012 570-081	2.39
2SE 001 685-201	2.62, 2.308	2TM 008 645-947	2.148	2VD 005 300-551	2.18, 2.293	2VP 012 570-111	2.38
2SE 001 685-221	2.62, 2.308	2TM 008 645-951	2.148, 2.316	2VD 005 300-581	2.18, 2.293	2VP 012 570-121	2.38
2SE 001 685-227	2.62	2TM 008 645-957	2.148	2VD 007 323-031	2.08	2VP 012 570-131	2.38
2SE 001 685-617	2.62	2TM 344 690-357	2.151	2VD 007 323-041	2.08	2VP 012 570-141	2.38
2SE 001 686-142	2.63	2TM 345 600-307	2.145	2VD 007 323-131	2.08	2VP 012 570-161	2.38
2SE 001 688-151	2.24	2TM 345 600-311	2.145	2VD 007 323-141	2.08	2VP 012 570-171	2.38
2SE 001 688-161	2.24	2TM 345 600-317	2.145, 2.317	2VD 007 500-091	2.17, 2.286	2VP 012 570-181	2.38
2SE 001 699-071	2.28	2TM 357 008-021	2.351	2VD 007 500-111	2.17, 2.286	2VP 340 400-121	2.298
2SE 002 514-171	2.55	2TM 357 009-111	2.352	2VD 007 500-201	2.17, 2.286	2VP 340 400-131	2.298
2SE 002 517-701	2.55	2TM 357 010-111	2.352	2VD 007 500-221	2.17, 2.286	2VP 340 400-141	2.298
2SE 002 578-707	2.55	2TM 357 011-011	2.352	2VD 007 500-411	2.17, 2.286	2VP 340 400-147	2.298
2SE 002 582-071	2.67	2TM 357 012-011	2.353	2VD 007 547-181	2.35	2VP 340 400-151	2.298
2SE 002 776-211	2.72	2TM 964 295-091	2.153	2VD 008 204-051	2.10, 2.290	2VP 340 400-157	2.298
2SE 002 776-217	2.72	2TM 964 295-097	2.153	2VD 008 204-071	2.10, 2.290	2VP 340 400-451	2.298
2SE 002 776-221	2.72	2TM 964 295-107	2.153	2VD 008 204-091	2.11, 2.291	2VP 340 400-471	2.298
2SE 003 167-031	2.36, 2.285	2VA...		2VD 008 204-111	2.11, 2.291	2VP 340 450-021	2.277
2SE 003 167-041	2.36, 2.285	2VA 004 887-031	2.19, 2.288	2VD 008 204-131	2.10, 2.290	2VP 340 450-031	2.277
2SE 003 182-011	2.71	2VA 006 040-071	2.32	2VD 008 204-141	2.10	2VP 340 450-141	2.277
2SE 003 182-017	2.71	2VA 006 040-077	2.32	2VD 008 204-171	2.10, 2.290	2VP 340 450-151	2.277
2SE 003 182-021	2.71	2VA 006 040-291	2.33	2VD 008 204-191	2.10, 2.290	2VP 340 450-441	2.276
2SE 003 182-027	2.71	2VA 006 356-101	2.52	2VD 008 204-211	2.09, 2.289	2VP 340 450-451	2.276
2SE 003 184-011	2.68	2VA 007 502-011	2.42	2VD 008 204-231	2.09, 2.289	2VP 340 450-501	2.276
2SE 003 184-017	2.68	2VA 007 502-021	2.42	2VD 008 204-251	2.09, 2.289	2VP 340 450-511	2.276
2SE 004 623-001	2.54, 2.56	2VA 007 502-061	2.42	2VD 008 205-011	2.12, 2.292	2VP 340 830-001	2.279
2SE 004 623-007	2.54	2VA 007 502-117	2.42	2VD 008 205-021	2.12, 2.292	2VP 340 830-011	2.279
2SE 006 040-011	2.33	2VA 007 502-117	2.42	2VD 008 205-041	2.12, 2.292	2VP 340 830-021	2.279
2SE 007 547-011	2.35	2VA 011 900-001	2.57	2VD 008 205-051	2.12, 2.292	2VP 340 830-031	2.279
2SE 007 547-017	2.35	2VA 011 900-011	2.57	2VD 008 789-011	2.20	2VP 340 830-101	2.280
2SE 007 547-021	2.35	2VA 011 900-021	2.57	2VD 011 511-031	2.13, 2.294	2VP 340 830-111	2.280
2SE 007 547-027	2.35	2VA 012 497-011	2.59	2VD 011 511-231	2.13, 2.294	2VP 340 831-001	2.278
2SE 007 547-041	2.35	2VA 012 497-061	2.59	2VD 012 381-011	2.14, 2.295	2VP 340 831-011	2.278
2SE 357 032-011	2.347	2VA 012 497-161	2.59	2VD 012 381-031	2.14, 2.295	2VP 340 888-001	2.12, 2.292
2SE 357 032-021	2.347	2VA 012 497-111	2.59	2VD 012 381-211	2.16, 2.297	2VP 340 888-007	2.12
2SE 996 030-011	2.54	2VA 012 497-151	2.59	2VD 012 381-251	2.16, 2.297	2VP 340 888-011	2.12, 2.292
2SE 997 006-011	2.70	2VA 012 497-161	2.59	2VD 012 381-261	2.297	2VP 340 888-017	2.279
2SE 997 008-001	2.55	2VA 012 497-171	2.59	2VD 012 381-281	2.297	2VP 340 930-001	2.279
2SE 997 008-001	2.24	2VA 012 497-181	2.59	2VD 012 381-281	2.297	2VP 340 930-011	2.279
2SE 997 111-011	2.53	2VA 012 497-187	2.44	2VD 012 381-311	2.15, 2.296	2VP 340 930-021	2.279
2SE 997 111-021	2.53	2VA 012 497-191	2.59	2VD 012 381-351	2.15, 2.296	2VP 340 930-021	2.279
2SE 998 530-061	2.56	2VA 012 497-201	2.59	2VP...		2VP 340 930-031	2.279
2SE 998 530-067	2.56	2VA 012 497-207	2.59	2VP 003 567-111	2.21, 2.287	2VP 340 930-101	2.280
2SK...		2VA 012 497-211	2.59	2VP 003 567-121	2.21, 2.287	2VP 340 930-111	2.280
2SK 003 567-321	2.22, 2.287	2VA 012 497-217	2.59	2VP 003 567-127	2.21	2VP 340 931-001	2.278
2SK 003 567-331	2.22, 2.287	2VA 012 497-251	2.59	2VP 006 040-011	2.32	2VP 340 931-011	2.278
2SK 003 567-651	2.22, 2.287	2VA 012 497-257	2.59	2VP 006 040-111	2.32	2VP 340 931-101	2.280
2SK 003 567-661	2.22, 2.287	2VA 012 497-259	2.59	2VP 006 040-121	2.32	2VP 340 931-111	2.281
2SK 004 460-031	2.37	2VA 012 497-261	2.59	2VP 006 040-127	2.32	2VP 340 932-001	2.281
2SK 004 460-037	2.37	2VA 012 497-267	2.59	2VP 006 040-131	2.32	2VP 340 932-011	2.281
2SK 004 460-041	2.37	2VA 012 497-269	2.59	2VP 006 040-301	2.33	2VP 340 934-101	2.281
2SK 004 460-047	2.37	2VA 012 497-271	2.59	2VP 006 040-307	2.33	2VP 340 934-111	2.281
2SK 004 460-041	2.37	2VA 012 497-277	2.59	2VP 006 040-351	2.33	2VP 340 940-101	2.283
2SK 005 883-011	2.18	2VA 012 497-281	2.59	2VP 006 040-357	2.33	2VP 340 940-111	2.283
2SK 005 883-021	2.18	2VA 012 497-287	2.59	2VP 006 040-397	2.32	2VP 340 942-001	2.282
2SK 340 101-001	2.285	2VA 012 497-289	2.59	2VP 006 040-407	2.32	2VP 340 942-011	2.282
2SK 340 101-011	2.285	2VA 012 497-291	2.59	2VP 006 040-437	2.32	2VP 340 942-101	2.283
2SK 340 101-021	2.285	2VA 012 497-297	2.59	2VP 006 040-447	2.32	2VP 340 942-111	2.283
2SK 340 101-031	2.285	2VA 012 497-301	2.59	2VP 006 040-477	2.32	2VP 340 950-011	2.284
2SK 343 440-027	2.41	2VA 012 497-307	2.59	2VP 006 040-487	2.32	2VP 340 950-021	2.284
2SK 343 440-037	2.41	2VA 012 497-311	2.59	2VP 007 323-011	2.08	2VP 340 950-031	2.284
2SK 343 440-067	2.41	2VA 012 497-317	2.59	2VP 007 323-021	2.08	2VP 340 950-041	2.284
2SK 980 602-501	2.64, 2.302	2VA 012 497-321	2.59	2VP 007 323-091	2.09	2VP 340 950-051	2.20, 2.284
2SK 980 603-503	2.64, 2.302	2VA 012 497-327	2.59	2VP 007 323-101	2.09	2VP 340 960-011	2.271
2SK 980 613-501	2.64, 2.302	2VA 012 497-331	2.59	2VP 007 323-111	2.09	2VP 340 960-111	2.271
2SK 980 615-001	2.64, 2.302	2VA 012 497-337	2.59	2VP 007 323-121	2.08	2VP 340 960-121	2.271
2SL...		2VA 012 497-341	2.59	2VP 007 500-421	2.17, 2.286	2VP 340 960-271	2.271
2SL 003 567-311	2.22, 2.287	2VA 012 497-347	2.59	2VP 007 500-521	2.17, 2.286	2VP 340 960-281	2.271
2SL 003 567-691	2.22	2VA 012 497-351	2.59	2VP 007 502-031	2.42	2VP 340 961-011	2.272
2SL 005 883-031	2.18	2VA 012 497-357	2.59	2VP 007 502-041	2.42	2VP 340 961-021	2.272
2SL 005 883-041	2.18	2VA 012 497-361	2.59	2VP 007 502-121	2.42	2VP 340 961-031	2.272
2SL 007 547-061	2.35	2VA 012 497-367	2.59	2VP 007 502-127	2.42	2VP 340 961-041	2.272
2SL 007 547-067	2.35	2VA 012 497-371	2.59	2VP 007 907-031	2.19	2VP 340 961-111	2.272-2.273
2ST...		2VA 012 497-377	2.59	2VP 007 907-037	2.19	2VP 340 961-121	2.272-2.273
2ST 001 259-321	2.113	2VA 012 497-381	2.59	2VP 007 907-041	2.19	2VP 340 961-131	2.274
2ST 001 673-011	2.63	2VA 012 497-387	2.59	2VP 007 907-047	2.19	2VP 340 961-141	2.274
2ST 003 014-141	2.118	2VA 012 497-391	2.59	2VP 008 204-041	2.10, 2.2		



List of part numbers

Part number	Page	Part number	Page	Part number	Page	Part number	Page
2VP...		2XD...		2XS...		2XW...	
2VP 343 520-057	2.40	2XD 011 557-001	3.22	2XS 011 744-161	2.281, 2.283, 2.318	2XW 003 146-001	2.253
2VP 343 520-061	2.40	2XD 011 557-011	3.22	2XS 011 744-171	2.281, 2.283, 2.318	2XW 007 146-001	2.252, 2.329
2VP 343 520-067	2.40	2XD 011 557-021	3.22	2XS 011 744-181	2.318	2XW 007 146-011	2.253, 2.330
2VP 343 590-017	2.44	2XD 011 557-031	3.22	2XS 011 744-191	2.318	2ZR...	
2VP 343 590-027	2.44	2XD 011 557-101	3.22	2XS 011 744-201	2.318	2ZR 001 193-011	2.201
2VP 343 590-057	2.45	2XD 011 557-111	3.22	2XS 011 744-211	2.318	2ZR 001 240-351	2.104
2VP 343 590-067	2.45	2XD 011 557-121	3.22	2XS 011 768-001	2.319	2ZR 001 240-377	2.104
2VP 343 640-021	2.31	2XD 011 557-131	3.22	2XS 011 768-011	2.319	2ZR 001 421-101	2.115
2VP 343 640-027	2.31	2XD 011 557-201	3.22	2XS 011 768-021	2.319	2ZR 001 423-001	2.89, 2.307
2VP 343 640-031	2.31	2XD 011 557-211	3.22	2XS 011 768-031	2.319	2ZR 002 694-001	2.201
2VP 343 640-041	2.30	2XD 011 557-221	3.22	2XS 011 768-061	2.319	2ZR 002 985-081	2.193
2VP 343 640-047	2.30	2XD 011 557-301	3.22	2XS 011 768-071	2.319	2ZR 002 985-261	2.193
2VP 343 640-051	2.30	2XD 011 557-311	3.22	2XS 011 768-087	2.319	2ZR 003 014-091	2.119
2VP 343 640-057	2.30	2XD 011 557-321	3.22	2XS 011 768-117	2.319	2ZR 003 030-171	2.193
2VP 343 640-081	2.30	2XD 011 557-501	3.22	2XS 011 769-011	2.320	2ZR 003 236-051	2.126, 2.239
2VP 343 640-087	2.30	2XD 012 160-801	3.31	2XS 011 769-021	2.320	2ZR 003 236-057	2.126
2VP 343 640-091	2.30	2XD 012 160-811	3.31	2XS 011 769-051	2.320	2ZR 003 236-311	2.127
2VP 343 640-097	2.30	2XD 012 160-821	3.31	2XS 011 769-061	2.320	2ZR 003 315-041	2.194
2VP 343 640-247	2.29	2XD 012 160-831	3.31	2XS 011 769-091	2.320	2ZR 003 734-041	2.135
2VP 343 640-267	2.29	2XD 012 160-841	3.31	2XS 011 769-101	2.320	2ZR 004 432-001	2.130
2VP 343 640-277	2.29	2XD 012 160-851	3.31	2XS 205 020-001	2.190	2ZR 004 542-001	2.200
2VP 345 900-011	2.27, 2.301	2XD 012 160-861	3.31	2XS 205 020-007	2.190	2ZR 005 200-301	2.128
2VP 345 900-021	2.27, 2.301	2XD 012 160-871	3.31	2XS 205 020-011	2.190	2ZR 005 603-061	2.133
2VP 345 900-091	2.27, 2.301	2XD 012 160-881	3.31	2XS 205 020-017	2.190	2ZR 005 603-067	2.133
2VP 345 900-101	2.27, 2.301	2XD 012 160-901	3.32	2XS 205 020-021	2.190	2ZR 005 700-191	2.200
2VP 345 900-131	2.27, 2.301	2XD 012 160-911	3.32	2XS 205 020-027	2.190	2ZR 005 860-151	2.200
2VP 345 900-141	2.27, 2.301	2XD 012 160-951	3.32	2XS 205 020-031	2.190	2ZR 006 609-081	2.195
2VP 345 900-201	2.25, 2.299	2XD 012 160-961	3.32	2XS 205 020-037	2.190	2ZR 006 609-087	2.195
2VP 345 900-211	2.25, 2.299	2XD 012 160-971	3.32	2XS 205 020-041	2.190	2ZR 006 609-171	2.195
2VP 345 900-221	2.25, 2.299	2XD 012 160-981	3.32	2XS 205 020-047	2.190	2ZR 006 609-177	2.195
2VP 345 900-231	2.25, 2.299	2XD 012 480-001	3.23	2XS 205 020-051	2.190	2ZR 008 221-051	2.78
2VP 345 900-241	2.26, 2.300	2XD 012 480-011	3.23	2XS 205 020-057	2.190	2ZR 008 221-057	2.78
2VP 345 900-251	2.26, 2.300	2XD 012 480-101	3.23	2XS 205 020-121	2.190	2ZR 008 221-157	2.78
2VP 345 900-261	2.26, 2.300	2XD 012 480-111	3.23	2XS 205 020-127	2.190	2ZR 008 805-041	2.132
2VP 345 900-271	2.26, 2.300	2XD 012 480-201	3.23	2XS 205 020-131	2.190	2ZR 008 805-047	2.132
2VP 345 900-331	2.27, 2.301	2XD 012 480-211	3.23	2XS 205 020-137	2.190	2ZR 008 805-247	2.132
2VP 345 900-341	2.27, 2.301	2XD 012 480-301	3.23	2XS 205 020-151	2.190	2ZR 009 001-011	2.84
2VP 345 900-401	2.25, 2.299	2XD 012 480-311	3.23	2XS 205 020-157	2.190	2ZR 009 001-017	2.84
2VP 345 900-411	2.25, 2.299	2XD 171 067-051	3.40-3.41	2XS 205 020-171	2.190	2ZR 009 001-117	2.84
2VP 345 900-421	2.25, 2.299	2XD 171 067-251	3.42, 3.64	2XS 205 020-177	2.190	2ZR 011 172-101	2.76
2VP 345 900-431	2.25, 2.299	2XD 176 212-001	3.71	2XS 302 240-031	2.322	2ZR 011 172-107	2.76
2VP 345 900-441	2.26, 2.300	2XD 176 212-011	3.63-3.70	2XS 302 240-051	2.322	2ZR 011 172-501	2.76
2VP 345 900-451	2.26, 2.300	2XD 176 212-021	3.63-3.70	2XS 302 241-071	2.322	2ZR 011 172-507	2.76
2VP 345 900-461	2.26, 2.300	2XD 176 216-001	3.71	2XS 302 241-081	2.322	2ZR 012 456-001	2.198
2VP 345 900-471	2.26, 2.300	2XD 176 216-011	3.63-3.70	2XS 340 447-001	2.321	2ZR 012 456-007	2.198
2VP 357 016-011	2.341	2XD 176 235-001	3.37-3.38, 3.40-3.47, 3.49-3.52, 3.63-3.70	2XS 340 447-021	2.321	2ZR 012 456-011	2.198
2VP 357 016-021	2.341			2XS 340 448-001	2.320	2ZR 012 456-017	2.198
2VP 357 016-111	2.341	2XD 861 423-011	3.29	2XS 340 448-011	2.320	2ZR 012 456-021	2.198
2VP 357 016-121	2.341	2XD 861 423-021	3.29	2XS 340 827-001	2.321	2ZR 012 456-027	2.198
2VP 357 017-011	2.341	2XD 959 011-021	3.29	2XS 340 827-011	2.321	2ZR 012 456-031	2.198
2VP 357 017-021	2.341	2XL...		2XS 340 827-121	2.321	2ZR 012 456-037	2.198
2VP 357 018-001	2.342	2XL 004 762-001	2.56	2XS 340 827-131	2.321	2ZR 012 456-201	2.198
2VP 357 019-001	2.342	2XM...		2XS 357 003-001	2.362	2ZR 012 456-207	2.198
2VP 357 019-011	2.342	2XM 004 444-001	2.246	2XS 357 004-011	2.361	2ZR 012 456-211	2.198
2VP 357 021-011	2.344	2XM 004 444-011	2.246	2XS 357 004-021	2.361	2ZR 012 456-221	2.198
2VP 357 021-031	2.344	2XS...		2XS 357 004-031	2.361	2ZR 012 456-227	2.198
2VP 357 021-041	2.344	2XS 003 168-071	2.192	2XS 357 005-011	2.360	2ZR 012 456-231	2.198
2VP 998 232-261	2.50	2XS 003 168-081	2.192	2XS 357 005-021	2.360	2ZR 012 456-237	2.198
2VP 998 232-301	2.50	2XS 003 738-037	2.187	2XS 357 005-031	2.360	2ZR 013 236-051	2.122
2VP 998 233-281	2.51	2XS 005 020-001	2.189, 2.324	2XS 357 005-041	2.360	2ZR 013 236-061	2.122
2XA...		2XS 005 020-002	2.189	2XS 357 006-011	2.359	2ZR 013 236-111	2.124
2XA 008 221-021	2.77	2XS 005 020-003	2.189	2XS 357 006-021	2.359	2ZR 013 236-121	2.124
2XA 008 221-027	2.77	2XS 005 020-011	2.189, 2.324	2XS 357 007-021	2.359	2ZR 013 236-251	2.122
2XA 959 560-401	2.167	2XS 005 020-017	2.189	2XS 950 071-031	2.187, 2.323	2ZR 013 236-261	2.122
2XA 959 560-407	2.167	2XS 005 020-021	2.189, 2.324	2XS 955 031-001	2.187, 2.323	2ZR 013 236-311	2.124
2XA 959 560-411	2.167	2XS 005 020-041	2.189, 2.324	2XS 955 031-017	2.187, 2.323	2ZR 013 236-321	2.124
2XA 959 560-417	2.167	2XS 005 020-047	2.189	2XS 955 232-001	2.187, 2.323	2ZR 302 252-047	2.88
2XA 959 790-401	2.155	2XS 005 020-057	2.189	2XS 955 232-017	2.187	2ZR 343 130-041	2.112
2XA 959 790-407	2.155	2XS 005 020-067	2.189	2XS 955 260-001	2.188	2ZR 343 130-047	2.112
2XA 959 790-411	2.155	2XS 005 020-077	2.189	2XS 955 260-007	2.188	2ZR 343 130-387	2.107
2XD...		2XS 005 020-081	2.189	2XS 955 401-001	2.157	2ZR 343 130-607	2.112
2XD 003 022-061	2.208	2XS 005 020-091	2.189, 2.324	2XS 955 405-407	2.157	2ZR 344 169-157	2.102
2XD 008 997-001	3.33	2XS 005 020-111	2.189, 2.324	2XS 955 441-001	2.157	2ZR 344 169-167	2.102
2XD 008 997-011	3.33	2XS 005 020-121	2.189	2XS 955 447-001	2.157	2ZR 344 200-051	2.93, 2.315
2XD 008 997-021	3.33	2XS 005 020-137	2.189	2XS 955 451-001	2.157	2ZR 344 200-057	2.93
2XD 008 997-101	3.34	2XS 005 639-001	2.117	2XS 955 457-001	2.157	2ZR 357 025-021	2.348
2XD 008 997-201	3.33	2XS 005 639-002	2.117	2XS 963 959-031	2.143	2ZR 357 026-041	2.354
2XD 008 997-211	3.33	2XS 007 841-011	2.188	2XS 963 959-037	2.143	2ZR 357 027-041	2.355
2XD 008 997-221	3.33	2XS 007 841-017	2.188	2XS 964 295-031	2.153	2ZR 357 028-041	2.356
2XD 008 997-231	3.33	2XS 007 841-021	2.188	2XS 964 295-037	2.153	2ZR 357 029-051	2.350
2XD 008 997-241	3.33	2XS 008 078-001	2.191, 2.324	2XT...		2ZR 357 029-151	2.350
2XD 008 997-251	3.33	2XS 008 078-007	2.191	2XT 002 452-037	2.248	2ZR 959 010-501	2.91, 2.310
2XD 009 048-001	3.33	2XS 008 078-011	2.191	2XT 002 945-027	2.249	2ZR 959 010-507	2.91, 2.310
2XD 009 048-011	3.33	2XS 008 078-017	2.191	2XT 007 945-077	2.249	2ZR 959 820-601	2.103, 2.306
2XD 009 048-021	3.33	2XS 008 479-001	2.191	2XT 008 929-001	2.249	2ZR 964 169-031	2.102
2XD 009 048-101	3.34	2XS 008 479-007	2.191	2XT 008 929-007	2.249	2ZR 964 169-037	2.102
2XD 009 048-101	3.34	2XS 008 479-011	2.191	2XT 009 098-001	2.248	2ZR 964 169-107	2.102
2XD 009 048-201	3.33	2XS 008 479-017	2.191	2XT 009 098-017	2.248	2ZR 964 169-351	2.96
2XD 009 048-211	3.33	2XS 008 479-041	2.191	2XT 009 098-107	2.248	2ZR 964 169-361	2.96
2XD 009 048-221	3.33	2XS 008 479-047	2.191	2XT 009 098-107	2.248	2ZR 964 169-511	2.97
2XD 009 048-251	3.33	2XS 008 479-051	2.191	2XT 009 098-307	2.248	2ZR 964 169-517	2.97
2XD 009 048-261	3.33	2XS 008 479-057	2.19				

List of part numbers



Part number	Page	Part number	Page	Part number	Page	Part number	Page
3SL...		8GA...		8GH...		8GS...	
3SL 009 678-801	3.74	8GA 002 071-121	4.12	8GH 007 157-201	4.07	8GS 009 028-111	4.05
4AZ...		8GA 002 071-123	4.12	8GS 009 028-311	4.07	8GS 009 028-621	4.05
4AZ 003 787-021	2.213	8GA 002 071-131	4.12	8GH 007 157-241	4.07	8GS 859 634-001	3.16-3.17, 3.54, 3.59
4DM...		8GA 002 071-133	4.12	8GH 007 157-248	4.07	8GS 861 710-001	3.29-3.29
4DM 009 492-001	2.07	8GA 002 071-241	4.12	8GH 007 157-451	4.07	8GS 861 953-011	4.16
4DN...		8GA 002 071-248	4.12	8GH 007 157-453	4.07	8GS 861 955-001	4.16
4DN 009 492-101	2.07	8GA 002 071-251	4.12	8GH 007 157-471	4.07	8GS 861 955-011	4.16
4DW...		8GA 002 071-258	4.12	8GH 007 157-473	4.07	8GS 861 955-021	4.16
4DW 009 492-011	2.07, 2.14-2.16, 2.295-2.297	8GA 002 071-261	4.12	8GH 007 157-481	4.07	8GS 861 955-031	4.16
4JZ...		8GA 002 071-271	4.12	8GH 007 157-531	4.07	8GS 863 261-001	3.14-3.15, 3.18
4JZ 177 846-007	2.58, 2.61, 2.93-2.95, 2.305, 2.308, 2.312-2.314	8GA 002 071-361	4.12	8GH 007 157-901	4.03	8GS 863 889-001	3.54
4RA...		8GA 002 072-121	4.12	8GH 007 157-913	4.03	8HG...	
4RA 003 530-001	1.35	8GA 002 072-241	4.12	8GH 007 157-931	4.03	8HG 002 240-001	2.260
4RA 003 530-051	1.35	8GA 002 073-121	4.11	8GH 007 157-941	4.03	8HG 002 240-021	2.260
4RA 933 791-061	2.171	8GA 002 073-123	4.11	8GH 007 643-121	4.12	8HG 002 240-031	2.260
4RA 965 400-001	1.11, 1.28-1.29	8GA 002 073-241	4.11	8GH 008 356-121	4.07	8HG 002 247-001	2.113-2.114
4RD...		8GA 002 073-248	4.11	8GH 008 356-181	4.07	8HG 002 365-001	1.187, 3.24
4RD 933 332-041	2.176-2.179	8GA 002 073-251	4.11	8GH 008 357-001	4.07	8HG 003 799-001	2.117, 2.255-2.256
4RD 933 332-061	2.176-2.179	8GA 002 074-121	4.11	8GH 008 358-121	4.07	8HG 003 799-007	2.117, 2.255-2.256
5DF...		8GA 002 074-241	4.11	8GH 008 358-151	4.07	8HG 003 799-017	2.117, 2.255-2.256
5DF 009 244-007	1.10, 1.51	8GA 002 083-131	4.10	8GH 008 358-181	4.07	8HG 004 806-001	1.111-1.112, 1.119, 1.125, 1.190
5DF 980 816-001	2.178-2.179	8GA 002 083-251	4.10	8GH 008 358-241	4.07	8HG 005 436-011	3.18, 3.28
5DF 980 816-051	2.177	8GA 006 841-121	4.12	8GH 008 358-251	4.07	8HG 006 294-011	1.187, 3.24
5DF 980 816-501	2.178-2.179	8GA 006 841-123	4.12	8GH 008 358-254	4.07	8HG 006 294-021	1.129, 1.132, 1.187, 3.24
5DF 980 816-551	2.177	8GA 006 841-801	4.12	8GH 008 358-254	4.07	8HG 006 294-031	1.187, 3.24
5DK...		8GA 007 997-001	4.16	8GH 008 358-254	4.07	8HG 006 294-051	1.187, 3.24
5DK 009 678-001	3.63-3.70	8GA 007 997-011	4.16	8GH 178 560-471	4.09	8HG 006 294-091	1.187, 3.24
5DK 009 678-021	3.63-3.70	8GA 007 997-021	4.16	8GH 178 560-493	4.07	8HG 006 294-101	1.187, 3.24
5DK 009 678-031	3.63-3.64	8GA 007 997-041	4.16	8GJ...		8HG 006 294-111	1.187, 3.24
5DS...		8GA 007 997-051	4.17	8GJ 002 525-001	4.08	8HG 006 294-131	1.187, 3.24
5DS 009 552-001	2.07, 2.330	8GA 007 997-061	4.16	8GJ 002 525-131	4.08	8HG 006 294-141	3.24
5DS 009 552-011	2.07	8GA 007 997-071	4.17	8GJ 002 525-136	4.08	8HG 006 294-151	3.24
5DS 009 552-031	2.61, 2.308	8GA 007 997-081	4.17	8GJ 002 525-251	4.08	8HG 096 531-007	1.187, 3.24
5DS 009 602-001	2.07, 2.14-2.16, 2.295-2.297	8GA 007 997-091	4.17	8GJ 002 525-258	4.08	8HG 116 741-801	1.181-1.19, 1.22, 1.24-1.25, 1.35
5DS 009 602-011	2.07	8GA 007 997-101	4.17	8GJ 002 525-281	4.08	8HG 151 866-001	1.42-1.43
5DS 010 668-701	2.172-2.173	8GA 007 997-111	4.17	8GJ 002 525-301	4.08	8HG 153 152-001	1.36, 1.161
5DS 010 668-711	2.172-2.173	8GA 007 997-121	4.18	8GJ 002 525-361	4.08	8HG 159 455-001	1.186
5DS 011 668-001	1.46, 1.49-1.50	8GA 007 997-131	4.18	8GJ 002 525-366	4.08	8HG 160 409-002	2.148-2.150, 2.262, 2.268, 2.316
5DS 011 630-011	1.46, 1.49-1.50	8GA 007 997-141	4.18	8GJ 002 525-471	4.08	8HG 162 530-002	2.85
5DS 011 630-011	2.340, 2.342-2.346, 2.348-2.349,	8GA 007 997-151	4.18	8GJ 002 525-473	4.08	8HG 165 967-001	2.175
5DS 357 030-001	2.354-2.356, 2.340, 2.342-2.346, 2.348-2.349, 2.354-2.356	8GA 007 997-161	4.17	8GJ 002 525-481	4.08	8HG 168 011-001	3.36
5DS 537 030-001	2.341	8GA 007 997-171	4.18	8GJ 002 525-511	4.08	8HG 174 791-401	3.71
5DS 537 030-101	2.341	8GA 007 997-181	4.16	8GJ 002 525-531	4.08	8HG 174 791-411	3.71
5DV...		8GA 007 997-191	4.19	8GJ 002 525-534	4.08	8HG 183 586-001	1.55
5DV 007 760-631	1.12, 1.17, 1.25, 1.36, 1.38-1.39, 1.42-1.43, 1.48	8GA 007 997-201	4.19	8GJ 002 525-891	4.08	8HG 184 521-001	3.30
5DV 007 810-171	1.25, 1.38-1.39, 1.42-1.43, 1.48, 1.54, 1.88, 1.101	8GA 007 997-211	4.18	8GJ 002 525-893	4.08	8HG 334 414-372	1.189
5DV 008 855-001	1.25, 1.34, 1.132, 1.134	8GA 007 997-221	4.18	8GJ 002 525-913	4.04	8HG 332 912-002	1.189
5DV 008 855-001	1.134	8GA 007 997-231	4.19	8GJ 002 525-941	4.04	8HG 340 413-001	2.148-2.150, 2.262, 2.268, 2.316
5DV 008 856-007	1.132, 1.134	8GA 007 997-241	4.18	8GJ 002 525-971	4.04	8HG 341 300-007	2.268, 2.316
5DV 010 286-001	1.25, 1.118-1.120	8GA 007 997-271	4.19	8GJ 002 133-242	4.08	8HG 854 516-001	3.72
5DV 010 286-011	1.25, 1.118-1.121	8GA 007 997-901	4.05	8GJ 004 173-121	4.08	8HG 860 608-011	3.63-3.70
5DV 990 264-001	1.133, 1.155	8GA 008 246-001	4.14	8GJ 008 837-121	4.06	8HG 863 383-001	3.72, 3.74-3.75
5DV 990 264-011	1.133, 1.154-1.155	8GA 008 892-002	4.14	8GJ 168 119-001	4.06	8HG 958 000-011	2.236
5KG...		8GA 008 899-061	4.10	8GJ 168 119-241	4.06	8HG 958 000-021	2.236
5KG 007 629-001	3.18, 3.25, 3.28	8GA 008 899-121	4.10	8GJ 178 560-481	4.06	8HG 980 793-801	2.174
5KG 007 629-011	3.18, 3.25, 3.28	8GA 008 901-241	4.15	8GJ 178 560-483	4.08	8HG 980 793-811	2.174
5KG 009 713-001	3.34	8GD...		8GM...		8HG 980 795-801	2.174
5XA...		8GD 002 078-011	4.11	8GM 002 091-121	4.13	8HG 980 795-811	2.174
5XA 344 150-011	2.227, 2.230	8GD 002 078-121	4.11	8GM 002 091-131	4.13	8HG 980 797-801	2.174
6EB...		8GD 002 078-221	4.11	8GM 002 091-141	4.13	8HG 980 797-811	2.174
6EB 005 633-001	1.83-1.85, 1.180	8GD 002 078-241	4.11	8GM 002 091-181	4.13	8HG 980 797-811	2.174
6ED...		8GD 002 078-248	4.11	8GM 002 091-241	4.13	8HG 980 797-811	2.174
6ED 004 778-001	3.34	8GD 002 084-131	4.10	8GM 002 091-251	4.13	8HG 980 854-101	2.178
6ED 004 778-011	3.55, 3.60	8GD 002 084-151	4.10	8GM 002 092-121	4.13	8HG 980 864-101	2.179
6ED 708 919-001	1.182	8GD 002 084-251	4.10	8GM 002 092-123	4.13	8HG 980 975-101	2.177
6EG...		8GD 002 088-141	4.10	8GM 002 092-241	4.13	8HG 990 003-001	1.178-1.179
6EG 001 567-041	1.12, 1.31	8GD 002 088-143	4.10	8GM 002 094-121	4.13	8HG 990 263-001	1.130
6EH...		8GD 002 088-271	4.10	8GM 002 094-241	4.13	8HG 990 263-111	1.90-1.98, 1.111-1.112, 1.117-1.118, 1.120, 1.125-1.129, 1.131, 1.158-1.159, 1.164-1.165, 1.188
6EH 007 946-001	1.11, 1.35-1.36	8GD 004 772-121	4.11	8GP...		8HG 990 263-131	1.188
6NM...		8GD 004 772-123	4.11	8GP 002 066-121	4.14	8HG 990 320-001	1.118, 1.120, 1.129, 1.132, 1.188
6NM 004 375-541	1.54	8GD 008 893-002	4.11	8GP 002 066-241	4.14	8HG 990 320-011	1.132, 1.188
6NM 007 231-037	1.65	8GD 008 897-061	4.10	8GP 002 067-013	4.11, 4.13	8HG 990 368-001	1.187, 3.24
6NM 007 282-221	1.39, 1.44, 1.46, 1.48	8GD 008 897-121	4.10	8GP 002 067-061	4.11, 4.13	8HG 990 368-007	1.187, 3.24
6NM 007 282-231	1.39, 1.48	8GD 008 898-061	4.10	8GP 002 067-121	4.11, 4.13	8HG 992 377-042	1.189
6NM 008 299-501	1.44, 1.46	8GH...		8GP 002 067-123	4.11, 4.13	8HG 994 412-372	1.189
6ZE...		8GH 002 089-133	4.09	8GP 002 067-241	4.11, 4.13	8HG 994 974-002	1.189
6ZE 001 759-051	3.75	8GH 002 089-136	4.09	8GP 002 067-261	4.11, 4.13	8HG 998 519-002	1.191
6ZE 001 759-071	3.75	8GH 002 089-146	4.09	8GP 002 068-121	4.14	8JA...	
8EN...		8GH 002 089-251	4.09	8GP 002 068-131	4.14	8JA 001 909-001	4.20
8EN 332 584-001	1.190	8GH 002 089-253	4.09	8GP 002 068-241	4.14	8JA 001 909-011	4.20
		8GH 002 089-258	4.09	8GP 002 095-121	4.15	8JA 001 914-011	4.20
		8GH 002 089-351	4.09	8GP 002 095-241	4.15	8JA 001 915-001	1.119, 1.125, 1.130
		8GH 002 089-361	4.09	8GP 002 096-061	4.14	8JA 001 921-102	1.191
		8GH 002 089-471	4.09	8GP 003 594-121	4.15	8JA 001 925-001	1.185
		8GH 002 089-491	4.09	8GP 003 594-123	4.15	8JA 001 930-001	2.56
		8GH 002 089-501	4.09	8GP 003 594-141	4.15	8JA 002 263-031	1.130
		8GH 002 089-531	4.09	8GP 003 594-241	4.15	8JA 003 526-001	2.58, 2.61, 2.93-2.95, 2.305, 2.308, 2.312-2.314
		8GH 002 090-133	4.09	8GP 007 676-121	4.14	8JA 004 667-001	2.246
		8GH 002 090-136	4.09	8GP 008 285-001	4.14	8JA 007 158-001	2.246
		8GH 002 090-251	4.09	8GP 009 021-002	4.15	8JA 201 022-042	1.46



List of part numbers

Part number	Page	Part number	Page	Part number	Page	Part number	Page
8JB...		8KB...		8RA...		9BG...	
8JB 001 933-001	1.130	8KB 863 949-001	4.20	8RA 344 065-007	2.40	9BG 128 652-021	2.125
8JB 001 943-001	2.56	8KB 863 949-011	4.20	8RA 344 610-017	2.196	9BG 130 945-001	2.23
8JB 004 777-001	3.09, 3.25	8KB 864 105-801	3.72, 3.74	8RA 964 292-001	2.188	9BG 130 946-001	2.23
8JB 004 777-002	3.09	8KB 990 299-001	1.86-1.87, 1.90-1.94, 1.117, 1.124-1.127, 1.129-1.131, 1.142, 1.146, 1.158, 1.166, 2.197, 2.329	8RB...		9BG 154 271-001	2.204
8JB 850 434-011	1.187, 3.24			8RB 004 713-001	2.257	9BG 209 213-001	3.65-3.66
8JD...		8KB 990 299-011		8RL...		9BG 856 420-007	3.26
8JD 008 151-011	1.86-1.87, 1.90-1.94, 1.97-1.98, 1.117-1.118, 1.120, 1.124-1.127, 1.129-1.130, 1.158, 2.197, 2.329			8RL 002 009-021	2.258	9BG 859 695-101	3.26
8JD 008 151-041	1.78, 1.102-1.103, 1.105	8KB 990 299-121		8RW...		9BG 859 695-111	3.26
8JD 008 151-051	1.76-1.78			8RW 341 235-007	2.254	9BG 990 042-061	1.105
8JD 156 150-807	1.36-1.38, 1.42-1.43, 1.47, 1.161, 2.38-2.39, 2.81-2.85, 2.196	8KB 990 299-221		8WS...		9BG 990 342-001	1.85-1.88
8JD 156 151-807	1.38-1.39, 1.42-1.44, 1.46-1.49, 1.54, 1.88, 1.101			8WS 008 549-001	1.54-1.55	9BG 990 353-001	1.124
8JD 158 175-807	1.131, 1.174	8KB 990 299-241		8WS 008 549-501	1.54-1.55	9BG 993 345-001	1.102-1.103, 1.105
8JD 162 211-801	1.47	8KB 990 299-251		8WT...		9DE...	
8JD 162 581-802	1.41, 2.39, 2.81-2.83, 2.85, 2.218	8KB 990 299-311		8WT 008 549-101	1.55	9DE 128 657-001	2.129
8JE...		8KB 990 299-331		8WT 008 549-201	1.55	9DE 128 658-001	2.129
8JE 340 060-001	2.334	8KB 990 299-361		8WT 008 549-601	1.55	9DE 132 750-015	1.67
8JE 340 060-011	2.334	8KL...		8XH...		9DF...	
8JE 340 060-251	2.334	8KL 340 009-001	2.336	8XH 002 975-017	2.252	9DF 112 246-001	1.32
8JE 340 151-001	2.273, 2.334	8KL 340 050-001	2.338	8XS...		9DR...	
8JE 340 165-001	2.335	8KL 340 055-021	2.336	8XS 113 389-001	2.209	9DR 060 567-001	1.69
8JE 340 867-011	2.335	8KL 340 059-001	2.336	8XS 147 945-001	1.25	9DR 066 847-001	1.68
8JE 340 898-001	2.335	8KL 340 412-001	2.336	8XS 147 945-011	1.25	9DR 090 206-001	1.69
8JS...		8KL 998 228-021	2.338	8XS 165 048-001	1.14-1.16	9DR 104 336-001	1.66
8JS 711 687-821	1.97, 1.104, 1.118-1.120, 1.122-1.123, 1.185	8KW...		8XS 165 048-011	1.16	9DS...	
8KA...		8KW 701 235-033	1.76-1.78, 1.86-1.87, 1.90-1.94, 1.97-1.98, 1.102-1.103, 1.105, 1.117-1.118, 1.120, 1.124-1.130, 1.158, 2.197, 2.329	8XS 186 531-012	1.13	9DS 188 583-001	1.60
8KA 002 309-811	1.18-1.19, 1.35	8KW 744 808-801		8XS 186 532-012	1.30, 1.32	9DS 121 707-001	1.177, 1.180
8KA 144 707-007	2.202, 2.204	8KW 744 837-002		8XS 199 170-011	1.16	9DS 180 786-011	1.20, 1.24
8KA 146 751-007	2.202-2.204			8XS 340 092-011	2.272-2.275	9DW...	
8KA 146 751-017	2.202	8KW 863 933-013	1.76-1.78, 1.86-1.87, 1.90-1.94, 1.97-1.98, 1.102-1.103, 1.105, 1.117-1.118, 1.120, 1.124-1.130, 1.158, 2.197, 2.329	8XT...		9DW 168 426-801	3.38, 3.42-3.44, 3.49-3.52, 3.63-3.70
8KA 152 134-007	2.77-2.78	8KW 998 602-002	2.268, 2.316, 2.318-2.321, 2.327	8XT 002 117-001	1.186	9DW 168 426-811	2.271-2.272, 2.274-2.275
8KA 157 425-007	2.216	8PE...		8XT 002 120-001	1.186	9DW 178 909-001	2.271-2.272, 2.274
8KA 165 959-001	2.172-2.173, 2.175-2.176, 2.179	8PE 008 932-001	2.148-2.150, 2.262, 2.268, 2.316, 2.318-2.321, 2.327, 2.338	8XT 002 121-001	1.186	9DW 178 909-011	2.271-2.272, 2.274
8KA 178 692-801	3.63-3.70	8PY...		8XU...		9DW 194 222-801	2.13, 2.294
8KA 194 768-001	1.50	8PY 191 978-801	3.63-3.70	8XU 008 405-031	2.75-2.78	9DW 195 804-001	2.122, 2.124-2.125
8KA 194 768-011	1.50	8RA...		8XU 008 405-037	2.75-2.78	9DW 195 804-011	2.121, 2.124
8KA 194 768-031	1.50	8RA 002 014-231	2.255	8XU 009 362-101	2.79-2.80	9DW 195 804-021	2.121, 2.124
8KA 197 041-001	2.57	8RA 002 014-232	2.255	8XU 009 362-111	2.79-2.80	9DW 195 804-031	2.121, 2.123, 2.125
8KA 197 041-011	2.57	8RA 002 014-242	2.255	8XX...		9DW 195 804-041	2.121, 2.123, 2.125
8KA 202 117-001	1.10, 1.51-1.53	8RA 002 014-252	2.255	8XX 010 315-001	1.39, 1.47-1.48, 1.55	9DW 195 804-051	2.122, 2.124
8KA 202 117-011	1.10, 1.45, 1.47	8RA 002 014-251	2.255	8XX 010 315-011	1.39, 1.47-1.48, 1.55	9DW 195 804-061	2.122, 2.124-2.125
8KA 340 031-001	2.333	8RA 002 014-252	2.255	8XX 010 315-101	1.39, 1.47-1.48, 1.55	9DW 195 804-071	2.121, 2.124
8KA 340 815-001	2.332	8RA 002 014-281	2.255	9AB...		9DW 195 804-181	2.123, 2.125
8KA 340 815-011	2.332	8RA 002 014-291	2.255	9AB 194 559-001	2.216	9DW 195 804-191	2.123, 2.125
8KA 340 815-021	2.332	8RA 002 014-301	2.255	9AB 343 792-061	2.225	9DW 195 804-211	2.122, 2.124-2.125
8KA 340 816-001	2.332	8RA 002 014-327	2.255	9AB 343 792-071	2.225	9DW 195 804-221	2.121, 2.124
8KA 340 816-041	2.332	8RA 002 015-031	2.256	9AB 344 045-061	2.228-2.231	9DW 195 804-231	2.121, 2.123
8KA 340 817-011	2.332	8RA 002 016-101	2.256	9AB 344 045-071	2.228-2.231	9DW 195 804-241	2.121, 2.123, 2.125
8KA 340 818-001	2.331	8RA 002 016-111	2.256	9AB 344 057-001	2.224, 2.227-2.231	9DW 195 804-251	2.122, 2.124
8KA 340 818-011	2.331	8RA 002 016-121	2.256	9AB 344 057-011	2.224, 2.227-2.231	9DW 195 804-261	2.122, 2.124-2.125
8KA 340 818-021	2.331	8RA 002 020-001	2.56, 2.259, 2.328	9AB 344 057-061	2.227-2.231	9DW 195 804-271	2.121, 2.123, 2.125
8KA 340 819-001	2.332	8RA 002 020-002	2.259	9AB 344 057-071	2.227-2.231	9DW 195 804-381	2.123, 2.125
8KA 340 819-121	2.332	8RA 002 020-051	2.259	9AB 344 058-001	2.224, 2.227-2.231	9DW 195 804-391	2.123, 2.125
8KA 340 822-071	2.331	8RA 002 023-001	2.258	9AB 344 058-011	2.224, 2.227-2.231	9DW 196 483-001	1.34
8KA 340 841-001	2.331	8RA 002 023-011	2.258	9AB 344 058-061	2.227-2.231	9DW 209 487-001	2.59
8KA 340 841-021	2.331	8RA 002 023-021	2.258	9AB 344 058-071	2.227-2.231	9DX...	
8KA 340 842-001	2.331	8RA 003 326-001	2.257	9AB 344 059-001	2.224, 2.227-2.231	9DX 119 545-011	2.126
8KA 340 842-011	2.331	8RA 003 326-002	2.257	9AB 344 059-011	2.224, 2.227-2.231	9DX 119 545-051	2.239
8KA 340 843-001	2.331	8RA 003 326-011	2.18, 2.257, 2.293	9AB 344 059-061	2.227-2.231	9DX 859 560-001	3.26-3.27
8KA 340 843-011	2.331	8RA 003 326-017	2.257	9AB 344 059-071	2.227-2.231	9DX 859 625-001	3.26-3.27
8KA 340 843-021	2.331	8RA 003 326-021	2.257	9AB 344 059-071	2.227-2.231	9DX 859 626-001	3.62
8KA 340 845-031	2.333	8RA 003 326-031	2.257	9AB 344 059-071	2.227-2.231	9DX 860 271-001	3.04-3.05
8KA 340 846-001	2.333	8RA 003 326-041	2.257	9AB 344 059-071	2.227-2.231	9DX 860 438-001	3.04
8KA 340 859-001	2.333	8RA 003 326-047	2.257	9AB 344 059-071	2.227-2.231	9DX 861 976-001	3.56-3.57
8KA 340 859-011	2.333	8RA 003 326-051	2.257	9AB 344 059-071	2.227-2.231	9DX 862 740-001	3.10-3.11
8KA 340 864-011	2.333	8RA 003 326-051	2.257	9AB 344 059-071	2.227-2.231	9DX 862 742-001	3.13
8KA 950 073-001	2.169, 2.187, 2.323	8RA 003 326-931	2.257	9AB 344 059-071	2.227-2.231	9DX 862 844-001	3.04
8KA 959 186-801	2.178-2.179	8RA 003 503-001	2.259	9AB 344 059-071	2.227-2.231	9DX 862 849-001	3.56-3.57
8KA 959 186-811	2.178-2.179	8RA 003 660-007	2.258	9AB 344 059-071	2.227-2.231	9EL...	
8KA 962 886-001	2.187, 2.323	8RA 003 734-101	2.136, 2.258	9AB 344 059-071	2.227-2.231	9EL 043 137-001	2.251
8KA 998 229-011	2.338	8RA 004 412-001	2.256	9AB 344 059-071	2.227-2.231	9EL 052 476-001	2.54
8KA 998 230-001	2.338	8RA 004 412-011	2.256	9AB 344 059-071	2.227-2.231	9EL 074 484-011	2.208
8KA 998 230-121	2.47, 2.49, 2.51	8RA 004 412-021	2.256	9AB 344 059-071	2.227-2.231	9EL 074 484-031	2.208
8KA 998 240-071	2.338	8RA 008 405-001	2.74	9AB 344 059-071	2.227-2.231	9EL 085 408-001	2.213
8KB...		8RA 008 405-007	2.74	9AB 344 059-071	2.227-2.231	9EL 085 478-001	2.210
8KB 149 147-001	1.104, 1.133, 1.155	8RA 009 001-031	2.84	9AB 344 059-071	2.227-2.231	9EL 087 769-001	2.219
8KB 161 334-007	1.18, 1.23	8RA 009 001-037	2.84	9AB 344 059-071	2.227-2.231	9EL 088 150-001	2.115
8KB 163 160-801	1.10	8RA 009 226-117	2.158	9AB 344 059-071	2.227-2.231	9EL 088 525-001	2.113
8KB 163 160-811	1.51	8RA 009 226-127	2.158	9AB 344 059-071	2.227-2.231	9EL 088 538-001	2.114
8KB 173 872-001	3.71	8RA 009 226-137	2.158	9AB 344 059-071	2.227-2.231	9EL 089 114-001	2.73
8KB 174 934-001	3.71, 3.73	8RA 009 362-001	2.79-2.80	9AB 344 059-071	2.227-2.231	9EL 091 749-011	2.239
8KB 174 943-001	3.71, 3.73	8RA 123 251-005	2.68	9AB 344 059-071	2.227-2.231	9EL 092 435-011	2.24
8KB 174 943-011	3.63-3.70	8RA 342 014-157	2.256	9AB 344 059-071	2.227-2.231	9EL 101 353-001	2.89, 2.307
8KB 175 501-001	3.74	8RA 343 160-002	2.155	9AB 344 059-071	2.227-2.231	9EL 102 240-031	2.63
8KB 178 139-001	2.172-2.173	8RA 343 160-017	2.155	9AB 344 059-071	2.227-2.231	9EL 104 571-031	2.53
8KB 178 139-002	2.172-2.173	8RA 343 160-022	2.155	9AB 3			

List of part numbers



Part number	Page	Part number	Page	Part number	Page	Part number	Page
9EL...		9EL...		9EL...		9GD...	
9EL 113 324-001	2.62, 2.308	9EL 172 563-001	3.39, 3.63	9EL 950 315-001	2.187, 2.323	9GD 862 080-001	3.60
9EL 113 639-021	1.79	9EL 172 563-011	3.42, 3.49-3.51, 3.53, 3.64-3.70	9EL 950 315-031	2.187, 2.323	9GD 862 081-001	3.60
9EL 113 928-001	2.201	9EL 172 563-101	3.63	9EL 950 315-061	2.187, 2.323	9GD 862 085-001	3.60
9EL 114 401-001	2.144	9EL 172 563-111	3.42, 3.49-3.51, 3.64-3.68, 3.70	9EL 963 983-001	2.143	9GD 862 164-001	3.10, 3.12, 3.16, 3.25
9EL 114 401-031	2.144	9EL 172 563-221	3.37-3.38, 3.63	9EL 963 984-001	2.143	9GD 862 178-001	3.13
9EL 114 401-041	2.144	9EL 172 563-241	3.43-3.53, 3.65-3.70	9EL 964 289-001	2.188	9GD 862 734-001	3.13
9EL 115 003-001	2.118	9EL 172 563-251	3.40-3.41, 3.43-3.48, 3.52	9EL 964 290-001	2.188	9GD 863 033-001	3.25
9EL 115 003-011	2.118	9EL 172 563-321	3.37-3.38, 3.63	9EL 964 526-001	2.100	9GD 863 952-002	1.51-1.53
9EL 115 003-021	2.118	9EL 172 563-351	3.40-3.41, 3.43-3.48, 3.52	9EL 964 527-001	2.100	9GD 863 952-012	1.51-1.53
9EL 115 003-035	2.118	9EL 172 563-321	3.37-3.38, 3.63	9EL 964 529-001	2.102	9GD 863 952-022	1.51-1.53
9EL 115 003-055	2.119	9EL 172 563-351	3.40-3.41, 3.43-3.48, 3.52	9EL 964 530-001	2.101	9GD 864 286-011	3.55
9EL 115 830-001	2.214	9EL 172 564-011	3.37, 3.39-3.40, 3.44, 3.49, 3.63-3.70	9EL 964 531-001	2.101	9GD 963 281-001	2.137
9EL 116 607-005	2.220	9EL 172 564-101	3.37, 3.39-3.40, 3.44, 3.63-3.70	9EL 964 532-001	2.99	9GD 980 696-001	2.90-2.91, 2.218, 2.309-2.310
9EL 116 844-001	2.67	9EL 174 214-011	3.42-3.43, 3.63-3.70	9EL 964 533-001	2.102		
9EL 116 907-001	2.208	9EL 174 215-011	3.42-3.43, 3.63-3.70	9EL 964 534-001	2.100		
9EL 117 330-001	2.116	9EL 174 995-001	3.21	9EL 964 536-001	2.98	9GH...	
9EL 117 330-011	2.116	9EL 181 506-001	3.19	9EL 990 034-041	2.120	9GH 096 532-001	1.187, 3.24
9EL 117 334-001	2.116	9EL 181 506-011	3.19	9EL 990 142-001	2.54	9GH 116 966-011	1.102
9EL 117 334-021	2.116	9EL 183 432-001	2.271-2.272, 2.274-2.275	9EL 990 186-001	1.68, 1.76-1.77	9GH 126 647-011	1.58, 1.60, 1.62-1.63, 1.79
9EL 118 613-001	2.71	9EL 190 025-001	3.20	9EL 990 267-001	1.73	9GH 145 943-001	1.42, 1.54
9EL 118 614-011	2.71	9EL 190 025-011	3.20	9EL 990 354-011	1.70-1.71	9GH 145 943-012	1.41
9EL 118 614-021	2.71	9EL 190 025-021	3.20	9EL 990 354-021	1.70-1.71	9GH 147 009-007	1.36-1.38, 1.161
9EL 118 633-001	2.73	9EL 190 025-021	3.20	9EL 990 354-031	1.70-1.71	9GH 152 654-007	1.42
9EL 118 697-001	2.68	9EL 190 025-021	3.20	9EL 990 354-041	1.70-1.71	9GH 152 654-012	1.41
9EL 118 700-001	2.68	9EL 190 025-021	3.20	9EL 990 354-121	1.71	9GH 158 051-007	1.40
9EL 118 701-001	2.68	9EL 190 025-021	3.20	9EL 990 354-131	1.71	9GH 331 480-001	1.100
9EL 118 703-001	2.68	9EL 190 025-021	3.20	9EL 990 354-141	1.71	9GH 990 316-031	1.76
9EL 118 705-001	2.68	9EL 190 025-021	3.20	9EL 990 632-001	2.47-2.48	9GH 990 334-011	1.95, 1.165-1.166, 1.174
9EL 119 397-001	2.73	9EL 190 025-021	3.20	9EL 990 632-041	2.47	9GH 993 984-001	1.86-1.87, 1.90-1.94, 1.117-1.118, 1.120, 1.124-1.125, 1.127, 1.129-1.131, 1.153, 1.158, 2.197, 2.329
9EL 119 544-001	2.126-2.127, 2.129-2.130	9EL 190 025-021	3.20	9EL 990 633-031	2.51	1.76-1.78	
9EL 119 544-021	2.126-2.127, 2.129	9EL 208 551-001	2.13, 2.294, 2.15-2.16, 2.296-2.297	9EL 990 633-041	2.51		
9EL 119 544-031	2.126-2.127, 2.129	9EL 208 551-011	2.14, 2.295	9EL 997 310-001	2.52		
9EL 119 544-101	2.129	9EL 209 476-001	2.59	9EL 997 332-001	2.55		
9EL 119 544-111	2.126-2.127, 2.130, 2.239	9EL 209 476-011	2.59	9EL 997 387-001	2.139		
9EL 119 544-212	2.127	9EL 303 581-011	2.321-2.322	9EL 997 441-001	2.24	9GH 993 988-007	
9EL 119 614-031	2.55	9EL 340 201-001	2.285	9EL 997 451-001	2.53		
9EL 119 977-001	2.194	9EL 340 203-001	2.298	9EL 997 452-001	2.53	9GP...	
9EL 120 201-001	2.126-2.127	9EL 340 203-011	2.298	9EL 997 453-001	2.46	9GP 003 995-801	2.21-2.23, 2.36, 2.285, 2.287
9EL 120 224-001	2.219	9EL 340 208-001	2.276-2.277	9EL 997 459-001	2.69	3.04	
9EL 120 240-011	2.238	9EL 340 208-021	2.276-2.277	9EL 997 469-001	2.69		
9EL 121 431-001	2.68	9EL 340 331-001	2.282-2.283	9EL 998 002-031	2.56		
9EL 122 689-021	2.21, 2.23, 2.287	9EL 340 829-001	2.278-2.280				
9EL 122 689-051	2.23	9EL 340 829-011	2.278-2.280	9EM...			
9EL 122 772-001	2.22-2.23, 2.287	9EL 340 829-021	2.278-2.281	9EM 128 229-011	2.104		
9EL 122 772-051	2.23	9EL 340 829-031	2.278-2.281				
9EL 123 632-001	2.135	9EL 340 829-041	2.12, 2.292	9ES 012 060-011	1.69		
9EL 123 635-001	2.135	9EL 340 829-051	2.282-2.283	9ES 015 675-001	1.69		
9EL 126 294-001	2.63	9EL 341 255-011	2.282-2.283	9ES 106 588-001	2.89, 2.307		
9EL 128 922-011	2.244	9EL 343 134-011	2.46	9ES 120 743-001	1.67		
9EL 129 519-001	2.54, 2.56	9EL 343 134-021	2.107, 2.109, 2.112	9ES 199 813-001	1.17		
9EL 131 420-001	2.19, 2.288	9EL 343 134-041	2.108, 2.111				
9EL 131 420-011	2.19, 2.288	9EL 343 134-051	2.107, 2.112	9FF...			
9EL 132 215-001	2.189, 2.324	9EL 343 134-061	2.108	9FF 042 509-001	4.19		
9EL 132 215-011	2.189, 2.324	9EL 343 142-001	2.29-2.31	9FF 071 116-001	4.19		
9EL 132 403-001	2.166, 2.168	9EL 343 143-001	2.29-2.31	9FF 078 830-001	4.19		
9EL 132 404-001	2.166, 2.168	9EL 343 143-011	2.30-2.31	9FF 085 081-001	4.19		
9EL 134 296-041	2.17-2.18, 2.286, 2.293	9EL 357 012-101	2.353	9FF 085 642-001	1.59		
9EL 134 296-051	2.17-2.18, 2.286, 2.293	9EL 357 012-111	2.353	9FF 090 500-001	1.68-1.69		
9EL 134 301-001	2.17-2.18, 2.286, 2.293	9EL 357 012-121	2.353	9FF 111 606-021	1.66, 1.79		
9EL 134 301-011	2.17-2.18, 2.286, 2.293	9EL 357 031-101	2.340	9FF 126 444-001	1.62		
9EL 134 658-001	2.209	9EL 357 032-101	2.347	9FF 133 025-007	4.19		
9EL 134 659-001	2.209	9EL 357 032-111	2.347	9FF 135 906-021	4.19		
9EL 134 660-001	2.209	9EL 357 033-111	2.345	9FF 138 324-001	4.19		
9EL 134 739-001	2.72	9EL 852 061-001	3.27				
9EL 134 740-001	2.72	9EL 852 820-001	3.27	9FH...			
9EL 134 741-021	2.72	9EL 854 912-001	3.27	9FH 093 887-001	1.66		
9EL 134 742-021	2.72	9EL 855 097-001	3.27				
9EL 135 060-001	2.135	9EL 856 010-001	2.240	9FT...			
9EL 135 266-001	2.113	9EL 856 415-001	3.26	9FT 087 771-001	2.219		
9EL 135 548-001	2.18	9EL 856 416-001	3.26-3.27	9FT 088 047-001	2.113-2.115		
9EL 136 819-011	2.33	9EL 856 416-011	3.27	9FT 117 109-007	2.208		
9EL 136 819-031	2.32	9EL 856 417-001	3.26	9FT 861 790-001	3.60		
9EL 136 819-041	2.34	9EL 856 418-001	3.26-3.27	9FT 861 790-011	3.60		
9EL 136 825-001	2.32	9EL 856 418-011	3.27	9FT 861 790-021	3.55		
9EL 136 825-011	2.32	9EL 856 989-001	3.62	9FT 861 790-031	3.55		
9EL 136 833-001	2.33	9EL 857 801-001	3.26	9FT 988 007-011	2.62, 2.308		
9EL 136 833-011	2.32	9EL 857 801-011	3.26				
9EL 137 241-001	2.165	9EL 857 803-001	3.26	9GD...			
9EL 137 307-001	2.72	9EL 859 020-001	3.04-3.05	9GD 023 639-001	1.69		
9EL 137 308-001	2.72	9EL 859 020-101	3.04-3.05	9GD 024 183-001	1.68-1.69		
9EL 137 792-011	2.33	9EL 859 658-001	3.18, 3.28	9GD 087 883-355	2.36, 2.285		
9EL 137 792-031	2.34	9EL 859 658-011	3.18, 3.28	9GD 100 140-001	2.168		
9EL 141 135-001	2.138	9EL 860 627-001	3.07-3.08	9GD 102 484-001	2.24, 2.32-2.34		
9EL 141 135-021	2.138	9EL 860 627-011	3.09	9GD 120 670-001	1.182		
9EL 141 135-031	2.138	9EL 860 628-021	3.07-3.09	9GD 157 876-007	2.148-2.150, 2.262, 2.268, 2.316		
9EL 141 612-001	2.195	9EL 861 498-001	3.57, 3.59				
9EL 146 491-001	2.55	9EL 861 498-011	3.57, 3.59	9GD 159 740-007	2.132		
9EL 146 838-001	2.08, 2.17, 2.188, 2.276-2.277, 2.286	9EL 861 912-001	3.56-3.58	9GD 159 820-007	2.215		
	2.08-2.09	9EL 861 912-011	3.59	9GD 175 947-001	3.73		
9EL 146 887-001	2.35	9EL 861 912-021	3.56-3.57	9GD 175 947-011	3.73		
9EL 147 096-001	2.35	9EL 861 912-041	3.59	9GD 175 947-021	3.73		
9EL 147 096-021	2.35	9EL 861 912-051	3.59	9GD 175 947-031	3.73		
9EL 147 096-031	2.35	9EL 861 913-001	3.56-3.58	9GD 175 947-041	3.73		
9EL 147 747-001	2.36, 2.285	9EL 861 913-021	3.56-3.57	9GD 175 947-051	3.73		
9EL 147 747-007	2.36	9EL 861 913-041	3.59	9GD 176 514-871	3.73		
9EL 147 910-001	2.142, 2.269	9EL 861 913-051	3.59	9GD 209 213-001	3.63-3.64, 3.67-3.70		
9EL 147 992-001	2.52	9EL 862 140-001	3.10-3.11	9GD 341 063-007	2.145-2.146, 2.264, 2.270, 2.317		
9EL 148 274-001	2.142, 2.264	9EL 86					



List of part numbers

Part number	Page	Part number	Page	Part number	Page	Part number	Page
9MN...							
9MN 854 290-001	3.12, 3.27						
9MN 858 114-001	3.04-3.05						
9MN 858 114-011	3.04-3.05						
9MN 858 616-001	3.26						
9MN 858 616-011	3.26						
9MN 860 677-001	3.07-3.09						
9MN 860 677-011	3.07-3.09						
9MN 860 677-021	3.07-3.09, 3.56-3.57						
9MN 862 741-001	3.04, 3.10-3.11, 3.13						
9MN 863 026-001	3.05-3.07						
9NB...							
9NB 201 024-042	1.46						
9NB 201 025-112	1.46						
9NB 201 026-112	1.46						
9NS...							
9NS 152 922-007	1.42-1.43						
9SG...							
9SG 998 005-002	1.191						
9SX...							
9SX 008 902-021	3.72, 3.74						
9SX 010 391-001	3.71						
9SX 010 391-011	3.71						
9SX 010 392-001	3.71						
9SX 010 393-801	3.71						
9SX 178 258-001	3.36						
9SX 863 114-001	3.72, 3.75						
9XB...							
9XB 136 202-005	2.244						
9XB 152 977-001	1.41-1.42						
9XB 161 749-007	2.74						
9XD...							
9XD 127 264-007	2.117						
9XD 130 261-001	1.85, 1.111-1.112, 1.119, 1.180-1.181, 1.190						
9XD 132 749-005	2.68						
9XD 160 867-007	2.155, 2.263						
9XD 161 119-007	2.85						
9XD 161 119-017	2.79-2.80						
9XD 177 162-801	3.73						
9XD 198 241-002	1.48-1.49						
9XD 254 226-007	1.44-1.47						
9XD 254 227-007	1.44-1.47						
9XD 344 118-101	2.234						
9XD 344 192-061	2.227-2.231						
9XD 344 192-071	2.227-2.231						
9XD 857 445-801	3.61						
9XD 861 990-001	3.61						
9XD 861 990-011	3.61						
9XD 861 990-021	3.61						
9XD 861 995-801	3.61						
9XD 863 533-001	3.33						
9XD 863 828-001	3.33						
9XD 990 298-001	1.95, 1.102, 1.106, 1.108-1.109, 1.129-1.130, 1.158, 1.164-1.165, 1.190						
9XD 990 298-031	1.90, 1.92-1.94, 1.100, 1.125-1.126, 1.128, 1.130, 1.142-1.146, 1.148, 1.159, 1.189						
9XD 990 308-001	1.42-1.43						
9XD 997 909-801	2.61-2.62, 2.89, 2.307-2.308, 2.311						
9XR...							
9XR 854 840-001	3.04, 3.09-3.11, 3.13, 3.26-3.27						
9XR 855 975-001	3.05-3.07, 3.54, 3.62						
9XS...							
9XS 027 639-001	1.185-1.186						
9XS 124 218-027	1.42-1.43						
9XS 124 218-037	1.40						
9XS 254 229-007	1.44, 1.46						
9XX...							
9XX 340 173-801	2.282						
9XX 340 220-001	2.336						
9XX 340 220-011	2.337						
9XX 340 220-021	2.336						
9XX 340 220-801	2.337						
9XX 340 222-001	2.285, 2.337						
9XX 340 223-001	2.337						
9XX 340 369-011	2.273						
9XX 340 870-007	2.337						
9XX 340 871-007	2.337						
9XX 340 872-007	2.337						
9XX 340 879-001	2.336						
9XX 340 880-001	2.336						
9XX 340 881-001	2.336						
9XX 340 882-001	2.336						
9XX 340 883-001	2.336						
9XX 340 884-001	2.336						
9XX 340 981-001	2.336						
9XX 340 984-001	2.336						



Manufacturer's no. / HELLA no.

Cross-Reference

Böckmann	HELLA	Bomag	HELLA	Bosch	HELLA	Bosch	HELLA
1061098	2PS 008 645-011	321 212 57	2JA 002 661-001	0 352 170 003	8JA 001 930-001	7 782 324 009	2RL 007 550-011
1063687	2KA 998 523-007	321 213 99	2JA 003 231-001	0 352 170 005	8JA 001 930-001	7 782 324 011	2RL 008 061-111
1063843	8KA 998 240-071	380 107 29	2JA 003 354-001	0 352 320 001	8JA 001 925-001	7 782 324 207	2RL 008 061-011
1063855	9GS 340 051-001	380 107 29	1GB 006 213-111	0 352 321 007	8JA 004 667-001	7 782 332 008	2RL 007 551-001
1064270	0HG 002 090-271	380 515 50	1GB 006 213-117	0 986 310 093	2AA 003 257-041	7 782 332 009	2RL 007 553-001
1067260	2ZR 997 506-391	380 515 50	2SD 002 582-011	0 986 310 093	2AA 003 257-042	7 782 332 011	2RL 008 060-101
1067996	2RL 008 064-101	380 515 50	2SD 002 582-017	0 986 310 526	1FB 007 560-311	7 782 332 209	2RL 008 060-001
1072466	2XT 008 929-001	380 515 51	2SD 002 582-021	1 300 312 025	9GT 067 751-001	7 782 334 007	2RL 007 551-011
1072466	2XT 008 929-007	380 515 51	2SD 002 582-027	1 300 508 024	9GH 116 966-011	7 782 334 007	2RL 007 551-011
1074194	2TM 008 645-921	380 515 52	2BM 006 692-011	1 300 508 034	9HD 121 297-035	7 782 334 008	2RL 007 553-011
1077681	8RA 004 412-021	380 515 52	2BM 006 692-017	1 300 630 034	9FF 085 642-001	7 782 334 009	2RL 008 060-111
1077682	8KA 004 412-001	380 515 53	2BM 006 692-021	1 300 636 140	9FF 126 444-001	7 782 334 207	2RL 008 060-011
1086777	8KA 340 845-031	380 515 53	2BM 006 692-027	1 304 485 004	8JA 001 909-001	7 782 362 008	2RL 008 065-101
1116499	2PS 009 226-807	380 515 54	1AB 006 213-001	1 304 485 900	8JA 001 909-001	7 782 362 008	2RL 008 065-101
1122345	2TM 008 645-941	380 515 58	2RL 007 551-001	1 305 311 050	9DR 060 567-001	7 782 362 207	2RL 008 065-001
1122345	2TM 008 645-947	380 516 61	8GJ 002 525-131	1 305 313 935	9DR 104 336-001	7 782 362 207	2RL 008 065-101
1123318	2PS 964 295-051	429 053 200	8GJ 002 525-136	1 305 320 816	1G8 132 233-011	7 782 364 007	2RL 008 065-101
1123482	8JD 008 151-051	429 095 021	8HG 002 365-001	1 305 543 911	9DF 112 246-001	7 782 364 207	2RL 008 065-111
Bomag	HELLA	429 095 021	1G4 003 470-141	1 305 601 082	9AG 104 328-001	7 782 372 003	2RL 007 552-001
055 801 56	8GA 006 841-121	429 095 021	1G4 003 470-147	1 305 601 905	9ES 015 675-001	7 782 372 004	2RL 008 062-101
055 801 56	8GA 006 841-123	H-41 488 73	2BA 002 324-021	1 305 601 909	9EL 101 353-001	7 782 372 004	2RL 008 062-001
057 109 3	2BE 003 014-251	H-41 493 31	1AA 004 109-031	1 305 620 468	9ES 106 588-001	7 782 372 204	2RL 007 552-011
057 109 3	2BE 003 014-257	H-606401006	2VP 006 040-121	1 305 620 468	9ES 120 743-001	7 782 374 005	2RL 008 062-111
057 510 21	8GP 002 066-241	H-606401006	2VP 006 040-127	1 305 620 971	9EL 123 632-001	7 782 374 006	2RL 008 062-111
057 510 26	H-606401011	H-606401016	2BE 002 582-031	1 305 621 072	9EL 123 635-001	7 782 374 203	2RL 008 062-011
057 510 45	2BE 001 259-061	U-3715947	1AE 004 234-001	1 307 337 018	8GS 007 949-261	7 782 430 030	1GS 001 523-021
057 510 49	2SW 003 014-131	U-41 488 72	2AA 001 200-131	1 307 337 019	8GS 007 001-151	8 780 556 000	9GH 096 532-001
057 510 54	8GH 002 089-133	U-4102141	2BA 002 324-011	1 315 620 909	9EL 092 435-011	8 785 510 065	9EL 856 418-011
057 510 54	8GH 002 089-136	U-4174391	2AA 001 200-041	1 315 620 957	9EL 109 139-001	8 785 510 071	9EL 852 820-001
057 510 78	2SA 003 014-051		2SW 003 014-131	1 315 620 960	9EL 107 368-001	8 785 510 073	9EL 855 997-001
057 510 84	2SE 002 578-701		Bosch	1 315 620 960	9EL 111 647-001	8 785 510 098	9EL 854 912-001
057 510 84	2SE 002 578-707		0 300 383 001	901 355 975	8KW 701 235-033	8 787 022 001	8HG 002 365-001
057 510 85	2SE 002 578-701		0 301 017 101	987 301 024	8GA 006 841-801	8 787 022 013	8HG 006 294-051
057 510 85	2SE 002 578-707		0 301 017 102	987 301 042	8GH 007 157-471	8 787 022 016	8HG 006 294-011
057 510 91	2ZR 002 985-081		0 301 017 303	987 302 015	8GH 002 089-141	8 787 510 023	9MN 860 677-001
057 510 93	2BE 003 014-251		0 301 019 100	987 302 031	8GH 002 090-133	8 787 510 023	8GH 002 089-251
057 510 93	2BE 003 014-257		0 301 019 101	987 302 035	8GH 002 090-371	8 787 510 023	8GH 002 089-253
057 510 95	1GD 003 590-701		0 301 203 001	987 302 041	8GJ 002 525-131	8 787 540 003	8GM 002 092-121
057 511 08	2BA 002 652-101		0 301 203 001	987 302 045	8GJ 002 525-361	8 797 022 002	2JA 003 231-001
057 511 08	2BA 002 652-107		0 301 204 001	987 302 071	8GH 007 157-121	8 797 337 026	2AA 001 200-131
057 511 16	9EL 115 003-011		0 301 204 002	987 302 071	8GH 007 157-126		2RL 008 062-001
057 511 29	9EL 115 003-055		0 301 204 101	987 302 075	8GH 007 157-181		2RL 008 062-011
057 511 41	9EL 118 700-001		0 301 302 101	987 302 081	8GH 008 356-121		2RL 008 062-101
057 511 42	9EL 118 703-001		0 301 302 102	987 302 082	8GH 008 357-001		2RL 008 062-111
057 511 44	9EL 118 705-001		0 301 302 102	987 302 084			
057 511 47	2AA 001 200-011		0 301 303 028	987 302 152			
057 511 48	2AA 001 200-021		0 301 303 032	987 302 153			
057 511 48	2AA 001 200-023		0 301 600 015	987 302 201			
057 511 52	1GA 005 060-337		0 301 600 110	987 302 202			
057 511 53	2SD 003 184-031		0 301 600 110	987 302 202			
057 511 53	2SD 003 184-037		0 301 600 804	987 302 204			
057 511 54	2SD 003 184-041		0 301 709 001	987 302 204			
057 511 54	2SD 003 184-047		0 301 709 100	987 302 206			
057 511 58	8RA 002 016-121		0 301 709 101	987 302 207			
057 511 59	8HG 002 240-031		0 305 406 901	987 302 207			
057 511 60	8RA 003 326-001		0 305 603 901	987 302 208			
057 511 63	8RA 003 326-002		0 306 055 101	987 302 209			
057 511 63	8GH 002 089-251		0 306 055 101	987 302 211			
057 511 64	8GH 002 089-253		0 306 407 001	987 302 212			
057 511 64	8HG 006 294-051		0 306 407 901	987 302 213			
057 511 69	8HG 002 240-001		0 306 481 004	987 302 214			
057 511 69	2ZR 003 014-091		0 306 481 004	987 302 215			
057 511 79	2JA 003 354-001		0 306 484 001	987 302 217			
057 511 79	8GH 007 157-121		0 306 484 001	987 302 220			
057 511 79	8GH 007 157-126		0 306 484 001	987 302 221			
057 511 80	8GS 007 949-261		0 306 484 001	987 302 222			
057 511 94	8GH 002 090-271		0 306 606 901	987 302 226			
057 511 95	1GM 996 134-091		0 310 152 006	987 302 229			
057 511 97	2BA 008 221-147		0 310 153 006	987 302 230			
057 511 98	2SA 008 405-021		0 310 153 004	987 302 231			
057 511 98	2SA 008 405-027		0 310 153 004	987 302 232			
057 512 00	8RA 003 326-031		0 311 109 001	987 302 238			
057 512 00	9EL 990 354-021		0 311 113 007	987 302 240			
057 512 26	1EB 996 167-031		0 311 113 007	987 302 241			
057 512 26	1EB 996 167-038		0 311 113 008	987 302 244			
057 512 27	1EB 996 167-041		0 311 113 008	987 302 245			
057 512 27	1EB 996 167-048		0 311 113 009	987 302 411			
057 512 31	2JA 343 606-011		0 311 113 009	987 302 411			
057 512 32	2JA 343 606-017		0 311 118 001	987 302 422			
057 512 32	2BE 343 130-667		0 311 118 002	987 302 431			
057 512 33	2BE 343 130-657		0 311 150 005	987 302 431			
057 512 34	2SD 343 130-747		0 311 316 004	987 302 442			
057 512 35	2SD 343 130-737		0 311 316 004	987 302 471			
057 512 36	1BA 996 261-021		0 311 424 004	987 302 501			
057 512 45	1GM 996 134-081		0 311 424 004	987 302 501			
057 512 55	2BA 003 014-111		0 311 424 006	987 302 503			
057 512 67	8GM 002 092-241		0 311 424 007	987 302 504			
057 512 68	8GA 002 073-241		0 311 424 007	987 302 505			
057 512 70	8GH 007 157-241		0 311 424 007	987 302 507			
057 512 71	2SD 343 130-147		0 311 424 007	987 302 508			
057 512 73	1GA 007 506-681		0 311 424 008	987 302 510			
057 512 79	1GA 996 189-001		0 311 424 008	987 302 511			
057 512 80	1GA 996 192-051		0 311 424 008	987 302 512			
057 512 83	2PF 008 405-061		0 311 424 009	987 302 512			
057 512 83	2PF 008 405-067		0 311 424 009	987 302 517			
057 512 84	1GD 996 193-051		0 311 424 010	987 302 518			
057 512 85	1GA 996 189-011		0 311 425 001	987 302 519			
057 512 89	1GD 996 193-051		0 311 425 001	987 302 519			
057 512 98	2BA 008 221-107		0 311 425 002	987 302 521			
057 551 67	2XS 950 071-031		0 311 425 003	987 302 522			
057 551 68	1GA 006 876-001		0 312 201 002				

Manufacturer's no. / HELLA no.

Cross-Reference



Bürstner	HELLA	Case IH	HELLA	Case IH	HELLA	Claas	HELLA
1712339	1N0 008 582-007	0 700255 5	8GA 002 071-123	3 223264 R91	2SD 002 776-241	001 069 90	2JA 001 357-002
1724446	8RA 003 326-041	0 700501 0	2BA 002 652-121	3 223264 R91	2SD 002 776-247	001 214 40	1G3 005 760-041
1724446	8RA 003 326-047	0 700501 0	2BA 002 652-127	3 229393 R1	2PF 003 014-071	001 236 10	1AB 006 213-001
200601014	2SA 003 236-341	0 700502 7	2BA 002 652-111	3 229394 R1	2SA 003 014-051	001 252 70	2SB 003 014-151
200601016	2BA 003 236-321	0 700502 7	2BA 002 652-117	3 233639 R1	9AG 104 328-001	001 310 70	6EB 005 633-001
200601017	2NE 003 236-301	0 703499 7	8GH 002 090-133	3 369718 R91	1GA 003 470-051	001 311 10	2BM 003 647-021
200601018	2PS 962 964-031	0 703499 7	8GH 002 090-136	3 404170 R93	1AA 004 109-001	001 327 70	9GH 993 984-001
200601018	2PS 962 964-037	0 706768 3	8GA 002 071-131	3 512768 M91	1GA 005 060-337	001 373 00	8GH 002 090-271
200601021	2KA 004 331-061	0 706768 3	8GA 002 071-133	3 523851 M91	1A3 002 850-031	001 373 10	1GB 996 080-021
200601023	2KA 004 331-067	0 706770 6	2SD 002 776-241	4 705 635 6	1GA 996 083-011	001 373 40	1EA 996 127-007
200601023	2VA 007 502-011	0 706770 6	2SD 002 776-247	4 705 635 7	1GA 996 083-011	001 373 40	1EA 996 127-007
200601023	2VA 007 502-017	0 706771 4	2SD 002 776-231	4 705 712 0	1GA 996 161-301	001 373 50	1GA 007 506-001
200601024	2VA 007 502-061	0 706771 4	2SD 002 776-237	4 705 712 5	1GA 996 161-301	001 373 50	1GA 007 506-002
200601025	2VP 007 502-127	0 706774 7	2KA 003 389-061	47056352	1GA 996 083-011	001 373 50	1GA 007 506-002
200601026	2VA 007 502-117	0 706774 7	2KA 003 389-062	470563520	1GA 996 083-011	001 375 90	1GA 007 506-061
200601027	2DA 008 136-017	0 706774 7	2KA 003 389-068	47056353	1GA 996 083-011	001 445 70	2SD 010 546-127
200601029	9GT 963 129-001	0 706917 0	8GA 002 071-251	470563530	1GA 996 083-011	001 446 10	4DW 009 492-111
200601046	2VA 341 419-011	0 707370 4	2XS 950 071-031	470563560	1GA 996 083-011	001 446 20	2SD 010 546-137
200601047	2VA 341 419-061	0 707374 5	8HG 006 294-051	470563570	1GA 996 083-011	001 478 90	2XS 955 232-001
200601048	2PG 964 295-011	0 707383 3	2VA 006 040-071	5 153085	1GA 006 875-001	001 478 91	2XS 955 232-017
200601048	2PG 964 295-017	0 707383 3	2VA 006 040-077	679 850 R91	2AA 001 200-011	001 486 40	1GA 998 522-011
200601054	2NE 008 221-137	0 707384 1	2VP 006 040-121	679 850 R91	2AA 001 200-012	001 488 00	8GS 009 028-111
200601055	2BA 008 221-147	0 707384 1	2VP 006 040-127	679 873 R91	2AA 001 200-021	001 488 10	5DV 008 855-001
200601056	2ZR 008 221-157	0 707387 4	8GJ 002 525-131	679 873 R91	2AA 001 200-023	001 488 10	5DV 008 855-007
200601057	2DA 008 221-167	0 707387 4	8GJ 002 525-136	7 024794	8GA 002 073-121	001 488 60	2BA 008 221-001
200601058	2SA 008 405-021	0 707481 8	2RL 006 846-001	7 15508R 92	8GA 002 073-123	001 488 60	2BA 008 221-007
200601058	2SA 008 405-027	0 707491 4	8JA 003 526-001	7 16160R 9	1G4 004 480-001	001 488 60	2BA 008 221-107
200601059	8XU 008 405-031	0 707517 7	8GM 002 091-131	7 16161R 1	9ES 012 060-011	001 488 70	2PF 008 221-011
200601059	8XU 008 405-037	0 707596 4	8JA 001 909-001	7 16161R 1	9GD 023 639-001	001 488 70	2PF 008 221-017
200601060	2PS 964 295-001	0 707657 1	1AB 007 145-001	7 16162R 2	9KS 075 139-001	001 488 70	2PF 008 221-177
200601060	2PS 964 295-007	0 707657 1	1AB 007 145-007	8 405980 9	1GA 007 506-101	001 489 30	1GA 996 083-011
200601061	2XS 008 479-091	0 707658 8	1GB 007 145-101	8 410 029 8	1GA 003 470-001	001 489 40	1GA 996 083-011
200601062	2XS 008 479-097	0 707658 8	1GB 007 145-107	8 422050 3	2BA 002 652-121	001 489 80	2SD 964 169-111
200601062	2XS 008 479-081	0 708103 7	2XS 005 020-077	8 422050 03	2BA 002 652-127	001 489 80	2SD 964 169-117
200601066	2KS 008 479-087	0 708901 1	8GP 002 095-241	8 455576 3	1GA 996 188-021	001 556 40	1GA 996 161-121
200601066	2VA 341 419-111	0 709011 0	8GH 002 089-131	8 481 446 8	1GB 006 213-111	001 556 90	1GL 008 090-201
200601066	2VA 341 419-117	0 709011 0	8GH 002 089-136	8 481 446 8	1GB 006 213-117	001 556 90	1GL 008 090-207
200601067	2VP 341 419-121	0 709038 5	1AB 006 213-011	8 481 446 9	1AB 006 213-011	001 586 00	1GA 998 522-407
200601067	2VP 341 419-127	0 709088 3	8JB 004 777-001	8 481 494 0	1GB 006 213-101	001 58630	1GA 996 461-547
200601068	1BL 008 193-001	0 709088 3	8JB 004 777-002	8 481 494 0	1GB 006 213-107	001 615 30	2SD 344 169-037
200601068	1BL 008 193-007	00 70249 87	8GA 002 073-241	8 731411 1	1GA 996 083-011	001 634 60	4DN 009 492-101
200601069	1K0 008 191-001	1 07484C 1	8RA 002 016-111	8 731411 2	1GA 996 083-011	001 664 50	1G3 996 176-131
200601069	1K0 008 191-007	1 07484C 1	8RA 002 016-111	8 737 460 1	1GA 996 161-101	001 664 50	1G3 996 176-137
200601071	6NM 007 282-221	1 089208 R91	1GA 003 470-031	8 752 189 0	1GA 996 161-061	001 673 10	9GH 158 051-007
200601074	2BM 008 771-001	1 094368 R1	8GA 002 071-121	9 200 196 21	1GA 996 161-121	001 684 50	9GT 134 655-007
200601074	2BM 008 771-007	1 094368 R1	8GA 002 071-123	9 25305C 92	2SD 001 680-281	001 689 60	5DV 008 856-001
200601081	2PF 003 563-151	1 20139A 1	1A3 005 760-501	9 25306C 92	2SE 001 680-291	001 689 60	5DV 008 856-007
200601081	2PF 003 563-177	1 20139A 1	1A3 005 760-507	9 28044C 1	8JA 001 909-011	001 689 70	2SB 964 169-531
200601084	2BM 006 692-011	1 312210 C2	8GH 002 090-371	9 440 199 32	1GA 998 522-011	001 689 70	2SB 964 169-537
200601084	2BM 006 692-017	1 328046 C1	1GA 004 480-001	9 802827 6	8GM 002 092-121	001 69020	2BA 964 169-501
200601085	2BM 006 692-021	1 333 291 C1	1AB 003 177-001	9 802909 6	1G3 005 760-221	001 69020	2BA 964 169-507
200601085	2BM 006 692-027	1 333292 C2	1VB 005 444-037	9 802909 6	1G3 005 760-227	001 720 70	2PF 006 717-011
200601089	8RA 343 220-017	1 34 672 4001	1GA 996 020-001	9 803274 4	1GD 003 690-287	001 723 50	2KA 010 278-321
200601093	2PG 964 295-121	1 346 724 00	1GA 996 020-001	9 803274 4	1AA 004 109-031	001 757 20	1GA 998 534-001
200601093	2PG 964 295-127	1 347760 10	9EL 118 614-011	9 803936 9	2TJ 001 633-211	001 758 00	8GS 007 949-261
200603004	8GP 003 594-121	1 40 172 0111	1GB 996 080-021	9 804137 1	2SB 003 014-151	00131111	2BM 003 647-067
200606017	8JA 007 158-001	1 40 179 021	1GA 998 522-011	9 804245 9	2KA 001 386-281	00143290	1NA 008 283-001
200923055	2PS 006 717-031	1 40 179 0031	1GA 998 522-011	9 804591 0	2RL 007 551-001	00144610	4DW 009 492-111
200923055	2PS 006 717-037	1 40 572 0011	1GA 996 083-011	9 804617 1	1GB 006 213-101	00144580	2BA 009 001-431
445151	2PS 002 727-001	1 40 572 0021	1GA 007 506-681	9 804669 9	1GB 006 213-107	00144600	9XD 161 119-017
445157	2SD 004 460-011	1 401 720 11	1GB 996 080-021	9 804669 9	9EL 136 825-011	00148880	1GL 008 090-201
445157	2SD 004 460-017	1 401 720 12	1GA 996 083-011	9 804669 9	9EL 136 825-001	00148880	1GL 008 090-207
445158	2SD 004 460-001	1 401 720 16	1GA 996 083-011	9 804750 6	9EL 860 627-001	00172360	1GD 996 193-001
445164	2KA 003 389-061	1 401 790 02	1GA 998 522-011	9 813 500	1GA 006 991-091	00172360	1GD 996 193-051
445164	2KA 003 389-062	1 401 790 03	1GA 998 522-011	9 961 9A1	9DX 859 626-001	00172370	1GA 995 193-001
445164	2KA 003 389-068	1 405 720 01	1GA 996 083-011	B 503 078	2SE 002 582-071	002 338 50	2BE 003 014-251
445166	2KA 001 378-127	1 405 720 02	1GA 007 506-681	E46821	1GA 998 522-011	002 338 50	2BE 003 014-257
445166	2KA 001 378-207	1 407722 12	1GA 998 525-001	G841783	1GA 998 522-011	006 642 10	2PF 003 014-071
445167	2XS 950 071-031	1 414469 0	8GD 002 078-121	H 40556	8GA 002 071-131	006 642 20	2SA 003 014-051
445177	2SD 006 040-131	1 414809 0	8GA 006 841-121	H 40556	8GA 002 071-133	007 463 20	1GA 998 522-011
445178	2SD 006 040-137	1 414809 0	8GA 006 841-123	K 965 604	2SD 001 693-011	007 752 00	2RL 006 846-001
445178	2SD 006 040-141	1 414819 0	8GA 002 073-121			007 752 10	8JB 850 434-011
445403	8RA 002 020-001	1 415159 0	8GH 002 090-133			007 752 20	9GH 096 532-001
445403	8RA 002 020-002	1 415159 0	8GH 002 090-136			007 772 20	2TM 006 717-047
445426	8RL 002 009-021	1 89124A 2	2PS 003 748-121			007 828 00	9GP 003 995-801
445427	8RA 003 326-001	1 89124A 2	2PS 003 748-127			013 712 10	2SE 002 514-171
445427	8RA 003 326-002	1 900034 52241	8GA 002 071-131			013 712 20	2SD 002 514-161
503108	2PG 003 057-011	1 900034 52241	8GA 002 071-133			013 712 30	9EL 119 614-031
		1 955175 C2	8GD 002 078-121			013 733 0	1GA 007 506-001
		1 983579 C1	1AB 008 888-051			013 733 0	1GA 007 506-002
		1 983579 C1	2KA 003 389-061			015 046 00	1GA 007 506-007
		1 983579 C1	2KA 003 389-062			015 046 10	9EL 340 829-011
		1 987 491 C2	2KA 003 389-068			015 046 10	9EL 340 829-001
		1-34-701-505	1GA 998 522-011			017 741 00	9EL 859 020-001
		1-34-701-505	2BE 003 014-251				



Manufacturer's no. / HELLA no.

Cross-Reference

Claas	HELLA	Claas	HELLA	DAF	HELLA	DAF	HELLA
031 806 20	2KA 003 389-061	140 786 90	1GA 995 506-001	086 7440	9DF 112 246-001	086 8230	2VP 008 204-101
031 806 20	2KA 003 389-062	140 786 91	1GA 995 506-001	086 7443	1AA 004 109-031	086 8288	2VD 007 323-131
031 806 20	2KA 003 389-068	181 283.20	1GA 996 661-001	086 7444	1G3 003 710-021	086 8289	2VD 007 323-141
031 832 20	2BN 964 169-051	2145	9GH 993 988-007	086 7445	1G4 003 470-051	086 8290	2VP 007 323-091
031 832 20	2BN 964 169-057	216 609.0	8GA 002 071-121	086 7446	1GA 006 876-001	086 8291	2VP 007 323-101
031 832 30	2BA 964 169-041	216 609.0	8GA 002 071-123	086 7447	1GA 006 991-021	086 8292	2PS 008 643-011
031 832 30	2BA 964 169-047	434 011 8	2JA 003 231-001	086 7448	1GA 006 991-041	086 8292	2PS 008 643-017
031 832 40	2TA 964 169-061	4-41002030250	2JA 002 661-001	086 7449	1GA 006 991-091	086 8293	2ZR 964 169-511
031 832 40	2TA 964 169-067	4-41004190120	2RL 008 061-111	086 7450	1GA 007 506-001	086 8293	2ZR 964 169-517
0310 4840	8RA 003 326-031	4-41004190324	8JA 001 909-001	086 7450	1GA 007 506-002	086 8295	2SD 964 169-411
041 592 10	9EL 854 912-001	4-41005031095	2JA 006 487-261	086 7450	1GA 007 506-007	086 8296	2NE 964 169-021
043 087 91	2JA 001 357-002	4-41008190050	2JA 003 354-001	086 7451	1GA 998 525-001	086 8296	2NE 964 169-027
048 899 90	1GA 996 188-001	4-43000000180	1G0 996 176-131	086 7452	1S3 001 117-041	087 1191	2PS 003 057-051
048 899 91	1GA 996 288-001	4-43000000180	1G0 996 176-137	086 7454	2BA 007 135-001	087 1191	2PS 003 057-057
049 714 00	2BE 343 130-081	4-46000000470	2JA 343 570-141	086 7455	2BM 006 692-021	087 1201	1GA 007 506-081
054 709 10	9XS 124 218-027	4-48000000230	2RL 008 061-101	086 7455	2BM 006 692-027	087 1215	2RL 007 900-001
057 097 51	1G4 003 470-051	4-48000001240	2JA 003 354-031	086 7456	2BM 009 320-807	087 1569	9XX 340 232-011
058 294 90	2BE 010 102-001	4-48000001250	2AB 001 208-001	086 7457	2JA 004 531-011	087 1599	9EL 115 830-001
058 368 00	1EA 993 975-011	4-48000001260	2JA 343 660-101	086 7458	2JA 007 372-001	087 8908	9EL 147 096-031
058 368 00	1EA 993 975-017	4-48000001260	2JA 343 660-107	086 7459	2KA 001 389-101	087 8909	9EL 147 096-021
058 368 10	1EA 993 975-021	4-48000001270	2JA 343 570-051	086 7461	2KA 003 389-001	087 8982	2PS 008 616-011
058 368 10	1EA 993 975-027	4-48000001280	2KA 343 700-271	086 7462	2KA 003 389-211	087 8982	2PS 008 616-017
058 489 90	2KA 003 738-057	4-49000004490	8KW 701 235-033	086 7462	2KA 003 389-217	087 8984	2XS 963 959-031
059 157 10	2BA 003 014-111	4-500 106 90	2JA 001 357-002	086 7463	2KA 340 118-001	087 8985	9EL 856 010-001
059 157 20	2SD 003 182-051	4-50077.521.0	8JA 850 434-011	086 7464	2NE 003 236-001	087 8995	2SA 003 734-121
059 157 30	2SD 003 182-057	4-500775220	9GH 096 532-001	086 7464	2NE 003 236-008	087 8996	2NE 003 734-091
059 157 30	2SD 003 182-061	4-50625.586.0	2JA 006 447-041	086 7468	2PG 003 057-011	087 8998	1F8 006 800-311
059 157 30	2SD 003 182-067	4-60000270000	2JA 003 231-001	086 7469	2PG 003 748-151	087 9047	9EL 136 819-031
059 157 40	8RA 003 326-001	4-60000280000	1GA 005 060-001	086 7470	2PG 962 964-041	087 9082	2SE 997 008-001
059 157 40	8RA 003 326-002	501 003 2	2JA 004 531-001	086 7472	2PS 003 748-121	087 9085	9EL 997 332-001
059 197 30	9EL 110 536-001	551	8JA 003 526-001	086 7472	2PS 003 748-127	087 9100	2ZR 005 860-151
059 197 40	9EL 118 614-011	6-27906100020	8KA 002 071-251	086 7473	2PS 003 748-161	087 9101	2ZR 997 506-391
059 510 10	2KA 001 386-231	695 403 0	2KA 001 386-281	086 7473	2PS 003 748-167	087 9102	2ZR 005 700-191
059 538 50	8JA 001 909-001	817 623 8	2JA 001 364-001	086 7474	2PS 006 717-067	087 9123	1F8 007 560-301
059 758 90	1AB 996 157-091	836 254 0	2BA 003 014-011	086 7474	2PS 006 717-067	087 9124	1F8 007 560-321
059 846 10	2ZR 964 169-031	875 059 030353	2SD 002 582-011	086 7475	2PS 007 872-011	087 9125	1F8 006 800-321
059 846 10	2ZR 964 169-037	875 059 030353	2SD 002 582-017	086 7475	2PS 007 972-017	087 9143	9EL 134 296-051
059 879 80	1AB 996 157-081	875 059 030354	2SD 002 582-021	086 7476	2PS 008 382-001	087 9144	9EL 134 296-041
059 942 80	1AB 996 157-131	875 059 030354	2SD 002 582-027	086 7476	2PS 008 382-007	087 9145	2SA 005 603-021
060 405 30	2BM 002 652-031	908 430 301	2JA 003 232-001	086 7477	2PS 008 382-811	087 9145	2SA 005 603-027
060 605 30	2BM 002 652-031	940 350 0	9EL 950 315-001	086 7477	2PS 008 382-817	087 9147	9EL 119 614-031
062 228 60	2JA 006 447-041	940 351 0	9EL 950 315-031	086 7479	2PS 008 643-031	087 9156	1FE 006 300-001
062 289 80	2BE 003 347-001	968 997 0	2SE 004 623-001	086 7479	2PS 008 643-037	087 9183	2VA 004 887-031
062 290 70	1AE 003 427-011	968 997 0	2SE 004 623-007	086 7481	2RL 007 337-001	087 9122	1F8 007 560-311
062 438 72	2SA 001 259-751			086 7482	2RL 008 060-111	088 0195	2VP 007 500-421
062 438 72	2SA 001 259-757			086 7483	2SB 003 014-151	088 0196	2VD 007 500-411
062 455 90	2BE 001 259-061	006 6613	9DS 121 707-001	086 7484	2SD 001 680-271	088 0215	2XA 959 560-401
062 456 00	2SB 001 259-261	006 6614	6ED 708 919-001	086 7485	2SD 001 680-281	088 0215	2XA 959 560-407
062 558 60	2JA 006 447-041	006 7392	2XS 950 071-031	086 7486	2SD 003 184-031	088 0216	2XA 959 790-401
062 571 90	1GB 006 213-111	008 0796	1A7 003 099-011	086 7486	2SD 003 184-037	088 0216	2XA 959 790-407
062 571 90	1GB 006 213-117	008 191047	1K0 008 191-041	086 7487	2SD 003 184-041	088 1373	2ZR 003 734-041
062 591 40	1GB 006 213-101	008 191047	1K0 008 191-047	086 7487	2SD 003 184-047	088 1374	2DA 003 734-011
062 591 40	1GB 006 213-107	008 3764	2AB 004 532-051	086 7488	2SE 001 685-221	088 1375	2BA 003 734-001
064 398 00	2XS 005 020-021	008 3764	2AB 004 532-057	086 7488	2SE 001 685-227	088 2004	2VD 007 500-201
065 817 70	2SW 003 185-041	008 582017	1N0 008 582-011	086 7489	2SE 002 578-701	088 2009	8GS 007 949-261
065 817 70	2SW 003 185-047	008 582017	1N0 008 582-017	086 7489	2SE 002 578-707	088 2011	2SE 003 167-031
065 828 40	1S0 001 430-011	011 9033	8GA 002 071-241	086 7490	2SE 007 547-041	088 2012	2SD 003 167-021
065 829 50	1G3 005 760-001	017 3732	2PF 001 647-031	086 7491	2SK 340 101-001	088 2013	2JA 003 354-051
065 840 30	2KA 001 386-281	017 3732	2PF 001 647-037	086 7492	2SK 340 101-011	088 2014	2PS 007 943-321
067 144 00	8RA 002 016-111	017 6043	8GA 002 073-241	086 7493	2TM 003 748-011	088 2062	2VP 340 400-121
068 225 80	2BA 001 277-021	027 3336	1G4 003 470-031	086 7498	2VB 007 547-171	088 2063	2VP 340 400-131
068 225 90	2BA 001 277-011	029 9634	2BA 001 416-011	086 7499	2VD 008 205-011	088 2064	9EL 117 330-011
073 639 60	9GH 126 647-011	029 9635	2BA 001 416-021	086 7500	2VD 008 205-021	088 2065	9EL 117 334-021
075 107 10	2SD 003 167-011	046 7569	9EL 146 491-001	086 7502	2VP 340 450-021	088 2083	8RA 004 412-001
075 107 30	2SD 003 167-021	053 2655	2SE 001 688-151	086 7503	2XA 959 790-411	088 2084	8RA 004 412-011
07946400	2KA 003 389-061	053 4597	8GA 002 071-251	086 7504	2XS 005 020-001	088 2085	8RA 004 412-021
07946400	2KA 003 389-062	055 2953	8HG 002 365-001	086 7504	2XS 005 020-002	088 2235	2BA 008 260-001
07946400	2KA 003 389-068	055 7060	2BA 003 014-111	086 7504	2XS 005 020-003	088 2235	2BA 008 260-007
081 969 81	8RW 341 235-007	055 7096	2KA 001 378-041	086 7505	2XS 008 078-001	088 2236	1NE 008 773-031
083 529 40	2PF 003 563-177	056 0333	2PF 001 259-631	086 7505	2XS 008 078-007	088 2331	2VD 003 567-371
091 730 10	1G5 003 241-071	056 3047	2SE 001 685-201	086 7506	2XS 955 031-001	088 7342	9XD 863 828-001
092 959 20	8JA 001 914-011	056 3048	2SD 001 685-211	086 7513	4RA 965 400-001	088 7343	2RL 007 017-071
094 079 70	9EL 136 833-001	056 3048	2SD 001 685-218	086 7520	6ED 004 778-001	088 7349	2VP 340 400-141
094 576 20	2PF 001 634-101	057 4235	2PF 001 648-171	086 7526	8GH 002 089-361	088 7349	2VP 340 400-147
094 576 40	2SD 002 776-241	0614367	2ZR 001 423-001	086 7527	8HG 006 294-021	088 7350	2VP 340 400-151
094 576 40	2SD 002 776-247	062 1969	8JA 001 915-001	086 7528	8JA 001 909-011	088 7350	2VP 340 400-157
094 576 60	2SE 002 776-211	063 3406	9GH 096 532-001	086 7539	8JE 340 060-011	088 7639	1F8 009 797-121
094 576 60	2SE 002 776-217	064 1800	2JA 003 231-001	086 7549	8RA 002 016-121	088 7640	1F8 006 800-341
096 899 80	2SD 004 623-028	067 6003	2JA 003 354-001	086 7550	8RA 003 326-031	088 7685	2BA 964 169-501
096 978 50	2XS 950 071-031	069 2279	9EL 101 353-001	086 7551	8RA 003 326-051	088 7685	2BA 964 169-507
096 989 70	2SE 004 623-001	069 2421	2XW 003 146-001	086 7553	8RA 964 292-001	088 8487	9EL 862 141-021
096 989 70	2SE 004 623-007	069 2705	9ES 106 588-001	086 7557	9BG 121 587-031	088 8498	2VP 340 930-011
097 025 50	2SD 006 040-161	069 4231	1G5 003 241-081	086 7557	9BG 121 587-037	088 8499	2VP 340 930-001
097 025 50	2SD 006 040-167	069 6363	9EL 120 240-011	086 7558	9EL 107 368-001	088 8500	9EL 340 829-031
097 025 60	2SE 006 040-011	069 8807	9EL 110 737-001	086 7559	9EL 111 647-001	088 8501	9EL 340 829-021
100 221 40	1BL 008 193-011	069 8808	9EL 110 736-001	086 7560	9EL 117 334-001	088 8539	1FE 008 773-001
100 221 40	1BL 008 193-017	070 2462	2SD 001 688-141	086 7561	9EL 118 700-001	088 8540	1GM 996 136-131
100 221 45	8GH 007 157-241	075 5355	2AB 004 532-051	086 7562	9EL 118 701-001	088 8541	1FE 006 300-041
100 221 46	2BA 008 221-001	075 5355	2AB 004 532-057	086 7563	9EL 119 544-021	088 8549	1FE 008 773-081
100 221 46	2BA 008 221-007	078 9					

Manufacturer's no. / HELLA no.

Cross-Reference



DAF	HELLA	DAF	HELLA	DAF	HELLA	DAF	HELLA
090 6470	1DL 007 872-037	090 6628	2XS 340 827-121	130 2727	2PS 006 717-037	137 8137	2PS 962 964-018
090 6471	1DL 007 872-047	090 6631	2ZR 965 039-121	130 2728	2PS 006 717-061	138 2999	2KA 001 386-231
090 6472	1DL 007 872-077	090 6631	2ZR 965 039-127	130 2728	2PS 006 717-067	138 3020	1NE 006 300-051
090 6473	1DL 007 872-087	090 6632	2ZR 996 179-701	130 2729	9EL 141 135-031	139 1259	2SA 001 259-751
090 6474	1E3 996 160-637	090 6633	2ZR 996 506-501	130 4073	2ZR 003 315-041	139 1259	2SA 001 259-757
090 6475	1E3 996 160-647	090 6636	9DR 104 336-001	130 4095	9EL 132 404-001	139 4332	8XS 147 945-001
090 6476	1E3 996 160-671	090 6639	9EL 119 544-001	130 4096	9EL 132 403-001	139 9200	2NE 003 315-011
090 6477	1E3 996 160-681	090 6640	9EL 119 544-111	131 12220	2XW 007 146-011	139 9392	9EL 119 977-001
090 6478	1EB 996 167-177	090 6641	9EL 132 215-001	131 7460	1H3 002 456-032	139 9393	2ZR 003 315-041
090 6479	1EB 996 167-187	090 6642	9GD 807 883-355	133 5901	1GA 007 506-011	142 7048	2PF 003 057-041
090 6485	1G4 003 470-141	090 6643	9GD 102 484-001	133 5901	1GA 007 506-012	142 7049	2SA 003 057-021
090 6485	1G4 003 470-147	090 6644	9GT 074 132-001	133 6853	2RL 007 550-011	142 7050	2PF 001 648-161
090 6486	1G4 003 470-141	090 6645	9GT 143 133-007	134 1734	1G4 003 470-031	142 7051	2BA 003 014-111
090 6486	1G4 003 470-147	090 6646	9NM 858 114-011	134 4984	2PF 001 259-631	142 7052	1F8 006 800-221
090 6487	1GA 007 506-431	090 6648	9XD 130 261-001	134 6293	8HG 006 294-011	142 7053	2SD 001 699-061
090 6488	1GA 007 506-681	090 6649	9XX 340 173-801	135 0426	2PS 007 943-011	142 7054	2SD 001 699-511
090 6491	1GA 996 161-581	090 6673	2XS 005 020-011	135 0426	2PS 007 943-017	142 7058	2KA 997 011-021
090 6492	1GA 996 179-001	090 6673	2XS 005 020-017	135 0427	2PS 007 943-021	142 7059	9EL 109 139-001
090 6493	1GA 996 361-011	090 6792	2ZR 003 236-051	135 0427	2PS 007 943-027	142 7061	9EL 117 330-001
090 6494	1GA 996 361-171	090 6792	2ZR 003 236-057	135 3664	8JB 850 434-011	142 7062	9EL 108 435-001
090 6495	1GA 997 506-157	090 6794	2RL 008 183-101	135 3665	9GH 096 532-001	142 7063	9EL 135 266-001
090 6496	1GA 997 506-557	090 7333	9EL 990 633-031	135 4854	8GP 003 594-121	142 7064	9EL 109 208-011
090 6497	1GL 008 090-211	090 7334	9EL 990 633-041	135 4855	8GP 002 095-241	143 5116	2KA 001 386-281
090 6497	1GL 008 090-217	090 7335	4RD 933 332-061	135 4856	8GM 002 091-121	143 5134	9EL 122 689-021
090 6499	1HS 998 502-051	090 7365	2PS 008 645-991	135 4857	8GM 002 091-241	143 5318	8JB 001 933-031
090 6500	1NO 009 295-057	090 7385	9NM 862 741-001	135 4858	8GH 002 089-133	143 5321	9XD 857 445-801
090 6501	1NO 009 295-067	090 7573	2PF 959 590-212	135 4858	8GH 002 089-136	143 5326	8HG 006 294-051
090 6502	1NL 008 090-117	090 7573	2PF 959 590-218	135 4860	8GH 002 857-241	144 5327	9GT 963 129-001
090 6504	2BA 965 039-101	090 7573	2PF 959 590-218	135 4861	8GP 003 594-141	144 1064	1G3 996 001-271
090 6504	2BA 965 039-107	090 7574	2PF 959 590-202	135 4862	8GM 002 092-121	144 3100	1F8 007 560-041
090 6505	2BA 965 039-141	090 7574	2PF 959 590-207	135 4863	8GM 002 092-241	144 4311	1F8 007 560-561
090 6505	2BA 965 039-147	090 7580	8KB 990 299-001	135 4864	8GM 002 091-131	144 4312	1F8 007 560-571
090 6506	2BA 965 039-091	090 7596	2XS 005 020-011	135 4865	8GA 002 071-121	145 0612	2JA 007 373-071
090 6507	2KA 005 049-011	090 7596	2XS 005 020-017	135 4865	8GA 002 071-123	145 1777	9GD 858 086-001
090 6508	2KA 340 828-001	090 7635	2PF 959 570-202	135 4866	8GA 002 071-241	148 7290	2SK 003 567-661
090 6512	2NE 965 039-111	090 7635	2PF 959 570-207	135 4867	8GP 002 068-121	148 7291	2SK 003 567-651
090 6512	2NE 965 039-117	090 7750	1GA 996 242-111	135 4868	8GP 002 066-121	148 7327	9EL 860 627-001
090 6513	2PF 003 563-187	090 7781	9NM 858 114-001	135 4869	8GP 002 068-241	148 7446	2BE 003 184-061
090 6514	2PF 008 221-011	090 7784	2NE 959 011-501	135 4870	8GP 002 095-121	148 9041	2BE 003 184-051
090 6514	2PF 008 221-017	090 7878	9DX 860 438-001	135 4871	8GA 002 073-121	148 9286	2KA 004 525-001
090 6515	2PF 008 221-017	090 7879	2VP 003 567-111	135 4871	8GA 002 073-123	148 9727	2PG 964 295-111
090 6515	2PF 340 000-111	090 7880	2VP 003 567-121	135 4872	8GA 002 073-241	148 9727	2PG 964 295-117
090 6516	2PF 962 964-071	090 7880	2VP 003 567-127	135 4873	8GP 003 594-241	148 9728	1ND 005 700-841
090 6517	2PF 965 039-151	090 7949	9AG 141 819-011	135 4875	8GP 002 067-121	151 7076	1F1 009 094-051
090 6519	2PG 340 000-121	090 7950	2SD 006 040-031	135 4875	8GP 002 067-123	152 6141	2RL 007 900-201
090 6520	2PS 340 000-001	090 7950	2SD 006 040-037	135 4877	8GP 002 067-241	152 1141	2VR 006 040-301
090 6521	2PS 340 000-011	090 8060	2VP 340 961-211	135 4878	8GD 002 078-121	152 1141	2VP 006 040-307
090 6522	2PS 340 000-021	090 8061	2VP 340 961-221	135 4879	8GD 002 078-241	152 2232	2VP 008 204-181
090 6523	2PS 340 000-041	090 8130	2RL 010 979-001	135 4880	8GP 002 068-241	152 2243	2SD 003 182-051
090 6524	2PS 340 000-051	090 8131	2RL 010 979-011	135 4881	8GM 002 091-251	152 2243	2SD 003 182-057
090 6526	2PS 340 000-171	090 8458	1FA 008 283-011	135 4882	8GH 002 090-133	152 2278	2VD 008 204-191
090 6533	2RL 006 846-111	090 8461	2XS 011 744-111	135 4882	8GH 002 090-136	152 2386	2VD 008 204-091
090 6534	2RL 007 017-051	090 8462	2XS 011 744-101	135 4883	8GH 002 090-251	152 2387	2VP 008 204-081
090 6537	2RL 007 337-041	090 8463	2XS 011 744-031	135 4883	8GH 002 090-253	152 3548	2VP 006 040-121
090 6538	2RL 007 337-057	090 8477	2VP 007 323-011	135 4884	8GA 002 071-131	152 3548	2VP 006 040-127
090 6539	2RL 007 337-111	090 8478	2VP 007 323-021	135 4884	8GA 002 071-133	152 3987	1F3 009 094-031
090 6541	2RL 007 551-011	090 8490	2RL 011 484-001	135 4885	8GA 002 071-251	152 4085	9EL 147 097-001
090 6542	2RL 007 552-011	090 8959	2DA 343 106-011	135 4886	8GA 002 072-241	152 4090	2VD 005 300-551
090 6543	2RL 007 553-011	090 9105	2DA 343 106-017	135 4887	8GH 002 089-251	152 4091	2VD 005 300-581
090 6544	2RL 008 060-011	0906 536	2RL 007 337-031	135 4887	8GH 002 089-253	152 4092	9EL 134 301-011
090 6545	2RL 008 061-011	091 0344	9XX 340 882-001	135 4888	8GJ 002 525-131	152 4097	2SB 009 362-011
090 6546	2RL 008 062-011	091 0345	9XX 340 883-001	135 4888	8GJ 002 525-136	152 4100	2BA 009 001-107
090 6547	2RL 008 062-111	091 0346	9XX 340 884-001	135 4889	8GJ 002 525-251	152 4101	2ZR 009 001-011
090 6548	2RL 008 063-011	091 0347	9XX 340 879-001	135 4890	8GM 002 094-241	152 4101	2ZR 009 001-017
090 6549	2RL 008 063-111	091 0348	9XX 340 880-001	135 4893	8GJ 002 525-281	152 4102	2SA 008 405-011
090 6550	2RL 008 065-011	091 0349	9XX 340 881-001	135 4894	8GA 002 071-271	152 4102	2SA 008 405-017
090 6551	2RL 008 065-111	091 0355	2VA 006 040-071	135 4895	8GA 002 071-261	152 4337	2SK 005 883-011
090 6552	2RL 008 181-011	091 0355	2VA 006 040-077	135 4896	8GP 002 067-261	152 4392	2BA 008 221-001
090 6554	2RL 008 182-011	091 1021	2SB 001 423-097	135 7075	2VD 008 204-251	152 4392	2BA 008 221-007
090 6555	2RL 008 182-111	091 1598	2BA 996 012-071	135 7076	2VP 008 204-241	152 4393	2ZR 008 221-051
090 6556	2RL 008 183-011	091 1599	9EL 990 034-041	135 7426	2BA 007 135-011	152 4393	2ZR 008 221-057
090 6558	2TM 008 645-941	091 1701	2XS 011 744-161	135 8193	2XS 955 232-001	152 4394	2XA 008 221-021
090 6558	2TM 008 645-947	091 1702	2XS 011 744-171	135 8201	8KA 962 886-001	152 4394	2XA 008 221-027
090 6559	2RL 008 965-011	091 1703	2XS 011 744-081	135 8320	8HG 006 294-041	152 4395	2SB 008 405-091
090 6562	2RL 008 967-011	091 1704	2XS 011 744-071	135 8321	8HG 006 294-021	152 4396	1FA 008 284-011
090 6563	2RL 008 967-041	091 1710	8HG 340 489-001	135 8779	2RL 006 846-001	152 4399	8HG 160 409-002
090 6566	2SA 965 039-081	091 1721	2SD 344 100-001	135 8780	2RL 006 846-011	152 4400	2PS 008 645-601
090 6566	2SA 965 039-087	091 17212	2SD 344 100-001	135 8781	9EL 859 020-001	152 4400	2PS 008 645-607
090 6567	2SB 965 039-131	091 17222	2SD 344 100-101	135 8782	9EL 950 315-061	152 4401	1GM 996 134-171
090 6567	2SB 965 039-137	091 2460	8KL 340 412-001	135 8783	9EL 950 315-001	152 4403	2NE 008 221-031
090 6569	2SD 343 130-227	091 2461	9EL 136 819-011	135 8784	9EL 950 315-031	152 4403	2XA 008 221-037
090 6570	2SD 343 130-337	091 2462	9EL 137 792-011	135 8786	2VP 007 907-031	152 4404	2XA 008 221-021
090 6571	2SD 343 130-397	1 526 765	2SD 001 693-011	135 8786	2VP 007 907-037	152 4404	2XA 008 221-027
090 6573	2SK 340 101-031	121 2109	1FD 005 700-051	135 8787	2VP 007 907-041	152 4405	8KA 152 134-007
090 6577	2VA 343 640-111	121 2111	1ND 005 700-061	135 8787	2VP 007 907-047	152 4430	2PT 009 496-801
090 6578	2VA 343 640-207	121 2113	1FD 135 198-011	135 8788	9EL 150 965-001	152 4432	8XU 009 362-111
090 6579	2VB 343 640-297	121 2115	1ND 136 933-011	135 8789	9EL 150 966-001	152 4433	8XU 009 362-101
090 6582	2VP 006 040-397	121 2127	2TJ 001 633-211	135 8790	2KA 007 929-001	152 4434	9HB 163 085-012
090 6583	2VP 006 040-407	122 6138	8JA 003 526-001	135 8790	2KA 007 929-007	152 4435	9HB 161 112-012
090 6585	2VP 340 450-141	123 0972	2PF 001 647-031	135 8791	2XS 955 260-001	152 4449	9XD 161 119-007
090 6586	2VP 340 450-151	123 0972	2PF 001 647-037	135 8791	2XS 955 260-007	152 4450	8JD 156 150-807
090 6587	2VP 340 450-441	125 01					



Manufacturer's no. / HELLA no.

Cross-Reference

DAF	HELLA	DAF	HELLA	DAF	HELLA	Demag	HELLA
152 6159	9EL 136 825-011	152 9493	2BA 011 172-421	152 9626	2DA 343 106-211	05830540	2AA 001 200-011
152 6168	2VP 006 040-111	152 9494	2BA 011 172-431	152 9627	2DA 343 106-231	05830540	2AA 001 200-012
152 6168	2VP 006 040-117	152 9495	2BA 343 390-071	152 9628	2DA 343 800-047	05831040	2AA 001 200-151
152 6256	2VP 340 931-001	152 9496	2BA 344 200-037	152 9629	2DA 959 071-237	05833240	2PF 001 259-631
152 6257	2VP 340 931-011	152 9497	2BA 344 200-341	152 9630	2DA 959 071-737	05834340	2SA 001 259-751
152 6258	1TA 003 570-001	152 9498	2BA 959 011-301	152 9977	2SL 003 567-691	05834340	2SA 001 259-757
152 6341	2BA 002 324-001	152 9499	2BA 959 822-601	1526763	2SE 001 680-301	05835540	9XS 027 639-001
152 6360	9EL 115 003-055	152 9500	2BA 964 169-311	1529 577	2VP 340 961-141	058380	2JA 003 232-001
152 6377	2VA 343 640-071	152 9501	2BA 980 607-201	1529558	2SD 959 050-401	05838040	2JA 003 232-011
152 6377	2VA 343 640-077	152 9502	2BA 980 607-701	153 3600	9DW 196 483-001	0870693	1G3 996 001-301
152 6378	2VP 343 640-021	152 9503	2DA 011 172-461	153 36000	9DW 196 483-001	0870693	1G4 003 470-051
152 6378	2VP 343 640-027	152 9504	2PF 009 514-001	153 3685	2RL 011 484-011	0882340	1F8 003 168-021
152 6447	2KA 010 278-011	152 9505	2PF 009 514-011	153 6974	2JA 004 531-001	11481912	2KA 007 560-571
152 6447	2KA 010 278-021	152 9508	2TM 008 645-661	161 6169	2RL 008 061-101	12592299	8GA 002 083-251
152 6495	2PS 008 645-301	152 9509	2KA 959 295-091	162 2273	1F8 007 560-131	14956440	2AA 001 200-031
152 6522	1NE 138 555-011	152 9510	2XA 959 560-417	162 2671	2SL 003 567-311	15884540	8GH 002 090-251
152 6681	9EL 340 829-011	152 9510	2XA 959 560-417	162 3563	1FE 002 537-191	15884540	8GH 002 090-253
152 6686	2VP 340 942-101	152 9511	1F3 009 094-031	162 3564	2ZR 001 193-011	15884540	8GH 002 090-258
152 6686	2VP 340 942-111	152 9512	1F1 009 094-041	162 4964	2KA 006 896-001	159 937 40	2AA 001 200-031
152 6687	2VP 340 942-101	152 9513	1F1 009 094-091	162 4964	2KA 006 896-007	15993340	2AA 001 200-131
152 6687	2VP 340 942-111	152 9515	1F3 009 094-021	162 5985	2VD 008 204-251	17419312	1GA 007 506-391
152 6687	2VP 340 942-111	152 9516	1F3 009 094-061	162 5986	2VP 008 204-241	18015040	2SE 002 578-701
152 6688	9EL 340 829-051	152 9517	1F3 009 094-071	163 6919	5DV 008 856-001	18015040	2SE 002 578-707
152 6716	5DS 009 552-011	152 9518	1F3 010 119-001	163 6919	5DV 008 856-007	18015040/41485440	2SE 002 578-701
152 6764	2SE 001 680-291	152 9519	1F3 010 119-011	163 7337	8GH 007 157-121	18015040/41485440	2SE 002 578-707
152 6858	1GA 996 142-011	152 9520	1F3 010 119-021	163 7337	8GH 007 157-126	18015240	2BA 003 014-111
152 6897	4RA 003 530-051	152 9521	1F8 007 560-731	163 7338	8GH 007 157-241	18085740	2BA 002 324-001
152 6898	1F8 162 870-101	152 9522	1F8 007 560-331	164 4059	2RL 008 061-111	18085940	8RL 002 009-021
152 6903	2PF 004 081-107	152 9523	1F8 007 560-401	164 4059	1F8 007 560-211	18089740	2SB 003 014-151
152 6949	2XD 010 311-001	152 9524	1F8 007 560-411	165 984	9EL 102 240-031	19648940	2SD 003 167-021
152 6974	2JA 004 531-001	152 9525	1F8 007 560-421	166 0613	9GD 863 033-001	19649040	2SE 003 167-031
152 7006	1G0 996 176-001	152 9526	1F8 009 797-101	167 1839	2XT 009 098-011	19679740	2SD 001 699-061
152 7006	1G0 996 176-002	152 9527	1F8 009 797-111	168 3694	1GA 007 506-021	19932512	2VP 340 888-011
152 7006	1G0 996 176-007	152 9528	1F8 009 797-121	169 3695	1F8 006 800-401	19932512	2VP 340 888-017
152 7012	2SK 340 101-021	152 9529	1F8 009 797-321	169 4027	8JD 008 151-011	19932612	2VP 340 888-001
152 7013	2VB 004 887-011	152 9530	1F8 009 797-331	169 9849	1F8 007 560-201	20882340	2VP 340 888-007
152 7014	2VP 004 887-021	152 9531	1F8 009 797-351	169 9435	9EL 862 141-001	20882340	2KA 003 168-021
152 7113	2BA 009 204-051	152 9532	1F8 009 797-421	173 1959	2PS 008 645-001	22444312	8JA 003 526-001
152 7113	2BA 009 204-057	152 9533	1FE 008 773-011	173 1959	2PS 008 645-007	22581012	1GA 007 506-491
152 7115	8KA 340 822-071	152 9534	2VP 340 942-001	173 5534	8GS 861 955-021	23114112	2ZR 002 694-001
152 7131	2PG 003 057-061	152 9535	2VP 340 942-011	185 3599	1A7 003 099-011	23246012	9EL 122 689-021
152 7131	2PG 003 057-067	152 9536	2VP 340 932-001	187 0850	8GS 861 955-021	23435140	8GH 002 240-031
152 7148	2PS 008 645-187	152 9537	2VP 340 932-011	187 1834	2PS 008 645-891	23463940	8GH 002 090-251
152 7149	9EL 340 208-021	152 9538	2VP 340 934-101	192 2467	2PS 345 600-071	23463940	8GH 002 090-253
152 7150	2VD 007 323-031	152 9539	2VP 340 934-111	192 2467	2PS 345 600-077	23463940	8GH 002 090-258
152 7151	2VD 007 323-041	152 9540	2SA 011 172-441	196 1901	9EL 183 432-001	24090712	2XW 007 146-001
152 7152	9EL 146 887-001	152 9542	2SB 343 390-091	196 2467	2PS 345 600-071	24429240	8GH 002 240-021
152 7178	1F8 007 560-631	152 9543	2SB 959 010-301	196 2467	2PS 345 600-077	25003540	8JA 001 909-011
152 7179	1FE 008 773-051	152 9544	2SB 959 821-601	196 2482	2PS 345 600-011	25003540	8JA 001 909-001
152 7180	2XS 340 827-131	152 9545	2SB 964 169-301	196 2482	2PS 345 600-017	25003540	8JA 001 909-011
152 7181	2XS 340 447-001	152 9546	2SB 980 606-201	196 2616	2TM 345 600-311	25505040	2XS 003 168-071
152 7200	2VP 340 940-101	152 9547	2SB 980 606-701	196 2616	2TM 345 600-317	25519040	2XS 005 020-011
152 7201	2VP 340 940-111	152 9548	2SD 343 390-011	196 2664	2PG 345 600-401	25519040	2XS 005 020-017
152 7224	2PT 010 458-801	152 9549	2SD 343 390-401	196 2665	2PS 345 600-021	25549140	2AA 001 200-041
152 7225	2PT 010 458-811	152 9549	2SD 343 390-407	196 2666	2PS 345 600-041	25561940	1A3 005 760-511
152 7226	2PT 010 458-821	152 9550	2SD 343 910-001	196 3100	2PS 345 600-197	25643240	2SD 003 167-011
152 7227	2PT 010 458-831	152 9551	2SD 343 910-017	1981861	2VP 012 381-221	25695440	8RA 003 326-001
152 7228	2PT 010 458-841	152 9552	2SD 343 910-027	1981862	2VD 012 381-211	25695440	8RA 003 326-002
152 7229	2PT 010 458-851	152 9554	2SD 344 200-001	1981863	2VP 012 381-241	26984840	8JA 001 925-001
152 7230	2PT 010 458-861	152 9555	2SD 344 200-071	1981864	2VD 012 381-261	27283512	2XD 959 011-021
152 7231	2PT 010 458-871	152 9556	2SD 344 200-311	1981865	2VD 012 381-251	27550812	2PS 003 057-051
152 7232	2PT 010 458-031	152 9556	2SD 344 200-317	1981866	2VD 012 381-281	27550812	2PS 003 057-057
152 7233	2PT 010 458-041	152 9557	2SD 959 010-401	2007611	2VP 012 381-321	28388312	2ZR 997 506-391
152 7270	1F8 007 560-341	152 9559	2SD 964 169-331	2007612	2VD 012 381-311	28816112	2BA 965 039-141
152 7353	8JE 340 165-001	152 9560	2SD 964 169-421	2007613	2VP 012 381-341	28816112	2BA 965 039-147
152 7358	2PS 008 643-021	152 9561	2VA 980 720-001	2007614	2VP 012 381-361	28817812	2XT 959 510-427
152 7358	2PS 008 643-027	152 9561	2VA 980 720-007	2007615	2VD 012 381-351	31641740	2DA 003 014-031
152 7413	2SE 004 623-001	152 9562	2VB 980 720-401	2007616	2VP 012 381-381	31641740	2DA 003 014-037
152 7413	2SE 004 623-007	152 9563	2VB 980 720-501	2028150	9EL 208 551-001	32309340	8RA 003 660-007
152 7447	9XD 344 118-101	152 9564	2VP 340 950-031	343 640071	2VA 343 640-071	32323240	8RA 002 016-121
152 7448	1GA 996 188-001	152 9565	2VP 340 950-041	343 640071	2VA 343 640-077	32483940	1GA 003 470-031
152 7449	1GA 996 188-021	152 9566	2VP 340 960-011	627 2306	2NE 001 423-011	33001900	2AA 001 200-011
152 7510	8KA 165 959-001	152 9567	2VP 340 960-021	837 057	9GD 120 670-001	33001900	2AA 001 200-012
152 7519	2PS 008 645-311	152 9568	2VP 340 960-111	855 26305	8J5 340 165-001	33135800	2JA 003 232-001
152 7544	1GA 007 506-451	152 9569	2VP 340 960-121	904 1381	2XS 950 071-031	33319100	8JA 001 930-001
152 7557	2TM 008 645-951	152 9570	2VP 340 961-011	X54 565	2BA 003 022-021	33411900	8GA 002 072-121
152 7557	2TM 008 645-957	152 9571	2VP 340 961-021	X94 684	2KA 003 168-021	34381840	2JA 001 330-001
152 7599	2RL 007 550-001	152 9572	2VP 340 961-031			34381840	2JA 001 330-007
152 7616	1F8 009 797-431	152 9573	2VP 340 961-041			34381840	2XS 005 020-021
152 7645	1F8 007 560-451	152 9574	2VP 340 961-111			3603754	1GA 006 991-041
152 7648	2AB 004 532-061	152 9575	2VP 340 961-121			363 451 40	2PF 003 389-041
152 7651	6EB 005 633-001	152 9576	2VP 340 961-131			39760812	2JA 343 720-121
152 7662	9EL 343 143-001	152 9578	2ZR 959 010-501			40032712	9EL 122 689-021
152 7663	9EL 343 142-011	152 9579	2ZR 959 820-601			41098612	9EL 132 215-001
152 7838	2XS 008 479-051	152 9580	2ZR 964 169-351			41223912	8GP 007 676-121
152 7838	2XS 008 479-057	152 9581	2ZR 964 169-361			41485440	2SK 003 567-331
152 7851	2XD 010 311-011	152 9582	2ZR 980 605-201			41485440	2SK 003 567-321
152 7962	2PG 008 645-961	152 9583	2ZR 980 605-701			42018012	9EL 120 240-011
152 7962	2PG 008 645-967	152 9586	1N8 007 560-021			42043812	9EL 147 910-001
152 7964	2PG 008 645-961	152 9587	1N8 007 560-031			42047112	9EL 131 420-001
152 7964	2PG 008 645-967	152 9588	1NE 002 537-201			42047212	9EL 131 420-011
152 8073	1F8 011 002-001	152 9589	1NE 006 300-011			42094112	2KA 003 389-211
152 8085	9MN 858 616-011	152 9590	2NE 011 172-481			42094112	2KA 003 389-217
152 8175	8KB 178 139-001	152 9591	2NE 959 821-201			42108012	8GS 007 949-261
152 8175							

Manufacturer's no. / HELLA no.

Cross-Reference



Demag	HELLA	Demag	HELLA	Dethleffs	HELLA	Dethleffs	HELLA
46000600	8GP 002 066-121	63473040	8GP 003 594-258	1105 68 5	8RA 002 020-002	1603.15.69	2XS 008 479-001
46001300	8GP 002 066-241	640916	8GP 002 068-121	1202 51 1	2SA 008 221-127	1603.15.69	2XS 008 479-007
46001500	8GA 002 071-131	64094740	8GM 002 092-121	1262 59 5	6EH 007 946-001	1603.15.69 (A 90)	2XS 008 479-001
46001600	8GA 002 071-133	640976	2AA 001 200-001	1276 38 5	2XS 005 020-077	1603.15.69 (A 90)	2XS 008 479-007
46001700	8GM 002 094-241	640983	2AA 001 200-021	1292 39 7	2PF 959 590-202	1603.15.70	2XS 008 479-011
46115640	8GM 002 091-251	640988	2AA 001 200-023	1292 39 7	2PF 959 590-207	1603.15.70	2XS 008 479-011
46123540	8HG 003 799-001	640988	8GA 002 072-121	1300 74 5	2DA 007 858-037	1603.15.70 (A 90)	2XS 008 479-011
46125740	2JA 004 531-011	640988	8GP 002 067-123	1451 28 9	8GP 002 067-121	1603.15.70 (A 90)	2XS 008 479-017
46128540	2KA 001 386-281	640988	8GP 002 067-123	1451 28 9	8GP 002 067-123	1603.15.71	8XU 008 405-031
46133740	1G4 003 470-351	641985	8RA 002 016-101	1453 70 1	1KO 008 191-001	1603.15.71	8XU 008 405-037
46134740	2SL 003 567-311	641987	2SD 001 685-211	1453 70 1	1KO 008 191-007	1603.15.73	2DA 959 071-537
46163440	2PF 003 014-071	641987	2SD 001 685-218	1485 35 8	2XA 959 790-401	1603.15.74	2BA 964 169-501
46164440	2XS 005 020-001	643709	2SB 001 259-261	1485 35 8	2XA 959 790-407	1603.15.74	2BA 964 169-507
46164440	2XS 005 020-002	648917	9DR 060 567-001	1513800	1NL 008 090-301	1603.15.75	2SB 964 169-531
46164440	2XS 005 020-003	648918	9GD 024 183-001	1513805	2BA 009 001-001	1603.15.75	2SB 964 169-537
46166040	8GP 002 067-241	649648	9EL 088 150-001	1513805	2BA 009 001-007	1603.15.76	2NE 964 169-521
46543412	8GS 861 953-011	649710	9FF 090 500-001	1529 54 1	1KO 008 191-011	1603.15.76	2NE 964 169-527
46813712	2JA 007 372-011	649711	9KS 075 307-001	1529 54 1	1KO 008 191-017	1603.15.77	2ZR 964 169-517
47033812	2PF 006 679-007	649713	9ES 015 675-001	1603.12.10	2XA 959 790-401	1603.15.77	2SA 008 221-127
47033912	2JA 006 447-041	65416240	2VA 004 887-031	1603.12.10	2XA 959 790-407	1603.15.78	6EH 007 946-001
47050190	8JA 001 909-001	65416340	2VP 004 887-021	1603.12.14	2PG 964 295-011	1603.15.84	1BL 008 194-001
47166612	2JA 001 357-002	65416440	2BM 002 847-011	1603.12.14	2PG 964 295-017	1603.15.85	1BL 008 194-007
47196612	9FF 078 830-001	65416540	2BM 002 847-021	1603.12.6	2PF 004 081-017	1603.15.85	8WT 008 549-101
47233512	8GA 006 841-241	65440740	8RA 003 326-031	1603.12.8	2PG 003 057-011	1603.15.88	2PF 008 221-011
47242612	9XR 855 975-001	65450440	2PS 003 748-121	1603.14.12	8RA 002 020-001	1603.15.90	2PF 008 221-017
47254412	5DS 010 668-001	65450440	2PS 003 748-127	1603.14.12	8RA 002 020-002	1603.15.90	2XS 005 020-077
47254412	5DS 010 668-011	65458040	2EA 001 259-611	1603.14.18	8RA 343 160-017	1603.15.91	2XT 007 945-027
47399412	9EL 340 829-001	65492040	2TM 006 717-047	1603.14.2	8RA 003 326-021	1603.16.12	8GA 002 073-121
47399512	9EL 340 829-011	65500040	2PS 003 748-167	1603.14.7	8RA 002 016-101	1603.17.02	8GA 002 073-123
47400012	2PT 177 696-831	65500040	2PS 003 748-167	1603.14.7	8RA 004 412-021	1603.17.02	8GP 002 067-123
47454112	9EL 859 020-101	66618240	2BA 001 259-611	1603.14.8	8RA 004 412-001	1603.17.10	8GP 002 067-123
49058240	8JB 004 777-001	66618240	2BA 001 259-618	1603.15.1	2XS 005 020-001	1603.17.10	8GP 002 067-123
49058240	8JB 004 777-002	66618240	2BA 001 259-618	1603.15.1	2XS 005 020-002	1603.17.13	8GP 003 594-121
49468200	9EL 146 491-001	666183	8GM 002 091-121	1603.15.1	2XS 005 020-003	1603.17.14	8GA 002 071-123
500 459 98	8GP 002 068-121	666184	2SA 001 259-751	1603.15.10	2XS 005 020-137	1603.17.14	8GA 002 071-123
500 459 98	8GP 002 068-241	666184	2SA 001 259-757	1603.15.10	2PS 006 717-031	1603.17.40	8GP 002 066-121
500 461 98	8GM 002 091-131	66618400	2SA 001 259-751	1603.15.10	2PS 006 717-037	1603.17.42	8GA 006 841-121
50046298	8GM 002 091-121	66618400	2SA 001 259-757	1603.15.100	2SB 964 169-287	1603.17.42	8GA 006 841-123
50092698	8GA 002 074-241	666185	8GM 002 091-131	1603.15.101	2DA 007 858-037	1603.17.43	8GP 003 594-121
50131398	8GP 002 095-121	666419	8GP 002 095-121	1603.15.108	8RA 002 016-111	1603.17.44	8GD 002 078-121
50134398	8GP 002 095-241	672741	8GP 002 066-121	1603.15.11	2PS 962 964-031	1603.19.17	2JA 003 231-011
50140898	8GJ 002 525-251	69850573	8PF 001 259-631	1603.15.11	2PS 962 964-037	1603.50.123	2AA 003 257-031
50140898	8GJ 002 525-258	69856073	2JA 003 354-001	1603.15.115	2DA 008 136-031	1603.50.243	5DS 010 668-001
50226212	2BM 008 355-017	76224673	8JB 850 434-011	1603.15.116	1KO 008 191-001	1603.50.57	2AA 001 200-141
50226312	2PS 964 295-051	76224773	9GH 096 532-001	1603.15.116	1KO 008 191-007	1603.50.88	2AA 003 257-001
50226312	2PS 964 295-057	76515273	8GM 002 090-251	1603.15.118	2KA 004 331-061	1606.07.9	8KW 701 235-033
50226312	2PS 964 295-347	76515273	8GH 002 090-253	1603.15.118	2KA 004 331-067	1608.67.8	8GM 002 092-121
50226412	1NO 009 295-057	76515273	8GH 002 090-258	1603.15.119	2XS 005 020-057	1626.61.7	9EL 141 135-021
50226512	2PT 010 458-831	76515373	8GM 002 091-261	1603.15.12	9GT 963 129-001	1626.62.5	8GP 003 594-251
50226612	1NO 009 295-067	76515473	8GA 002 074-241	1603.15.123	2DA 008 136-017	1626.63.2	9EL 132 215-001
50226812	2JA 343 570-041	76961873	8GS 007 949-261	1603.15.141	2BA 009 001-071	1626.63.7	8KA 146 751-007
50228112	2PF 340 825-001	76961973	5VD 990 264-011	1603.15.141	2BA 009 001-077	1697.46.3	2BA 009 001-071
50373299	8GM 002 092-241	77145500	8RA 003 503-001	1603.15.142	2BM 006 692-011	1697.46.3	2BA 009 001-077
50373799	8GP 002 067-121	77797273	2JA 004 531-011	1603.15.142	2BM 006 692-017	1697463 X1603.15.200	2BA 009 001-071
50373799	8GP 002 067-123	77878673	2JA 003 231-001	1603.15.143	2BM 006 692-021	1778.97.8	2VP 343 520-061
50373799	8GA 002 073-241	78001673	9ES 120 743-001	1603.15.143	2BM 006 692-027	1778.97.8	2VP 343 520-067
50373799	8GA 002 073-248	78001973	9GT 067 751-001	1603.15.155	2PT 177 696-801	1778.98.1	2VP 343 520-051
50373799	8GA 002 071-251	78002073	9EL 856 416-001	1603.15.159	2DA 343 106-021	1778.98.1	2VP 343 520-057
50373799	8GA 002 071-258	78002673	9EL 134 659-001	1603.15.159	2DA 343 106-027	1817.13.7	2PT 177 696-801
50373799	8GA 002 071-241	78002773	9EL 134 660-001	1603.15.160	2DA 343 106-001	1846.69.3	2KA 003 389-061
50373799	8GA 002 071-248	78007673	9EL 122 772-001	1603.15.160	2DA 343 106-007	1846.69.3	2KA 003 389-068
50373799	8GP 002 067-241	78011073	2SE 002 578-701	1603.15.161	2KA 003 389-061	1846.69.3	2PS 009 226-021
50382998	8GP 002 068-241	78011073	2SE 002 578-707	1603.15.161	2KA 003 389-062	1853.62.0	2PS 009 226-027
50383899	8GH 002 089-251	89674540	1JA 998 534-011	1603.15.161	2KA 003 389-068	1853.62.0	8RA 344 065-007
50383899	8GH 002 089-253	90022400	2BE 001 278-011	1603.15.163	2BE 010 102-001	1882.79.6	2PT 010 458-811
50383899	8GH 002 089-258	90052300	8GM 002 094-121	1603.15.164	1AL 009 998-001	1882791	5DS 010 668-001
50383899	8GP 002 068-241	960902	2JA 110 536-001	1603.15.167	1KO 247 043-011	1883.16.5	2BE 010 102-001
50745312	2PT 010 981-871	962528	9EL 001 330-001	1603.15.167	1KO 247 043-017	1893.93.8	1AL 009 998-001
50753112	8GA 006 841-241	962528	2JA 001 330-007	1603.15.168	1NA 010 047-101	1893.94.1	1KO 247 043-011
514979	2BE 001 278-021	962540	2KA 001 389-101	1603.15.169	8XX 010 315-001	1893.94.7	1KO 247 043-011
514980	2BE 001 278-011	962545	2BA 001 227-201	1603.15.170	2SD 343 440-057	1893.94.7	1KO 247 043-011
52285440	2AB 004 532-051	962557	8GA 002 071-131	1603.15.171	2SK 343 440-067	1896.39.0	1NA 010 047-101
52285440	2AB 004 532-057	962557	8GA 002 071-133	1603.15.172	2SD 343 440-017	1898.87.7	2SD 343 440-017
55121540	2BM 006 692-011	9625800	2JA 001 330-001	1603.15.173	2SK 343 440-027	1898.87.6	2SK 343 440-027
55121540	2BM 006 692-017	9625800	2JA 001 330-007	1603.15.176	8XX 010 315-101	1898.87.7	2SD 343 440-057
55121640	2BM 006 692-021	966680	1G5 003 241-021	1603.15.2	2KA 001 378-127	1898.88.1	2SK 343 440-067
55121640	2BM 006 692-027	966682	9GD 120 670-001	1603.15.208	6NM 007 282-221	1977.85.1	8XX 010 315-101
55122540	8RA 002 023-001	966683	6ED 708 919-001	1603.15.32	2VA 007 502-011	1977.85.1	1NO 009 295-801
55125040	1AB 003 177-071	967265	9EL 087 769-001	1603.15.32	2VA 007 502-017	2095.98.4	2PT 177 696-801
55125140	2BA 002 652-101	97347573	1G5 003 241-081	1603.15.33	2VA 007 502-021	2090.73.5	5DV 008 855-001
55125140	2BA 002 652-107	97392273	8JA 003 526-001	1603.15.34	2DA 007 421-001	2090.73.5	5DV 008 855-007
55125340	1VB 005 444-037	97683473	1A3 005 760-501	1603.15.34	2DA 007 421-007	2118.27.6	8RA 004 412-021
55125440	2VP 004 887-021	97683473	1A3 005 760-507	1603.15.36	2VP 007 502-127	2346896	1BL 010 820-001
55125540	2VA 004 887-031	97683573	8GJ 002 525-131	1603.15.37	2VA 007 502-117	2346914	2AA 001 204-001
55125640	8RA 002 023-001	97683573	8GJ 002 525-136	1603.15.38	1BL 008 193-001	2500407 X1603.15.219	1JA 010 820-021
55135740	8HG 006 294-051	97806273	9EL 859 020-001	1603.15.38	1BL 008 193-007	5102019	8AL 001 930-001
55135840	1G8 002 340-011	97806373	9GP 859 115-001	1603.15.39	1KO 008 191-001	X1603.12.14	2PG 964 295-011
55398240	1GA 998 522-011	97806573	2PF 006 679-007	1603.15.39	1KO 008 191-007	X1603.12.14	2PG 964 295-017
57620840	2RL 006 846-011	97806673	8GA 002 071-251	1603.15.40	9GH 152 654-007	X1603.12.9	2PF 959 590-202
57649240	2BA 001 221-031	97806673	8GA 002 071-258	1603.15.41	2BA 008 221-001	X1603.12.9	2PF 959 590-



Manufacturer's no. / HELLA no. Cross-Reference

Deutz	HELLA	Deutz	HELLA	Deutz	HELLA	Deutz	HELLA
0.900.1268.1	9DX 860 438-001	043 70260	9EL 118 700-001	166075	4RD 933 332-041	CC6 262011	2SA 003 057-021
0.900.2016.2	8GA 006 841-121	043 84138	9GH 126 647-011	166484	2SE 002 578-701	CC6 269004	9EL 116 907-001
0.900.2016.2	8GA 006 841-123	043 85089	2KA 003 389-061	166845	1EA 996 074-051	CC6 269005	9EL 117 330-001
0.900.2057.5	9EL 862 678-001	043 85089	2KA 003 389-062	166846	1EA 996 074-061	CC6 269006	9EL 117 330-011
0.900.2057.7	9EL 863 100-031	043 85089	2KA 003 389-068	167906	1AB 996 157-091	D04 413298	8RA 004 412-021
000 9739002	9EL 043 137-001	043 89584	2BE 002 776-251	2.8039.011.0	1KL 998 570-031	D11 25492720	2BE 003 018-011
000 9739003	8XS 113 389-001	043 89584	2BE 002 776-257	2.8039.016.0	1GA 996 261-511	D11 55492210	2SB 003 018-031
000 9740211	2SW 003 014-131	043 89586	2BE 002 776-261	2.8039.017.0	1G0 996 176-061		
000 9740212	2SD 003 182-061	043 89586	2BE 002 776-267	2.8039.018.0	1G0 996 176-131		
000 9740212	2SD 003 182-067	043 89588	2SE 002 776-211	2.8039.018.0	1G0 996 176-137		
000 9740213	2SD 003 182-051	043 89588	2SE 002 776-217	2.8039.019.0	1G0 996 176-131		
000 9740213	2SD 003 182-057	043 89594	2SD 002 776-241	2.8039.019.0	1G0 996 176-137		
000 9740400	1SO 001 430-011	043 89594	2SD 002 776-247	2.8039.023.0	1G0 996 176-041		
000 9740600	2SB 003 018-031	043 90876	9EL 134 739-001	2.8039.024.0	1G0 996 176-041		
000 9741013	2BE 001 278-011	043 90876EY1065-49	9EL 134 739-001	2.8039.110.0/01	1GA 007 506-111		
000 9741022	2BA 002 652-111	043 90877	9EL 134 741-021	2.8039.313.0	1AL 009 998-001		
000 9741022	2BA 002 652-117	043 90877EY1065-49	9EL 134 741-021	2.8039.314.0	1K0 247 043-167		
000 9741023	2BA 002 652-121	043 90878	9EL 137 308-001	2.8039.324.0	1K0 008 191-011		
000 9741023	2BA 002 652-127	043 90878EY1065-49	9EL 137 308-001	2.8039.324.0	1K0 008 191-017		
000 9741028	2BA 003 014-111	043 90879	9EL 134 742-021	2.8059.011.0	2SA 008 221-127		
000 9741104	2TJ 001 633-211	043 90879EY1065-49	9EL 134 742-021	2.8059.012.0	2DA 008 221-167		
000 9741500	2AA 001 200-021	043 91462	1GA 006 991-021	2.8059.013.0	2BA 008 221-147		
000 9741500	2AA 001 200-023	043 91462	1GA 006 991-091	2.8059.014.0	2BA 008 221-107		
000 9741700	2XW 003 146-001	043 91462	1GA 998 522-011	2.8059.015.0	2PF 008 221-177		
000 9746015	9EL 087 769-001	043 96049	2KA 001 378-041	2.8059.039.0	2PF 009 001-081		
000 9746024	9EL 052 476-001	044 03158	2SD 002 776-241	2.8059.530.0	2BA 009 001-201		
000 9746027	9EL 113 639-021	044 03158	2SD 002 776-247	2.8059.530.0	2SB 009 362-041		
000 9746031	9EL 088 525-001	044 03159	2SE 002 776-211	2.8059.532.0	2SB 009 362-021		
000 9746034	9EL 110 540-001	044 03159	2SE 002 776-217	2.8059.534.0	2BA 009 001-191		
000 9746035	9EL 115 003-011	044 03161	9EL 137 308-001	2.8059.536.0	2BE 010 102-001		
000 9746036	9EL 118 614-011	044 03162	9EL 137 307-001	2.8059.542.0	2PF 959 590-247		
000 9746038	9EL 110 536-011	044 11937.4	1GA 007 506-001	2.8059.545.0	2BA 009 001-001		
000 9747905	9FF 090 500-001	044 11937.4	1GA 007 506-002	2.8059.545.0	2BA 009 001-007		
000 9748101	9ES 015 675-001	044 11937.4	1GA 007 506-007	2.8059.546.0	2SB 009 001-061		
000 9748201	9DR 090 206-001	044 11937.4	1GA 007 506-081	2.8059.546.0	2SB 009 001-067		
000 9748202	9DR 090 206-001	044 13298	8RA 004 412-021	2.8059.547.0	2DA 009 001-051		
000 9748203	9DR 066 847-001	044 13298	8RA 004 412-021	2.8059.547.0	2DA 009 001-057		
000 9748300	9GD 023 639-001	044 13298EY2005-49	8RA 004 412-021	2.8210.004.0	8GA 002 083-131		
000 9748305	9GD 024 183-001	044 13298X	8RA 004 412-001	2.8349.017.0	8RA 009 001-031		
000 9748315	9GD 120 670-001	044 14773	2RL 006 846-001	2.8349.017.0	8RA 009 001-037		
000 9748403	9KS 075 139-001	044 24195.4	1GA 007 506-001	230 5218E1053-49	9GD 024 183-001		
000 9748404	9AG 071 903-001	044 24195.4	1GA 007 506-002	233 2194EY1001-49	9EL 104 571-041		
000 9748405	9KS 075 307-001	044 24195.4	1GA 007 506-007	233 2197E1001-49	9EL 104 571-031		
010 70028	8GP 002 068-241	044 25599.4	1GA 007 506-001	233 2197EY1001-49	9EL 104 571-031		
011 01600	8JA 001 915-001	044 25599.4	1GA 007 506-002	237 7137KZ	2SD 002 776-241		
011 02258	8GH 002 090-133	044 25599.4	1GA 007 506-007	237 7137KZ	2SD 002 776-247		
011 02258	8GH 002 090-136	044 26316	2JA 006 487-347	237 7139KZ	2SE 002 776-211		
011 03089	8HG 002 365-001	044 34891	1GB 006 213-111	237 7139KZ	2SE 002 776-217		
011 35950	8GD 002 078-121	044 34891	1GB 006 213-117	237 7448KZ	2BE 002 776-251		
011 45162	9KD 116 415-005	044 34892	1AB 006 213-001	237 7448KZ	2BE 002 776-257		
011 45200	2BM 002 652-031	044 34950	1GA 007 506-061	237 7450KZ	2BE 002 776-261		
011 6006018	2XS 005 020-001	044 34950	1GA 007 506-111	237 7450KZ	2BE 002 776-267		
011 6006018	2XS 005 020-002	044 39648	9EL 118 697-001	238 1368EY1202-49	9KS 071 571-001		
011 6006018	2XS 005 020-003	044 50666	1GA 998 522-011	238 1669EY1210-49	9EL 109 208-011		
011 6046038	1GA 007 506-001	062 17169	2BA 002 324-011	238 1675EY1210-49	9EL 088 538-001		
011 6046038	1GA 007 506-002	062 17170	2BA 002 324-021	238 1678EY1210-49	9GT 005 166-001		
011 6046038	1GA 007 506-007	062 17171	2BA 003 014-011	280 390070	1GA 996 161-121		
011 6046082	2BA 002 652-111	062 17172	2BA 001 227-201	280 39160.3	1GA 007 506-121		
011 6046082	2BA 002 652-117	062 17182	9EL 110 536-001	280 392950	1GA 007 506-001		
011 6046084	2BA 002 652-121	062 17218	2BE 003 347-001	280 392950	1GA 007 506-002		
011 6046084	2BA 002 652-127	062 17218	2KA 001 386-231	280 392950	1GA 007 506-007		
011 69308	2AB 001 208-001	062 57809	2JA 001 330-001	280 392950	1GA 007 506-001		
011 69440	2AA 001 201-011	062 57809	2JA 001 330-007	280 392950	1GA 007 506-002		
011 75862	8JA 003 526-001	062 77521	2PF 003 014-071	280 392950	1GA 007 506-007		
012 62462	2AA 001 204-031	062 77522	2SA 003 014-051	280 392960	1GA 007 506-001		
012 62567	2AA 001 204-001	065 15208	2PG 003 057-011	280 392960	1GA 007 506-002		
012 76024	9KS 075 307-001	065 15208	2SA 003 057-021	280 392960	1GA 007 506-007		
013 00971	9ES 015 675-001	065 26511	2ZR 003 014-091	280 39298020	1GA 996 161-121		
023 05218	9GD 024 183-001	065 27091	2SB 003 014-151	280 392990	1GA 996 161-121		
023 06631	2SD 001 306-061	065 32698	9EL 119 544-111	306 1399M8	2BE 003 018-011		
023 06632	2SE 001 306-051	065 38035	2XS 005 020-017	320 363390	8HG 002 365-001		
023 32194	9EL 104 571-041	065 38035	2KA 001 386-231	341 6605EE145-80	8JA 001 909-011		
023 32197	9EL 104 571-031	065 38036	1SO 001 430-011	412 75941	1H3 002 456-012		
023 62524/10	2SD 002 776-231	089-004120-2.031	9DR 090 206-001	415 3200021	2DA 003 014-031		
023 62524/10	2SD 002 776-237	089-004126-2.031	9DR 090 206-001	415 3200022	2DA 003 014-037		
023 72742	2BE 001 259-061	089-004140-1.110	2BA 003 014-111	415 3200022	2BA 003 014-011		
023 72744	2JA 001 364-001	089-004147-1.002	2TM 003 057-031	431 6450KY1006-49	2SD 001 693-011		
023 77137	2SD 002 776-241	089-004148-1.010	2AA 001 200-011	432 2879EY1024-49	9FF 111 606-021		
023 77137	2SD 002 776-247	089-004148-1.010	2AA 001 200-012	432 6233EY1212-49	9AG 104 328-001		
023 77139	2SE 002 776-211	090 015403	8GP 002 067-121	432 6298EY1212-49	9DR 104 336-001		
023 77139	2SE 002 776-217	091 200007-7826	1GA 005 060-001	432 6299EY1212-49	9FH 093 887-001		
023 77448	2BE 002 776-251	091 207002-1.936	9EL 110 540-001	432 6362	1A3 003 370-041		
023 77448	2BE 002 776-257	091 207002-4631	9EL 120 224-001	432 6362KZ1030-49	1A3 003 370-041		
023 77450	2BE 002 776-261	091-207002-1.935	9EL 110 542-001	433 5601EY1030-49	1A3 125 195-015		
023 77450	2BE 002 776-267	110 3089EY8876-81	8HG 002 365-001	433 6132EY1030-49	9GD 120 670-001		
023 81368	9KS 071 571-001	116 9308EY8207-22	2AB 001 208-001	433 7596EY1030-49	9FF 090 500-001		
023 81669	9EL 109 208-011	117 5862EY8239-70	8JA 003 526-001	434 0118EY1024-49	2JA 003 231-001		
023 81675	9EL 088 538-001	127 6024EY8751-80	9KS 075 307-001	436 5082KZ1212-49	2BE 003 014-251		
023 81678	9GT 005 166-001	130 0971EY0000-00	9ES 015 675-001	436 5082KZ1212-49	2BE 003 014-257		
029 14462	2SB 001 301-021	160 05189	2SD 006 040-141	436 5083EY1212-49	9EL 115 003-055		
029 41615	8GH 008 357-001	160 05189	2SD 006 040-147	437 0259EY1075-49	9EL 118 701-001		
031 46605	8JA 001 909-011	160 06018	2XS 005 020-001	437 0260EY1075-49	9EL 118 700-001		
034 16605	8JA 001 909-011	160 06018	2XS 005 020-002	438 4138EY1101-49	9GH 126 647-011		
043 08197	1G3 996 001-0						

Manufacturer's no. / HELLA no.

Cross-Reference



Doll	HELLA	Erich Jäger	HELLA	Ernst Auwärter	HELLA	Ernst Auwärter	HELLA
7115885	2XS 340 447-021	035285	2KA 003 389-068	11025258	2SB 005 603-137	11073769	9GH 152 654-007
7115913	8RA 004 412-021	035287	2XS 950 071-031	11025264	2NE 003 236-001	11073770	2DA 959 071-737
7122890	9XX 340 173-801	035332	2VP 004 887-021	11025264	2NE 003 236-008	11073787	2BA 008 221-041
7126234	2VD 007 500-411	035333	2PS 004 361-001	11025265	9EL 119 544-001	11073787	2BA 008 221-047
7126235	2VP 007 500-421	035334	2KA 003 389-001	11025268	2SD 003 184-041	11073789	8RA 002 016-111
7127981	1GM 996 136-192	035337	2VB 004 887-011	11025268	2SD 003 184-047	11073790	2SA 008 405-011
7130563	8HG 990 003-001	035339	9GT 141 941-001	11025271	9EL 118 700-001	11073790	2SA 008 405-017
7133470	2KA 010 278-031	035346	2VA 004 887-031	11025273	2SA 003 236-341	11073881	8KA 152 134-007
7136622	2PS 008 645-611	035369	2SD 003 167-011	11025274	2SA 003 236-041	11074966	1K0 008 191-041
714 5984	1GA 996 188-001	035374	2XS 955 260-001	11025274	2SA 003 236-048	11074966	1K0 008 191-047
7140789	8KL 340 050-001	035374	2XS 955 260-007	11025275	9EL 119 544-031	11075005	8GA 006 841-241
7146553	2XD 010 311-011	035378	2NE 003 236-001	11025278	2SA 005 603-021	11075350	2BA 008 221-001
7147525	8KB 990 299-011	035378	2NE 003 236-008	11025278	2SA 005 603-027	11075350	2BA 008 221-007
7165495	1GA 996 189-001	035415	2XS 005 020-011	11025285	9EL 122 772-001	11075368	9GT 137 236-007
7169613	2ZR 996 188-061	035591	2KS 005 020-002	11025286	2SK 003 567-331	11077651	8GH 007 157-241
7169639	2KA 010 278-051	035598	2PS 008 645-011	11025294	2BA 003 236-541	11079412	8XU 008 405-031
7169910	2RL 010 979-001	035599	2KS 007 841-011	11025298	2ZR 001 240-377	11079412	8XU 008 405-037
7177329	2SB 959 010-301	035599	2KS 007 841-011	11025300	2SD 003 184-041	11080679	2JB 996 012-121
7177329	2SB 959 010-307	035600	2XS 007 841-021	11025300	2SD 003 184-047	11082857	2ZR 003 315-041
7186289	2JA 343 660-117	035601	9EL 148 673-021	11025311	1NL 007 186-021	14002128	1BL 005 380-011
7186298	2JA 959 037-511	035720	2VP 007 907-031	11025311	1NL 007 186-027	14002129	1BL 005 380-021
7191404	2XD 010 311-011	035820	2PS 008 645-187	11025312	9GH 147 009-007	14003662	2NE 003 030-151
7201597	8XT 002 117-001	036239	2PS 008 645-011	11025314	1BL 007 834-007	14003663	2ZR 003 030-171
7211088	2XS 011 768-061	036351	8GA 002 073-241	11025316	9HD 155 239-001	14003665	9EL 109 208-011
7221223	1GA 006 991-051	036353	8GA 002 071-241	11025320	1KL 007 834-027	14009005	9EL 137 241-001
7224483	2VP 340 930-111	036354	8GM 002 092-241	11025322	1NL 007 834-017	14009006	8RA 003 326-021
7224484	2VP 340 930-101	036355	8GP 003 594-251	11025323	2BA 005 603-117	14015027	8JD 156 151-807
8172528	8KW 701 235-033	036356	8GP 002 067-241	11025324	8RA 002 016-121	1402.300.0	2SK 003 567-321
8176024	1FE 006 300-001	036357	8GA 002 071-131	11025324	9GT 134 655-007	1402.301.0	2SK 003 567-331
8176061	1G8 002 340-001	036385	9EL 340 829-001	11025326	2BE 004 119-021	14022.000	2SK 003 567-661
8176064	1G5 003 241-071	036386	9EL 340 829-011	11025327	9GT 134 655-007	14022.010	2SL 003 567-691
8176067	1GA 996 522-011	036391	9EL 340 829-021	11025328	9GT 143 133-007	1407.300.0	2JA 003 232-001
8176068	1G3 996 001-301	036422	2VP 340 400-141	11025329	1NL 007 186-047	14087.000	2PG 003 057-011
8176069	1G3 005 760-221	036422	2VP 340 400-147	11025330	1BL 007 834-037	14087.510	9EL 117 334-001
8176069	1G3 005 760-227	036489	2VP 340 400-151	11025336	2SD 003 184-031	14088.000	2PF 001 648-161
8176087	2ZR 003 236-051	036489	2VP 340 400-157	11025336	2SD 003 184-037	14090.000	2PS 006 717-031
8176107	2ZR 003 236-057	056548	9GT 074 132-001	11025337	2SE 997 111-011	14090.000	2PS 006 717-037
8176110	2NE 003 236-001	057642	4RA 003 530-001	11025338	2SE 997 111-021	14096.010	1GA 006 876-001
8176110	2NE 003 236-008	731013000	2BA 007 135-001	11025342	ZZR 002 694-001	14314004	8GP 002 067-241
8176117	2SD 001 680-271	740014000	2BA 007 135-001	11025343	2ZR 003 236-311	1502.0204.00	2NE 005 603-071
8176118	2SD 001 680-281	7642	4RA 003 530-001	11025344	2TM 003 748-011	1502.0204.00	2NE 005 603-077
8176128	2SD 001 685-231	960027	2SK 003 567-331	11025346	2ZR 005 603-061	1502.204.00	2NE 005 603-071
8176128	2SD 001 685-232	960028	2SK 003 567-321	11025346	2ZR 005 603-067	1502.204.00	2NE 005 603-077
8176129	2SA 001 259-751	960088	2XS 955 260-001	11025347	2ZR 005 603-061	1502.205.00	2SK 003 567-661
8176129	2SA 001 259-757	960088	2XS 955 260-007	11025347	2ZR 005 603-067	1502.206.00	2SK 003 567-651
8176131	2SD 001 685-211	960139	2XS 005 020-077	11025348	2KA 001 378-041	1502.207.00	9HB 126 601-001
8176131	2SD 001 685-218	960151	2PG 962 964-051	11025349	2KA 005 049-011	1503.000.00	9GH 145 943-001
8176139	2SD 003 167-021	960151	2PG 962 964-057	11025349	2KA 005 049-017	1503.004.00	2BM 002 847-011
8176144	2SD 001 699-061	960152	9GD 963 281-001	11025350	2KA 003 389-061	1503.004.01	9EL 115 830-001
8176145	2SK 003 567-321	960153	9GT 963 129-001	11025350	2KA 003 389-062	1503.005.00	2BM 002 847-021
8176146	2XS 005 020-011	962146	2SD 003 167-021	11025350	2KA 003 389-068	1503.009.00	2BA 001 221-031
8176146	2XS 005 020-017	962147	2SD 003 167-011	11025356	2KA 005 049-011	1503.010.00	2BA 001 221-041
8176147	2SK 003 567-331	962195	2SE 003 167-041	11025356	2KA 005 049-017	1503.012.00	2BA 003 236-321
8176148	2SE 001 685-221	962196	2SE 003 167-031	11025369	9EL 118 701-001	1503.013.00	2BA 003 236-021
8176148	2SE 001 685-227	962198	2KA 003 389-001	11025421	2SK 003 567-321	1503.013.00	2BA 003 236-027
8176149	2SE 001 685-201	962236	2XS 005 020-011	11025422	2SK 003 567-331	1503.013.02	9EL 119 544-021
8176154	2SE 003 167-031	962236	2XS 005 020-017	11025442	8RA 003 326-041	1503.016.00	2BA 003 734-061
8176155	2SD 003 167-011	962788	2PF 001 259-677	11025442	8RA 003 326-047	1503.016.00	2JA 004 531-011
8176165	2SE 001 699-071	962947	2NE 003 236-001	11025445	8RA 003 660-007	1503.043.00	2BA 005 603-011
8176173	2PF 001 259-631	962953	2JA 004 531-011	11025448	8RL 002 009-021	1503.043.00	2BA 005 603-017
8176174	2PF 001 634-101	962953	2SD 004 431-011	11025454	8RB 004 713-001	1503.052.00	2BA 001 259-611
8176178	2XS 003 168-081	962954	8GA 002 073-251	11025462	2SA 001 647-041	1503.052.00	2BA 001 259-618
8176178	2XS 005 020-011	962955	8GA 002 071-251	11025464	2PF 961 167-021	1503.065.00	2KA 003 389-001
8176178	2XS 005 020-017	962967	2PS 003 748-161	11025468	2PF 003 014-071	1503.081.00	2ZR 003 236-051
8176181	2XS 950 071-031	962967	2PS 003 748-167	11025475	1NL 007 186-021	1503.081.00	2ZR 003 236-057
8176185	2XS 005 020-081	962968	2KA 007 929-001	11025475	1NL 007 186-027	1503.082.00	8RA 003 326-011
8176191	2KA 001 386-281	962968	2KA 007 929-007	11025475	2JL 005 590-001	1503.082.00	8RA 003 326-017
8176192	2KA 001 389-101	962970	2ZR 003 236-051	11025485	2RL 008 061-111	1503.101.00	2DA 003 236-331
8176196	2KA 003 389-001	962970	2ZR 003 236-057	11025488	2SA 001 638-021	1503.102.00	2DA 003 236-031
8176200	2SA 003 057-021	962971	2SL 003 567-311	11025489	2PF 001 638-011	1503.102.00	2DA 003 236-037
8176205	2XS 005 020-091	962972	9EL 122 772-001	11025491	2XS 005 020-001	1503.102.01	9EL 120 201-001
8176221	2RL 006 846-011	963072	2PS 008 382-801	11025491	2XS 005 020-002	1503.103.00	2ZR 003 236-051
8176227	8HG 002 365-001			11025493	2XS 005 020-003	1503.103.00	9EL 120 201-001
8176232	9GD 856 863-001			11025493	2XS 007 841-011	1503.105.00	9EL 110 014-001
8176237	2JA 004 531-011	005603037	2BA 005 603-011	11025493	2XS 007 841-017	1503.108.00	2DA 005 603-031
8176238	2JA 001 364-001	10228	2BA 005 603-017	11025494	2XS 007 841-021	1503.108.00	2DA 005 603-037
8176279	2AA 003 257-031	10228	2PS 962 964-037	11025530	2JA 004 531-011	1503.114.00	9GD 100 140-001
8176863	9EL 109 139-001	11025.345	9EL 119 544-111	11025532	2SA 001 259-751	1503.141.00	2ZR 003 014-091
8176865	9EL 113 324-001	11025.544	9EL 116 607-005	11025532	2SA 001 259-757	1503.142.00	2BM 006 692-011
8176868	9EL 122 772-001	11025087	2NE 005 603-071	11025542	2JA 003 231-001	1503.142.00	2BM 006 692-017
8176869	9EL 118 633-001	11025087	2NE 005 603-077	11025545	2JA 003 354-051	1503.143.00	2BM 006 692-021
8176884	9BG 101 230-001	11025087	2NE 005 603-077	11025547	2JA 001 331-011	1503.143.00	2BM 006 692-027
8176891	9EL 854 912-001	11025089	2SK 003 567-661	11025566	2JA 001 364-001	1503.145.00	2SA 006 679-027
8176901	9EL 950 315-031	11025092	2SK 003 567-651	11025583	2AB 004 532-051	1503.148.00	2PS 962 964-012
8176902	9EL 856 416-001	11025155	9GH 145 943-001	11025583	2AB 004 532-057	1503.148.00	2PS 962 964-018
8177151	8GA 002 073-241	11025162	2BM 002 847-011	11025585	9XB 136 20		



Manufacturer's no. / HELLA no. Cross-Reference

Ernst Auwärter	HELLA	Ernst Auwärter	HELLA	Ernst Auwärter	HELLA	Evobus	HELLA
1503.242.00	2BA 005 603-011	2602.119.01	2XW 007 146-001	826-RS 007	8RA 008 405-007	003 820 55 56 01	2PT 965 039-177
1503.243.00	2BA 005 603-017	348-ST001	8JA 001 930-001	826-RS003	8RA 003 326-011	003 826 63 90	9EL 119 544-212
1503.243.02	1BL 007 834-007	348-ST002	8JB 001 943-001	826-RS003	8RA 003 326-017	370 820 00 50	1GB 956 080-011
1503.244.00	9HD 155 239-001	612.181111	2RL 008 181-111	826-RS004	8RA 003 326-041	370 820 00 65	8JA 002 963-001
1503.244.01	1KL 007 834-027	635-WBL001	2XW 007 146-001	826-RS004	8RA 003 326-047	372 820 00 39	2PT 008 935-801
1503.244.00	1KL 007 834-027	821-BL032	2BA 008 221-001	826-RS008	8RA 003 326-031	372 826 00 47	2PF 004 081-001
1503.245.00	1NL 007 834-017	821-BL032	2BA 008 221-007	841-DLA001	2JA 001 331-011	6 290 010 089 1 14	2PF 004 081-007
1503.246.00	2BA 005 603-117	821-BL035	2BM 008 355-017	841-DLE006	2JA 002 661-001	6 290 010 089 1 14	2PF 004 081-007
1503.247.00	8RA 002 016-121	821-ET051	9GH 158 051-007	841-KL001	2JA 001 364-001	612 820 00 56	2KA 005 049-008
1503.250.00	2BA 005 603-117	821-ET058	9GH 152 654-007	841-KL002	2JA 001 335-011	612 820 00 56	2KA 005 049-011
1503.250.01	2BE 004 119-021	821-FSW006	1K0 008 191-021	841-S0002	2AB 004 532-051	612 820 00 56	2BM 008 355-007
1503.250.01	9GT 134 655-007	821-FSW006	1K0 008 191-027	841-S0002	2AB 004 532-057	612 820 01 20	2BM 008 355-007
1503.250.02	9GT 143 133-007	821-FSW006/FSW008	1K0 008 191-021	841-SO002	2AB 004 532-051	612 820 01 20	2PS 962 964-031
1503.252.00	1BL 007 834-037	821-FSW006/FSW008	1K0 008 191-027	841-SO002	2AB 004 532-057	613 826 02 41	2PS 962 964-037
1503.253.00	2SD 003 184-037	821-HSW036	1BL 008 193-011	A 104 ST	2XS 007 841-011	627 820 00 20	2PT 009 496-007
1503.253.00	2SD 003 184-037	821-HSW036	1BL 008 193-017	A 104 ST	2XS 007 841-017	628 820 04 56	2DA 343 106-011
1503.254.00	2SE 997 111-011	821-HSW036/FSW007	1BL 008 193-017	Evobus	HELLA	628 820 05 56	2DA 343 106-017
1503.255.00	2SE 997 111-021	821-HSW036/FSW007	1BL 008 193-017	000 544 11 04	2NE 003 236-001	628 820 05 56	9GS 146 999-727
1503.300.00	2ZR 002 694-001	821-HSW038	1N0 009 295-057	000 544 11 04	2NE 003 236-008	628 820 05 56	2PT 009 496-007
1503.301.00	2ZR 001 193-011	821-HSW039	1N0 009 295-067	000 544 11 04-00	2NE 003 236-001	628 899 00 94	2PT 009 496-007
1503.302.00	2ZR 003 236-311	821-PL004	2PF 006 679-007	000 544 11 04-00	2NE 003 236-008	628 892 00 456	2PT 009 496-007
1503.303.00	2TM 003 748-011	821-PL007	2PS 006 717-037	000 544 18 04	2NE 003 236-301	628-08.50.359-10.4	2PT 009 496-007
1503.303.01	9EL 119 544-111	821-PL007	2PS 006 717-037	000 544 18 04-00	2NE 003 236-301	629-00.40.500-10.4	2PT 008 935-801
1503.307.00	2ZR 005 603-061	821-PL007A	2PS 006 717-037	000 544 24 07	2ZR 003 236-051	666 820 03 56	2PF 003 563-151
1503.307.00	2ZR 005 603-067	821-PL007A	2PS 006 717-037	000 544 24 07	2ZR 003 236-057	671 820 04 56	2KA 006 896-001
1503.400.00	2KA 001 378-041	821-SG001	5DF 009 244-007	000 544 30 47 01	1BL 247 042-157	671 820 04 56	2KA 006 896-007
1503.401.00	2KA 005 049-008	823-BL001	2BM 006 692-011	000 544 33 07	2ZR 003 236-311	7 512 129 00 00	1BL 005 380-011
1503.402.00	2KA 003 389-061	823-BL001	2BM 006 692-011	000 544 37 34	2KA 003 168-021	7 512 129 012 0	1VB 005 444-037
1503.402.00	2KA 003 389-062	823-BL002	2BM 006 692-021	000 544 40 11	2XS 007 841-021	7 512 131 000 0	1BL 005 380-021
1503.402.00	2KA 003 389-068	823-BL002	2BM 006 692-027	000 545 82 26	8JB 850 434-011	7 515 115 000 0	2ZR 002 694-001
1503.403.00	2KA 001 622-001	823-BL003	2BM 006 692-011	000 585 11 03	8XH 002 975-017	7 521 123 000 0	2BA 001 777-021
1503.407.00	2KA 003 168-021	823-BL003	2BM 006 692-017	000 820 04 57	2DA 959 071-172	7 521 138 004 0	9EL 115 800-001
1503.408.00	2KA 005 049-011	823-BL004	2BM 006 692-021	000 820 05 59	1BL 008 193-172	7 521 145 000 0	2BA 003 236-021
1503.408.00	2KA 005 049-017	823-BL004	2BM 006 692-027	000 820 10 20	2BM 008 355-001	7 521 145 000 0	2BA 003 236-027
1503.511.10	1F8 007 560-041	823-BL009	2BM 008 355-007	000 820 10 20	2BM 008 355-007	7 521 146 000 0	2BA 001 240-301
1503.513.00	1FD 003 590-411	823-BL009	2BM 008 355-007	000 820 25 68	2DA 001 240-341	7 521 146 000 0	2BA 001 240-301
1503.527.00	1GD 003 590-701	823-UL 011	2XS 008 479-041	000 820 36 66	9EL 119 544-212	7 521 148 000 0	2BA 002 947-011
1503.541.20	2XS 005 020-041	823-UL 011	2XS 008 479-047	000 820 37 21	2BA 004 119-001	7 534 113 017 0	9GD 100 140-001
1503.541.20	2XS 005 020-047	823-UL001	2XS 005 020-001	000 820 39 66	2AA 003 257-041	7 534 160 000 0	2XS 005 020-011
1503.700.00	8RA 003 326-011	823-UL001	2XS 005 020-002	000 820 39 66	2AA 003 257-047	7 534 160 000 0	2XS 005 020-017
1503.700.00	8RA 003 326-017	823-UL001	2XS 005 020-003	000 820 41 64	2SB 001 423-097	7 534 165 000 0	2NE 003 236-001
1503.700.10	8RA 003 326-041	823-UL012	2XS 008 479-051	000 820 59 56	2NE 001 423-011	7 534 165 000 0	2NE 003 236-008
1503.700.10	8RA 003 326-047	823-UL012	2XS 008 479-057	000 820 75 70	2DA 959 071-037	7 534 177 000 0	2SA 001 638-021
1503.700.50	8RA 003 326-021	823-VL001	2XS 005 020-001	000 820 90 56	2KA 003 389-061	7 534 177 000 0	2ZR 003 236-051
1503.701.00	8RA 003 660-007	823-VL001	2XS 005 020-002	000 820 90 56	2KA 003 389-062	7 534 177 000 0	2ZR 003 236-057
1503.702.00	8RL 002 009-021	823-VL001	2XS 005 020-003	000 820 90 56	2KA 003 389-068	7 534 183 000 0	2XS 005 020-001
1503.704.00	8RL 002 009-021	825-BL002	2BA 005 603-011	000 820 92 03	2KA 001 389-101	7 534 183 000 0	2XS 005 020-002
1503.706.00	8RA 003 326-041	825-BL002	2BA 005 603-017	000 825 06 03	2PF 004 081-001	7 534 183 000 0	2XS 005 020-003
1503.706.00	8RA 003 326-047	825-BL010	2BA 008 221-041	000 826 10 40	2PF 004 081-007	7 534 191 004 0	9EL 141 135-031
1503.743.00	8RB 004 713-001	825-BL010	2BA 008 221-047	000 826 14 41	8RA 003 660-007	7 542 108 000 0	2BA 001 389-101
1503.746.00	2XS 955 031-001	825-BL011	2BA 008 260-001	000 826 18 40	2PS 002 727-001	7 544 111 000 0	2KA 003 389-001
1503.800.00	2SA 001 647-041	825-BL011	2BA 008 260-007	000 826 30 47	8RA 003 326-031	7 544 114 000 0	2KA 001 386-281
1503.801.00	2PF 001 647-031	825-BRL 006	2XA 008 221-021	000 826 30 47	2SA 001 259-751	7 544 119 000 0	2KA 003 389-061
1503.801.00	2PF 001 647-037	825-BRL 007	2XA 008 221-027	000 826 42 47	2SA 001 259-757	7 544 119 000 0	2KA 003 389-062
1503.802.00	2PF 961 167-021	825-BRL 007	2NE 008 221-031	000 827 00 10	2PF 001 259-631	7 544 119 000 0	2KA 003 389-068
1503.804.00	2SA 003 014-051	825-BRL002	2NE 008 221-037	000 827 07 31	5DS 009 602-001	7 544 119 000 0	2JA 001 331-011
1503.805.00	2PF 003 014-071	825-BRL002	2DA 005 603-031	000 827 08 31	9GH 152 654-007	7 552 030 000 0	2JA 004 531-011
1503.811.00	2JA 005 590-001	825-BRL002	2DA 005 603-037	000 827 32 86	9GH 158 051-007	7 553 016 000 0	2JA 004 531-011
1503.817.00	2PF 004 081-007	825-BRL005	2DA 005 603-011	000 997 32 86	9GH 096 532-001	7 556 012 003 0	2AB 004 532-051
1503.905.00	2SA 001 638-021	825-BRL005	2SA 008 405-017	000 998 57 90	9GT 137 236-007	7 556 012 003 0	2AB 004 532-057
1503.906.00	2PF 001 638-011	825-BRL008	2DA 008 136-017	001 544 92 90	9EL 119 544-111	7 556 012 003 0	9XB 136 202-005
1503.907.00	2XS 005 020-001	825-BRL009	2DA 007 541-001	001 544 94 90	9EL 119 544-001	7 740 000 021	9GH 096 532-001
1503.907.00	2XS 005 020-002	825-BRL010	2DA 959 071-737	001 545 04 26	8JB 001 933-031	7.312.018.000.00	6ED 004 778-001
1503.907.00	2XS 005 020-003	825-BRL011	2DA 343 106-011	001 820 05 01	2AB 004 532-051	7.515.115.004.0	9EL 113 928-001
1503.907.01	9EL 132 215-001	825-BRL011	2DA 343 106-017	001 820 05 01	2AB 004 532-057	7.515.116.000.0	2ZR 001 240-351
1503.907.10	2XS 007 841-011	825-BRL012	2DA 343 106-211	001 820 08 58	2RL 007 337-011	7.521.149.000.0	2BM 002 847-021
1503.907.10	2XS 007 841-017	825-BRL012	2DA 343 106-217	001 820 25 21	2BA 003 236-541	7.534.113.000.0	2PF 001 638-011
1503.907.20	2XS 007 841-021	825-BRL012/015	2DA 343 106-211	001 820 39 21	2BM 006 692-011	7.534.118.104.0	9EL 114 401-001
1503.926.00	8GA 002 074-241	825-BRL012/015	2DA 343 106-217	001 820 39 21	2BM 006 692-017	7.534.155.003.0	9DX 119 545-011
1504.012.00	2JA 003 236-357	825-BRL013	2DA 343 106-031	001 820 39 21-00	2BM 006 692-011	7.556.012.002.0	2AB 004 532-051
1504.016.00	2JA 004 531-011	825-BRL013	2DA 343 106-037	001 820 40 21	2BM 006 692-017	7.556.012.000.0	2AB 004 532-057
1504.016.01	9EL 856 010-001	825-BRL014	2DA 343 106-231	001 820 40 21	2BM 006 692-027	HXB 373 820 17 64	2SA 003 236-041
1504.019.00	2SA 001 259-751	825-ET 027	9GT 137 236-007	001 820 40 21	2BM 006 692-027	HXB 373 820 18 64	2DA 003 236-037
1504.019.00	2SA 001 335-011	825-ET002	9EL 107 368-001	001 820 40 21-00	2BM 006 692-027	HXB 373 820 18 64	2DA 003 236-031
1504.032.00	2JA 003 231-001	825-ET007	9EL 107 368-001	001 820 40 21-00	2BM 006 692-027	HXB 373 820 18 64	9EL 119 544-031
1504.032.00	2JA 002 661-001	825-ET008	9EL 111 647-001	001 820 67 21	2BA 001 423-087	10 000000 003884	8GP 008 285-001
1504.037.10	9EL 120 240-011	825-ET009	9EL 122 772-001	001 820 77 01	2JA 006 447-251	N072601024900	8GP 002 067-241
1504.038.00	2JA 003 354-051	825-ET010	9EL 131 420-011				

Manufacturer's no. / HELLA no.

Cross-Reference



Facet	HELLA	Faun	HELLA	Faun	HELLA	Feldbinder	HELLA
14655	8GP 002 068-241	5247 605	1GD 005 700-501	9970-7004770	2SA 001 259-751	004887	8GA 002 071-248
14660	8GP 002 095-241	5247 653	2SE 007 547-041	9970-7004770	2SA 001 259-757	004888	2ZR 001 423-001
14674	8GD 002 078-241	5247 667	2RL 007 017-071	9970-7005086	1G3 005 760-001	004889	2XS 950 071-031
14675	8GM 002 094-121	5247 757	2ZR 997 506-391	9970-7006297	2BM 006 692-011	004890	2NE 001 423-011
14680	8GM 002 094-241	52471-61	2RL 008 181-111	9970-7006297	2BM 006 692-017	004891	2PF 001 259-631
14689	8GP 003 594-241	5247-915	2VA 343 640-117	9970-7006298	2BM 006 692-021	004898	2SD 003 167-021
14690	8GP 003 594-251	5247-916	2VA 343 640-207	9970-7006298	2BM 006 692-027	004899	2SD 003 167-011
14698	8GP 002 068-131	524951	2KA 003 389-061	99707006623	2SD 002 776-231	004910	8RA 002 016-111
14699	8GH 002 857-241	524951	2KA 003 389-062	99707006623	2SD 002 776-237	004911	8RA 002 016-101
14710	8GD 004 772-121	524951	2KA 003 389-068	99707006624	2SD 002 776-241	004912	8RA 003 326-001
14720	8GH 002 473-151	5641 110	9EL 146 887-001	99707006624	2SD 002 776-247	004912	8RA 003 326-002
14731	8GP 002 095-121	5641 282	2SE 007 547-021	99707006701	5KG 007 629-011	004914	2SK 003 567-331
14732	8GD 002 084-151	5641 282	2SE 007 547-027	9970-7010742	2PS 008 645-001	004915	2XS 005 020-001
	Faun	5641 363	2SD 001 685-307	9970-7010742	2PS 008 645-007	004915	2XS 005 020-002
		5641 463	2XD 010 311-001	9970-7011463	2RL 008 060-111	004915	2XS 005 020-003
0090-251	2JA 001 330-001	5641 475	1GM 996 136-192	99707011950	2RL 007 900-511	004916	2XS 005 020-017
0090-251	2JA 001 330-007	5641-374	2KA 959 640-661	9970-7013043	9EL 862 141-001	004916	2KA 001 386-281
0339-992	2BA 002 324-001	5641464	2XD 010 311-011	99707013878	2RL 008 183-011	004917	2SD 001 685-211
0511-591	2BA 002 324-011	5641-476	2SD 344 100-101	99707014602	2VD 007 323-131	004918	2SD 001 685-218
0511-592	2BA 002 324-021	5641561	8JB 004 777-001	99707014603	2VP 007 323-121	004918	9EL 122 772-001
0552-315	2BA 002 652-111	5642 068	1GA 996 188-001	99707014603	2RL 007 551-011	004921	2SE 001 685-221
0552-315	2BA 002 652-117	5642 230	1GA 996 189-001	99707014709	9EL 110 542-001	004938	2SE 001 685-227
0576-427	2BA 002 652-101	5642330	2RL 010 979-001	99707015359	1GA 998 525-001	004938	9EL 113 324-001
0576-427	2BA 002 652-107	5642426	1GA 996 189-031	99707016501	1H3 002 456-032	004938	2SK 003 567-321
1537-807	2JA 003 354-001	6254 93	2XS 955 031-001	99707016583	9BG 990 353-001	004941	9EL 950 315-001
1706 038	8GP 002 068-241	7000-939	2PS 006 717-031	99707016603	9EL 146 838-001	005262	9EL 950 315-031
1706 111	8GH 002 089-251	7000-939	2PS 006 717-037	99707017363	2VD 007 323-141	006791	1NA 007 133-001
1706-036	8GH 002 089-253	7004-770	2SA 001 259-751	99707017364	2VP 007 323-111	006816	8GP 002 095-241
1706-103	8GA 002 071-241	7004-770	2SA 001 259-757	99707018060	2RL 008 183-111	006842	9DF 112 246-001
1706-105	8GP 002 067-241	7005-086	1G3 005 760-001	99707030021	2KA 001 378-001	006869	1NE 002 537-201
1706-109	8GA 002 071-251	7300-981	9EL 856 416-001	99707032790	2XS 340 448-001	006870	9GT 074 132-001
1706-109	8GH 002 090-251	7301 861	9EL 122 689-021	99707034803	2KA 010 278-011	006870	2VP 007 907-031
1706-112	8GH 002 090-253	7470 78	9XD 130 261-001	99707034803	2KA 010 278-017	006870	2VP 007 907-037
1710-120	2SE 002 578-701	7482 62	1GA 007 506-001	9970 7300991	9EL 856 416-001	006870	2VP 007 907-047
1710-120	2SE 002 578-707	7482 62	1GA 007 506-002	9970 7301861	9EL 122 689-021	006870	2VP 007 907-047
1710-141	2BA 001 227-201	7723 582	1GA 007 506-007	99707302238	1G3 135 211-011	007101	1GA 003 470-031
1710-145	2KA 001 389-101	7723 802	2XS 005 020-077	99707305610	1AB 003 177-001	007107	8GA 002 071-121
1710-168	2BA 002 324-021	7723 803	2VP 003 567-111	99707723461	1VB 005 444-037	007107	8GA 002 071-123
1710-201	2BA 003 022-001	7723 803	2VP 003 567-121	99707723462	2XS 005 020-001	007108	8GM 002 091-121
1710-218	2KA 003 389-061	7723-461	1KB 003 177-061	99707723582	2XS 005 020-002	007108	8GM 002 091-241
1710-218	2KA 003 389-062	7730-968	8HG 006 294-041	99707723582	2XS 005 020-003	007109	8GA 002 073-121
1710-218	2KA 003 389-068	7751 228	1G3 005 760-011	99707723582	2XS 005 020-077	007109	8GA 002 073-123
1710-312	2XS 950 071-031	7751-492	2PF 006 679-007	99707723637	2XS 005 020-081	007111	8GA 002 071-251
1710-313	2XS 005 020-001	8412-667	2SD 001 699-061	99707723802	2VP 003 567-111	007111	8GA 002 071-258
1710-313	2XS 005 020-002	8412-695	2BE 003 014-251	99707723803	2VP 003 567-121	007112	8GA 002 073-241
1710-313	2XS 005 020-003	8412-695	2BE 003 014-257	99707723803	2VP 003 567-127	007112	8GA 002 073-248
1710-84	2BA 001 208-001	8413-122	2JA 003 231-001	9970-7730539	2BA 996 027-001	007113	8GH 002 090-251
1711-003	8RA 002 016-111	8464 789	2PF 003 014-071	9970-7751204	9XD 130 261-001	007113	8GH 002 090-253
1711-033	8RA 002 016-121	8464-239	2PS 004 361-001	9970-7751228	1G3 005 760-011	007113	8GH 002 090-258
1712 145	1AB 001 100-001	8464-239	2PS 004 361-007	9970-7751280	8HG 006 294-021	007123	2KA 003 389-001
1712-099	1G9 001 523-021	8464-953	2AB 004 532-051	9970-7751492	2PF 006 679-007	007136	8GM 002 092-121
1712118	2ZR 001 423-001	8464-953	2AB 004 532-057	9970-7751917	2SE 001 685-201	007137	8GM 002 092-241
1712-140	2ZR 003 014-091	8467 134	9EL 116 907-001	9970-7758097	2XS 950 071-031	007147	8GH 002 857-241
1794-539	9EL 146 491-001	8467 201	9BG 121 587-031	9970-7764767	2XW 007 146-001	007151	2TF 001 259-761
1795-838	9DF 112 246-001	8467 201	9BG 121 587-037	99708007784	8GJ 002 525-251	007154	2XS 005 020-001
1836 319	2TJ 001 633-211	8467-024	9EL 110 542-001	99708102799	8GH 002 857-241	007154	2XS 005 020-002
3171-1060	8RA 002 016-121	8475-135	2SE 001 685-201	99708412667	2SD 001 699-061	007154	2XS 005 020-003
3360080100	2BA 965 039-141	8475-319	1NA 002 608-021	99708412674	2BA 003 022-001	010684	8JA 003 526-001
3360080100	2BA 965 039-147	9970 0030229	8GP 002 067-241	99708412675	2SE 001 699-071	010691	8GJ 002 525-131
3365-0080100	2BA 965 039-141	9970 5467158	9XR 854 840-001	99708412692	2BA 003 734-061	010691	8GJ 002 525-136
3365-0080100	2BA 965 039-147	9970 701 6350	8GS 007 949-261	99708412742	1AG 003 434-137	010698	8GJ 002 525-151
4158-831	2SD 001 685-231	9970 7015510	9GH 993 984-001	99708413122	2JA 003 231-001	010698	8GJ 002 525-258
4158-831	2SD 001 685-232	9970 7015528	99708413715	9970-8436830	6ED 708 919-001	011283	2SK 003 567-321
5171 783	1GD 996 193-001	9970 7016602	1GA 007 506-431	99708464300	9EL 115 003-055	011285	2SL 003 567-311
5171 925	2RL 010 979-001	9970 7016999	9EL 146 887-001	99708464300	2XS 005 020-001	011286	2SD 001 699-061
5171547	1GM 996 136-192	9970 7018848	2ZR 997 506-391	99708464300	2XS 005 020-002	011287	2SD 001 699-511
5217-878	2SD 001 685-307	9970 7021893	2SA 962 964-091	99708464300	2XS 005 020-003	011288	2SE 001 699-071
5221-112	2XS 005 020-081	9970 7021899	9GT 963 129-001	99708464301	2XS 005 020-011	011291	2SD 003 184-031
5231-056	1GA 005 060-001	9970 7032067	9XJ 340 882-001	99708464301	2XS 005 020-017	011291	2SD 003 184-037
5231-056	1GA 005 060-041	9970 7032789	2XS 340 448-011	99708464788	2PF 003 389-037	011292	2SD 003 184-041
5231-056	9XD 130 261-001	9970 7034832	2PF 959 590-202	9970-8464789	2PF 003 014-071	011292	2SD 003 184-047
5231-598	2SD 003 184-031	9970 7034832	2PF 959 590-207	9970-8467024	9EL 110 542-001	011293	2SE 002 578-701
5231-598	2SD 003 184-037	9970 7307671	9EL 950 315-001	9970-8467134	9EL 116 907-001	011293	2SE 002 578-707
5231-599	2SD 003 184-041	9970 7308166	9EL 950 315-031	9970-8475136	2BA 003 014-011	011294	2SE 002 578-707
5231-599	2SD 003 184-047	9970 7799875	2SB 964 169-531	9970-8476344	2XS 955 031-001	011294	2SE 002 578-707
5240 127	2ZR 003 236-051	9970 7799875	2SB 964 169-537	99708519965	2SA 003 057-021	011295	2KA 001 386-231
5240 127	2ZR 003 236-057	9970 7799876	2BA 964 169-501	99708520062	2PF 003 057-041	011296	2KA 001 386-281
5240 929	8HG 006 294-051	9970 7799876	2BA 964 169-507	9970-8520690	9EL 117 330-001	011308	8GP 003 594-251
5240-103	2RL 007 550-011	9970 7799877	2ZR 964 169-511	9970-8520691	9EL 117 330-011	011308	8GP 003 594-258
5240-495	2BA 003 236-321	9970 7799877	2ZR 964 169-517			011389	2SE 003 167-031
5240-496	2SA 003 236-341	9970 8412748	1G5 003 241-071	Feldbinder	HELLA	011424	8HG 002 240-021
5240-497	2DA 003 236-331	9970 8464953	2AB 004 532-051	001225	8GH 002 090-133	011467	2SK 003 567-651
5240-498	2ZR 003 236-311	9970 8464953	2AB 004 532-057	001225	8GH 002 090-136	011468	2SK 003 567-661
5240-499	2NE 003 236-301	9970 8467201	9BG 121 587-031	001296	8GP 002 068-121	011502	2SD 004 431-011
5240-514	2SA 961 167-011						



Manufacturer's no. / HELLA no.

Cross-Reference

Feldbinder	HELLA	Fendt	HELLA	Fendt	HELLA	Fendt	HELLA
066714	8JB 004 777-001	3 385 820 M1	2JA 001 357-002	F 231 902 140 040	8GA 002 074-121	G931.901.112.020	1GM 996 134-271
066714	8JB 004 777-002	3 385 821 M1	8GM 002 091-131	F 231 902 140 060	8JB 850 434-011	G931.901.113.010	1GM 996 134-106
066716	8JD 008 151-011	3 389 596 M1	8RA 004 412-021	F 231 902 140 080	9EL 854 912-001	G931.901.220.030	2KA 004 331-107
066719	9EL 150 966-001	3 389 964 M91	2VA 997 113-011	F 250 900 020 010	2SA 001 634-121	H 737 900 020 010	8RA 009 001-031
066887	2VD 007 500-091	3 405 150 M91	8JA 001 909-001	F 312 901 110 040	1GA 998 525-001	H 737 900 020 010	8RA 009 001-037
067568	2TA 964 169-061	3 476 059 M91	2BE 003 014-251	F 716 900 020 030	9GH 126 647-011	H 922.500.410.020	8RW 341 235-007
067568	2TA 964 169-067	3 476 059 M91	2BE 003 014-257	F 716 900 020 040	9EL 113 324-001	H 931.901.020.080	5DS 009 602-011
069542	2XW 007 146-011	3 708 032 M91	2SD 002 582-021	F 737 900 020 010	8GD 002 078-121	V 310 851 00	9GH 906 532-001
070134	9EL 092 435-011	3 708 032 M91	2SD 002 582-027	F 930 900 020 040	9EL 990 354-021	V 327 670 00	9FF 126 444-001
1002220	4RD 933 332-041	3 708 059 M91	2BE 003 182-091	F 930 900 020 060	9EL 990 354-041	V 649 791	8JB 001 943-001
1003273	1GA 007 506-021	3 708 060 M91	2BE 003 182-101	F 930 900 020 070	1AB 990 335-111	V SH2 638	8GP 002 066-121
100967	2DA 003 236-031	3 713 137 M1	1AB 006 213-001	F 930.900.020.010	1A3 002 850-031	V30181410	1GB 996 213-511
100967	2DA 003 236-037	3 907 271 M1	8GP 003 594-121	F 930.900.020.050	9EL 990 354-031	V31547310	1AB 006 277-127
100967	2SA 003 236-041	3 907 271 M1	8GP 003 594-541	F 930.900.020.120	8JA 990 065-001	V32547500	9KD 116 415-005
100967	2SA 003 236-048	3 907 271 M1	8GP 003 594-543	F 930.900.111.010	1GA 990 305-001	V692470	2JA 001 330-007
1011107	2VD 007 500-091	3102003M1	8RA 003 326-001	F 931 901 020 100	9GH 145 943-012	V692470	2JA 001 330-007
1011314	2VD 007 500-201	3102003M1	8RA 003 326-002	F 931 901 020 160	9XB 152 977-001	X 671 305 800 000	8GA 007 997-081
1011470	2KA 006 896-001	3105050M1	9EL 997 453-001	F 931.901.020.020	9GD 159 740-007	X 671 306 200 000	8GA 002 071-121
1014493	1GA 005 060-001	3539335M92	4RA 933 791-061	F 931.901.111.010	5DV 008 855-001	X 671.306.000.000	8GM 002 092-121
1014533	2KA 003 389-211	3906604M1	4RA 933 791-061	F 931.901.111.010	5DV 008 855-007	X 671.306.500.000	8GA 002 071-131
1014533	2KA 003 389-217	4 352 675 M2	1K0 247 043-167	F 931.901.111.020	8KB 990 299-241	X 671.306.500.000	8GA 002 071-133
1014809	2NE 003 315-011	4 352 924 M2	1BL 247 042-217	G 210.902.113.010	1GM 996 134-061	X 825 282 160	2BA 001 259-618
1017725	8HG 006 294-091	4287182M1	1K0 008 191-011	G 210.902.113.010	1GM 996 134-321	X 825 282 160	2BA 001 259-618
1019501	1GA 006 991-091	4287182M1	1K0 008 191-017	G 210.902.140.020	2RL 007 551-001	X 825 282 160 000	2BA 001 259-618
1024764	2SA 003 014-051	44 900 770	1GA 998 532-011	G 246 900 020 010	1AB 006 213-001	X 825 282 160 010	2BA 001 259-618
1026287	2SA 003 057-021	45 060 045	1G5 003 241-021	G 246 900 020 010	1AD 996 018-651	X 825 282 160 010	9EL 088 150-001
1032944	9EL 134 296-041	45 060 045	1G5 003 241-071	G 246 900 020 040	1AB 006 213-001	X 825 283 225 000	8GP 002 095-121
1034492	2SD 001 680-271	45 084 700	1GA 998 522-011	G 246 900 020 040	1AD 996 018-651	X 825 283 231 000	8GP 002 066-121
1034493	2SD 001 680-281	5 017 952 M1	2RL 007 337-001	G 260 900 020 020	1AL 009 998-001	X 825 283 232 000	8GP 002 068-121
1036030	1GA 007 506-081	6 255 951 M1	8GH 005 635-121	G 294 900 110 010	1GB 006 213-111	X 825 283 232 000	8GP 938 026-001
1043552	1GD 005 700-501	6 501 400 001	2DA 008 136-011	G 294 900 110 010	1GB 006 213-117	X 825 283 232 000	8GD 002 078-221
1043596	2BA 980 607-201	6 539 002 121 00	8RA 002 014-281	G 294 900 110 010	1GD 996 018-541	X 825 283 232 000	8GA 006 841-123
1046850	2RL 007 017-071	7 113 003 4	8HG 002 240-021	G 312 900 110 010	1GA 007 506-081	X 825 283 232 000	8GA 006 841-123
1053778	2XM 004 444-011	7 113 010 1	8HG 002 240-031	G 312 900 110 010	1GA 998 522-011	X 825 283 232 000	8GH 006 357-001
1054837	2ZR 997 506-391	7 190 439 5	9SD 015 675-001	G 312 900 111 030	1GA 998 522-011	X 825 283 232 000	8GH 007 157-126
1055853	2DA 959 071-737	7 190 439 6	9SD 024 183-001	G 312 900 113 020	1GB 996 991-051	X 825 283 232 000	8GH 007 157-126
1058271	8GA 006 841-241	7 190 439 7	9DR 060 567-001	G 312 900 114 042	1GB 996 991-051	X 825 283 232 000	8GS 007 949-261
1063471	2JA 007 373-107	7 190 439 8	9FF 090 500-001	G 312 901 110 020	8HG 990 003-001	X 825 283 232 000	8GS 009 028-111
1064095	9XD 130 261-001	7 779 357 03	2PF 001 634-101	G 334 900 111 010	1GA 007 506-081	X 825 283 248 000	8GJ 002 525-131
1068243	1G3 005 760-001	718.970.010.010	9DF 130 261-001	G 380 902 110 010	1GA 998 522-011	X 825 283 248 000	8GJ 002 525-136
1069471	9DX 119 545-011	8 429 000 200 50	9DF 198 241-002	G 380 902 110 020	1GA 005 060-041	X 825 283 253 000	8GP 002 067-121
1074857	2SD 344 100-101	8 870 008 7	2SB 003 018-031	G 380 902 110 020	1GA 998 522-011	X 825 283 253 000	8GP 002 067-123
1075458	1GM 996 136-192	8 890 016 8	9EL 111 647-001	G 385 901 020 010	1AA 004 109-021	X 825 283 254 000	8GP 002 067-121
1079101	9EL 134 296-051	8 890 016 9	9EL 107 368-001	G 524 900 115 020	1GA 007 506-081	X 825 283 254 000	8GP 002 067-123
1085218	2VP 340 961-011	8271970	8GA 002 071-251	G 530 811 440 020	2BA 011 172-011	X 825 283 277 000	8GA 006 841-123
1085219	2VP 340 961-021	8271970	8GA 002 071-258	G 530 811 440 020	2BA 011 172-017	X 825 283 277 000	8GA 006 841-123
1085227	8XS 340 092-011	A CV0 271 630	2SD 343 130-011	G 530 811 440 030	2PF 011 172-111	X 825 283 286 000	8GH 002 990-133
1085228	8KA 340 818-011	A CV0 271 640	4DN 309 492-101	G 530 811 440 030	2PF 011 172-117	X 825 283 286 000	8GH 002 990-136
1085230	8KA 340 842-001	A G63 008 8	2ZR 965 039-337	G 530 900 020 020	2DA 343 800-077	X 825 283 291 000	8GM 002 091-131
1085243	2PG 008 645-331	AG630044	8RA 343 160-022	G 530 901 020 050	2SB 008 982-367	X 825 283 299 000	8GA 002 073-121
1085244	8KA 340 859-011	AG630044	8RA 343 160-027	G 530 901 020 060	2BA 008 982-347	X 825 283 299 000	8GA 002 073-123
1085246	8HG 340 489-001	AG630085	2SD 343 130-157	G 530 901 020 100	2BE 010 102-001	X 825 283 480 000	8GS 009 028-111
1086223	2ZR 996 188-061	AG630086	2SD 343 130-167	G 530 902 020 050	2ZR 343 130-041	X 830 108 003 5010	9EL 108 435-001
1086259	2VP 340 961-111	AG630087	2NE 965 039-327	G 530 902 020 050	2ZR 343 130-047	X 830 108 035 010	9EL 108 435-001
1086260	2VP 340 961-121	AG630089	2BM 008 355-017	G 530 902 110 010	1G0 996 276-187	X 830 160 010 060	9FF 085 642-001
1086266	2PS 008 645-301	AG630090	2BE 343 130-411	G 530 902 112 010	1G0 996 176-041	X 830 160 010	1AA 004 109-021
1086267	2PS 008 645-361	AG630090	2BE 343 130-417	G 530 902 220 010	2KA 010 278-421	X 830 160 010 010	1AA 127 473-015
1086268	9HV 340 812-007	AG630116	2SB 343 130-027	G 530 902 021 060	2KA 343 130-577	X 830 160 038 010	1A5 118 740-001
1086269	9XX 340 870-007	AG630543	1G0 996 176-671	G 530 900 021 080	2BA 343 130-587	X 830 160 039 000	1AB 003 177-001
1086272	9XX 340 879-001	B 000 510 008	2XT 008 929-001	G 530 900 112 030	1G0 996 476-031	X 830 160 100	1GD 003 690-287
1086273	9XX 340 882-001	B 000 510 008	2XT 008 929-007	G 530 900 212 010	2XS 950 071-031	X 830 160 100 000	1GD 003 690-287
1087068	5DS 009 552-001	D 267 329 36	9KD 116 415-005	G 716 900 020 090	2SD 001 685-317	X 830 160 101 130	1GA 006 876-001
1087074	2VP 340 960-121	D 287 613 43	1G3 005 760-001	G 737 900 020 050	2BA 009 001-001	X 830 180 001	2BA 002 324-011
1087077	2VP 340 960-111	D 287 817 28	1GA 998 532-011	G 737 900 020 050	2BA 009 001-007	X 830 180 002	2BA 002 324-021
1087294	8KA 340 843-021	D 449 009 90	2RL 008 965-001	G 737 900 020 060	2SB 009 001-061	X 830 180 015 010	9EL 118 633-001
1088302	9XX 340 884-001	D 450 002 68	2PS 006 717-031	G 737 900 020 060	2SB 009 001-067	X 830 180 020	2XW 003 146-001
1088303	9XX 340 881-001	D 450 002 68	2PS 006 717-037	G 737 900 020 070	2BA 009 001-431	X 830 180 030	2JA 001 330-001
1089823	1GA 996 188-001	D 450 502 00	2RL 007 550-021	G 737 900 020 130	2SB 009 001-401	X 830 180 030	2JA 001 330-007
1090402	2JA 343 606-011	D 450 752 00	4RA 965 400-001	G 737 900 020 130	6NM 007 282-221	X 830 180 030 000	2JA 001 330-001
1090402	2JA 343 606-017	D 450 775 00	2BA 001 277-021	G 737 900 110 030	1GA 996 192-157	X 830 180 030 000	2JA 001 330-007
1090788	8KB 990 299-011	D 450 776 00	1BA 001 277-011	G 737 900 110 031	1GA 996 192-157	X 830 180 032	2BE 003 014-251
1090836	8KA 340 815-001	D 450 800 02	1G3 141 019-011	G 737 900 020 100	1AL 010 820-021	X 830 180 032	2BE 003 014-257
1092216	8KA 340 859-001	D 450 800 05	2PG 006 717-021	G 842 900 020 060	6NM 007 282-221	X 830 180 032 000	2BE 003 014-257
1093554	2SD 959 050-401	D 450 800 07	2PG 006 717-027	G 842 900 020 100	1AL 010 820-067	X 830 180 032 000	2BE 003 014-257
1094356	2SD 340 685-051	D 450 809 07	2BA 002 652-101	G 842 900 020 101	1AL 010 820-067	X 830 180 032 010	9EL 115 003-055
1094359	2KA 010 278-081	D 450 813 00	2BA 002 652-107	G 916 901 020 010	1GA 996 020-001	X 830 180 033	2PF 001 648-161
1094391	8JA 746 184-022	D 450 809 00	8GM 002 092-121	G 930 900 020 010	1AB 00		

Manufacturer's no. / HELLA no.

Cross-Reference



Fendt	HELLA	Fiat	HELLA	Ford	HELLA	Ford	HELLA
X 830 180 080	2PS 002 727-001	41822954	2KA 003 389-062	1 505 147	2KA 001 622-001	98CT13K354BA	2BM 006 692-027
X 830 180 080	2PS 004 361-001	41822954	2KA 003 389-068	1 516 578	2SD 001 688-171	9HB15K201BA	2NE 001 423-011
X 830 180 080	2PS 004 361-007	41933709	2ZR 003 030-171	1 516 579	2SD 001 688-141	9SX 863 323-001	8K 863 323-001
X 830 180 085	2NE 002 985-001	42013057	2SE 003 167-031	1 530 665	6ED 004 778-011	A91A 1X3550AA	2KA 004 525-001
X 830 180 091 000	2BE 003 347-001	42013058	2SD 003 167-021	1 536 477	1A6 002 395-071	AC46 13776AA	2JA 006 447-087
X 830 180 095	2BE 003 347-001	42013059	2SD 003 167-011	1 536 477	1A6 002 395-077	E3NN13707AA	2JA 003 231-011
X 830 180 095 000	2BE 003 347-001	42013060	2SE 003 167-041	1 568 199	2SA 001 259-751	V1C4115592AA	1G4 003 470-031
X 830 180 095 010	9EL 120 224-001	42024986	2SE 001 685-201	1 568 199	2SA 001 259-757	V1C4415592AA	1G4 003 470-051
X 830 180 147 001	2X5 005 020-001	42024987	2SD 001 685-211	1 582 913	2AA 001 200-151	V1C4415637AA	1TJ 001 633-211
X 830 180 152	2PS 002 727-001	42024987	2SD 001 685-218	1 583 532	6ZE 001 759-051	V1C4613465AA	8GH 006 294-011
X 830 180 152 000	2PS 002 727-001	42025923	2SE 002 578-701	1 657 858	6ZE 001 759-071	V1C4613464AA	8GH 002 090-251
X 830 180 162	2PS 964 295-001	42025923	2SE 002 578-707	1 660 382	2BA 003 022-021	V1C4613465AA	8GH 002 090-253
X 830 180 162	2PS 964 295-007	42046008	2XW 002 897-051	1 660 431	2AA 001 200-151	V1C4613465AA	8GH 002 090-258
X 830 180 165	2PS 962 964-031	42046397	8RA 003 326-011	1 813 545	8RA 002 016-121	V76HB15442BB	2PF 003 057-041
X 830 180 165	2PS 962 964-037	42046397	8RA 003 326-017	1 815 335	9EL 043 137-001	V78GG 15A587AA	6ZE 001 759-051
X 830 180 172	2KA 004 331-061	42047225	2NE 003 236-001	1 838 694	8RA 002 023-001	V82VG 15A587AA	6ZE 001 759-071
X 830 180 172	2KA 004 331-067	42047225	2NE 003 236-008	2 000 050	2BA 003 022-037	V87BG 13774AA	2JA 001 357-002
X 830 180 180	2SD 004 460-011	42047226	2BA 003 236-321	2 967 157	9GT 074 132-001	V92VG13K309AB	2BA 003 022-037
X 830 180 180	2SD 004 460-017	42047227	2DA 003 236-331	22 7658	2SB 003 018-031	V93GG 18213AA	8JB 004 777-001
X 830 180 180 000	2SD 004 460-011	42047228	2SA 003 236-341	2T1A13K767AC	1K0 008 191-021	V93GG 18213AA	8JB 004 777-002
X 830 180 180 000	2SD 004 460-017	42047229	2ZR 003 236-311	2T1A13K767AC	1K0 008 191-027	V95CT13380AA	8RA 003 326-011
X 830 180 181	2SD 004 460-001	42225071	2PS 006 717-031	3 227 655 0	2SD 003 184-041	V95CT13380AA	8RA 003 326-017
X 830 180 181 000	2SD 004 460-001	42225071	2PS 006 717-037	3 227 655 0	2SD 003 184-047	V95CT13464AA	2SK 003 567-321
X 830 180 182	2SK 004 460-041	42304484	2BA 003 236-021	3 959 698	1A3 005 649-007	V95CT13465AA	2SK 003 567-331
X 830 180 183	2SK 004 460-031	42304484	2BA 003 236-027	3 961 516	2BE 002 582-031	V95CT13K309AA	2BM 009 320-807
X 830 180 183	2SK 004 460-037	42304485	2SA 003 236-041	3 989 293	9EL 112 743-001	V9713K464AA	2SA 001 259-751
X 830 180 190	2DA 007 421-001	42304485	2SA 003 236-048	3 989 315	9EL 112 741-001	V9713K464AA	2SA 001 259-757
X 830 180 190	2DA 007 421-007	42304486	2DA 003 236-037	3 991 017	9EL 112 744-001	V97C13K464AA	2SA 001 259-757
X 830 180 193	8KA 146 751-007	42304487	2NE 003 236-008	30 884 017	2RL 008 064-101	V98BG13774AA	2JA 001 364-001
X 830 180 193	2VA 007 502-011	42304487	2NE 003 236-008	32 009 011	8GH 002 090-253	XSAV18213AA	8JB 004 777-001
X 830 180 195	2VA 007 502-011	42304488	2ZR 003 236-051	32 009 011	8GH 002 090-258	XS4V18213AA	8JB 004 777-002
X 830 180 195 000	2VA 007 502-011	42304488	2ZR 003 236-057	32 010 159	8GA 002 073-123		HELLA
X 830 180 195 000	2VA 007 502-011	42317738	2ZR 003 236-051	32 010 159	8GA 002 073-123	0600320	8GA 002 071-121
X 830 180 196	2VP 007 502-041	42317738	2ZR 003 236-057	32 230 100	2XW 003 146-001	0600320	8GA 002 071-123
X 830 180 196 000	2VP 007 502-041	42331327	2JA 003 660-007	32 276 583	2SB 003 018-031	0600320	8GA 002 073-121
X 830 180 197	2VA 007 502-117	42340069	8RA 001 357-002	32 276 628	1S3 001 117-041	0600320	8GA 002 073-123
X 830 180 198	2VF 007 502-127	42460351	9EL 110 536-001	32 280 252	1G5 003 241-021	0600560	2AA 003 257-001
X 830 180 200	2DA 008 136-007	42487086	9EL 113 324-001	3C46 13D144 AA	8JD 156 150-807	0600560	2AA 003 257-041
X 830 180 200	2SD 003 167-021	42530460	9EL 146 491-001	3C4613K005AA	1BL 008 193-011	0600560	2AA 003 257-042
X 830 180 200 020	9GD 087 883-355	42531998	9EL 115 830-001	3C4613K005AA	1BL 008 193-017	0600560	2AA 003 257-047
X 830 180 201	2SE 003 167-031	445502	2KA 003 168-021	3C4613K005BA	1K0 008 191-021	0600565	8GP 002 066-121
X 830 180 205	2X5 008 479-001	4474443	1A6 002 395-031	3C4613K005BA	1K0 008 191-027	0601690	2PS 962 964-031
X 830 180 205	2X5 008 479-007	44902454	2KA 001 389-101	3C4613K368AA	2BA 008 221-001	0601690	2PS 962 964-037
X 830 180 206	2X5 008 479-011	44906471	2BE 003 014-251	3C4613K368AA	2BA 008 221-007	0601691	9GD 963 281-001
X 830 180 206	2X5 008 479-017	44906471	2BE 003 014-257	3C4613A387AA	9GT 137 236-007	0602540	2TM 964 295-091
X 830 180 207	2DA 007 858-037	4833768	2SA 001 259-751	3C4613B390AA	2BA 008 221-001	0602540	2TM 964 295-097
X 830 180 208	8KA 146 751-007	4833768	2SA 001 259-757	3C4613B390AA	2BA 008 221-007	0602850	1NL 007 186-021
X 830 180 250	2ZR 003 236-051	4961372	2SD 001 680-281	3C4613D138AA	6NM 007 231-037	0602850	1NL 007 186-027
X 830 180 250	2ZR 003 236-057	4961372	2SE 001 680-291	3C4613D140AA	8GH 007 157-241	0602860	9GH 147 009-007
X 830 180 250 000	2ZR 003 236-051	5154298	8JA 003 526-001	3C4613D140AA	8GH 007 157-248	0602970	2DA 007 421-001
X 830 180 250 000	2ZR 003 236-057	51542980	8JA 003 526-001	3C4613D141AA	8GP 002 067-241	0602970	2DA 007 421-007
X 830 190 050	8RL 002 009-021	593628	2SD 001 693-011	3C4613D146AA	1BL 008 193-011	0603080	2KA 005 049-008
X 830 230 554 000	8JA 900 065-001	60657892	2DA 007 421-027	3C4613D146AA	1BL 008 193-017	0604160	2BM 008 355-001
X 830 250 024 000	4RA 003 530-001	638230	2PS 002 727-001	3C4613D146BA	1K0 008 191-021	0604160	2BM 008 355-007
X 830.160.040	1AA 004 109-001	71130013	2KA 001 389-101	3C4613D146BA	1K0 008 191-027	0604370	2XT 008 929-001
X 830.160.065.020	1A3 900 016-011	71130027	2AA 001 200-001	3C4613K046AA	9GH 152 654-007	0604370	2XT 008 929-007
X 830.180.063.010	8GH 002 089-133	71130034	8HG 002 240-021	3C4613N361AA	8GA 006 841-241	0604640	2ZR 343 130-041
X 830.180.063.010	8GH 002 089-136	71130046	2BA 001 259-611	3C4615B222AA	9GH 158 051-007	0604640	2ZR 343 130-047
X 830.180.147.000	2X5 005 020-001	71130046	2BA 001 259-618	3C4615B224AA	1N0 008 582-011	0604650	2NE 343 130-031
X 830.180.147.000	2X5 005 020-002	71130101	8HG 002 240-031	3C4615B224AA	1N0 008 582-017	0604650	2NE 343 130-037
X 830.180.147.000	2X5 005 020-003	71300027	2AA 001 200-001	3C4615K201AA	1N0 008 582-011	0604660	2BA 343 130-051
X 830.190.055	8RA 002 023-001	71403699	8XS 113 389-001	3C4615K201AA	1N0 008 582-017	0604660	2BA 343 130-057
X 830.190.055.000	8RA 002 023-001	71701052	2AB 004 532-001	3S5115B504AA	2ZR 008 221-157	0604670	2SB 343 130-027
X 840 070 251	2JA 001 364-001	71904420	2BE 003 014-251	5 026 651	2KA 004 525-001	0604680	2PS 964 295-001
X825283262	8GA 006 841-121	71904420	2BE 003 014-257	5C46 13N429 AA	1G4 003 470-031	0604680	2PS 964 295-007
X825283263	8GA 006 841-123	79069588	2BA 002 652-111	5C46 13N429 AA	8GH 002 090-251	0604690	8RA 009 001-037
X825283263	8GD 002 078-121	79069588	2BA 002 652-117	5C46 13N429 AA	8GH 002 090-253	0604690	8RA 009 001-037
X830180122	2PF 964 295-257	79069589	2BA 002 652-121	5C46 13N429 AA	8GH 002 090-258	0604810	8GA 002 073-121
X830180207	2DA 007 858-037	79069589	2BA 002 652-127	5C46 13N4299AA	1G4 003 470-031	0604810	8GA 002 073-123
X830180207	2DA 343 800-001	8119043	2KA 004 525-001	5NN13N302A	9EL 043 137-001	0605000	2SB 965 039-051
X830180207	2DA 343 800-007	8168785	8JA 003 526-001	5NN13N365A	9EL 088 538-001	0605000	2SB 965 039-057
X830180209	2DA 343 800-057	81812945	9EL 135 266-001	5NN13N366A	9EL 088 525-001	0605100	1BL 008 193-011
X830180220	2PG 964 295-367	81813545	8RA 002 016-121	5NN13N370A	2BE 001 259-061	0605100	1BL 008 193-017
X830180307	2NE 344 610-007	81815335	9EL 043 137-001	6 044 355	2PF 001 648-171	0605110	1K0 008 191-021
X830180311	2PS 009 226-067	81817350	8JA 001 930-001	6 048 873	9GH 116 966-011	0605110	1K0 008 191-027
X830180312	9GT 186 597-007	81838694	8RA 002 023-001	6 050 578	4RA 965 400-001	0605120	1N0 008 582-011
X830180209	2DA 343 800-057	83931521	8GH 002 089-133	6 059 235	4RA 965 400-001	0605120	1N0 008 582-017
Y 252 702 0	2BA 003 022-021	83931521	8GH 002 089-136	6 083 293	8JA 003 526-001	0605130	9GH 152 654-007
Y 252 702 4	2SD 003 184-031	83952724	8GA 002 071-131	6 134 866	2PF 001 648-171	0605140	9GH 158 051-007
Y 252 702 4	2SD 003 184-037	83952724	8GA 002 071-133	6ED 004.778-011	6ED 004 778-011	0605150	2BA 008 221-001
Y 252 702 7	2SD 003 184-041	83959698	1A3 005 649-007	7 384 342 A	2BA 003 014-011	0605150	2BA 008 221-007
Y 252 702 7	2SD 003 184-047	83961516	2BE 002 582-031	7 384 349	2SB 003 014-151	0605160	9GT 137 236-007
Y 650 000 2	9EL 118 701-001	83985986	8GD 002 078-121	7 384 395	8RA 002 020-001	0605180	8GP 002 067-241
Y 650 000 2	9EL 118 701-001	83989283	9EL 112 741-001	7 384 395	8RA 002 020-002	0605190	8GD 002 078-248
		83989315	9EL 112 743-001	73 790 027	9FF 090 500-001	0605190	8GD 002 078-248
		83989780	1A3 002 850-031	73 843 372	1S0 001 430-011	0605200	8GA 002 073-248
		84037090	2SE 002 578-701	73 843 474	2SB 001 259-261	0605210	8GA 002 073-248
		84037090	2SE 002 578-707	73 843 485	2SB 001 673-002	0605210	8GA 006 841-241
		88700084	2BA 001 248-001	73 843 510	2SD 002 776-241	0605220	



Manufacturer's no. / HELLA no.

Cross-Reference

Frankia	HELLA	Frankia	HELLA	Fritzmeier	HELLA	Fruehauf	HELLA
0605820	2PS 964 295-067	600143	8GD 002 078-121	224902	2SD 343 910-017	L-SX-0032-002	8GM 002 092-241
0605820	2PS 964 295-081	600144	8GD 002 078-241	225 373	2JA 009 037-027	L-SX0032-007	8GM 002 091-261
0605825	2PS 964 295-051	600147	8GD 002 078-248	225 375	2SD 343 910-027	L-SX0032-009	8GM 002 091-251
0605825	2PS 964 295-057	600147	8GH 002 090-133	226 107	1G0 996 176-131	L-SX0036-001	8RA 002 020-001
0605990	8RA 343 160-002	600147	8GH 002 090-136	226 107	1G0 996 176-137	L-SX0036-001	8RA 002 020-002
0605990	8RA 343 160-007	600154/1	8GJ 002 525-131	226 108	1G0 996 176-141	L-SX0049-003	8GA 002 073-251
0607700	1NL 008 090-327	600154/1	8GJ 002 525-136	226 109	1G0 996 176-041	L-SX0050-003	8GA 002 071-271
0607710	9AH 161 786-017	600156	8GM 002 092-121	226 110	1AL 009 998-001	L-SX0081-001	2PG 004 361-011
0607830	1NO 010 294-001	600159	8GM 002 092-241	226 112	8JB 850 434-011	L-SX0081-001	2PG 004 361-017
0607940	1NO 010 294-011	600161	8GH 007 157-121	226 113	9GH 096 532-001	L-SX0117-888	2SD 003 167-011
0608100	2PS 009 226-021	600161	8GH 007 157-126	226 122	2JA 343 570-041	L-SX0118-801	2SE 003 167-041
0608100	2PS 009 226-027	600162	8GH 007 157-241	226 269	2JA 343 606-011	L-SX0141-003	8GP 003 594-251
0608110	2PS 009 226-077	600162	8GH 007 157-248	226 269	2JA 343 606-017	L-SX0161-001	2SD 001 685-231
0608180	1BL 247 042-177	600165	8GP 002 067-121	226 271	8GA 006 841-241	L-SX0161-001	2SD 001 685-232
0608190	1K0 247 043-127	600165	8GP 002 067-123	227259	2AB 004 532-001	L-SX0221-001	2X5 955 031-001
0608200	1NL 008 090-031	600168	8GP 002 067-241	227284	2ZR 997 506-391	L-SX0311-002	1GA 007 506-011
0608200	1NL 008 090-037	600174	8GM 002 068-131	227299	2JA 343 570-001	L-SX0311-002	1GA 007 506-012
0608210	2BA 009 001-201	600177	8GP 002 095-121	228 155	1G0 996 176-111	L-SX0311-005	2ZR 005 860-151
0608220	9HB 161 122-012	600178	8GP 002 095-241	230 3967	2JA 001 364-001	L-SX0311-010	2NE 959 821-201
0608230	1BL 010 820-801	600198	8JA 001 909-001	618 979	8GM 002 092-121	L-SX0311-012	1GA 006 991-051
0608240	1K0 247 043-117	600206	8JA 003 526-001	620 269	2JA 001 330-031	L-SX0311-014	2ZR 996 188-091
0608250	2PT 009 599-131	600207	8JA 003 526-001	631 632	2JA 003 232-011	L-SX0311-555	1GA 005 060-001
0608260	2PT 009 599-141	600219	8JB 001 943-001	751 759	2PF 961 167-021	L-SX0311-666	1ND 005 700-061
0608270	8KA 165 959-001	600222	8JB 001 943-001	853 45	9BG 993 345-001	L-SX0311-777	2NE 003 236-001
0608280	9AH 165 968-001	600228	8JB 004 777-001	ACFE02109060	1G0 996 176-131	L-SX0311-777	2NE 003 236-008
0608290	1AL 010 820-841	600228	8JB 004 777-002	ACFE02109060	1G0 996 176-137	L-SX0311-888	1NE 006 300-051
0608300	9XS 254 229-007	600312	8KW 701 235-033	EC1993138	1GL 008 090-217	L-SX0311-999	1GD 003 590-701
0801070	8GA 002 071-121	600340	8RA 003 326-031	EC1993138	1GL 008 090-217	L-SX0352-001	2TM 003 748-011
0801070	8GA 002 071-123	600342	8RA 004 412-001	EC2526642	1EB 996 167-177	L-SX0352-001	2X5 008 078-001
0801960	9GT 963 129-001	600343	9EL 132 215-001	EC2888632	4DM 009 492-001	L-SX0352-001	2X5 008 078-007
100150	2PS 964 295-001	600346	9EL 115 830-001	EC4244286	2PF 009 001-177	L-SX0435-888	2SD 001 685-218
100150	2PS 964 295-007	600347	9EL 132 215-011	EC6C9121	2BA 009 001-167	L-SX0435-888	2SD 001 685-218
100151	2PS 964 295-051	600349	9GB 121 587-031	HA4 220512	2JA 001 357-002	L-SX0436-888	2SE 001 685-201
100153	2PS 964 295-057	600349	9GB 121 587-037	HA4 240149	1GA 005 060-001	L-SX0461-001	8HG 002 365-001
101202	2BM 006 355-017	600515	8KA 152 134-007	HA4 240149	1GB 006 213-101	L-SX0461-002	8HG 006 294-021
190564	2ZR 002 985-261	601208	8KA 146 751-007	Fruehauf	1GB 006 213-107	L-SX0462-001	8GH 002 089-251
300018	9HD 149 253-007	601221	2PT 006 362-801	HELLA		L-SX0462-001	8GH 002 089-253
300018	2XT 008 929-001	805287	8GJ 002 525-281	L-SA0023-001	2PG 003 748-151	L-SX0465-001	2SA 006 717-001
300018	2XT 008 929-007	850551	8JD 008 151-051	L-SA0024-001	2TM 003 748-011	L-SX0465-001	2SA 006 717-001
600002	1K0 008 192-001	850552	8JD 008 151-011	L-SA0078-005	8KA 340 859-001	L-SX0472-001	2XW 002 897-051
600002	1K0 008 192-007			L-SA0078-006	8KA 340 859-011	L-SX0495-001	2PS 962 964-012
600008	1BL 008 193-001			L-SA0078-007	8KA 340 859-011	L-SX0495-001	2PS 962 964-018
600008	1BL 008 193-007			L-SA0080-001	8KA 340 864-011	L-SX0498-001	2PS 006 717-031
600008	2BM 008 355-001			L-SA0080-006	2VP 340 930-111	L-SX0498-888	2PF 006 717-011
600008	2BM 008 355-007			L-SA0080-007	2VP 340 950-011	L-SX0503-001	2PS 006 717-061
600008.1	8KA 157 425-007			L-SA0080-009	2VP 340 961-011	L-SX0503-001	2PS 006 717-067
600008.1	9GH 158 051-007			L-SA0080-999	8XS 340 092-011	L-SX0526-001	9GT 963 129-001
600009.1	8GA 006 841-121			L-SA0081-006	2VP 340 950-021	L-SX0541-001	2PS 003 748-121
600009.1	8GA 006 841-123			L-SA0081-007	2VP 340 961-021	L-SX0541-001	2PS 003 748-127
600014	1NO 008 582-001			L-SA0081-009	2VP 340 960-121	L-SX0561-001	2PG 962 964-051
600014	1NO 008 582-007			L-SA0082-001	2KA 340 828-001	L-SX0561-002	2SA 962 964-001
600027	1BL 139 277-031			L-SA0082-002	2KA 959 640-661	L-SX0562-001	9GD 963 281-001
600028	1BL 139 278-031			L-SA0083-001	2PS 008 645-301	SK-0108-901	9EL 122 772-051
600030	2JA 001 364-001			L-SA0083-002	2PS 008 645-361	TZ-018257-L50P02	8JA 001 925-001
600031	1NL 007 186-047			L-SA0084-001	8HG 340 489-001		
600035	2KA 001 386-231			L-SA0085-001	2PG 008 645-321		
600038	2XA 008 221-021			L-SA0085-002	2PG 008 645-967		
600038	2XA 008 221-027			L-SA0086-002	2X5 340 827-001		
600038.1	2DA 008 136-017			L-SA0086-003	2X5 340 827-011		
600041	2KA 001 322-001			L-SA0086-004	2X5 302 240-051		
600042	2KA 003 168-021			L-SA0086-005	2X5 340 447-001		
600043	2PF 003 563-151			L-SA0086-006	2X5 340 447-021		
600044	2AA 003 257-041			L-SA0086-008	2X5 302 241-071		
600044	2AA 003 257-042			L-SA0086-009	2X5 011 769-021		
600046	2KA 003 389-001			L-SA0086-010	2X5 011 769-011		
600046	2KA 003 389-061			L-SA0087-002	8KA 340 819-001		
600046	2KA 003 389-062			L-SA0088-001	8KA 340 818-001		
600046	2KA 003 389-068			L-SA0088-002	8KA 340 841-001		
600047	2NE 003 030-151			L-SA0088-012	8KA 340 842-011		
600055	2PS 962 964-031			L-SA0088-013	8KA 340 843-001		
600055	2PS 962 964-037			L-SA0089-004	8KA 340 815-011		
600056	2SA 008 405-021			L-SA0089-005	2ZR 997 506-391		
600056	2SA 008 405-027			L-SA0091-002	2ZR 005 860-151		
600056.1	8RA 008 405-001			L-SA0091-003	9HV 340 812-007		
600056.1	8RA 008 405-007			L-SA0091-004	9XX 340 870-007		
600056.2	8XU 008 405-031			L-SA0092-001	9XX 340 882-001		
600056.2	8XU 008 405-037			L-SA0092-002	9XX 340 879-001		
600057	9GT 963 129-001			L-SA0094-003	9XX 340 884-001		
600058	2PF 003 057-041			L-SA0094-004	9XX 340 881-001		
600059	2SD 001 680-271			L-SA0111-001	5DS 009 552-001		
600060	2SD 001 680-281			L-SA0114-001	2JA 010 838-017		
600061	2PF 961 167-021			L-SA0126-001	9DW 178 909-011		
600068	2NE 008 221-031			L-SA0126-002	9DW 178 909-021		
600068	2NE 008 221-037			L-SK0018-002	8GP 002 066-241		
600069	2ZR 008 221-051			L-SK0019-002	8GA 002 083-251		
600069	2ZR 008 221-057			L-SK0021-004	8GP 002 067-241		
600070	9GT 137 236-007			L-SK0030-002	8GH 002 090-251		
600072	2SK 004 460-031			L-SK038	8GH 002 090-253		
600072	2SK 004 460-037			L-SK038	2JA 003 232-001		
600073	2KA 001 378-001			L-SK0038-001	2JA 003 232-011		
600073	2KA 005 049-011			L-SK0038-002	2JA 001 357-012		
600073	2KA 005 049-017			L-SK0095-002	2ZR 003 236-051		
600074	2X5 008 479-001			L-SK0095-002	2ZR 003 236-057		
600074	2X5 008 479-007			L-SK0101	2X5 005 020-011		
600074	2X5 008 479-081			L-SK0108-005	2SK 003 567-311		
600074	2X5 008 479-087			L-SK0108-006	2SK 003 567-321		
600074.1	2X5 008 479-091			L-SK0129	2X5 950 071-031		
600075	2SK 004 460-041			L-SK0150-001	2X5 005 020-017		
600077	2TM 003 057-031			L-SK0150-002	2X5 005 020-017		
600078	2X5 005 020-001			L-SK0150-005	2X5 005 020-111		
600078	2X5 005 020-002			L-SW0010-002	2XA 959 560-411		
600078	2X5 005 020-003			L-SW0010-002	2XA 959 560-417		
600079	2X5 005 020-081			L-SX0030-002	8GA 002 071-241		
600080	2X5 950 071-031			L-SX0031-001	2KA 003 389-061		
600085	2ZR 003 315-041			L-SX0031-001	2KA 003 389-062		

Manufacturer's no. / HELLA no.

Cross-Reference



Hako	HELLA	Hanomag-Henschel	HELLA	Hanomag-Henschel	HELLA	Hercules	HELLA
90-04313-4	8HG 002 365-001	20K4631820	8RA 004 412-021	42Y0 6H3 050	8RA 004 412-001	927 340 18 02	2BA 001 236-001
90-04638-4	2RL 008 060-101	289 5819 M91	1G5 003 241-021	42Y0 6H3 190	2VP 006 040-111	P00927 340 1802000	2BA 001 236-001
90-04942-0	6EG 001 567-041	289 7205 M91	2AB 001 208-001	42Y0 6H3 190	2VP 006 040-117	P00927 360 1104	8JA 001 909-001
90-06799-2	8JA 001 909-011	290 4951 M91	2JA 001 360-001	42Y0 6H3 200	2VP 006 040-121		
90-09329-5	2BA 003 014-111	2904 951 M91	2JA 001 360-001	42Y0 6H3 200	2VP 006 040-127		
90108358	2KA 001 378-001	292 4326 M91	2AA 001 200-011	42Y0 6H3 220	2VP 006 040-127		
90-11697-1	2SW 003 014-131	292 4326 M91	2AA 001 200-012	42Y0 6H3 220	2VP 006 040-127		
90-12655-8	4RA 965 400-001	292 4326 M91	2AA 001 200-012	42Y06-HOP01	2VP 006 040-127		
90-13831-4	2PF 001 648-161	292 4326 M91	2AA 001 200-012	42Y06-HOP02	2VP 006 040-127		
90-14181-3	8JB 004 777-001	292 4332 M91	2AA 001 200-021	4600 186 M1	2VP 006 040-127		
90-14181-3	8JB 004 777-002	292 4332 M91	2AA 001 200-021	4603 153 M1	2VP 006 040-127		
90-15188-7	1TA 003 570-101	292 4332 M91	2AA 001 200-023	4603 153 M1	2VP 006 040-127		
90154444	2SY 003 014-121	292 4342 M91	2ZR 001 240-351	4603 561 M1	2VP 006 040-127		
90-17773-4	2BA 001 277-011	292 8260 M1	123 001 117-041	4603 645 M91	2VP 006 040-127		
90-17774-2	2BA 001 277-021	292 8454 M1	9FF 090 500-001	4901 612 M1	2VP 006 040-127		
90178062	2KA 003 184-021	293 3949 M1	9RD 104 336-001	4901 618 M1	2VP 006 040-127		
90-17808-6	2SD 003 168-041	293 3953 M1	9FR 093 887-001	4917 451 M91	2VP 006 040-127		
90-17808-6	2SD 003 184-041	293 3967 M91	9FD 104 336-001	4917 453 M91	2VP 006 040-127		
90-17808-8	2SD 003 184-031	293 7744 M91	2JA 001 364-001	4917 455 M91	2VP 006 040-127		
90-17808-8	2SD 003 184-037	2933 967 M91	2JA 001 364-001	4918 463 M91	2VP 006 040-127		
90-17809-6	2SD 003 184-041	2933 968 M91	2JA 001 364-001	4918 464 M1	2VP 006 040-127		
90-17809-6	2SD 003 184-047	2933 969 M91	2JA 001 364-001	4919 157 M91	2VP 006 040-127		
90191594	2SD 003 182-051	294 2064 M1	9ES 012 060-011	50102640	2VP 006 040-127		
90191594	2SD 003 182-051	294 2095 M1	9GD 023 639-001	50134398	2VP 006 040-127		
90-19160-2	2SE 003 182-021	294 2097 M1	9DR 090 206-001	503 6014	2VP 006 040-127		
90-19161-0	2SD 003 182-061	294 2098 M1	9KS 075 139-001	504 8844	2VP 006 040-127		
90-19161-0	2SD 003 182-067	294 9835 M91	9JA 001 909-011	516 2459 8	2VP 006 040-127		
90-19162-8	2SE 003 182-011	2942 098 M1	9KS 075 139-001	751 8700 07	2VP 006 040-127		
90-19162-8	2SE 003 182-017	2949 833 M91	2BA 002 324-021	76629173	2VP 006 040-127		
90-19447-3	1G4 003 470-031	2949 835 M91	8JA 001 909-011	76629173	2VP 006 040-127		
90-19456-4	8GH 002 090-251	295 1380 M91	2PF 001 634-101	769 6167 3	2VP 006 040-127		
90-19456-4	8GH 002 090-253	2951 380 M91	2PF 001 634-101	76961873	2VP 006 040-127		
90197500	2TJ 001 633-211	2954 497 M91	2BA 002 324-001	76961873	2VP 006 040-127		
90-22568-1	1AA 004 109-031	296 1720 M1	9GD 024 183-001	77004473	2VP 006 040-127		
90-22708-3	2BE 003 014-251	296 1721 M1	9KS 075 307-001	79334373	2VP 006 040-127		
90-22708-3	8RA 004 412-021	296 2889 M1	9DR 060 577-001	794 3817 3	2VP 006 040-127		
90-23160-6	2SE 002 578-701	2981 532 M91	1A7 003 099-011	89649740	2VP 006 040-127		
90-24388-2	2SE 002 578-701	299 8822 M1	9ES 015 675-001	89674540	2VP 006 040-127		
90-24388-2	2SE 002 578-707	2999 797 M1	2XW 003 146-001	89674540	2VP 006 040-127		
90-24826-1	2BA 002 652-111	20G0 6K1 120	2BA 003 014-111	9750 010 65	2VP 006 040-127		
90-24826-1	2BA 002 652-101	20G0 6K1 130	2BA 002 652-101	9 969 071 237 101	2VP 006 040-127		
90-24827-9	2BA 002 652-101	306 2196 M8	2BA 002 652-101	9 969 071 237 102	2VP 006 040-127		
90-24827-9	2BA 002 652-121	306 2228 M8	2BA 002 652-101	9 969 071 237 103	2VP 006 040-127		
90-24827-9	2BA 002 652-121	306 2229 M8	2BA 002 652-101	9 969 071 282 002	2VP 006 040-127		
90-29104-8	2XS 950 071-031	306 5113 M8	2BA 002 652-101	9 969 071 282 008	2VP 006 040-127		
90-32191-0	2XS 005 020-011	307 5726 M91	2BA 002 652-101	9 969 071 282 009	2VP 006 040-127		
90-32191-0	2XS 005 020-017	308 3483 M91	2BA 002 652-101	9 969 071 282 011	2VP 006 040-127		
90321928	1GA 005 060-001	308 6298 M91	2BA 002 652-101	9 969 071 282 011	2VP 006 040-127		
90-33707-2	8JA 001 909-001	308 6298 M91	2BA 002 652-101	9 969 071 282 011	2VP 006 040-127		
90-34013-1	8GJ 002 525-131	308 6298 M91	2BA 002 652-101	9 969 071 282 011	2VP 006 040-127		
90-34013-1	8GJ 002 525-136	308 6298 M91	2BA 002 652-101	9 969 071 282 011	2VP 006 040-127		
90-34014-6	2SD 002 582-011	3081 528 M1	2BA 002 652-101	9 969 071 282 011	2VP 006 040-127		
90-34014-6	2SD 002 582-017	3082 018 M1	2BA 002 652-101	9 969 071 282 011	2VP 006 040-127		
90-34014-7	2SD 002 582-021	309 3000 M91	2BA 002 652-101	9 969 071 282 011	2VP 006 040-127		
90-34014-7	2SD 002 582-027	3093 002 M1	2BA 002 652-101	9 969 071 282 011	2VP 006 040-127		
90-34015-0	1AB 006 213-011	310 1699 M1	2BA 002 652-101	9 969 071 282 011	2VP 006 040-127		
90-34015-0	2KA 004 525-001	3228 01M 1	2BA 002 652-101	9 969 071 282 011	2VP 006 040-127		
90-34015-4	2JA 001 330-001	32309340	2BA 002 652-101	9 969 071 282 011	2VP 006 040-127		
90-34015-4	2JA 001 330-007	32483940	2BA 002 652-101	9 969 071 282 011	2VP 006 040-127		
90-34017-1	8JA 001 909-001	32484040	2BA 002 652-101	9 969 071 282 011	2VP 006 040-127		
90-34058-1	8HG 006 294-031	32484040	2BA 002 652-101	9 969 071 282 011	2VP 006 040-127		
90-34396-3	2RL 006 846-001	395 9358 13	2BA 002 652-101	9 969 071 282 011	2VP 006 040-127		
90-34397-1	8HG 006 294-051	4003 757 M91	2BA 002 652-101	9 969 071 282 011	2VP 006 040-127		
90-34526-5	2BA 002 324-001	4003 757 M91	2BA 002 652-101	9 969 071 282 011	2VP 006 040-127		
90-34526-5	2BA 002 324-001	4061 82M 1	2BA 002 652-101	9 969 071 282 011	2VP 006 040-127		
90-34530-7	9FF 126 444-001	4062 18M 1	2BA 002 652-101	9 969 071 282 011	2VP 006 040-127		
90-34602-8	2KA 006 896-001	4062 18M 1	2BA 002 652-101	9 969 071 282 011	2VP 006 040-127		
90-34602-8	2KA 006 896-007	416Z 811 240	2BA 002 652-101	9 969 071 282 011	2VP 006 040-127		
90-35055-9	2ZR 003 315-041	4180 6K1 910	2BA 002 652-101	9 969 071 282 011	2VP 006 040-127		
90-37970-2	8HG 003 799-001	4180 6K1 990	2BA 002 652-101	9 969 071 282 011	2VP 006 040-127		
90-37973-6	2RL 006 846-011	4180 6K2 250	2BA 002 652-101	9 969 071 282 011	2VP 006 040-127		
90-39206-9	2NE 003 315-011	4189 57H 110	2BA 002 652-101	9 969 071 282 011	2VP 006 040-127		
90-39243-2	2KA 001 389-101	41L0 6H3 020	2BA 002 652-101	9 969 071 282 011	2VP 006 040-127		
90-39604-5	2ZR 006 609-081	41L0 6H3 020	2BA 002 652-101	9 969 071 282 011	2VP 006 040-127		
90-39604-5	2ZR 006 609-087	4201 273 M1	2BA 002 652-101	9 969 071 282 011	2VP 006 040-127		
90-41501-9	2BA 008 221-001	4210 6H3 080	2BA 002 652-101	9 969 071 282 011	2VP 006 040-127		
90-41501-9	2BA 008 221-007	4210 6H7 100	2BA 002 652-101	9 969 071 282 011	2VP 006 040-127		
90417932	2PT 008 362-801	4210 6H7 100	2BA 002 652-101	9 969 071 282 011	2VP 006 040-127		
90-43445-7	1GL 008 090-211	42106H2780	2BA 002 652-101	9 969 071 282 011	2VP 006 040-127		
90-43445-7	1GL 008 090-211	42106H3160	2BA 002 652-101	9 969 071 282 011	2VP 006 040-127		
90445602	8RA 004 412-001	4215 6H2 430	2BA 002 652-101	9 969 071 282 011	2VP 006 040-127		
90-71340-5	2SE 002 578-701	4219 57H 140	2BA 002 652-101	9 969 071 282 011	2VP 006 040-127		
90-71340-5	2SE 002 578-707	4220 512 M91	2BA 002 652-101	9 969 071 282 011	2VP 006 040-127		
90-73843-6	8HG 006 294-031	4220 546 M91	2BA 002 652-101	9 969 071 282 011	2VP 006 040-127		
90-74099-4	1GB 006 213-101	423 06H2 630	2BA 002 652-101	9 969 071 282 011	2VP 006 040-127		
90-74237-0	1GB 006 213-107	4230 6H2 140	2BA 002 652-101	9 969 071 282 011	2VP 006 040-127		
90-74566-2	9BG 993 345-001	4240 147 M91	2BA 002 652-101	9 969 071 282 011	2VP 006 040-127		
90-75158-7	2BE 001 259-061	4240 149 M91	2BA 002 652-101	9 969 071 282 011	2VP 006 040-127		
90752957	2KA 003 168-021	4241 028 M91	2BA 002 652-101	9 969 071 282 011	2VP 006 040-127		
90752957	2SE 003 184-017	4241 079 M91	2BA 002 652-101	9 969 071 282 011	2VP 006 040-127		
90-79421-5	2RL 007 551-011	4241 079 M91	2BA 002 652-101	9 969 071 282 011	2VP 006 040-127		
90-79422-3	8HG 006 294-041	4241 080 M91	2BA 002 652-101	9 969 071 282 011	2VP 006 040-127		
90-79921-4	2RL 006 846-011	4241 080 M91	2BA 002 652-101	9 969 071 282 011	2VP 006 040-127		



Manufacturer's no. / HELLA no. Cross-Reference

Herth + Buss	HELLA	Herth + Buss	HELLA	Herth + Buss	HELLA	Hobby	HELLA
82 840 318	2SD 001 685-211	89 901 107	8GA 002 072-121	D012.0003.200	2XS 005 639-001	6501430097	2KA 003 389-062
82 840 363	2VP 008 204-041	89 901 108	8GA 002 071-261	D012.0007.000	2XS 005 020-001	6501430097	2KA 003 389-068
82 840 368	2VD 008 204-051	89 901 109	8GA 002 071-271	D012.0007.010	2XS 005 020-011	6501450007	2DA 343 800-001
82 840 513	2VD 008 204-131	89 901 110	8GH 008 358-121	D012.0007.020	2XS 005 020-021	6501450007	2DA 343 800-007
82 840 520	2VD 008 204-131	89 901 113	8GD 002 084-131	D013.0006.000	2SA 006 717-001	6501460099	2DA 008 136-002
82 840 524	2VP 008 204-181	89 901 114	8GD 002 084-251	D013.1006.000	2BA 001 259-611	6501460099	2DA 008 136-027
82 840 525	2VD 008 204-191	89 901 115	8GA 002 083-131	D013.4001.101	2KA 001 389-101	6501460203	8KA 146 751-011
82 840 526	2VP 008 204-181	89 901 116	8GA 002 083-251	D013.4001.101	2KA 003 168-021	6501540005	2NE 343 130-277
82 840 544	2VP 008 204-221	89 901 120	8GP 002 066-121	D013.5015.000	2PF 006 717-011	6501560005	2BA 343 130-297
82 840 546	2VD 008 204-231	89 901 121	8GP 002 066-241	D016.0005.002	2RL 006 846-001	6501610093	8RA 002 020-001
82 840 547	2VD 008 204-251	89 901 128	8GH 005 635-121	D016.0005.012	2RL 006 846-011	6501610093	8RA 002 020-002
82 840 548	2VP 008 204-241	89 901 129	8GH 005 636-121	D019.0003.200	9EL 119 397-001	6501620005	8RA 002 016-111
82 840 578	2VD 007 500-111	89 901 130	8GP 002 068-121	D019.0007.000	9EL 129 519-001	6501620093	8RA 002 020-031
82 840 579	2VD 007 500-201	89 901 131	8GP 002 068-241	D019.2107.002	9EL 859 020-001	6501640012	8RA 009 001-031
82 840 588	2VD 007 500-411	89 901 132	8GP 002 067-121	D032.0004.000	8RA 002 020-001	6501640012	8RA 009 001-037
82 840 589	2VP 007 500-421	89 901 133	8GP 002 067-241	10 88 00 29	2BA 005 603-001	6501660093	8RA 003 326-011
82 840 603	2VD 008 204-131	89 901 134	8GP 002 067-261	Hobby	HELLA	6501660093	8RA 003 326-017
82 840 606	2VD 008 204-111	89 901 140	8GA 002 071-121	02312567	8HG 006 294-021	6501670011	2NE 344 610-007
82 840 606	2VD 008 204-131	89 901 141	8GA 002 071-131	260015	8RA 003 326-011	6501670093	8RA 003 326-011
82 840 607	2VD 008 204-111	89 901 142	8GA 002 071-241	260015	8RA 003 326-017	6501720012	2NE 009 001-021
82 840 607	2VP 008 204-121	89 901 143	8GA 002 071-251	260027	2SD 004 460-011	6501720012	2NE 009 001-027
82 840 608	2VP 008 204-101	89 901 144	8GA 002 074-121	260027	2SD 004 460-017	6501780012	2NE 009 001-021
82 840 609	2VP 008 204-121	89 901 145	8GA 002 074-241	260047	2SD 004 460-001	6501780012	2NE 009 001-027
82 840 610	2VP 008 204-101	89 901 147	8GA 002 073-251	260055	8GH 002 473-151	6501940004	2XT 007 945-027
82 840 617	2VP 008 204-041	89 901 148	8GA 002 072-241	260105	2KA 001 378-127	6501960004	2JA 998 560-017
82 840 618	2VD 008 204-051	89 901 150	8GM 002 092-121	260145	2PF 003 057-001	6502010093	8GM 002 092-121
82 840 620	2VP 008 204-081	89 901 151	8GM 002 091-131	260147	2PF 004 081-001	6502020000	8GM 002 091-131
82 840 622	2VD 008 204-091	89 901 152	8GM 002 092-241	260147	2PF 004 081-007	6502050093	8GP 002 067-121
82 840 622	2VP 008 204-081	89 901 155	8GM 002 091-121	260217	9EL 132 215-001	6502050093	8GP 002 067-123
82 840 622	2VP 008 204-101	89 901 156	8GM 002 091-241	260287	8GP 002 067-121	6502060093	8GA 002 071-121
82 840 656	2VD 008 205-051	89 901 157	8GM 002 094-121	260287	8GP 002 067-123	6502060093	8GA 002 071-123
82 840 657	2VP 008 205-031	89 901 158	8GM 002 091-251	260317	8GA 002 073-121	6502060093	8GA 002 071-121
82 840 700	2SK 340 101-001	89 901 162	8GM 002 091-181	260317	8GA 002 073-123	6502070093	8GA 002 071-123
82 840 706	2SK 340 101-001	89 901 164	8GH 008 417-012	260318	2AA 003 257-001	6502070093	8GA 002 071-133
82 840 706	9EL 340 201-001	89 901 168	8GH 008 356-121	260387	8RA 003 326-011	6502080093	8GA 002 071-133
82 840 800	2VP 008 789-071	89 901 169	8GA 008 901-241	260387	8RA 003 326-017	6502080093	8GA 002 073-121
82 840 804	2VP 008 789-021	89 901 170	8GP 002 095-121	6100570005	2JA 998 569-017	6502090093	8GA 002 073-123
82 841 209	9EL 137 307-001	89 901 171	8GP 002 095-241	6500410095	2PF 964 295-017	6502090093	8GD 002 078-121
82 841 210	9EL 137 308-001	89 901 173	8GP 003 594-141	6501010003	2PF 964 295-027	6502100095	8GA 006 841-121
82 842 193	9EL 340 201-001	89 901 174	8GP 003 594-241	6501010093	2PF 964 295-027	6502100095	8GA 006 841-123
82 842 578	9EL 131 420-001	89 901 175	8GP 003 594-121	6501020007	2PF 964 295-257	6502110095	8GP 003 594-141
82 842 578	9EL 134 296-041	89 901 176	8GA 007 997-011	6501030087	2PF 004 081-107	9107810107	1N0 009 295-031
82 842 579	9EL 131 420-011	89 901 177	8GP 003 594-251	6501030087	2PF 964 295-257	9107810107	1N0 009 295-037
82 842 579	9EL 134 296-051	89 901 178	8GP 003 594-541	6501050003	2PF 004 081-001	9107810207	1N0 009 295-041
82 842 608	9EL 152 891-001	89 901 181	8GD 002 078-241	6501050003	2PF 004 081-007	9107810207	1N0 009 295-047
82 842 620	9EL 152 889-001	89 901 182	8GA 007 997-021	6501050003	2SB 964 169-531	9107810307	5DF 009 244-007
82 850 300	2SA 003 236-041	89 901 185	8GA 008 899-061	6501060093	2SB 964 169-537	M260055	8GH 002 473-151
82 852 300	9EL 120 201-001	89 901 190	8GA 006 841-121	6501060093	2PF 961 167-021	M260298	8GP 002 066-121
82710238	2XS 955 031-001	89 901 191	8GA 006 841-241	6501060093	2PG 964 295-011	M260318	2AA 003 257-001
82710327	2PG 008 645-631	89 901 195	8GD 004 772-121	6501070001	2PG 964 295-017	Holder	HELLA
83 830 186	2VD 003 567-371	89 901 196	8GA 008 892-002	6501070001	2PG 964 295-011	000 180 12 22	2SB 001 259-261
83 830 188	2SL 003 567-311	89 901 197	8GD 008 893-002	6501070001	2PG 964 295-017	0001801021	2SB 001 301-021
83 830 207	2SE 002 578-701	89 901 202	8GH 007 157-121	6501070001	2PG 964 295-017	0001801220	2ST 001 259-321
83 830 216	2SE 003 167-031	89 901 204	8GH 002 089-501	6501090007	2XS 008 479-117	0001801221	2SB 001 259-261
83 840 186	2VP 003 567-121	89 901 207	8GH 007 157-241	6501090007	2XS 008 479-107	0001807865	2BE 001 259-061
83 840 188	2SK 003 567-321	89 901 211	8GH 002 090-371	6501100007	2XS 008 479-081	0001810009	2AA 001 200-011
83 840 216	2SE 003 167-031	89 901 213	8GH 002 089-141	6501100007	2XS 008 479-087	0001810009	2AA 001 200-012
83 840 318	2SD 001 685-211	89 901 216	8GH 002 090-371	6501100107	2XS 008 479-091	0001821351	8JA 001 909-011
83 840 584	2VP 008 204-241	89 901 217	8GH 007 157-181	6501100107	2XS 008 479-097	012033	8GD 002 084-131
83 840 585	2VD 008 204-251	89 901 218	8GJ 002 525-361	6501110093	2XS 005 020-057	019596	2BA 001 227-201
83830111	2SD 003 182-051	89 901 220	8GS 007 949-261	6501110093	2XS 005 020-137	021163	2KA 001 389-101
83830307	2VD 008 205-011	89 901 221	8GS 007 949-261	6501120003	2XS 964 295-031	021164	2KA 003 168-021
83832186	2VD 008 205-021	89 901 232	8GS 006 677-121	6501120003	2XS 964 295-037	022369	9EL 854 912-001
83832186	9EL 122 689-021	89 901 234	8GS 007 997-201	6501120003	2XS 964 295-037	023683	1GA 007 506-001
83840182	2SD 344 100-001	89 901 239	8GA 007 997-191	6501120007	2XS 964 295-037	023683	1GA 007 506-002
83840212	2SD 001 689-061	89 901 240	8GA 007 997-041	6501120007	2XS 964 295-037	024269	1GA 007 506-007
83840588	2VD 007 500-411	89 901 241	8GA 007 997-061	6501120013	2XS 964 295-037	024269	9XR 854 840-001
83840589	2VP 007 500-421	89 901 244	8GA 007 997-081	6501120013	2TM 964 295-101	024290	8JA 001 909-001
83840621	2VP 008 204-081	89 901 245	8GA 007 997-071	6501130005	2TM 964 295-107	025813	1AB 004 231-001
83840622	2VD 008 204-091	89 901 245	8GH 007 643-121	6501210093	2PS 002 727-001	025816	8GJ 002 525-136
83840623	2VD 008 204-091	89 901 246	8GA 007 997-111	6501220095	2PS 962 964-031	025816	8GJ 002 525-136
83840624	2VP 008 204-081	89 901 253	8GA 007 997-272	6501220096	2PS 962 964-037	027178	9GH 116 966-011
83840700	2SK 340 101-001	89 901 263	8GA 007 997-101	6501220096	2PS 962 964-037	027887	2SE 004 623-001
83840808	2VP 340 450-031	89 901 267	8GH 008 356-181	6501220099	2PS 964 295-001	027887	2RL 006 846-001
83840809	2VP 340 450-021	89 901 269	8GH 008 358-181	6501220099	2PS 964 295-007	027889	2VP 006 040-127
83842193	9EL 340 201-001	89 901 270	8GH 007 997-211	6501220099	9GD 343 697-007	027889	2VP 006 040-127
83842578	9EL 134 296-041	89 901 271	8GA 007 997-091	6501220195	9GT 963 129-001	027890	2BV 006 040-051
83842579	9EL 134 296-051	89 901 272	8GA 007 997-171	6501220196	9GD 963 281-001	027952	9EL 859 020-001
83842608	9EL 152 891-001	89 901 273	8GA 007 997-141	6501220295	8GP 003 594-121	028143	9EL 129 519-001
84 740 034	2JA 003 232-011	89 901 275	8GA 007 997-161	6501220299	8GP 003 594-121	028399	9EL 136 825-011
84 740 038	2JA 001 335-011	89 901 276	8GA 007 997-151	6501230004	2PS 964 295-061	028400	9EL 136 833-011
84 740 502	2JA 007 372-001	89 901 277	8GA 007 997-221	65012400??	2PS 964 295-067	029990	2VP 006 040-111

Manufacturer's no. / HELLA no.

Cross-Reference



Holder	HELLA	Hymer France	HELLA	Hymer France	HELLA	Hymer France	HELLA
792056	9GH 096 532-001	0417296-00	2BN 964 169-051	0877679-00	2BN 964 169-051	1365277	1N0 009 295-031
792977	9K5 075 307-001	0417296-00	2BN 964 169-057	0877679-00	2BN 964 169-057	1365277	1N0 009 295-037
797012	2BA 997 027-031	0417296-00	2BN 964 169-247	0877688-00	1BL 006 349-011	1365277-00	1N0 009 295-031
797144	9EL 136 825-001	0417297-00	2PF 008 221-011	0877689-00	1K2 006 147-031	1365277-01	1N0 009 295-037
797296	1AA 004 109-021	0417297-00	2PF 008 221-017	0878761	2JA 002 661-001	1380208	2ZR 965 039-041
798237	2SD 343 130-011	0417298-00	6NM 007 282-221	0879948	2BA 008 221-001	1380208	2ZR 965 039-047
798237	2SD 343 130-017	0417299-00	8HG 153 152-001	0879948	2BA 008 221-007	1380208	2ZR 965 039-327
Honda	HELLA	0417305-00	9GH 152 654-007	0879948-00	2BA 008 221-001	1380208-00	2ZR 965 039-041
33 110 SA0 742	1AE 003 427-011	0417307-00	2DA 959 071-537	0879948-00	2BA 008 221-007	1380208-00	2ZR 965 039-047
Hymer France	HELLA	0417308-00	2BM 008 355-001	0879948-00	2BA 008 221-107	1380208-00	2ZR 965 039-327
003899	8GP 002 067-241	0417308-00	2BM 008 355-007	0879949-00	8KA 152 134-007	1380209	2NE 965 039-327
01201689	2XS 008 479-001	0417336-00	8GA 002 071-121	0879950	1K0 008 191-001	1380209-00	2NE 965 039-327
01201689	2XS 008 479-007	0417336-00	8GA 002 071-123	0879950	1K0 008 191-007	1380211	2PF 003 563-177
0380081	2XW 003 146-001	0417336-00	8GA 002 071-121	0879950-00	1K0 008 191-001	1380211-00	5DV 008 855-007
0380081	2XW 007 146-001	0417337-00	8GM 002 092-121	0879951-00	1K0 008 191-007	1401200	5DV 008 855-007
0410153	2XS 005 639-002	0417338-00	8GD 002 078-121	0879951-00	1BL 008 193-001	1401200	8GH 007 157-901
0410153	2XS 005 639-002	0417338-00	8GD 002 078-121	0879952-00	1BL 008 193-007	1403039	8GH 007 157-901
0410188	2VP 006 040-111	0417339-00	8GH 002 090-133	0880057	9GH 152 654-007	1403039-00	2PG 006 717-021
0410188	2VP 006 040-117	0417339-00	8GH 002 090-136	0880057	2XS 964 295-037	1435715-00	2PG 006 717-027
0410188-00	2VP 006 040-111	0417343-00	8GA 002 073-121	0880057-00	2XS 964 295-031	1435749	2VP 998 232-261
0410188-00	2VP 006 040-117	0417343-00	8GA 002 073-123	0880057-00	2XS 964 295-037	1435749-00	2VB 998 232-221
0411229	8KA 146 751-007	0417343-00	8GA 002 073-121	0881273	2DA 008 136-017	1435750-00	2VA 998 232-291
041122900	8KA 146 751-007	0417343-00	8GA 002 073-123	0881273-00	2DA 008 136-017	1441654-00	8WT 008 549-101
0411473-00	9GT 137 236-007	0417346-00	2BA 007 502-061	0882283-00	9GH 145 943-001	1442935	8RA 343 160-002
0416015	4RA 003 530-001	0417346-00	2VA 007 502-061	0882556	6NM 007 282-221	1442935	8RA 343 160-007
0416201-00	2AA 003 557-021	0417349	9EL 964 531-001	0882556-00	6NM 007 282-221	1442935-00	8RA 343 160-002
0417046	2KA 006 896-001	0417352	2TA 964 169-061	0882916-00	2PG 964 295-011	1442935-00	8RA 343 160-007
0417046	2KA 006 896-007	0417352	2TA 964 169-067	0882916-00	2PG 964 295-017	1444723-00	8RA 343 160-007
0417047-00	2PS 962 964-031	0417352	9EL 964 532-001	0883120-00	1BL 007 834-037	1476689	9GS 146 999-727
0417047-00	2PS 962 964-037	0417356-00	8GA 006 841-121	0883485-00	8WS 008 549-001	1476689 5M	9GS 146 999-727
0417048-00	1NL 007 186-021	0417356-00	8GA 006 841-123	0884392-00	2PS 007 943-011	1521746	2DA 343 800-001
0417048-00	1NL 007 186-027	0417370	8GA 002 020-001	0884392-00	2PS 007 943-017	1521746	2DA 343 800-007
0417059	2KA 004 331-061	0417382	8RA 002 020-002	0887680	2KA 004 331-061	1521746-00	2DA 343 800-001
0417059	2KA 004 331-067	0417382	8GH 007 157-121	0888345	2KA 004 331-067	1521746-00	2DA 343 800-007
0417067	1BL 006 349-011	0417510	8GH 007 157-126	0888345	2ZR 008 221-137	1529747	9BG 154 271-001
0417067-00	1BL 006 349-011	0417510	2KA 003 389-061	0888346	2NE 008 221-137	158 4277	2BA 009 001-191
0417068	1K2 006 147-031	0417510	2KA 003 389-062	0888347	2SD 964 169-111	1584242-00	2PG 964 295-011
0417068-00	1K2 006 147-031	0417510	2KA 003 389-068	0888347	2SD 964 169-117	1584242-00	2PG 964 295-011
0417076	8RA 003 326-031	0417520	2SD 002 582-021	0888926	2PS 964 295-001	1584270	2SR 009 001-061
0417085	9EL 146 887-001	0417520	2SD 002 582-021	0888926	2PS 964 295-007	1584270	2SR 009 001-067
0417088	6NM 004 375-541	0417521	2SD 002 582-011	0889346-00	2BA 008 221-001	1584270-00	2BA 009 001-071
0417088-00	6NM 004 375-541	0417521	2SD 002 582-017	0889346-00	2BA 008 221-007	1584270-00	2BA 009 001-077
0417105	2PF 004 081-107	0417522	9EL 112 741-001	0889347	2BA 008 221-041	1584277-00	2BA 009 001-191
0417127	2PG 003 057-011	04175225	9EL 136 819-031	0889347	2BA 008 221-047	1584285-00	2ZR 965 039-047
0417127-00	2PG 003 057-011	0417523	9EL 112 743-001	0889348	2SA 008 405-011	1584285-00	2ZR 965 039-047
0417133	2VP 007 502-127	0417524	2VP 006 040-121	0889348	2SA 008 405-017	1584360-00	2KA 004 331-061
0417133-00	2VP 007 502-127	0417524	2VP 006 040-127	0889349	8RA 008 405-001	1584360-00	2KA 004 331-067
0417134	2VA 007 502-117	0417525	2VA 006 040-077	0889349	8RA 008 405-007	15844-00	8RA 343 220-017
0417134-00	2VA 007 502-117	0417525	2VA 006 040-077	0889350-00	8XU 008 405-031	158447-00	8RA 343 220-017
0417135	2DA 007 421-001	0417526	9EL 136 825-011	0889350-00	8XU 008 405-037	1603 12 2	2PF 003 014-071
041713500	2DA 007 421-001	0417527	9EL 136 819-031	0889351	2ZR 008 221-051	1622453	9GT 343 367-002
041713500	2DA 007 421-001	0417572-00	2XS 005 020-057	0889351	2ZR 008 221-057	1622453-00	9GT 343 367-002
0417162	2PG 006 717-021	0417572-00	2XS 005 020-137	0889352	2NE 008 221-031	1640519	1AL 009 998-001
0417162	2PG 006 717-027	0417623	2SK 003 567-321	0889352	2NE 008 221-037	1640520	2PT 009 599-141
0417164	2XT 007 945-027	0417630	2SK 003 567-331	0889353	2XA 008 221-021	1640521	2PT 009 599-131
0417169-00	9GD 963 281-001	0417633	2SK 003 567-331	0889353	2XA 008 221-027	1640522	9AH 165 968-001
0417185-00	2PF 003 563-151	0419016	8GP 003 594-141	0889354	2DA 959 071-237	1663214	2BA 009 001-201
0417186	2VP 007 502-041	0850001	8GA 006 841-121	0889728-00	8WT 008 549-201	1663214-00	2BA 009 001-201
0417186-00	2VP 007 502-041	0850001	8GA 006 841-123	0889743	8XX 010 315-001	1663215-00	9XD 161 119-007
0417194	2VA 007 502-011	0864783	8RA 003 326-041	0889744-00	1AL 008 934-001	1673707	8RA 343 160-022
0417194	2VA 007 502-017	0864783	8RA 003 326-047	091194	9FF 138 324-001	1673707	8RA 343 160-027
0417200	2KA 001 622-001	0864784	4RA 003 530-051	1017230	2VP 007 502-127	1673707-00	8RA 343 160-022
0417204	8GH 002 089-133	0864818	2KA 003 389-061	1053947	2PS 964 295-001	1683868	8RA 343 160-027
0417204	8GH 002 089-136	0864818	2KA 003 389-062	1053947	2PS 964 295-007	1683868	2PT 010 043-021
0417212-00	2KA 005 049-008	0864818	2KA 003 389-068	1201227	2KA 005 049-011	1683868-00	2PT 010 043-021
0417220	2KA 001 378-127	0864825-00	2AA 003 257-041	1201227	2KA 005 049-017	1683869	2PT 010 043-011
0417241	2DA 008 136-017	0864825-00	2AA 003 257-042	1201227-00	2KA 005 049-008	1758324	8GS 007 949-261
0417243	2DA 007 541-001	0864945-00	8GM 002 092-121	1201227-00	2KA 005 049-017	1778984	2VP 343 520-011
0417243-00	2DA 007 541-001	0865031-0	2AB 004 532-001	1201688	2XS 008 479-011	1778984	2VP 343 520-017
0417244	2BN 964 169-051	0865031-0	2XS 005 020-002	1201688-00	2XS 008 479-011	1778985	2VP 343 520-021
0417244	2BN 964 169-057	0865031-0	2XS 005 020-002	1201688-00	2XS 008 479-011	1778985	2VP 343 520-027
0417244-00	2BN 964 169-051	0865205-00	2PF 001 638-011	1201689-00	2XS 008 479-017	1778988	8RA 344 065-007
0417244-00	2BN 964 169-057	0865263-00	2BM 006 692-011	1201689-00	2XS 008 479-001	1862653	8XX 010 315-101
0417248	2TA 964 169-061	0865264-00	2BM 006 692-017	120689-00	2XS 008 479-007	1862653-00	8XX 010 315-101
0417248	2TA 964 169-067	0865264-00	2BM 006 692-021	1209410-00	8GP 003 594-121	1950679	2PS 344 690-617
0417248-00	2TA 964 169-061	0865453	2PS 962 964-037	1268097	8GP 003 594-121	1950680	9GS 343 697-107
0417248-00	2TA 964 169-067	0865453	2PS 962 964-031	1268097	2BM 008 771-001	1950680-00	9GD 343 697-107
0417249	2DA 008 136-007	0865453-00	2PS 962 964-037	1268097-00	2BM 008 771-007	2020767	9BE 010 102-101
0417252	2PG 964 295-011	0865454	2BA 003 236-541	1268097-00	2BM 008 771-007	2155150	2PS 344 690-617
0417254	2PG 964 295-017	0865460-00	2VP 007 323-011	1280755-00	2BM 008 771-007	2375478	2NE 344 610-027
0417254-00	2PG 964 295-011	0865461-00	2XS 005 020-077	1280761-00	8WS 008 549-001	2375478-00	2NE 344 610-027
0417254-00	2PG 964 295-017	0865462-00	2XS 005 020-077	1280762-00	1K0 008 192-001	3000801	2XW 003 146-001
0417285-00	2DA 959 071-037	0865485-00	9GT 963 129-001	1280762-00	1K0 008 192-007	41 710	2PF 003 057-001
0417286	2PS 007 943-311	0866789	2ZR 003 236-051	1282574	1BL 008 194-001	41 737	8RA 002 020-001
0417286							



Manufacturer's no. / HELLA no.

Cross-Reference

Hymer France	HELLA	IHC	HELLA	Ikarus	HELLA	Iveco	HELLA
8003712-00	2PS 964 295-061	3 215 666 R 1	9EL 111 647-001	70004-54007	9GH 152 654-007	1119 943	9XS 027 639-001
8003712-00	2PS 964 295-067	3 215 670 R 1	9EL 107 368-001	70004-55001	2BM 008 355-001	1162 800KZ897646	2ZR 001 193-011
8005351-00	2PF 008 221-011	3 221 211 R 91	2BE 002 582-031	70004-55001	2BM 008 355-007	1169 440EF897680	2AA 001 201-011
8005351-00	2PF 008 221-177	3 222 387 R 1	2BA 002 652-111	70004-60307	2BA 005 603-001	1262 462EZ877680	2AA 001 204-031
8005352-00	2DA 343 106-011	3 222 387 R 1	2BA 002 652-117	70004-60307	2BA 005 603-007	1262 567EZ877680	2AA 001 204-001
8005352-00	2DA 343 106-017	3 222 388 R 1	8XS 113 389-001	70004-64011	2PS 962 964-012	1275 886	9GT 067 751-001
8005357-00	1K0 008 191-047	3 222 389 R 1	2BA 002 652-121	70004-64011	2PS 962 964-018	1275 886EY4875180	9GT 067 751-001
8005357-00	1K0 008 191-047	3 222 427 R 1	2BA 002 652-127	70004-64012	9GT 963 129-001	1275 982EY875180	9EL 092 435-011
8005359-00	1AL 008 934-021	3 223 263 R 91	2KA 001 386-231	70004-67011	9GD 963 281-001	1276 008	9GD 024 183-001
8005360-00	1N0 008 582-011	3 223 263 R 91	2SD 002 776-231	70004-67021	2SA 961 167-011	1276 024	9KS 075 307-001
8005360-00	1N0 008 582-017	3 223 264 R 91	2SD 002 776-237	70004-69001	2PF 961 167-021	1286 471	2SB 003 014-151
8005364-00	8JA 990 295-127	3 223 264 R 91	2SD 002 776-241	70004-69001	2DA 964 169-001	1715 77	2XW 003 146-001
8007918	1N0 009 295-041	3 224 290 R 1	2SD 002 776-247	70004-69001	2DA 964 169-007	1715 78	2AB 004 532-001
8007918	1N0 009 295-041	3 226 119 R 1	9EL 112 744-001	70004-69011	2BA 964 169-011	1819 37	2VP 003 567-121
8007918	1N0 009 295-031	3 226 119 R 1	2BE 002 776-251	70004-69011	2BA 964 169-017	1819 37	2VP 003 567-127
8007919	5DF 009 245-007	3 226 120 R 1	2BE 002 776-257	70004-69021	2NE 964 169-021	1978 95	2SD 001 306-061
8007965	1K0 008 191-011	3 231 089 R 91	2KA 001 386-281	70004-69021	2ZR 964 169-031	230 6632KZ1001-49	2SE 001 306-051
8007965	1K0 008 191-017	3 231 505 R 91	2KA 003 389-061	70004-69031	2ZR 964 169-037	233 2194E-1001-49	9EL 104 571-041
8007965-00	2PF 003 563-177	3 231 505 R 91	2KA 003 389-062	70004-69081	2SW 964 169-081	233 2197E-1001-49	9EL 104 571-031
8007966	2BA 965 039-061	3 231 505 R 91	2KA 003 389-068	70004-69081	2SW 964 169-087	233 9143KZ1210-49	2BA 001 259-611
8007966	2BA 965 039-067	3 231 644 R 91	2ZR 003 734-041	70004-69091	2SA 964 169-091	233 9143KZ1210-49	2BA 001 259-631
8007966-00	2BA 965 039-061	3 231 789 R 1	2JA 001 330-001	70004-69091	2SA 964 169-097	237 2740KZ1210-49	2PF 001 259-631
8007966-00	2BA 965 039-067	3 231 789 R 1	2JA 001 330-007	70004-71737	2DA 959 071-737	237 2742KZ1210-49	2BE 001 259-061
8007968	2PS 009 226-011	3 404 170 R 91	1AA 004 109-021	70004-86047	1NL 007 186-047	237 7137 KZ1001-49	2SD 002 776-247
8007968-00	2PS 009 226-027	3 404 745 R 91	2BE 003 182-091	70004-91027	1K0 008 191-027	237 7137 KZ1001-49	2SD 002 776-247
8007968-00	2PS 009 226-027	3 404 746 R 91	2BE 003 182-101	70004-91027	1K0 008 191-027	237 7448KZ1001-49	2BE 002 776-251
8007969	1K0 008 191-011	7 161 60R 1	9ES 012 060-011	70004-93017	1BL 008 193-011	237 7448KZ1001-49	2BE 002 776-257
8007969	1K0 008 191-017	7 161 61R 1	9GD 023 639-001	70004-93017	1BL 008 193-017	237 7450KZ1001-49	2BE 002 776-267
8007969	1K0 008 191-017	7 161 62R 1	9KS 075 139-001	70004-93114	2DA 007 421-001	237 7450KZ1001-49	2SE 002 776-217
8008152-00	8WS 006 549-001	7 162 40R 1	9KS 071 571-001	70004-93115	8KA 146 751-007	2377 139KZ1001-49	2SE 002 776-217
8009457	2XT 008 929-001	7 162 41R 9 1	9BR 090 206-001	70004-93168	2SA 005 603-021	238 1669EZ1210-49	9EL 109 208-011
8009457	2XT 008 929-007	7 171 41R 9 1	2AA 001 200-021	70004-93168	2SA 005 603-027	238 1675EZ1210-49	9EL 088 538-001
8015916	2BM 008 771-001	7 171 41R 9 1	2AA 001 200-023	70004-93169	ZZR 005 603-061	238 9569KZ1001-49	2SE 002 776-211
8015916	2BM 008 771-007	9 253 05C 9 2	2SD 001 680-281	70004-93169	ZZR 005 603-067	238 9569KZ1001-49	2SE 002 776-241
8015920	1AL 009 998-001	9 253 06C 9 2	2SE 001 680-291	70004-93170	2NE 005 603-071	238 9571KZ1001-49	2SD 002 776-247
8015921	6NM 007 282-221	9 280 44C 1	8JA 001 909-011	70004-93209	2DA 005 603-031	2426 141	8JA 001 914-011
8016152	9AH 169 580-011			70004-93209	2DA 005 603-037	248 1978KZ5026-80	2NE 001 423-011
8016156	1AL 009 997-001			70004-93210	2BA 005 603-011	248 1980KZ5026-80	2ZR 001 423-001
8016162	2PT 009 496-007			70004-93210	2BA 005 603-017	2480 751	2SE 001 699-071
8016166	2KA 959 640-102			70004-93260	2BM 006 692-011	2480 978	2SD 001 699-061
8020100	9XB 136 202-005			70004-93260	2BM 006 692-017	2481 980	2NE 001 423-011
8020239	5DV 008 855-001			70004-93261	2BM 006 692-021	2481 982	2ZR 001 423-001
8020239	5DV 008 855-007			70004-93261	2BM 006 692-027	250 6751KZ5024-80	2ZR 001 240-351
8025470	2PT 010 043-011			70004-93293	1GA 007 506-001	250 6753KZ5025-80	2BA 001 240-301
8025969	2PT 010 043-021			70004-93293	1GA 007 506-002	250 6755KZ5026-80	2SB 001 240-311
8043362	5DS 011 630-001			70004-93293	1GA 007 506-007	250 6757KZ5026-80	2DA 001 240-341
938148	8RA 003 326-011					2506 751	2ZR 001 240-351
938148	8RA 003 326-017					2506 753	2BA 001 240-301
9417551	9EL 120 240-011					2506 759KZ5027-80	2SA 001 240-331
9920560	8JB 004 777-001					2525 487	6EG 001 567-041
9920560	8JB 004 777-002					2525 995	2KA 001 386-231
9942450	2JA 003 231-011					259 3628KZ5762-76	2SD 001 693-011
9942450	2JA 003 232-011					260 0655KZ5508-76	2BA 003 022-021
9942700	2JA 003 254-001					260 0659EZ5508-76	9EL 116 907-001
9947320	8JB 001 943-001					2628 233	2BA 003 022-001
9952870	2SD 004 460-017					263 3999KZ5508-76	2BA 003 022-001
9952880	2SD 006 040-161					2633 999	2BA 003 022-001
9952880	2SD 006 040-167					2751 193	1GS 001 523-021
9952890	2SD 006 040-031					2780 621	9EL 852 061-001
9952890	2SD 006 040-037					2781 601	2BA 003 014-011
9952910	2PF 003 057-041					2831 1004	8GP 002 067-241
9952920	9EL 117 330-001					2831 2024	8GA 002 071-241
9952930	2PF 004 081-001					2831 2027	8GA 002 071-251
9952930	2PF 004 081-007					2831 8002	8GH 002 089-251
9952940	2PF 004 081-107					2831 8002	8GH 002 089-253
9953090	2XS 005 020-001					2914 462K1125-49	2SB 001 301-021
9953090	2XS 005 020-002					296 7157EE5107-80	9GT 074 132-001
9953090	2XS 005 020-003					296 9513EY5023-80	9DF 112 246-001
9953700	2SD 004 460-011					296 9580EY5762-80	9EL 110 737-001
9953700	2SD 004 460-017					2967 157	9GT 074 132-001
9957400	2NE 006 609-001					2967 457	9GT 074 132-001
9957400	2NE 006 609-007					298 4108KY8751-80	2BA 002 324-011
9957440	8RA 003 326-047					298 4109KY8751-80	2BA 002 324-021
9957440	8RA 003 326-047					2984 106	2SD 001 686-101
9959360	8GP 003 594-141					2984 107	2SE 001 686-142
9959370	8GP 002 067-121					2984 108	2BA 002 324-011
9959370	8GP 002 067-123					2984 397	9DR 060 567-001
9974670	9EL 146 491-001					2984 403	9EL 102 240-031
9974860	2SE 002 578-701					3385 820M01A	2JA 001 357-002
9974860	2SE 002 578-707					341 672KZ5026-80	2SD 001 688-141
9975200	2PF 003 057-001					3416 605	8JA 001 909-011
997555	8JA 001 930-001					3416 605	8JA 001 914-011
						3440 754	9GD 100 140-001
						345 1057KZ5736-78	2ZR 001 240-351
						3464 801	8HG 002 365-001
						3466 213	2KA 001 386-301
						3476 687	2AA 001 200-001
						3476 688	2AA 001 200-011
						3476 688	2AA 001 200-012
						3476 689	2AA 001 200-021
						3476 689	2AA 001 200-023
						3478 683	9PF 085 642-001
						3502 400	1A3 001 120-001
						3505 853	2AA 001 200-031
						3517 928	2RL 007 017-071
						3522 674	2AB 001 208-001
						3540 288	1G3 996 001-331
						3814 569	9GD 856 863-001
						4105 4985	2PS 003 748-121
						4105 4985	2PS 003 748-127
						4120 0525	2SE 001 685-201
						4120 0526	2SD 001 685-211
						4120 0526	2SD 001 685-218
						4120 0761	1G3 005 760-021
						4120 0761	1N8 007 060-021
						4120 0762	2RL 008 063-111
						4120 07	

Manufacturer's no. / HELLA no.

Cross-Reference



Iveco	HELLA	Iveco	HELLA	Iveco	HELLA	Iveco	HELLA
4162 2525EE6927-13	2ZR 003 014-091	4230 4487	2NE 003 236-008	5006 143111	1K0 008 191-021	R000 70525	1EA 993 975-057
4162 2580	2JA 007 373-107	4230 4488	2ZR 003 236-051	5006 143111	1K0 008 191-027	J.C.B.	HELLA
4162 3679	2KA 001 389-101	4230 4488	2ZR 003 236-057	5006 143113	2BA 008 221-001	Services Ltd.	
4162 3679	2KA 003 389-061	4230 4488KZ5763-76	2ZR 003 236-051	5006 143131	2BA 008 221-007		
4162 3679	2KA 003 389-062	4230 4488KZ5763-76	2ZR 003 236-057	5010 043471	2AB 004 532-051	34720596	1GA 996 361-447
4162 3679	2KA 003 389-068	4231 7738	2ZR 003 236-051	5010 043471	2AB 004 532-057	700/23000	1GA 998 522-011
4162 3979	2JA 007 372-001	4231 7738	2ZR 003 236-057	503 334551	8RA 004 412-001	700/31800	1GA 996 082-001
4162 4870	6ZE 001 759-071	4232 5601KZ5508-78	2XS 005 020-001	5031 27214	1KL 007 834-027	700/32200	1GA 006 991-041
4162 4924	2NE 006 609-001	4232 5601KZ5508-78	2XS 005 020-002	5031 27216	8GH 002 089-251	700/34600	1GB 996 080-001
4162 4924	2NE 006 609-007	4232 5601KZ5508-78	2XS 005 020-003	5031 27216	8GH 002 089-253	700/34700	1GA 006 991-041
4162 4928	2ZR 006 609-081	4232 8351	2BM 002 652-031	5031 27219	1NL 007 834-017	700/35200	1GA 998 522-011
4162 4928	2ZR 006 609-087	4233 1327	8RA 003 660-007	5031 27226	8GA 006 841-241	700/38800	1GA 007 506-001
4162 5266	1GB 006 213-111	4234 0069	2JA 001 357-002	5031 27229	8GP 003 594-251	700/38800	1GA 007 506-002
4162 5266	1GB 006 213-117	4234 0069KZ550	2JA 001 357-002	5031 27262	8GA 002 071-241	700/38800	1GA 007 506-007
4162 8725	2SD 003 167-011	4235 0859	2AB 004 532-051	5031 28360	2KA 005 049-011	700/40400	1GB 996 080-011
4162 8726	2SD 003 167-021	4235 0859	2AB 004 532-057	5031 70131	2KA 005 049-011	700/42300	1GB 996 080-011
4162 8727	2ZR 003 236-051	4235 0859-00ALT	2AB 004 532-051	5031 70131	1GA 996 179-001	700/42300	1GB 996 080-107
4162 8727	2ZR 003 236-057	4235 0859-00ALT	2AB 004 532-057	5031 71867	2ZR 997 506-391	700/42500	1GA 006 875-001
4162 8728	2BA 003 236-021	4235 3233	1G3 005 760-001	5031 72044	1GA 996 189-001	700/42600	1GA 006 875-001
4162 8728	2BA 003 236-027	424 84143EY5022-80	9ES 120 743-001	5031 72755	2BM 003 563-111	700/42700	1GA 006 875-001
4162 8729	2NE 003 236-001	4246 0351	9EL 110 536-001	5031 73005	2ZR 996 188-061	700/42800	1GA 006 875-001
4162 8729	2NE 003 236-008	4246 0353	9EL 122 689-021	5031 73198	1GA 996 192-001	700/43900	1GA 007 506-001
4162 9261	8HG 006 294-011	4246 0353	9EL 855 097-001	5031 73200	1GA 996 192-011	700/43900	1GA 007 506-002
41629815	2XS 005 020-011	4246 5112	9EL 857 801-001	5031 73256	2DA 343 106-011	700/43900	1GA 007 506-007
41629815	2XS 005 020-017	4246 5196	2JA 001 330-031	5031 73256	2DA 343 106-017	700/50022	1GA 007 506-001
4163 2525	2ZR 003 014-091	4248 4143	9ES 120 743-001	5031 74013	2AB 004 532-001	700/50022	1GA 007 506-002
4163 4740	2BA 002 652-111	4248 4762	2AA 001 200-131	5031 99319	8GH 002 089-251	700/50022	1GA 007 506-007
4163 4740	2BA 002 652-117	4248 4769	9EL 119 544-031	5032 53887	8HG 990 263-111	700/50029	1GA 007 506-391
4163 4740E26927-04	2BA 002 652-111	4248 6467	9GD 007 883-355	5032 53903	9GH 993 984-001	700/50063	1GA 007 506-651
4163 4740E26927-04	2BA 002 652-117	4248 7086	9EL 113 324-001	5032 70042	9GD 863 033-001	700/50063	1GA 007 506-391
4163 4741	2BA 002 652-121	4248 9073	8JB 001 943-001	5032 70043	9GD 859 037-011	700/50077	1GA 996 083-001
4163 4741	2BA 002 652-127	4249 0670	9EL 120 670-001	5032 70046	2RL 008 065-001	700/50078	1GA 996 083-001
4163 4741E26927-04	2BA 002 652-121	4253 0460	9EL 146 491-001	5032 70051	2JA 007 373-117	700/50081	1GA 996 161-281
4163 4741E26927-04	2BA 002 652-127	4253 1989	9EL 115 630-001	5032 70058	2PS 008 645-981	700/50082	1GA 996 161-281
4163 4742	2DA 003 014-031	4253 3016	2JA 002 651-001	5032 70077	8KB 174 943-001	700/50091	1GA 007 506-001
4163 4742	2DA 003 014-037	4255 6591	2JA 007 372-011	5032 70083	3SL 009 678-801	700/50091	1GA 007 506-002
4163 5108	1G3 005 760-221	4282 3678	2PS 002 727-001	5032 70084	8KB 175 501-001	700/50091	1GA 007 506-007
4163 5108	1G3 005 760-227	4282 3678EY8776-54	2PS 002 727-001	5032 70086	9MM 863 164-051	700/50102	1GA 007 506-001
4163 5108	1GA 005 060-001	4390	1S3 001 117-041	5032 71008	1GA 996 142-061	700/50102	1GA 007 506-002
4163 7408	8HG 854 516-001	4390 KY8751-80	1S3 001 117-041	5032 71009	1GA 996 142-001	700/50102	1GA 007 506-007
4164 0184	2BA 003 236-541	4451 42103	8GM 002 092-241	5032 90501	2JA 001 364-001	70050178	1GA 996 142-311
4168 0786	2SA 006 717-001	4452 22099	8GP 002 068-241	5032 90502	8GM 002 091-251	JHR 0151	1GA 998 522-011
4168 0786	2SA 006 717-007	4461 731	8XH 002 975-017	5032 90661	2ZR 003 014-091	JNR 0022	1GA 998 522-011
4173 0589	4RA 003 530-051	4833 768	2SA 001 259-751	5032 91373	2XS 005 020-001		
41730324	1GA 006 991-051	4833 768	2SA 001 259-757	5032 91373	2XS 005 020-002	John Deere	HELLA
418 22954EC5026-80	2KA 003 389-061	5000 2085	8GD 002 078-241	5032 91373	2XS 005 020-003	00 13 34	2SA 003 057-021
418 22954EC5026-80	2KA 003 389-062	5000 22085	8GD 002 078-241	5032 91603	2JA 001 364-001	00 13 35	2PF 003 057-041
418 22954EC5026-80	2KA 003 389-068	5000 821813	2KA 003 168-021	5032 92244	8GA 002 073-241	00 17 80	8RA 003 326-011
4182 2954	2KA 003 389-061	5001 021037	1BL 008 193-011	5032 92359	1GA 996 188-021	00 17 80	8RA 003 326-011
4182 2954	2KA 003 389-062	5001 021037	1BL 008 193-017	5032 93499	2AB 004 532-001	00 36 11	2BA 003 014-011
4182 2954	2KA 003 389-068	5001 021038	1NL 007 186-047	5032 94082	2RL 008 061-011	00 45 40	2ZR 003 030-171
4182 3454	2ZR 001 193-011	5001 021039	2PF 961 167-021	5032 94083	2RL 006 846-111	00 49 02	2JA 004 531-011
419 33709KZ6927-13	2ZR 003 030-171	5001 021044	2PS 962 964-012	5032 90593	2XS 005 020-011	01 22 36	2DA 002 324-001
4191 4894	1GA 007 506-021	5001 021044	2PS 962 964-018	5032 90593	2XS 005 020-017	01 31 72	9EL 854 912-001
4193 3709	2ZR 003 030-171	5001 021044	2BM 008 355-001	5033 34553	8RA 004 412-011	01 43 75	8JA 003 526-001
4195 2452	2XW 003 146-001	5001 021044	2BM 008 355-007	5033 34554	8RA 004 412-021	01 52 04	2AB 004 532-021
4199 1420	2KA 001 386-281	5001 828678	1ND 005 700-061	5033 38132	2KA 010 278-011	01 52 10	1GS 003 241-021
4199 4651	1G9 001 523-021	5001 842626	9XB 136 202-005	5033 38381	2XD 012 160-811	01 70 51	2SB 001 673-002
4199 6531	2BA 001 416-011	5001021036	1K0 008 191-021	5040 19896	2XW 007 146-011	01 70 52	1TA 003 570-101
4199 65316729-80	2BA 001 416-011	5001021036	1K0 008 191-027	5041 27393	2SD 964 169-111	05 72 1352	2PF 003 014-071
4199 6532	2BA 001 416-021	5001021045	2BA 008 221-001	5041 27393	05 72 2006	05 72 2006	2BE 003 185-031
4199 6532E26727-80	2BA 001 416-021	5001021045	2BA 008 221-007	5801 738337	2BA 008 221-217	05 72 6806	9EL 119 397-001
4199 7529	9EL 856 416-011	5002 46293	2BE 003 014-251	5801 951236	8RA 002 014-251	05 72 6806	2BA 003 014-011
4199 7529E26700-80	9EL 856 416-011	5002 46293	2BE 003 014-257	5801 951236	8RA 002 014-252	05 72 6807	9EL 110 536-011
420 24860E25027-80	8RA 003 326-011	5002 50590	2XW 007 146-011	5801 951236	8RA 002 014-257	10 13 44	2KA 004 525-001
420 24860E25027-80	8RA 003 326-017	5002 51298	1GA 996 142-221	5801 951237	8RA 002 014-301	10 13 52	8RA 004 412-001
420 25822KZ5022-80	1AG 003 434-051	5002 51299	9XS 027 639-001	5801 959611	2BA 008 221-107	10 14 11	9GT 005 166-001
420 82136KZ7605-30	1AG 003 434-137	5002 51320	2RL 008 181-011	5802 006995	9GT 137 236-007	10 16 97	2ZR 003 014-091
4200 5186	1A6 002 395-031	5002 51321	2RL 008 181-111	5802 58137	1H3 002 456-032	10 17 26	2ZR 003 236-051
4200 5629	1A6 002 395-071	5002 51343	2RL 008 183-011	6125 8222	1N4 005 750-041	10 17 26	2ZR 003 236-057
4200 5629	1A6 002 395-077	5002 53050	1H5 998 502-002	6126 1542	2XW 002 897-051	10 17 43	2JA 003 354-001
4201 3057	2SE 003 167-031	5002 53051	8HG 998 519-002	680 966	9EL 087 769-001	10 17 45	8RA 003 326-041
4201 3058	2SD 003 167-021	5002 53078	2XD 009 475-001	6950 1644	1BL 008 193-001	10 17 45	8RA 003 326-047
4201 3059	2SD 003 167-011	5002 53079	2XD 009 475-011	6950 1644	1BL 008 193-007	10 46 1023	2KA 003 389-061
4201 3060	2SE 003 167-041	5002 53134	9SX 863 114-001	6950 1645	9AH 157 659-007	10 46 1023	2KA 003 389-062
4202 4986	2SE 001 685-201	5002 53135	8HG 863 383-001	6950 1646	1N0 008 582-001	10 46 1023	2KA 003 389-068
4202 4987	2SD 001 685-211	5002 53285	9MM 862 358-801	6950 1646	1N0 008 582-007	10 50 28	2BA 003 014-011
4202 4987	2SD 001 685-218	5002 53286	8KB 863 324-001	69501903	6NM 007 282-221	10 50 66	2NE 003 236-001
4202 5923	2SE 002 578-701	5002 54098	2RL 008 061-111	7017 0	2PS 004 361-001	10 50 66	2NE 003 236-008
4202 5923	2SE 002 578-707	5002 58137	1GA 998 534-011	7017 0	2PS 004 361-007	10 50 79	2KA 001 610-001
4204 6397	8RA 003 326-011	5002 58415	1GA 998 532-011	7017 0	2PS 006 717-051	10 51 27	8RA 003 326-001
4204 6397	8RA 003 326-017	50					



Manufacturer's no. / HELLA no.

Cross-Reference

John Deere	HELLA	John Deere	HELLA	John Deere	HELLA	Jokon	HELLA
18 06 9023	2XS 005 020-001	AL 16 6982	2BA 008 221-007	AZ 55 467	1GA 007 506-002	13.1028.500	2NE 357 029-041
18 06 9023	2XS 005 020-002	AL 16 6982	2BA 008 221-107	AZ 55 467	1GA 007 506-007	13.1029.500	2NE 357 029-141
18 06 9023	2XS 005 020-003	AL 16 6982	2BA 008 221-147	AZ 55 467	1GA 007 506-651	13.1039.000	2BA 357 029-031
19 80 8019	6ZE 001 759-051	AL 17 4364	1GM 996 134-061	AZ 55 633	2RL 007 552-001	13.1039.500	2BA 357 029-131
19 81 2023	2XS 005 020-011	AL 20 2742	1GM 996 134-321	AZ 55 633A	2RL 007 552-001	13.4001.101	2KA 001 389-101
19 81 2023	2XS 005 020-017	AL 20 2743	1GM 996 134-321	AZ 56 280	1GB 996 147-101	13.4001.101	2KA 003 168-021
21 29 4	2BA 003 022-001	AL 20 3233	1A5 003 178-231	AZ 56 322	2RL 007 552-001	13.4002.100	2KA 001 386-231
21 56 4108	9XS 027 639-001	AL 24 042	6ED 708 919-001	AZ 56 595	2JA 001 330-031	13.4002.130	2KA 001 386-281
22 06 0068	9EL 122 772-001	AL 24 544	2SD 002 582-011	AZ 57 444	8RA 003 326-031	13.4006.120	2KA 003 389-061
24 22 6019	8JB 004 777-001	AL 24 544	2SD 002 582-021	AZ 59 789	1GM 996 134-061	13.5001.000	2KA 003 389-001
24 22 6019	8JB 004 777-002	AL 24 545	2SD 002 582-021	AZ 59 789	1AB 006 213-001	13.5003.000	2PF 001 634-101
24 23 0067	2JA 004 531-001	AL 24 547	2SD 002 582-027	AZ 59 958	1GA 007 506-061	13.6026.000	2PF 001 648-161
24 95 4999	9GD 007 883-355	AL 24 547	2BA 002 652-111	AZ 61 044	2BE 997 131-081	13.6027.000	2ZR 357 029-151
46 07 0947	2SB 003 018-355	AL 24 548	2BA 002 652-121	AZ 61 047	1EA 990 185-021	16.0005.012	2RL 006 846-001
46 07 1425	9EL 089 114-001	AL 24 548	2BA 002 652-127	AZ Y1 0001	9MN 860 677-001	19.0003.000	2RL 006 846-011
50 50 83	9EL 052 476-001	AL 25 537	2BA 002 652-101	AZ Y7 0622	2XS 950 071-031	19.0007.000	9EL 118 633-001
50 50 95	9EL 112 743-001	AL 25 537	2BA 002 652-107	AZ Y7 53658	1VB 005 444-037	19.0003.200	9EL 119 397-001
50 50 96	9EL 112 741-001	AL 25 877	2BA 002 652-107	AZ Y7 53658	9BG 127 426-001	19.0007.000	9EL 129 519-001
50 51 09	8RA 002 016-101	AL 25 879	2SE 002 582-071	AZ Y7 5365A	1GB 006 213-111	19.2101.002	8HG 005 436-011
50 51 12	2PF 003 057-001	AL 27 007	2PF 003 014-071	AZ Y7 5365A	1GB 006 213-107	19.2102.012	8HG 006 294-011
50 51 15	2KA 001 622-001	AL 27 008	2SD 001 693-011	AZY 75 360	1GB 006 213-107	30.0007.020	8HG 005 436-011
50 51 21	9EL 118 700-001	AL 27 010	9EL 112 743-001	CE 14 020	1AB 003 177-001	31.0001.010	9EL 859 020-001
50 51 22	9EL 118 701-001	AL 27 010	9EL 113 639-021	DD 11 491	9FF 078 830-001	31.0001.020	8RA 002 016-101
50 51 23	2XS 005 020-001	AL 27 011	9EL 110 542-001	DD 12 056	2KA 001 389-101	31.0004.010	8RA 002 023-001
50 51 23	2XS 005 020-002	AL 27 011	9EL 115 003-055	FO 05 273	2KA 001 386-281	31.0004.020	8RA 002 023-021
50 51 23	2XS 005 020-003	AL 27 012	9EL 116 844-001	FO 11 328	8GA 002 071-251	31.0004.040	8RA 002 023-011
50 51 63	2SD 002 582-011	AL 27 012	9EL 110 736-001	FO 11 371	8GA 008 901-241	31.0008.000	8RA 003 326-031
50 51 63	2SD 002 582-017	AL 27 013	9EL 110 737-001	FO 24 690	1GA 006 991-041	31.0008.020	8RA 003 326-041
50 51 64	2SD 002 582-021	AL 28 296	2SA 003 014-051	FO 246 93	2JA 003 236-357	32.0004.000	8RA 003 326-051
50 51 64	2SD 002 582-027	AL 31 621	153 001 117-041	FO 246 93	2PS 006 717-031	32.0004.002	8RL 002 009-021
50 51 69	2SD 003 184-031	AL 32 067	25B 003 014-151	FO 38 788	2PS 006 717-037	32.0004.000	8RA 003 503-001
50 51 70	2SD 003 184-041	AL 32 071	8RA 123 251-005	FO 38 788	1GA 007 506-001	61.0015.001	8RA 002 020-001
50 51 83	2SD 003 184-047	AL 32 071	2SE 003 184-011	FO 38 788	1GA 007 506-002		8JB 004 777-001
50 51 83	2DA 003 014-031	AL 32 071	2SE 003 184-017	FO 38 788	1GA 007 506-007		
50 51 84	2DA 003 014-037	AL 32 071	2KA 003 389-062	FO 38 788	1GA 007 506-011		
50 51 84	2SA 003 014-011	AL 33 161	2KA 003 389-068	FO 62 785	1GA 007 506-012		
50 51 85	2SA 003 014-051	AL 35 176	2SD 003 184-031	FO 63 368	1GA 996 142-011		
50 51 88	9EL 110 536-001	AL 35 176	2SD 003 184-037	FO 64 490	1GA 998 534-001		
50 51 89	9EL 110 540-001	AL 37 714	8JA 001 909-001	FO 63 367	1GA 996 142-071		
50 51 95	2SD 006 040-131	AL 55 738	8JA 003 526-001	L1 39 57	9GD 023 639-001		
50 51 96	2SD 006 040-137	AL 58 729	2BE 003 014-251	L1 39 58	9FF 090 500-001		
50 51 96	2SD 006 040-141	AL 58 729	2BE 003 014-257	L1 50 689	8GS 007 949-261		
50 61 51	2JA 003 354-001	AL 58 739	2BE 003 014-251	L1 76 73	9ES 012 060-011		
50 61 53	9EL 120 240-011	AL 58 739	2BE 003 014-257	L1 76 74	9KS 075 139-001		
50 65 69	8JA 001 921-102	AL 59 724	2KA 001 389-101	L1 87 03	9GD 024 183-001		
50 66 34	2AB 004 532-001	AL 60 127	2BE 003 182-091	L1 87 04	9ES 015 675-001		
53 50 50	2SE 002 578-701	AL 60 128	2BE 003 182-101	L1 87 05	9KS 075 307-001		
53 50 50	2SE 002 578-707	AL 64 593	2KA 003 738-057	L2 12 420	9GT 137 236-007		
53 53 08	2SD 003 182-061	AL 67 166	1A5 003 178-411	L3 34 63	9GD 120 670-001		
53 53 08	2SD 003 182-067	AL 67 206	2SD 002 776-241	L3 38 99	9GD 120 670-001		
53 53 09	2SD 003 182-051	AL 67 206	2SD 002 776-247	L5 69 06	9XD 132 749-005		
53 53 09	2SD 003 182-057	AL 67 207	2SE 002 776-211	L6 35 06	9EL 137 308-001		
5350661300	1GM 996 136-192	AL 67 207	2SE 002 776-217	L6 35 07	9EL 134 739-001		
55 31 5	8HG 854 516-001	AL 67 208	2SD 002 776-231	L6 35 08	9EL 137 307-001		
56 00 5	9EL 852 820-001	AL 67 208	2SD 002 776-237	LY 46 759A	8JA 001 909-001		
56 01 1	9GD 856 863-001	AL 75 338	1AB 003 177-001	R4 96 46	14038790		
56 20 9	1G4 003 470-001	AL 75 393	1GA 005 060-001	RE 19 5181	1404469		
56 21 0	1G5 003 241-021	AL Y4 0264A	1AB 003 177-071	RE 20 0798	1404469		
56 40 6	2SA 001 638-021	AL Y4 3450A	1GD 003 590-701	RE 21 9708	14048950		
56 41 7	2BA 002 652-111	AL167631	2AA 008 594-031	RE 23 3263	14087530		
56 41 7	2BA 002 652-117	AL175528	1GM 996 134-321	RE 26 9636	14290910		
56 41 8	2BA 002 652-121	AL175529	1GM 996 134-321	RE 26 9637	14429790		
56 41 8	2BA 002 652-127	AL23015	2AA 003 257-021	RE 26 9640	14433590		
56 42 9	2BA 003 022-021	AT 24 692	2AA 008 594-031	RE185880	14433590		
56 62 1	2JA 001 357-012	AT 27 371	2AA 008 594-021	WZ 26 01102	14436780		
56 63 7	2AB 004 532-001	AT 32 246	2SE 001 679-051	XA H1 34124	14436790		
56 63 8	2AB 004 532-051	AT 32 247	2SD 001 679-001	XA H1 34124	14436790		
56 63 8	2AB 004 532-057	AT130 104	8GH 002 090-133	XA H1 34125	14521627		
57 05 0	6ZE 001 759-071	AT130 104	8GH 002 090-136	XA H1 34125	14521914		
57 05 2	6ED 004 778-011	AX E1 1057	1G0 996 176-131	Z 21 973	14718660		
57 M6 274	8GM 002 092-121	AX E1 1057	1G0 996 176-137	Z 21 973	14731890		
57 M6 394	8GP 002 067-121	AX E2 0661	1G0 996 176-131	Z 21 974	14731890		
57 M6 394	8GP 002 067-123	AX E2 0661	1G0 996 176-137	Z 21 974	14731900		
57 M6 494	8GP 002 067-121	AX E2 9075	2KA 001 078-411	Z 21 975	14731900		
57 M6 494	8GP 002 067-123	AX E3 6201	2SW 003 014-131	Z 75 467	14731930		
57 M6 498	8GA 002 071-121	AXE22879	1AB 008 888-041	Z 75 468	14731930		
57 M6 498	8GA 002 071-123	AXE36203	2RL 010 979-011	Z 73 83	14731940		
57 M7 011	8GD 002 078-121	AZ 10 3535	2AA 008 594-021	Z 37 14	14733230		
57 M7 013	8GA 002 071-131	AZ 10 4309	2BM 003 563-111	Z 49 15	14735480		
57 M7 013	8GA 002 071-133	AZ 10 792	2BA 001 227-201	Z 42 80	14735700		
57 M7 014	8GA 002 073-121	AZ 100 331	1GB 996 147-101	Z 59 182	14735700		
57 M7 014	8GA 002 073-123	AZ 13 377	2PF 001 634-101	Z 57 588	14738640		
57 M7 019	8GH 002 089-133	AZ 23 618	2BA 003 014-111	Z 57 588	14739480		
57 M7 019	8GH 002 089-136	AZ 28 085	8JA 001 914-011	ZY 67 365	14739480		
57 M7 086	8GM 002 092-121	AZ 30 044	2SA 001 259-751	ZZ 10 006	14739810		
57 M7 166	8GJ 002 525-131	AZ 30 044	2SA 001 259-757		14748710		
57 M7 166	8GJ 002 525-136	AZ 31 113	1GD 003 590-701		14750640		
57 M7 182	8JA 003 526-001	AZ 34 621	8JB 850 434-011		14750640		
57 M7 504	8GM 002 091-131	AZ 35 474	2SA 003 236-041		14750780		
57 M7 615	8GM 002 092-121	AZ 35 474	2SA 003 236-048		14750780		
57 M9 328	8GH 008 358-121	AZ 39 022	1AA 004 109-001		16018360		
79 69 723	8HG 002 365-001	AZ 39 131	2XS 005 020-001		16018360		
80 79 003	2JA 003 354-001	AZ 39 131	2XS 005 020-002		16025850		
80 80 055	8RA 003 326-051	AZ 39 131	2XS 005 020-003		16028430		
80 80 082	9FF 078 830-001	AZ 41 570	1GB 006 213-107		16028440		
80 80 255	8RA 003 326-041	AZ 41 571	1GB 006 213-117		16029020		
80 80 257	8RA 003 326-047	AZ 42 982	2BE 003 347-001		16036350		
87 52 299	9GH 096 532-001	AZ 44 705	2RL 006 846-001		16172560		

Manufacturer's no. / HELLA no.

Cross-Reference



Jungheinrich	HELLA	Jungheinrich	HELLA	Karmann	HELLA	Kässbohrer	HELLA
2830071	8GA 002 074-121	50229023	8GH 002 089-133	824 418	2KA 003 389-068	7.521.170.000.0	2BA 965 039-101
28300880	2RL 008 061-111	50229023	8GH 002 089-136	827 092	2PF 003 057-001	7.521.170.000.0	2BA 965 039-107
28301140	9FF 090 500-001	50234908	8GJ 002 525-131	828 500	2SA 003 236-041	7.521.174.000.0	2BA 009 001-107
28301690	8GM 002 091-121	50234908	8GJ 002 525-136	828 500	2SA 003 236-048	7.521.175.000.0	2BE 010 102-011
28303350	2BA 003 014-011	50234909	9EL 990 267-001	828 621	8RA 002 020-001	7.521.176.000.0	2BA 009 001-511
28303540	8GA 002 083-131	50236485	9EL 856 010-001	828 621	8RA 002 020-002	7.521.408.025.0	9XR 854 840-001
28304140	8GA 002 073-241	50236747	1A3 002 850-031	Kässbohrer		7.521.420.000.0	2RL 007 337-011
28304410	8GA 002 073-248	50260000	9GH 993 984-001	HELLA		7.521.420.000.0	2RL 007 337-011
28304390	8GP 002 067-241	50275490	8GA 006 841-241	0.370.048.800	2JA 001 364-001	7.521.420.004.0	9EL 859 020-001
28304760	2JA 004 531-011	50298227	2SD 001 679-001	0.370.135.305	2JA 001 357-002	7.521.420.004.0	9EL 859 020-001
28304810	2AB 004 532-001	50308042	9EL 112 743-001	2 118 032 014 2	2PG 340 000-121	7.521.422.000.0	2RL 007 337-001
28304900	8GA 002 074-241	50308982	8JA 003 526-001	2 118 032 014 4	2PS 008 643-031	7.521.422.000.0	2RL 007 337-111
28304910	8GH 002 090-251	50381518	1E5 996 124-001	2 118 032 014 4	2PS 008 643-037	7.521.423.000.0	2RL 007 337-041
28304910	8GH 002 090-253	50409964	8GA 002 073-241	2 118 032 082 1	2ZR 001 423-001	7.521.425.000.0	2RL 006 846-001
28304910	8GH 002 090-258	50409964	2 118 032 090 4	2 118 070 001 3	2PF 340 000-111	7.521.427.000.0	2RL 007 550-011
28304940	8GA 002 071-271	50422871	2DA 996 012-041	2 118 990 102 0	8JE 340 060-001	7.522.004.000	2SW 003 014-131
28304950	2SD 003 184-031	50423345	1EA 007 108-011	2 118 990 102 1	9EL 950 315-031	7.522.010.000.0	2BA 003 236-541
28304950	2SD 003 184-037	50423345	1EA 007 108-021	2.370.009.5	9EL 950 315-061	7.525.123.000	2SD 003 184-047
28305120	8GA 002 071-248	50423346	1EA 007 108-021	3.482.311.0	2JA 003 231-001	7.525.123.000	2SD 003 184-047
28305250	2BA 003 022-021	50423346	1EA 007 108-021	36.252.25-6000	2XA 008 221-021	7.525.339.000.0	2SB 009 362-011
28305560	2PF 003 389-037	504233461	1EA 007 108-021	36.252.25-6000	2XA 008 221-027	7.526.009.000.0	2SE 006 040-011
28305710	8GP 002 095-241	50423347	1EA 007 108-027	6.008.007.97	2JA 001 364-001	7.526.009.001.0	9GD 102 484-001
28305750	9EL 854 912-001	50423347	2ZR 997 131-051	7 515 110 000	2ZR 001 193-011	7.526.010.000.0	2SD 006 040-041
28306140	2ZR 003 014-091	50423369	2ZR 002 985-261	7 515 115 000	2ZR 002 694-001	7.526.010.000.0	2SD 006 040-041
28306400	8GH 002 473-151	50423370	8GD 002 078-248	7 515 115 004	9EL 113 928-001	7.526.122.000	2SD 003 184-031
28306510	2DA 003 014-031	50427990	2XD 009 052-001	7 517 005 000	1H3 002 456-012	7.526.122.000.0	2SD 003 184-037
28306510	2DA 003 014-037	50436549	2JA 007 372-011	7 521 120 004	9EL 110 014-001	7.526.122.000.0	2SD 003 184-037
28306630	8GM 002 092-241	50451992	8GA 002 078-221	7 526 122 000	9EL 118 700-001	7.526.122.004.0	9EL 118 700-001
28306740	8HG 003 799-001	50468122	2SW 003 014-131	7 526 123 000	2SD 003 184-041	7.526.123.000.0	2SD 003 184-041
28306750	1TA 003 570-101	50468123	8GM 002 092-241	7 526 123 004	2SD 003 184-047	7.526.123.000.0	2SD 003 184-047
28306760	2SA 003 057-021	510026218	8GS 002 296-101	7 534 118 000	9EL 118 701-001	7.526.123.004.0	9EL 118 701-001
421-440051419	2BA 003 014-111	51006218	8GS 002 296-101	7 534 118 000	2PS 002 727-001	7.526.134.000.0	2SE 003 184-011
440050164	2SB 003 014-151	51006224	8GS 002 296-111	7 534 118 000	2PS 004 361-001	7.526.134.000.0	2SE 003 184-011
440056314	2KA 001 389-101	51015057	1A3 996 002-191	7 534 134 000	2PS 004 361-007	7.526.134.000.0	2SE 003 184-011
440073217	2ZR 003 014-091	51016318	2SD 343 130-397	7 534 134 000	2XS 005 020-001	7.526.134.000.0	2SE 003 184-011
440075253	8GH 002 090-133	51016328	2SD 343 130-227	7 534 134 000	2XS 005 020-002	7.526.134.004.0	9EL 118 697-001
440075253	8GH 002 090-136	51017428	1GA 996 361-421	7 534 138 000	2XS 005 020-003	7.526.319.000	2SK 003 567-331
440075509	8GM 002 091-241	51024815	1GA 996 361-431	7.312.020.000	2SA 001 634-121	7.526.319.004	9EL 122 772-001
44057072	2DA 003 014-031	51026926	9EL 862 141-001	7.512.007.010.0	1GA 998 534-011	7.526.325.000	2XL 004 762-001
44057072	2DA 003 014-037	51061360	2RL 006 846-001	7.512.029.000	6ED 004 778-001	7.526.325.004.0	2XL 004 762-001
449090012	8GM 002 092-121	51067163	10G 996 176-021	7.512.029.000.0	8JA 001 909-001	7.526.325.012.0	9EL 136 833-001
449090042	8GP 002 067-121	51074981	8GS 007 949-261	7.512.030.000.0	1AA 004 109-041	7.526.325.020.0	2SE 004 623-001
449090042	8GP 002 067-123	51074981	8GP 003 594-251	7.512.030.000.0	1AA 004 109-041	7.526.325.024.0	2SE 004 623-007
449090067	8GP 002 067-241	51079580	8GP 003 594-258	7.512.030.001.0	1AB 006 213-027	7.526.326.204.0	9EL 129 519-001
449090074	8GA 002 083-251	51079581	1AB 996 213-001	7.512.033.021.0	1AB 006 213-027	7.526.326.000.0	2SW 964 169-081
449090074	8GP 002 095-121	51079581	2BA 002 652-111	7.512.034.027.0	9BG 993 345-001	7.526.326.000.0	2SW 964 169-087
449090084	8GM 002 091-121	51079584	2BA 002 652-117	7.512.034.028.0	9BG 993 345-001	7.526.327.000.0	2NE 964 169-021
449090087	8GA 002 073-121	51079584	2BA 002 652-121	7.512.036.001.0	1BL 008 194-027	7.526.327.000.0	2NE 964 169-027
449090087	8GA 002 073-123	51097232	2BA 002 652-127	7.512.036.001.0	1BL 158 060-021	7.526.328.000.0	2SD 964 169-111
449090088	8GA 002 073-248	51111521	8GH 002 089-361	7.512.037.000.0	1KV 008 192-027	7.526.328.000.0	2SD 964 169-117
4565385	8GH 002 089-251	51111521	2PT 965 039-171	7.512.037.000.0	5DU 007 810-171	7.526.329.000.0	2SA 964 169-091
4565385	8GH 002 089-253	51113392	4DM 009 492-001	7.512.040.000.0	8HG 151 866-001	7.526.329.000.0	2SA 964 169-097
4565385	8GH 002 089-258	51114681	2ZR 003 014-091	7.512.040.028.0	1K0 008 191-021	7.526.330.000.0	2SA 965 039-081
50011267	2SE 002 578-701	51115651	2SD 343 910-027	7.512.042.000.0	1K0 008 191-027	7.526.330.000.0	2SA 965 039-087
50011267	2SE 002 578-707	51116444	2RL 008 060-111	7.512.043.000.0	1K0 008 191-027	7.526.330.000.0	2BE 343 130-777
50011268	2ZR 003 030-171	51129935	8GH 007 157-241	7.512.043.021.0	1BL 008 193-011	7.526.330.000.0	2BE 343 130-787
50011360	8GA 002 071-251	51129935	8GH 007 157-248	7.512.044.000.0	1BL 008 193-017	7.526.330.000.0	2SD 343 130-807
50011360	8GA 002 071-258	51134940	1GA 007 506-001	7.512.044.000.0	1BL 008 193-017	7.526.330.000.0	2SD 343 130-797
50012742	8GA 002 074-241	51134940	1GA 007 506-002	7.512.044.000.0	1BA 996 261-021	7.526.335.000.0	2SD 343 130-807
50015918	2SE 004 623-001	51134940	1GA 007 506-007	7.512.044.000.0	1KA 996 261-091	7.526.336.000.0	2SA 001 259-751
50015918	2SE 004 623-007	5116723	9GH 993 984-001	7.512.044.000.0	1AB 007 145-001	7.526.336.004.0	2SA 001 259-757
50035528	2SB 003 014-151	51169750	8GP 003 594-121	7.512.046.000.0	1AB 007 145-007	7.526.336.004.0	9EL 135 266-001
50035531	8GA 002 073-121	51169927	8GH 007 157-121	7.515.105.000	1AL 009 998-041	7.526.339.000.0	2SB 009 362-011
50035531	8GA 002 073-123	51169927	8GH 007 157-126	7.515.114.000	2ZR 001 240-351	7.534.101.000	2PF 001 648-171
50035540	8GP 002 095-121	51169927	8GA 006 841-123	7.515.118.000.0	2ZR 001 240-351	7.534.128.000	2PF 001 259-631
50035558	2SD 003 182-051	51170180	8GA 006 841-123	7.515.118.000.0	2ZR 964 169-031	7.534.135.000	2SA 001 240-331
50035558	2SD 003 182-057	51172458	2NE 959 011-501	7.517.127.000	2ZR 964 169-037	7.534.140.000	2PG 003 057-011
50035559	2SD 003 182-061	51172458	2NE 959 011-507	7.517.127.000.0	1GA 007 506-011	7.534.153.000	2ZR 003 236-051
50035559	2SD 003 182-067	51187837	8GP 008 285-001	7.517.127.000.0	1GA 007 506-012	7.534.153.000	2XS 005 020-011
50037209	2BA 001 177-021	51225858	2ZR 997 506-391	7.517.127.112.0	1GA 998 525-001	7.534.160.000	2XS 006 717-051
50038755	8GA 002 071-131	51234793	9GH 993 984-001	7.517.130.000.0	1GB 996 080-011	7.534.160.000	2PS 006 717-057
50038755	8GH 002 089-251	51288182	2ZR 996 188-061	7.517.131.000.0	1GA 998 534-011	7.534.191.000	2PS 964 295-051
50042037	8GH 002 089-253	52021959	2JA 006 447-041	7.517.131.102.0	5DV 990 264-011	7.534.200.000.0	2PS 964 295-057
50042037	8GH 002 089-258	52030617	2BA 004 532-031	7.517.133.000.0	1GA 007 506-111	7.534.205.000.0	2PT 965 039-171
50051471	1GA 007 506-001	52030665	8GP 002 067-241	7.517.133.0000B	1GA 007 506-121	7.534.205.000.0	2PT 965 039-177
50051471	1GA 007 506-002	Karmann		7.517.134.000.0	1GA 007 506-111	7.542.110.000	2DA 001 240-341
50051822	8GD 002 078-241	2050	2XS 005 020-001	7.517.134.000.0	1GA 996 142-071	7.544.111.000	2KA 003 389-001
50051822	8GD 002 078-248	2050	2XS 005 020-002	7.517.134.012.0	1GA 996 142-131	7.544.120.000.0	2KA 004 331-061
50052657	8JB 004 777-001	4501017	2XS 005 020-003	7.517.134.1			



Manufacturer's no. / HELLA no.

Cross-Reference

Kempf	HELLA	Kempf	HELLA	Knaus	HELLA	Knaus	HELLA
102392	2DA 343 106-017	4009005	2TJ 001 633-211	051631	2DA 007 421-001	K615217	2ZR 964 169-031
102393	2VP 340 932-011	4010015	2PS 003 748-161	051639	2DA 007 421-007	K615217	2ZR 964 169-037
102394	2VP 340 932-011	4010015	2PS 003 748-167	051639	2XS 008 479-001	K615220	9GH 147 009-007
102494	2KA 010 278-051	4021002	8RA 003 503-001	051639	2XS 008 479-007	K615225	2VA 007 502-061
102495	2XS 340 827-011	4040017	9EL 134 296-041	051639	2XS 008 479-011	K615290	2XS 008 479-081
102496	2XS 340 827-001	4040018	9EL 134 296-051	051639	2XS 008 479-017	K615290	2XS 008 479-087
102497	2XS 340 447-021	4224001	9GT 141 941-001	051651	2XS 008 479-001	K615291	2XS 008 479-091
105095	2SD 340 685-051	4226027	8KW 701 235-033	051651	2XS 008 479-007	K615291	2XS 008 479-097
105099	2KA 010 278-081	4226038	9GP 003 995-801	051651	2XS 008 479-011	K615319	2VA 007 502-061
105104	2PG 008 645-831	4301009	8GP 003 594-251	051651	2XS 008 479-017	R01010021	2DA 343 106-001
105105	2PS 008 645-891	4301009	8GP 003 594-258	051652	2PG 964 295-011	R01010021	2DA 343 106-007
112780	2VP 340 961-411	4302009	8GA 002 071-251	051652	2PG 964 295-017	R01010022	2DA 965 039-317
112781	2VP 340 961-421	4302009	8GA 002 071-258	051689	2BA 008 221-147	R01010023	2SA 965 039-307
1302023	9GD 963 281-001	4302009	8GA 002 071-271	051770	2XS 008 479-081	R01010024	2NE 965 039-327
1302024	9GT 963 129-001	4302010	8GA 002 073-241	051770	2XS 008 479-087	R01010035	2ZR 965 039-337
15991	2KA 959 640-661	4302010	8GA 002 073-248	051771	2XS 008 479-091	R01010036	2KA 001 378-041
20940	2SD 003 167-011	4302014	8GH 002 090-251	051771	2XS 008 479-097	R01010037	8RA 004 412-001
20941	2SD 003 167-021	4302014	8GH 002 090-253	051786	2VA 341 419-011	R01010039	2XS 008 479-001
20942	2SD 001 685-231	4302014	8GH 002 090-258	051787	2VA 341 419-061	R01010039	2XS 008 479-007
20942	2SD 001 685-232	4302015	8GM 002 092-241	055012	2SD 006 040-161	R01010040	2XS 008 479-011
20943	2SD 001 699-061	4302016	8GP 002 067-261	055012	2SD 006 040-167	R01010040	2XS 008 479-017
20944	2SD 001 699-511	4302018	8GA 002 071-241	055013	2SD 006 040-031	R01010052	2XS 008 479-081
20945	2VP 007 907-031	4302018	8GA 002 071-248	055013	2SD 006 040-037	R01010052	2XS 008 479-087
20945	2VP 007 907-037	4401006	2XS 005 020-021	059101	2PS 006 717-031	R01010053	2XS 008 479-091
20946	2VP 007 907-041	4402002	1G3 005 760-041	059101	2PS 006 717-037	R01010053	2XS 008 479-097
20946	2VP 007 907-047	4402003	1GA 007 506-011	059118	2XS 005 639-001	R01010055	2SA 008 221-127
20950	2SK 003 567-321	4402003	1GA 007 506-012	059118	2XS 005 639-002	R01010056	2DA 008 221-167
20951	2SK 003 567-311	71239	9XK 340 879-001	280004	2AA 001 200-021	R01010057	2BA 008 221-147
20952	2BM 006 692-011	73637	2VP 340 450-031	280004	2AA 001 200-023	R01010058	2NE 008 221-137
20952	2BM 006 692-017	73684	2PS 008 645-631	280058	2AA 003 257-021	R01010059	2ZR 008 221-157
20953	2BM 006 692-021	73724	2PS 340 000-011	280088	2AA 003 257-001	R01010060	2VP 343 590-017
20953	2BM 006 692-027	73738	2PS 008 645-611	270511	2JA 007 372-001	R01010061	2VP 343 590-027
20956	2KA 001 386-281	73804	9EL 950 315-061	605057	8GM 002 092-121	R01010062	2VP 343 590-057
20957	2KA 003 389-061	73805	9EL 950 315-031	615049	2KA 001 378-127	R01010063	2VP 343 590-067
20957	2KA 003 389-062	76873	1GA 007 506-081	615067	8RA 003 326-021	R01010079	1NO 009 295-801
20957	2KA 003 389-068	77916	9XK 340 882-001	615070	2KA 004 331-061	R01010080	2BM 008 771-001
20959	2NE 003 236-001	78292	9XK 340 883-001	615070	2KA 004 331-067	R01010080	2BM 008 771-007
20959	2NE 003 236-008	79694	9XK 340 890-001	615073	8RA 003 326-011	R01010085	1NL 008 090-021
20961	2NE 001 423-011	93393	2SD 004 431-011	615073	8RA 003 326-017	R01010085	1NL 008 090-037
20963	2ZR 003 236-051	95834	2ZR 997 506-391	615074	2XS 005 020-001	R01010089	8RA 342 014-157
20963	2ZR 003 236-057	96312	8KA 340 842-011	615074	2XS 005 020-002	R01010115	2NE 009 001-021
20965	2ZR 001 423-001	96314	8KA 340 819-001	615074	2XS 005 020-003	R01010115	2NE 009 001-027
20975	2BA 002 652-121	96316	2PG 008 645-321	615141	2PS 962 964-031	R01020174	2JA 998 560-017
20975	2BA 002 652-127	96317	2PS 008 645-301	615141	2PS 962 964-037	R01020205	8GM 002 092-121
20976	8XS 113 389-001	96318	2KA 340 828-001	61514101	9GD 963 281-001	T050051	2PS 962 964-031
20986	8RA 003 503-001	96322	2XS 302 240-051	61514102	9GT 963 129-001	T050051	2PS 962 964-037
20994	9EL 122 772-001	96322	2XS 302 241-081	61514103	8GP 003 594-141	T050051	8GP 003 594-141
21111	9GP 003 995-801	96325	9XK 340 870-007	615149	2SD 006 040-131	T050096	8RA 004 412-001
21121	8GA 002 071-261	96326	8JD 008 151-011	615149	2SD 006 040-137	T050097	2NE 006 609-011
21122	8GH 002 089-251	96372	8KA 340 818-001	615150	2SD 006 040-141	T050097	2NE 006 609-017
21122	8GH 002 089-253	96373	8KA 340 859-011	615150	2SD 006 040-147	T050753	8GH 002 090-133
21122	8GH 002 089-258	96375	8KA 340 819-001	615154	8RA 002 020-001	T050753	8GH 002 090-136
21134	8HG 002 365-001	96377	9HV 340 812-007	615154	8RA 002 020-002	T050754	8GH 002 089-133
21135	2XS 005 020-011	96623	2XS 302 240-051	6151601	9GH 147 009-007	T050754	8GH 002 089-136
21135	2XS 005 020-017	96624	2KA 340 828-001	615161	2PF 001 259-631	T050756	8GP 003 594-121
21136	2XS 005 020-021	97176	8HG 160 409-002	615166	2XT 007 945-027	T051366	2VA 007 502-011
23283	1NE 006 300-011	97193	2XS 302 241-071	615172	2SD 006 040-161	T051366	2VA 007 502-017
23381	2TF 001 259-761	97722	8KA 340 815-001	615172	2SD 006 040-167	T051368	2VA 007 502-061
23723	8RA 002 020-001	97844	8RA 004 412-001	615173	2SD 006 040-031	T051371	2XT 007 945-027
23723	8RA 002 020-002	98952	2XS 340 448-011	615173	2SD 006 040-037	T051373	2PS 964 295-001
24183	1G3 005 760-041	98953	2XS 340 448-001	615188	2VA 007 502-021	T051373	2PS 964 295-007
24390	2SE 001 685-221	99047	9EL 340 829-031	615189	2VA 007 502-011	T051559	8KA 146 751-007
24390	2SE 001 685-227	99048	9EL 340 829-021	615189	2VA 007 502-017	T051561	2DA 007 421-027
24423	9GT 141 941-001	99227	8KA 340 843-011	615192	2DA 008 136-007	T051594	2PF 003 563-151
26398	2VD 007 500-411	99318	2KA 340 828-001	615192	2DA 008 136-027	T051631	2DA 007 421-001
26399	2VP 007 500-421	99510	2KA 959 640-661	615210	2VA 007 502-117	T051631	2DA 007 421-007
27104	9GH 993 984-001	99530	8KA 340 859-001	615211	2VP 007 502-127	T051639	2XS 008 479-011
27693	2VD 007 500-111	99624	2KA 340 828-001	615214	2TA 964 169-061	T051639	2XS 008 479-017
27694	2VD 007 500-221	A57816	1GA 005 060-041	615214	2TA 964 169-067	T051651	2XS 008 479-001
28188	2SL 003 567-311	SZM15991	2KA 959 640-661	615215	2NE 964 169-021	T051651	2XS 008 479-007
32123	9XD 997 909-801	KIA	HELLA	615215	2NE 964 169-027	T051652	2PG 964 295-011
34106	2NE 964 169-341	EA35A51150	2VP 006 040-301	615216	2BA 964 169-011	T051652	2PG 964 295-017
34107	2ZR 964 169-351	EA35A51150	2VP 006 040-307	615216	2BA 964 169-017	T051786	2VA 341 419-011
34108	2SD 001 685-347	EA35A51160	2VA 006 040-291	615217	2ZR 964 169-031	T051787	2VA 341 419-061
34486	8RA 004 412-011	EA35A51270	2KA 001 386-281	615217	2ZR 964 169-037	T501786	2VA 341 419-011
35536	2XA 959 560-411	NAH34111200B	2BA 001 416-011	615220	9GH 147 009-007	T501787	2VA 341 419-061
35536	2XA 959 560-417	NAH34111300B	2BA 001 416-021	615225	8GM 002 092-121		
35752	2VD 008 204-211	NAH3411300B	2KA 001 386-281	K605057	8JA 003 526-001	175553	2XS 005 020-091
35753	2VP 008 204-201	ZK01151001	1F4 002 608-001	K605299	2K01 378-127	175653	2SA 997 027-001
35799	2RL 006 846-011	ZK01151002	1N4 002 608-021	K615049	8RA 003 326-021	175687	9EL 135 548-001
36007	2VD 008 205-011	ZK01151005	8HG 116 741-801	K615067	2KA 004 331-061	181365	2PS 004 361-001
36008	2VD 008 205-021	ZK20051001	2DA 007 428-001	K615070	2KA 004 331-067	181365	2PS 004 361-007
36402	2SA 006 717-007	ZK20051001	2DA 007 428-007	K615073	8RA 003 326-011	181366	2TM 004 361-021
36402	2SD 003 167-011	ZK70Y51001	2NE 003 030-151	K615073	8RA 003 326-017	183400	8HG 002 365-001
4001001	2SD 003 167-021	Knaus	HELLA	K615074	2XS 005 020-001	183843	2XS 005 020-021
4001002	2SE 001 685-221	050096	8RA 004 412-001	K615074	2XS 005 020-002	185017	2KA 003 389-061
4001004	2SE 001 685-227	050097	2NE 006 609-011	K615074	2XS 005 020-003	185017	2KA 003 389-062
4001005	2SD 001 685-231	050097	2NE 006 609-017	K615141	2PS 962 964-031	185017	2KA 003 389-068
4001005	2SD 001 685-232	050554	2NE 003 315-011	K615141	2PS 962 964-037	185985	9EL 854 912-001
4001008	2SD 001 699-061	050753	8GH 002 090-133	K61514101	9GD 963 281-001	186069	9EL 856 010-001
4001010	2SD 001 699-511	050753	8GH 002 090-136	K61514102	9GT 963 129-001	186070	8GS 002 296-111
4001011	2SE 003 167-031	050756	8GP 003 594-121	K61514103	8GP 003 594-141	186162	1GB 132 233-011
4001012	2SE 003 167-041	050858	2KA 001 378-041	K615149	2SD 006 040-131	187107	9DX 119 545-011
4001013	2VD 005 300-551	050891	4RA 965 400-001	K615149	2SD 006 040-137	187370	9EL 117 334-001
4001500	2VP 004 887-021	051196	2BM 006 692-011	K615150	2SD 006 040-141	187496	2XS 005 020-011
4001501	2VA 004 887-031	051299	2BM 006 692-017	K615150	2SD 006 040-147	187496	2XS 005 020-017
4002002	2SK 003 567-321	051299	2PS 962 964-031	K615154	8RA 002 020-001	1942	8JA 001 909-011

Manufacturer's no. / HELLA no.

Cross-Reference



Kögel	HELLA	Kögel	HELLA	Kögel	HELLA	Komatsu	HELLA
305192	2JA 004 531-001	61107751	8JB 001 933-031	77806	2AA 001 200-141	20K-46-31820	8RA 004 412-021
305470	2XW 003 146-001	61108853	2VP 340 950-021	77824	8GA 002 071-251	2942064M	9D5 012 060-011
307225	2XS 955 031-001	61108854	2VP 340 950-011	77824	8GA 002 071-258	2942097M	RED 090 206-001
307230	8GH 002 089-251	61110984	8HG 340 413-001	77894	2SD 001 699-511	2942098M	9K5 075 139-001
307230	8GH 002 089-253	61113344	9GD 856 863-001	77894	9GT 074 132-001	2949833M	2BA 002 324-011
307230	8GH 002 089-258	61113561	9XX 340 880-001	77896	2SD 001 685-211	2951376M	1GD 003 590-701
307231	6ED 004 778-011	61113867	9XX 340 879-001	77896	2SD 001 685-218	2961720M	9GD 024 183-001
307380	1FE 006 300-001	61114487	1AL 009 997-041	77897	2SE 001 685-201	30300300M	2BE 001 259-061
308342	1AA 004 109-031	61114488	8JD 156 151-807	77959	2SD 003 167-011	326-06-13760	2SE 003 184-101
308343	9BG 127 426-001	61115527	9HV 340 812-007	77960	2SD 003 167-021	326-06-13840	2BA 002 324-011
308782	2XS 005 020-067	61131914	2PG 008 645-641	77969	2ZR 003 014-091	416-281-1240	8HG 002 240-021
308788	8RA 002 016-101	61132175	2XD 011 557-121	78314	1A7 003 099-001	416-28-11240	8HG 002 240-021
309425	8RA 004 412-011	61300779	2VP 340 950-051	78699	2SB 003 018-031	418-06-K1910	8RA 002 016-111
310834	8JA 002 263-031	61300780	2NE 959 011-501	78739	2BA 003 022-001	418957H110	2RL 008 062-111
310986	8XT 002 117-001	61300780	2NE 959 011-507	78940	2JA 001 335-011	4201263M	1A3 996 002-161
310987	9XS 027 639-001	61301377	8JB 001 943-001	79021	2KA 003 389-001	421-06-14440	8RA 002 016-111
310988	1G9 001 523-021	61301464	2XD 010 311-001	79095	2BE 002 582-031	42106H2780	2XS 005 020-011
312241	2BA 003 236-021	61301611	2XS 340 448-001	79298	2SE 003 167-031	42106H2780	2XS 005 020-067
312241	2BA 003 236-027	61301612	2XS 340 448-011	79727	8RA 003 326-011	421-06-H7100	1AE 004 234-001
312927	2TM 003 748-011	61802171	9EL 340 829-041	79727	8RA 003 326-017	421-06-H3160	8JA 001 909-001
313644	8RA 004 412-001	6352518	2PS 008 645-717	79751	1AB 001 100-001	421-06-H7100	2KA 003 389-061
313686	1AB 004 231-001	64208463	2KA 012 271-061	79914	2SK 003 567-331	421-06-H7100	2KA 003 389-068
313852	8HG 006 294-021	64208463	2KA 012 271-067	79915	2SK 003 567-321	421-56-HOR99	2JA 001 364-001
313854	2TM 003 057-031	64212497	8JA 001 909-001	79916	2SL 003 567-311	421-56-H2430	2JA 002 661-001
313855	2PG 003 057-011	6502171	9EL 340 829-051	79940	2SD 003 167-521	421-957-H1440	2RL 008 061-111
313858	8JA 001 915-001	6502172	9EL 340 829-061	80069060	2VP 340 450-141	4220 512 M91	1GA 005 060-001
314140	2PF 003 057-041	6502507	2RL 006 846-011	80069061	2VP 340 450-151	4225 06-K1291	2BA 002 652-111
316573	1AB 006 213-001	6602845	8KA 340 816-041	80069062	9EL 340 208-021	4225-06-K1301	2BA 002 652-121
317549	2PF 001 259-677	6602861	8KA 340 842-001	80069063	2VP 340 450-141	4240149M	1GB 006 213-101
317777	1NE 006 300-051	6603058	8KA 340 822-071	80069064	2VP 340 450-151	4241028M	1AB 004 231-001
319091	9EL 856 418-001	6603078	2VP 340 450-511	80069349	8RA 003 326-031	4241358M	1EA 007 108-011
320263	1G8 002 340-001	6603079	2VP 340 450-511	80069483	2AB 004 532-051	4241359M91	1EA 007 108-021
321067	1GD 003 590-701	6603082	2SD 001 685-232	80069483	2AB 004 532-057	4245981M	1A3 996 026-021
322160	2BM 006 692-021	6603173	9XX 340 883-001	80075078	2SD 001 685-231	4246417M	2RL 006 846-011
322160	2BM 006 692-027	6603177	9XX 340 880-001	80075078	2SD 001 685-232	4246418M	8HG 006 294-021
322161	2BM 006 692-011	6603179	9XX 340 872-007	80076837	2JA 001 330-001	427-06-23150	1EA 993 975-091
322161	2BM 006 692-017	6603180	9XX 340 884-001	80076837	2JA 001 330-007	427-06-23150	1EA 993 975-101
322825	2VP 004 897-021	6603181	9XX 340 881-001	80077959	2SD 003 167-011	427-06-23150	1EA 993 975-107
322826	2VB 004 887-011	6603185	9XX 340 882-001	80077960	2SD 003 167-021	4270623160	1EA 993 975-091
322969	2JA 003 354-051	6603186	9XX 340 879-001	80079005	2BE 002 582-031	4270623160	1EA 993 975-097
323235	2BA 002 652-111	6603221	8KW 998 602-002	80080370	2NE 001 423-011	4270623160	1EA 993 975-101
323235	2BA 002 652-117	6603222	9XX 340 870-007	80187496	2XS 005 020-011	427-09-H0380	2XW 003 146-001
323236	2BA 002 652-121	6603223	9HV 340 812-007	80187496	2XS 005 020-017	42U-06-13100	1EA 993 975-021
323236	2BA 002 652-127	6603224	9XX 340 871-007	80307230	8GH 002 089-251	42U-06-13100	1EA 993 975-027
323759	1AB 006 213-001	6603275	8JE 340 151-001	80307230	8GH 002 089-253	42U-06-13110	1EA 993 975-011
323759	1AB 006 213-011	6603322	1GL 008 090-211	80307230	8GH 002 089-258	42U-06-13110	1EA 993 975-017
323782	2PG 006 717-021	6603322	1GL 008 090-217	80308343	9BG 127 426-001	42U-06-19120	8HG 006 294-021
323782	2PG 006 717-027	6603347	1NL 008 090-117	80313686	1AB 004 231-001	42U0619140	2RL 006 846-001
323909	2SK 003 567-651	6603527	8KA 340 859-011	80323236	2BA 002 652-121	42U-06-HOP01	8GH 002 089-133
323910	2SK 003 567-661	6603528	2BA 008 260-001	80323236	2BA 002 652-127	42U-06-13140	9GH 993 988-007
324411	9EL 141 135-021	6603528	2BA 008 260-007	80324945	9EL 340 201-001	42U-957-1110	8HG 006 294-011
324945	9EL 340 201-001	6603532	8HG 340 413-001	80325879	2JA 340 111-001	42Y-06-H3050	8RA 004 412-001
325274	1NE 006 300-011	6603599	8KA 340 818-011	80329410	8KL 340 050-001	42Y-06-H3190	2VP 006 040-111
325879	2JA 340 111-001	6603658	2SB 964 169-531	80331466	1AA 004 109-041	42Y-06-H3190	2VP 006 040-117
326738	8KL 340 050-001	6603658	2SB 964 169-537	80332789	2PS 340 000-021	42Y-06-H3200	2VP 006 040-121
328480	8GM 002 091-251	6603733	8HG 340 489-001	80333075	2PG 340 000-121	42Y-06-H3200	2VP 006 040-127
329310	2BA 002 324-001	6603746	2VP 340 930-101	80333079	2PF 340 000-111	42Y-06-H3220	9GD 102 484-001
329410	8KL 340 050-001	6603747	2VP 340 930-111	80333423	2SK 340 101-011	42Y-06-HOP01	9EL 136 825-001
329412	8KL 340 050-011	6603856	2XS 340 827-131	80333476	9XX 340 222-001	42Y-06-HOP02	9EL 136 825-011
330431	2AB 004 532-031	6603857	2XS 340 827-121	80333481	9XX 340 220-001	4901618M	2BA 002 652-101
331466	1AA 004 109-041	6604331	2VP 340 942-101	80333483	9XX 340 223-001	4901631M	2JA 001 330-001
332789	2PS 340 000-021	6604332	2VP 340 942-111	80333485	1GA 007 506-001	4901699M	2AA 001 201-011
332790	2PS 340 000-171	6604369	8PE 008 932-001	80333485	1GA 007 506-002	4917453M	9EL 134 659-001
332792	2PS 340 000-011	6604417	2XS 302 240-031	80333485	1GA 007 506-007	4917455M	9EL 134 660-001
333075	2PG 340 000-121	6604422	9EL 340 829-031	80334516	2ZR 001 423-001	4918463M	1AA 004 109-041
333079	2PF 340 000-111	6604423	9EL 340 829-021	80342734	2JA 005 590-001	4918464M	9EL 113 639-021
333402	2SK 340 101-011	6604427	2ZR 997 506-391	80349008	2PS 008 643-011	4919157M	1AA 143 897-011
333423	2SK 340 101-011	6604568	2VP 340 940-101	80349008	2PS 008 643-017	4919701M	8GH 002 089-133
333476	9XX 340 222-001	6604569	2VP 340 940-111	80349009	2PS 008 643-021	5036014	1GA 006 991-041
333477	2SK 340 101-001	6604938	8KA 340 819-121	80349009	2PS 008 643-027	5048844	1GA 998 534-011
333478	2SK 340 101-001	6608155	9EL 303 981-011	80358125	8JB 004 777-001	5213587	1GA 996 196-031
333481	9XX 340 220-001	6608999	9EL 303 931-101	80358125	8JB 004 777-002	5213588	1GA 996 196-051
333483	9XX 340 223-001	6609000	2VP 340 931-111	80359246	9GH 993 984-001	566-06-6A720	8GH 002 089-251
333485	1GA 007 506-001	6609687	2VP 340 942-001	80368300	2RL 008 181-111		
333485	1GA 007 506-002	6609688	2VP 340 942-011	80370	2NE 001 423-011		
333485	1GA 007 506-007	69060	2VP 340 450-141	80372	1GA 003 470-051		
333492	2PS 340 000-011	69061	2VP 340 450-151	80903	2KA 340 118-001		
333493	2PS 340 000-041	69062	9EL 340 208-021	85000	9EL 113 324-001		
334516	2ZR 001 423-001	69063	2VP 340 450-141	85006	9EL 109 139-001		
335241	2SK 340 101-011	69064	2VP 340 450-151	86601237	2JA 007 372-011		
335242	2PS 340 000-051	69483	2AB 004 532-051	88301508	2SD 002 582-011		
339716	9EL 122 689-021	69483	2AB 004 532-057	88301508	2SD 002 582-017		
342734	2JA 005 590-001	700015935	9XX 340 220-801	88301509	2SD 002 582-027		
349008	2PS 008 643-011	70015247	2AA 003 257-041	88301509	2SD 002 582-027		
349008	2PS 008 643-017	70015247	2AA 003 257-042	88301983	2VP 003 567-111		
349009	2PS 008 643-021	70015933	2PS 340 000-011	88301984	2VP 003 567-121		
349009	2PS 008 643-027	70025522	2SD 997 131-051	88301984	2VP 003 567-127		
349010	2PS 008 643-031	70026634	1GA 996 083-001	88304287	2KA 010 278-031		
349010	2PS 008 643-037	70026636	1GA 007 506-011	88304949	8JE 340 151-001		
349014	9GD						



Manufacturer's no. / HELLA no.

Cross-Reference

Kramer	HELLA	Kramer	HELLA	Krone	HELLA	Krone	HELLA
1000000437	2BA 001 248-001	56402	9EL 119 544-111	0944011/0	2XS 005 020-021	200849600	1G0 996 476-001
1000027030	8RA 004 042-021	56428	2AA 001 204-001	0944012/0	2XS 950 071-031	200849610	1G0 996 476-011
1000027077	2TM 003 157-001	56429	2AA 001 204-011	0944013/0	2NE 003 236-001	200849620	1G0 996 476-121
1000038243	8HG 006 294-021	56430	9EL 150 965-001	0944013/0	2NE 003 236-008	200912350	2BA 009 001-001
1000051952	2JA 001 357-002	56431	9EL 150 965-001	0944015/0	2ZR 003 236-051	200912355	2BA 009 001-007
1000051956	1EA 993 975-011	56437	9ES 106 588-001	0944016/0	2ZR 003 236-057	270000940	8RA 003 326-001
1000051956	1EA 993 975-017	56450	2TM 003 178-011	0944016/0	2SE 001 699-071	270000940	8RA 003 326-002
1000051957	1EA 993 975-021	56454	2PS 004 361-001	0944017/0	2SD 001 699-511	270058860	2BE 343 130-657
1000051957	1EA 993 975-027	56454	2PS 004 361-007	0944018/0	2SD 001 699-061	270058880	2BE 343 130-667
1000096652	9GH 993 988-007	56464	9GP 003 995-801	0944019/0	2SD 001 693-011	270058890	1GA 996 161-101
1000105101	8JA 001 930-001	56465	8HG 002 365-001	0944039/0	9GT 005 166-001	270058900	1AB 996 157-081
1000106242	1EA 990 185-021	56473	2KA 001 386-281	0944040/0	9GT 074 132-001	270060240	1GA 996 261-511
1000106419	2PF 003 057-041	56474	9EL 118 700-001	0944046/0	8HG 002 240-001	270065410	1GA 996 161-351
1000109712	8GH 007 157-121	56481	8HG 006 294-021	0944062/0	8GM 002 092-241	270069770	8RA 002 016-111
1000109712	8GH 007 157-126	56486	9EL 856 416-001	0944065/0	8GP 002 068-241	270096960	2KA 010 278-311
1000136352	2SD 343 130-071	56497	2VA 006 040-077	0944067/0	8GH 002 090-251	270096960	2KA 010 278-317
1000148114	9GH 993 984-001	56497	2VA 006 040-077	0944067/0	8GH 002 090-253	270101770	8GS 009 028-111
1000148542	2VP 343 640-051	56499	9EL 136 819-031	0944067/0	8GH 002 090-258	270114840	8RA 003 326-031
1000148542	2VP 343 640-057	56508	8HG 006 294-011	0944068/0	8GH 002 090-133	270114850	8RA 003 326-051
1000148543	2VP 343 640-041	56511	8GP 003 954-121	0944068/0	8GH 002 090-136	270140670	8RA 002 014-281
1000148543	2VP 343 640-047	56513	1GA 005 060-001	0944069/0	8GA 002 071-121	3018541	8GM 002 091-131
1000151064	2KA 001 389-101	56513	1GA 005 060-001	0944069/0	8GA 002 071-123	3032121	8JD 008 151-011
1000151064	2KA 003 389-061	56514	2JA 005 590-001	0944074/0	8GA 002 071-241	3032291	2XS 955 031-017
1000151064	2KA 003 389-062	56516	9GD 858 086-001	0944074/0	8GA 002 071-248	3109.7008	9GD 157 876-007
1000151064	2KA 003 389-068	56518	1GA 006 875-001	0944090/0	9EL 109 208-011	4500.7017	2JA 010 838-001
1000151117	9GH 993 984-001	56550	2PF 001 259-631	0944095/0	9EL 122 689-021	4501.7063	2TM 008 645-951
1000152856	9EL 343 143-001	56591	9EL 136 825-011	0944095/0	9EL 122 772-051	4501.7063	2TM 008 645-957
1000152857	9EL 343 142-001	58141	2XS 955 260-001	0944096/0	9EL 147 747-001	500924579	8JA 002 263-031
1000161712	9GH 990 316-031	58141	2XS 955 260-007	0944096/0	9EL 147 747-007	500924580	8JB 001 933-031
1000167663	1GA 996 261-511	58454	1GA 006 876-001	0944100/0	9EL 950 315-001	500944015	2ZR 003 236-051
1000251148	1GA 996 189-001	58458	2PS 003 748-121	0944100/0	9EL 950 315-031	500944015	2ZR 003 236-057
1000279045	1GA 996 189-011	58458	2PS 003 748-127	0944104/0	8RA 003 326-031	500944040	9GT 074 132-001
1000322690	1GA 995 506-031	9709229	1GD 996 018-541	0944105/0	8RA 003 326-041	500944067	8GH 002 090-251
1002894445	2XD 010 311-011			0944105/0	8RA 003 326-041	500944067	8GH 002 090-253
10052899	1GA 996 261-511			0944108/0	8RA 003 326-051	500944067	8GH 002 090-258
1040500	1GA 007 506-001			0944108/0	8RA 002 016-101	500944070	8GD 002 078-241
1040500	1GA 007 506-002			0944110/0	8RA 002 016-121	500944070	8GD 002 078-248
1040500	1GA 007 506-007			0944111/0	8HG 002 240-021	500944104	8RA 003 326-031
29153	8HG 002 240-001			0944115/0	8HG 002 240-031	500944105	8RA 003 326-041
56013	2AA 001 200-011			0944131/0	8KW 701 235-033	500944105	8RA 003 326-047
56013	2AA 001 200-012			0944159/0	9EL 113 324-001	500944106	8RA 003 326-051
56014	2AA 001 200-141			0944178/0	2XS 955 031-001	500944977	2SD 001 685-231
56017	2AA 003 257-001			0944705/0	2NE 001 423-011	500944977	2SD 001 685-232
56019	2AA 003 257-021			0944977/0	2SD 001 685-231	505805106	2RL 008 060-111
56020	2AA 003 257-031			0944977/0	2SD 001 685-232	505806987	1GB 996 102-101
56038	2PG 003 748-151			110034	9ES 015 675-001	505810252	2PG 004 361-011
56040	2KA 001 389-101			110036	2PF 001 648-161	505810252	2PG 004 361-017
56041	2KA 003 168-021			14405006	2PF 001 259-631	505810617	8HG 006 294-021
56042	2KA 003 389-061			14405007	8GM 002 092-241	505811907	2PG 003 748-151
56042	2KA 003 389-062			14405015	2SD 001 693-011	505811909	2PS 003 748-161
56042	2KA 003 389-068			14405020	8GA 002 071-241	505811909	2PS 003 748-167
56047	2NE 003 236-008			200802320	8GA 002 071-248	505814052	2XS 008 078-007
56052	2TJ 001 633-211			200802330	1GA 996 142-001	505814052	2PS 008 382-001
56054	2PF 001 647-031			200807590	8GS 007 949-261	505814248	2PS 008 382-007
56054	2PF 001 647-037			200807610	9EL 115 003-011	505814248	2PS 008 382-007
56067	2SD 001 679-001			200807620	9EL 115 003-035	505815081	1ND 005 700-061
56069	2SD 001 680-281			200807620	9EL 120 224-001	505815338	2VP 340 400-151
56072	2SD 001 693-011			200807620	9EL 122 772-001	505815338	2VP 340 400-157
56075	2SD 002 582-011			200807630	9EL 859 020-001	505815339	2VP 340 400-147
56075	2SD 002 582-017			200807650	9EL 950 315-031	505816277	9GD 157 876-007
56076	2SD 002 582-021			200807660	8GH 002 089-133	505816704	8RA 003 326-011
56076	2SD 002 582-027			200807660	8GH 002 089-136	505816704	8RA 003 326-017
56077	2SD 003 167-011			200808100	9EL 859 020-101	505819077	8KA 340 841-001
56078	2SD 003 167-021			200810070	8HG 006 294-101	505819078	8KA 340 843-001
56081	2SE 001 679-051			200812300	2PG 964 295-121	505819079	8KA 340 818-011
56087	2SE 002 578-701			200812300	2PG 964 295-127	505819080	8KA 340 842-001
56087	2SE 002 578-707			200812330	2KA 010 278-321	505819081	8KA 340 816-001
56090	2SE 003 167-031			200812340	2SB 009 362-041	505819086	2PS 008 645-311
56091	2SK 003 567-321			20081235	2BA 009 001-001	505819087	2PG 008 645-331
56092	2SK 003 567-331			20081235	2BA 009 001-007	505821870	2VP 340 950-031
56093	2SL 003 567-311			200812350	2BA 009 001-001	505821871	2VP 340 950-041
56095	2TF 001 259-761			200812360	2BA 009 001-007	505822220	2TM 008 645-951
56096	2XS 005 020-001			200812360	8GA 006 841-121	505822220	2TM 008 645-957
56096	2XS 005 020-002			200812360	8GA 006 841-123	505822445	9DS 009 552-011
56097	2XS 005 020-003			200815180	2SD 001 685-627	505870268	5EL 340 208-001
56097	2XS 005 020-011			200815190	2SE 001 685-617	505870444	9EL 340 829-021
56097	2XS 005 020-017			200815780	2PF 007 205-017	505870445	9EL 340 829-031
56098	2XS 005 020-021			200818260	2RL 006 846-011	506000001	9EL 119 544-001
56100	2XS 003 168-071			200818570	8GA 002 071-241	515001750	4RA 965 400-001
56103	2XS 950 071-031			200818570	8GA 002 071-248	515011922	2KA 010 278-031
56104	2XS 955 031-001			200818590	8GA 002 071-251	515012259	8KA 340 059-001
56112	2ZR 003 236-051			200818590	8GA 002 071-258	515025360	2JA 010 838-017
56112	2ZR 003 236-057			200818600	8GA 002 073-241	515025952	1GM 996 136-192
56115	2PS 006 717-031			200818600	8GA 002 073-248	515032148	2DA 343 106-011
56115	2PS 006 717-037			200818610	8GH 002 090-251	515032148	2DA 343 106-017
56118	8GH 002 090-251			200818610	8GH 002 090-253	515032406	2VP 340 960-011
56149	8GH 002 090-253			200818610	8GH 002 090-258	515032406	2VP 340 960-021
56149	8GH 002 090-258			200818630	8GM 002 092-241	515032409	2VP 340 960-111
56188	8JA 001 925-001			200824510	2SB 959 010-317	515032410	2VP 340 960-121
56201	2SA 006 717-001			200824520	2KA 010 278-627	515032440	2VP 340 961-111
56201	2SA 006 717-007			200824550	2BE 010 102-011	515032440	2VP 340 961-021
56249	8KW 701 235-033			200824550	1AL 010 820-021	515032445	2VP 340 961-121
56263	8RA 003 326-001			200824590	1G0 996 276-767	515032457	2VP 340 961-021
56263	8RA 003 326-002			200824820	2RL 010 979-011	515035792	8XS 340 092-011
56266	8RL 002 009-021			200824830	2JA 343 570-267	515036549	2KA 010 278-071
56273	9BG 101 230-001			200824840	1AL 009 998-041	515040507	9XX 340 870-007
56297	9EL 109 139-001			200824840	1GA 996 661-001	515042982	9HV 340 812-007
56305	9EL 112 741-001			200824840	1GA 996 661-002	515048532	2TM 008 645-941
56310	9EL 113 324-001			200825060	2XT 959 510-397	515048532	2TM 008 645-947
56314	9EL 118 701-001			200825960	1GA 996 561-357	515070867	2KA 012 271-237
56316	2BM 006 692-011			200825970	1GA 996 361-447	515070868	2KA 012 271-277
56316	2BM 006 692-017			200825980	1GA 996 361-497	5327089/0	2SD 001 685-232
56316	9EL 122 772-001			200836530	9GH 331 480-001	5327094/0	2NE 003 236-001
56317	2BM 006 692-021			200837670	1GA 996 661-011	5327094/0	2NE 003 236-051
56317	2BM 006 692-027			200842540	2BA 344 130-237	5327095/0	2ZR 0

Manufacturer's no. / HELLA no.

Cross-Reference



Krone	HELLA	Kubota	HELLA	Langendorf	HELLA	Langendorf	HELLA
5358170/0	2VP 340 450-031	TA04930060	2SD 003 184-031	1134568	2PG 004 361-017	1201341	1G3 005 760-221
5358171/0	2VP 340 450-021	TA04930070	9EL 118 700-001	1134569	9EL 114 401-031	1201342	1G3 005 760-227
5385170/0	2VP 340 450-031	TA04930360	2KA 003 389-061	1134570	2PS 004 361-001	1203342	2ST 003 014-141
5385171/0	2VP 340 450-021	TA04934200	2BE 003 184-061	1134571	2PS 004 361-007	1203083	9EL 118 697-001
550000582	2TM 008 645-931	TA04934200	9EL 118 700-001	1134572	9EL 114 401-001	1204495	2RL 006 846-011
550000582	2TM 008 645-937	TA04934210	9EL 118 705-001	1134573	2PS 003 748-161	1204713	2KA 004 525-001
550014672	9EL 113 324-001	TA04934240	9EL 118 703-001	1134574	2PS 003 748-167	1207585	2VD 007 500-091
550015113	8HG 160 409-002	W270002106	2BE 002 776-261	1134575	2PS 003 748-121	1208288	1G3 005 760-021
550015328	9EL 340 203-001	W270002107	2BE 002 776-251	1134576	2PS 003 748-127	1208470	9EL 964 290-001
550015329	9EL 340 203-011	W270002108	2SE 002 776-211	1134577	9EL 147 910-001	1208471	9EL 964 290-001
550016158	9EL 183 432-001	W270002109	2SE 002 776-221	1134578	2PG 003 748-151	1208472	8RA 964 292-001
550016462	9DW 178 909-001	W270005213	1TA 003 570-101	1134579	9EL 148 274-001	1218057	8GD 002 078-248
550016463	9DW 178 909-011	W270005746	2PF 003 057-041	1134580	2PS 003 748-161	1218057	8GD 002 078-248
550016464	9DW 178 909-021			1134581	2PS 003 748-167	1218068	2VP 340 400-141
550016465	9DW 178 904-001			1134582	2SD 003 184-041	1218068	2VP 340 400-147
5800123	2SE 001 685-221			1134583	2SD 006 040-131	1218069	2VP 340 400-157
5800123/0	2SE 001 685-227			1134584	2SD 006 040-137	1224237	2VP 008 204-121
5800123/0	2SE 001 685-221			1134585	2SD 006 040-141	1224580	2VD 008 204-131
5800809/0	9GP 003 995-801			1134586	2SD 006 040-147	1226190	1GD 005 700-501
5801411	2KA 001 378-001			1134587	2KA 001 386-281	1228398	2PC 964 959-027
5801411/0	2KA 001 378-001			1134588	2TJ 001 633-211	1228398	2PC 964 959-027
5801434	2SL 003 567-311			1134589	9EL 132 404-001	1230865	8HG 006 294-041
5801434/0	2SL 003 567-311			1134590	2PF 001 648-161	1232012	1FA 007 133-021
5802071	2SD 001 685-211			1134591	2PF 001 259-631	1234812	1GA 006 991-081
5802071/0	2SD 001 685-218			1134592	2TF 001 259-761	1238945	2TA 964 169-061
5802071/0	2SD 001 685-218			1134593	2XS 005 020-011	1238945	2TA 964 169-067
5802072/0	2KA 001 386-281			1134594	2XS 005 020-017	1239164	2SA 001 259-751
5803616/0	2PS 004 361-001			1134595	2XS 005 020-021	1239164	2SA 001 259-757
5803616/0	2PS 004 361-007			1134596	2XS 005 020-091	1239165	2BA 001 259-618
5803625/0	2PF 001 259-631			1134597	2BA 001 259-618	1241124	2BA 001 259-618
5803642/0	2SE 001 685-201			1134598	2BA 001 259-611	1241124	1GA 007 506-021
5804155/0	1G4 003 470-031			1134599	2SA 001 259-751	1245081	2KA 997 011-001
5805106/1	2RL 008 060-111			1134600	2SA 001 259-757	1245081	2DA 343 106-011
5805461/0	2KA 003 389-001			1134601	2ZR 003 236-051	1246657	2DA 343 106-017
5806987/0	1GA 005 060-001			1134602	2ZR 003 236-057	1246657	2SD 003 182-067
5806987/0	1GB 006 213-111			1134603	9EL 119 544-111	1246657	2SD 003 182-067
5806987/0	1GB 006 213-117			1134604	1NE 006 300-011	1246658	2SE 003 182-011
5806987/1	1GB 996 102-101			1134605	1NE 138 555-011	1246658	2SE 003 182-011
5807524/0	2PF 001 259-677			1134606	2NE 003 236-001	1246660	9EL 118 614-011
5808491/0	2SK 005 883-011			1134607	2NE 003 236-008	1246661	9EL 118 613-001
5808492/0	2SK 005 883-021			1134608	9EL 119 544-001	1246674	2VP 340 400-131
5808673/0	2PS 006 717-031			1134609	9EL 854 912-001	1246675	2VP 340 400-121
5808673/0	2PS 006 717-037			1134610	2RL 008 060-111	1248127	8HG 160 409-002
5809357/0	8RA 003 326-001			1134611	2XS 950 071-031	1249169	2ZR 003 030-171
5809357/0	8RA 003 326-002			1134612	9EL 950 315-031	1251703	2RL 007 551-011
5809598/0	1NE 006 300-051			1134613	9EL 950 315-061	1251883	9EL 132 215-011
5809608/0	2PG 003 057-011			1134614	2XS 955 031-001	1252698	2SA 964 169-091
5809949	2JA 001 330-001			1134615	2XS 950 071-031	1252698	2SA 964 169-097
5809949	2JA 001 330-007			1134616	2PF 003 389-037	1252702	2SW 964 169-081
5810252/0	2PG 004 361-011			1134617	2PF 003 389-041	1252702	2SW 964 169-087
5810252/0	2PG 004 361-017			1134618	2XS 955 260-001	1252703	2ZR 964 169-031
5810617/0	8HG 006 294-021			1134619	2XS 955 260-007	1252703	2ZR 964 169-037
5810631/0	2PS 962 964-012			1134620	8JB 001 943-001	1253313	9EL 147 747-001
5810631/0	2PS 962 964-018			1134621	8JA 001 930-001	1253313	9EL 147 747-007
5810631/0	9GD 963 281-001			1134622	2BM 006 692-011	1253954	2BA 003 734-001
5811455/0	2SA 006 717-001			1134623	2BM 006 692-017	1255869	2SE 003 167-041
5811455/0	2SA 006 717-007			1134624	2BM 006 692-021	1260479	2PF 340 825-001
5811907/0	2PG 003 748-151			1134625	2BM 006 692-027	1260480	9XX 340 879-001
5811908/0	2PS 003 748-121			1134626	9GT 074 132-001	1261257	2ZR 005 860-151
5811908/0	2PS 003 748-127			1134627	9GT 005 166-001	1261445	2PS 008 645-001
5811909/0	2PS 003 748-161			1134628	8HG 002 240-001	1261445	2PS 008 645-007
5811909/0	2PS 003 748-167			1134629	8HG 002 240-031	1263622	2NE 964 169-341
5811910/0	2KA 003 389-211			1134630	8HG 002 365-001	1263623	2ZR 964 169-361
5811910/0	2KA 003 389-217			1134631	8HG 006 294-021	1263624	5DS 009 552-011
5814052/0	2XS 008 078-001			1134632	6ED 708 919-001	1263625	2BA 980 607-201
5814052/0	2XS 008 078-007			1134633	8GA 002 073-121	1263626	2SB 980 606-201
5814082/0	1GA 006 876-001			1134634	8GA 002 073-123	1264424	2ZR 006 609-081
5814098/0	2VP 007 907-031			1134635	8GA 002 073-241	1264424	2ZR 006 609-087
5814098/0	2VP 007 907-037			1134636	8GA 002 073-248	1265303	2SD 959 050-401
5814099/0	2VP 007 907-041			1134637	8GA 002 071-121	1265304	2KA 340 118-001
5814099/0	2VP 007 907-047			1134638	8GA 002 071-123	1265541	8RA 004 412-011
5814248/0	2PS 008 382-001			1134639	8GA 002 071-241	1275257	2VP 340 931-011
5814248/0	2PS 008 382-007			1134640	8GA 002 071-248	1275258	2VP 340 931-001
5814415/0	2PG 008 434-001			1134641	8GD 002 078-121	1275810	2SD 001 686-101
5815081/0	1ND 005 700-061			1134642	8GA 002 071-131	1276686	2RL 008 060-101
5815338/0	2VP 340 400-151			1134643	8GA 002 071-133	1281258	9GH 993 984-001
5815339/0	2VP 340 400-157			1134644	8GA 002 071-251	1282719	2RL 008 966-021
5815339/0	2VP 340 400-141			1134645	8GA 002 071-258	1284930	2ZR 959 820-601
5815339/0	2VP 340 400-147			1134646	8GP 002 067-121	1284931	2NE 959 821-201
5815436/0	1GA 007 506-001			1134647	8GP 002 067-123	1285176	2ZR 997 506-391
5815436/0	1GA 007 506-002			1134648	8GP 002 067-241	1286418	2VP 340 950-031
5815436/0	1GA 007 506-007			1134649	8GP 003 594-251	1286419	2VP 340 950-041
5816277/0	9GD 157 876-007			1134650	8GP 003 594-258	1300920	2RL 010 979-011
5816704/0	8RA 003 326-011			1134651	8GP 003 594-121	27001-300200	2SE 001 685-221
5816704/0	8RA 003 326-017			1134652	8GP 003 594-241	27001-300200	2SE 001 685-227
5819070/0	2VP 340 931-111			1134653	8GP 003 594-141	27001-310501	2SD 001 699-511
5819071/0	2VP 340 931-101			1134654	8GP 002 068-121	27001-310801	2SD 003 184-041
5819086/0	2PS 008 645-311			1134655	8GP 002 068-241	27001-310801	2SD 003 184-031
5819087/0	2PG 008 645-331			1134656	8GP 002 066-121	27001-310802	2SD 003 184-031
5821789/0	2KA 959 640-661			1134657	8GP 002 066-241	27001-310802	2VD 003 184-031
5870268/0	9EL 340 208-001			1134658	8GP 002 066-121	27001-410301	2SD 003 184-031
6000000/0	9EL 340 208-001			1134659	8GP 002 095-121	27001-410301	2VP 004 887-021
6200891/0	9EL 131 420-011			1134660	8GP 002 095-241	27001-510391	2VA 004 887-031
6200892/0	9EL 131 420-001			1134661	2ZR 003 315-041	27001-510391	2VP 007 907-041
6200894/0	9EL 119 544-001			1134662	8JA 003 526-001	27001-510391	2VP 007 907-047
731097008	9GD 157 876-007			1134663	8GA 002 073-251	27001-510392	2VP 007 907-031
745007074	2JA 010 838-017			1134664	8GA 002 071-261	27001-510392	2VP 007 907-037
745017054	2PG 008 645-971			1134665	8GP 002 067-261	27003-920002	2KA 003 389-061
745017063	2TM 008 645-951			1134666	8GA 002 071-271	27003-920002	2KA 003 389-062
745017063	2TM 008 645-957			1134667			



Manufacturer's no. / HELLA no. Cross-Reference

Langendorf	HELLA	Leart	HELLA	Liebherr	HELLA	Liebherr	HELLA
B17-0061	9EL 117 334-001	38.111.000	2VD 008 204-191	1 029 721 4	1GA 996 161-581	1 164 473 6	2TM 008 645-951
B17-0068	2PF 001 648-161	38.440.000	2SK 003 567-321	1 029 727 8	2RL 007 017-061	1 164 473 6	2TM 008 645-957
B17-0073-1	2XS 005 020-011	38.441.000	2SL 003 567-311	1 029 727 9	8HG 005 436-011	1 164 473 7	1EA 996 127-051
B17-0073-2	2XS 005 020-011	38.443.000	2SK 003 567-331	1 030 071 4	1GA 007 506-651	1 164 488 8	4DM 009 492-001
B17-0073-2	2XS 005 020-021	38.534.000	2VP 008 204-081	1 030 136 4	8GA 006 841-121	1 164 670 8	1GO 996 176-011
B17-0073-3	2XS 005 020-091	38.536.000	2VP 008 204-081	1 030 136 4	8GA 006 841-123	1 169 349 4	8GA 002 071-241
B17-0088	2ZR 003 236-051	38.537.000	2VD 008 204-091	1 030 311 5	2BA 344 169-027	1 169 448 6	8RA 009 362-001
B17-0088	2ZR 003 236-057	39.002.000	2KA 001 389-101	1 033 046 1	1GA 998 534-541	1 169 448 7	2ZR 009 001-117
B17-0089	9EL 119 544-111	39.026.000	2KA 003 389-061	1 033 079 0	9GD 102 484-001	1 182 605 2	2KA 010 278-011
B17-0098	2NE 003 236-001	39.026.000	2KA 003 389-062	1 033 080 7	2VP 006 040-397	1 182 884 9	9MN 860 677-021
B17-0098	2NE 003 236-008	39.026.000	2KA 003 389-068	1 033 080 8	2VP 006 040-407	1 259 651	2PS 003 057-051
B17-0099	9EL 119 544-001	39.400.000	2KA 001 386-231	1 033 150 4	8GS 009 028-111	1 259 651	2PS 003 057-057
B17-0138	8JA 001 930-001	42.032.000	2BE 003 014-251	1 033 571 9	2JA 007 372-051	10665278	8RA 009 001-031
B17-0190	8HG 002 240-001	42.032.000	2BE 003 014-257	1 035 161 4	8JA 004 667-001	10665278	8RA 009 001-037
B17-0940	8KW 701 235-033	74.700.000	2NE 005 603-071	1 035 633 7	1GA 007 506-091	10814903	9HD 155 239-001
B17-0991	8GP 003 594-251	74.700.000	2NE 005 603-077	1 041 154 8	8HG 003 799-001	11 213 549	8KB 900 299-241
B17-0991	8GP 003 594-258			1 041 233 9	2RL 007 017-071	11340947	2SD 997 131-367
B17-0992	8GP 003 594-121			1 042 447 1	8HG 006 294-131	11341458	1KU 247 043-021
B17-0993	8GP 003 594-241			1 042 490 4	2ZR 003 315-041	11341458	1KU 247 043-027
B17-1915	8GM 002 091-181			1 045 091 4	2ZR 005 700-191	2 100 800	1GA 996 188-001
B17-1925	8GM 002 091-131			1 045 494 5	1GA 997 506-217	2 100 801	1GA 007 506-391
B17-1930	8GM 002 091-251			1 045 494 6	1GA 997 506-227	2 100 801	1GA 007 506-431
B17-1956	8GH 002 089-133			1 048 993 8	2SD 343 390-401	2 100 801	1GA 007 506-491
B17-1956	8GH 002 089-136			1 053 076 7	2SD 343 390-407	2 100 801	1GA 996 083-011
				1 053 076 7	2NE 344 200-091	2 100 801	1GA 996 142-311
				1 053 076 7	2NE 344 200-097	2 100 801	1GA 998 522-011
				1 053 107 5	2XD 010 311-001	2 100 801	1GA 998 534-011
				1 054 126 2	2ZR 344 200-051	2 100 801	1GA 998 534-271
				1 054 126 2	2ZR 344 200-057	2 100 803	1GA 006 876-001
				1 054 126 3	2SD 344 100-101	2 100 803	1GA 007 506-431
				1 054 327 7	9EL 174 995-001	2 100 803	1GA 996 188-001
				1 065 176 2	1AS 003 178-231	2 100 803	1GA 996 189-001
				1 065 180 4	6ED 004 778-011	2 100 845	1GA 998 534-011
				1 065 183 6	8HG 990 368-001	3 730 300	1GA 007 506-391
				1 065 183 6	8HG 990 368-007	3 730 300	1GA 007 506-491
				1 065 200 10	1GA 998 534-011	3 730 300	1GA 996 189-001
				1 066 496 5	1GM 996 136-192	3 730 300	1GA 998 534-011
				1 066 527 7	2BA 009 001-511	3 730 300	1GA 998 534-271
				1 066 527 7	8XU 009 362-101	3 730 301	1GA 007 506-491
				1 066 527 9	2SB 009 362-011	3 730 301	1GA 996 189-001
				1 071 126 0	2BA 001 416-021	3 730 301	1GA 996 192-001
				1 071 424 6	2BE 010 102-011	4 015 987 09013	9XR 854 840-001
				1 080 003 3	2BA 009 001-107	4 050 650	2AB 004 532-031
				1 080 051 9	1BL 247 042-011	4 530 00	9EL 146 491-001
				1 080 051 9	1BL 247 042-017	4 530 470	2DA 001 240-341
				1 080 052 0	2BE 010 102-011	5 701 898 08	9EL 122 772-001
				1 080 207 7	9XD 161 119-017	5 701 899 08	9EL 122 772-051
				1 081 376 7	1GA 996 188-001	5 704 507 08	9EL 856 416-001
				1 081 424 4	1AL 009 998-041	5 704 507 77	9EL 856 416-001
				1 081 424 6	2BE 010 102-011	5 706 012 08	9EL 857 801-001
				1 081 540 5	9AH 254 228-012	5 710 680 08	9MN 858 616-011
				1 081 540 5	9AH 254 228-017	5 710 680 77	9MN 858 616-011
				1 081 540 6	9AH 165 968-001	5 711 167 08	9EL 119 544-001
				1 081 543 4	9XS 124 218-027	5 712 524 08	8GH 002 073-151
				1 081 563 5	9NS 152 922-007	5 714 139 77	9XR 854 840-001
				1 081 585 3	8JD 156 151-807	5 714 381 08	9EL 950 315-031
				1 081 585 3	1N0 010 294-011	5 714 381 77	9EL 950 315-031
				1 081 585 4	2TA 344 169-077	5 714 382 77	9EL 950 315-001
				1 081 585 6	2TA 344 169-087	5 716 571 08	9EL 859 020-001
				1 081 585 7	2NE 344 169-067	5 717 426 08	9EL 146 838-001
				1 081 586 3	2BN 344 169-097	5 799 507 08	9EL 859 020-101
				1 081 586 4	2BN 344 169-107	5 799 676 08	9EL 859 020-101
				1 081 590 5	2NE 344 169-117	5 998 600	1GA 007 506-391
				1 081 678 7	2KA 003 389-211	5 998 600	1GA 007 506-491
				1 081 678 7	2KA 003 389-217	5 998 600	1GA 996 142-311
				1 087 179 9	1GA 996 661-001	5 998 600	1GA 996 188-001
				1 087 215 1	2XS 011 744-051	5 998 610	1GA 996 189-001
				1 095 20	2XS 011 744-061	5 998 610	1GA 996 142-311
				1 095 20	9EL 104 571-031	5 998 610	1GA 996 188-001
				1 095 31	9EL 104 571-041	5 999 400	1GA 007 506-391
				1 100 153 8	9EL 118 613-001	5 999 400	1GA 007 506-491
				1 100 722 0	1TA 003 570-101	5 999 400	1GA 996 189-001
				1 100 725 3	9EL 950 315-061	6 000 069	8GP 002 068-241
				1 100 870 7	2JA 007 373-161	6 000 071	8GM 002 092-241
				1 100 899 4	1GA 007 506-681	6 000 072	8GA 002 083-251
				1 106 027 7	2JA 006 447-251	6 000 103	1S3 001 117-041
				1 106 027 9	1GA 996 189-001	6 000 116	2RL 006 846-011
				1 106 591 9	2XS 005 020-041	6 000 117	8GM 002 091-131
				1 106 591 9	2XS 005 020-047	6 000 118	2SB 003 018-031
				1 106 592 0	2SA 008 405-011	6 000 167	8GM 002 091-251
				1 106 592 0	2SA 008 405-017	6 000 308	8GA 002 071-251
				1 108 875 8	2XA 008 221-021	6 000 312	1G8 002 340-001
				1 110 079 9	2XA 008 221-027	6 000 316	8KW 701 235-033
				1 111 079 9	2TM 003 748-011	6 000 322	2JA 003 231-001
				1 111 734 1	2RL 010 979-011	6 000 332	1H3 002 456-012
				1 111 734 1	1GA 996 189-011	6 000 419	2JA 001 330-031
				1 111 734 2	2VP 343 640-041	6 000 731	2ZR 003 014-091
				1 111 734 2	2VP 343 640-051	6 000 766	2XW 007 146-001
				1 112 305 5	1GA 996 192-001	6 000 776	1G4 003 470-051
				1 112 393 9	2ZR 344 169-167	6 000 780	2XS 005 020-011
				1 112 393 9	2ZR 344 169-157	6 000 804	2XS 005 020-017
				1 112 394 0	2SD 344 169-147	6 000 804	1GA 006 060-001
				1 112 394 30	2SD 344 169-137	6 000 804	1GA 998 522-011
				1 112 394 31	2ZR 344 169-167	6 000 830	1AA 004 109-031
				1 112 394 39	2ZR 344 169-157	6 000 864	8GJ 002 525-136
				1 118 179 3	2SD 344 169-147	6 000 864	8GH 002 089-136
				1 118 2332	2TM 004 361-021	6 000 865	8GH 002 089-133
				1 118 257 3	8GJ 168 119-241	6 000 866	8GD 002 078-121
				1 118 273 2	1GA 996 192-061	6 000 867	8GP 002 095-121
				1 121 090 7	1GA 996 192-061	6 000 907	8RL 002 009-021
				1 129 3915	2PF 959 590-207	6 000 914	8GJ 002 525-281
				1 130 404 3	9XD 161 119-007	6 001 131	2XS 005 020-001
				1 130 428 4	2RL 007 900-261	6 001 131	2XS 005 020-002
				1 134 134 2	1GD 996 193-011	6 001 131	2XS 005 020-003
				1 134 192 9	1GA 996 188-021	6 001 131 08	2XS 005 020-001
				1 148 566 6	1GA 996 188-021	6 001 131 08	2XS 005 020-002
				1 148 566 6	8HG 006 294-141	6 001 151	2BE 003 182-091
				1 149 055 3	1GO 996 276-481	6 001 153	2BE 003 182-101
				1 149 243 5	1GO 996 276-487	6 001 191	8JA 007 158-001
				1 149 467 6	2JA 343 570-041	6 001 191	1AA 004 109-041
				1 162 121 2	9DX 862 849-001	6 001 202	1G3 005 760-001
				1 162 121 2	1GA 996 288-012	6 001 202	1G3 005 760-201
				1 162 264 7</			

Manufacturer's no. / HELLA no.

Cross-Reference



Liebherr	HELLA	Liebherr	HELLA	Liebherr	HELLA	Liebherr	HELLA
6 001 421 O	1AB 006 213-011	6 070 222 08	8GP 002 095-241	6 071 251 08	1FE 006 300-001	6 071 476 14	2KA 003 389-068
6 001 421 X	1AB 006 213-011	6 070 228 08	8GD 002 078-241	6 071 252 01	2XS 950 071-031	6 071 478 08	2PF 961 167-021
6 001 424	2BA 003 014-111	6 070 231 77	8GA 002 074-241	6 071 257 14	2KA 003 389-001	6 071 483 14	2AB 004 532-051
6 001 424	2BA 996 012-061	6 070 232 08	8GA 002 071-251	6 071 263 01	8RA 002 023-021	6 071 483 14	2AB 004 532-051
6 001 499	2BE 003 014-251	6 070 232 14	8GA 002 071-251	6 071 266 01	8RA 003 326-011	6 071 484 08	2BE 004 119-021
6 001 499	2BE 003 014-257	6 070 234	8GJ 002 525-251	6 071 266 01	8RA 003 326-017	6 071 484 14	2JA 007 372-011
6 001 539	2NE 001 423-011	6 070 234 08	8NE 002 525-251	6 071 267 08	2SA 003 014-051	6 071 485 08	1KL 007 834-027
6 001 546	1GB 006 213-101	6 070 234 14	8GJ 002 525-251	6 071 269 08	2PS 003 057-051	6 071 486 08	1NL 007 834-017
6 001 546	1GB 006 213-107	6 070 237	8GH 002 089-251	6 071 269 08	2PS 003 057-057	6 071 487 08	1BL 007 834-007
6 001 670	2SB 003 014-151	6 070 237 08	8GH 002 089-253	6 071 269 14	2PS 003 057-057	6 071 488 08	2DA 003 236-031
6 001 722	8HG 006 294-051	6 070 237 14	8GH 002 089-251	6 071 279 01	2PS 003 057-057	6 071 488 08	2DA 003 236-037
6 001 963	8JB 004 777-001	6 070 237 14	8GH 002 089-253	6 071 282 01	2XS 950 071-031	6 071 491 08	1GA 998 522-011
6 001 963	8JB 004 777-002	6 070 237 14	8GH 002 089-251	6 071 282 01	2KA 001 386-231	6 071 492 08	1EA 993 975-051
6 002 161	8JA 001 909-001	6 070 240 14	8GH 002 089-253	6 071 283 01	2KA 001 386-281	6 071 492 08	1EA 993 975-057
6 002 519	2ZR 002 985-261	6 070 240 14	8GH 002 089-133	6 071 292	2BM 002 652-031	6 071 493 08	1EA 993 975-061
6 003 035	2SA 003 057-021	6 070 240 14	8GH 002 089-136	6 071 292 08	2BM 002 652-031	6 071 493 08	1EA 993 975-067
6 003 073	8JB 004 777-001	6 070 247 01	8GA 002 071-251	6 071 293	2ZR 003 236-051	6 071 493 14	8GA 002 093-251
6 003 073	8JB 004 777-002	6 070 248 01	8GD 002 078-241	6 071 293	2ZR 003 236-057	6 071 494 08	2BM 006 692-011
6 003 252	9EL 120 240-011	6 070 300 08	8GS 002 296-111	6 071 293 08	2SA 003 236-041	6 071 494 08	2BM 006 692-017
6 003 311	8JA 001 915-001	6 070 336 14	8GP 002 067-261	6 071 295 08	2SA 003 236-048	6 071 495 08	2BM 006 692-021
6 004 180	8JA 001 925-001	6 071 000	2BA 001 227-201	6 071 296 08	2SA 003 236-041	6 071 495 08	2BM 006 692-027
6 004 186	1AB 007 145-001	6 071 003	2BA 001 248-001	6 071 296 08	2SA 003 236-048	6 071 496 08	2BM 003 355-001
6 004 186	1AB 007 145-007	6 071 010 08	2AA 001 200-131	6 071 297 08	2SA 001 259-751	6 071 496 08	2BM 008 355-007
6 004 187	2BA 003 014-111	6 071 011 08	2AA 001 200-141	6 071 297 08	2SA 001 259-757	6 071 497 08	2TM 003 057-031
6 004 350	8RA 004 412-021	6 071 040	2XM 004 444-011	6 071 298 08	2TM 003 057-031	6 071 499 08	2BE 964 169-071
6 004 402	8GA 002 073-251	6 071 040 08	2XM 004 444-011	6 071 300	2JA 001 330-001	6 071 499 08	2BE 964 169-077
6 004 447	2BA 964 169-311	6 071 043	2PF 001 648-161	6 071 300 08	2JA 001 330-007	6 071 500 08	1GA 007 506-111
6 004 448	2ZR 964 169-031	6 071 043 08	2PF 001 648-161	6 071 300 08	2JA 001 330-007	6 071 503 08	1GA 006 991-021
6 004 448	2ZR 964 169-037	6 071 043 77	2PF 001 648-161	6 071 305 08	1GB 002 340-001	6 071 505 08	2VD 007 323-141
6 004 449	2SB 964 169-301	6 071 058 08	2SD 001 688-141	6 071 306 08	2ZR 001 193-011	6 071 506 08	2VD 007 323-131
6 004 449	2SB 964 169-307	6 071 059	2BA 001 259-611	6 071 307	2PF 003 014-071	6 071 507 08	2VP 007 323-121
6 004 450	2BE 964 169-071	6 071 059	2BA 001 259-618	6 071 307	2SD 001 685-231	6 071 508 08	1GA 007 506-081
6 004 451	2BE 964 169-077	6 071 059 08	2BA 001 259-611	6 071 314 08	2SD 001 685-232	6 071 509 08	1GA 007 506-081
6 004 451	2XS 950 071-031	6 071 059 08	2BA 001 259-618	6 071 316	2XS 005 020-021	6 071 511 08	1GA 007 506-121
6 004 452	2PS 008 392-811	6 071 060 8	2XW 003 146-001	6 071 316 0	2XS 005 020-021	6 071 512 08	1GA 996 142-141
6 004 452	2PS 008 392-817	6 071 062 08	2XW 003 146-001	6 071 316 08	2XS 005 020-021	6 071 513 08	1GA 996 142-151
6 004 453	2NE 964 169-021	6 071 062 08	2SD 001 685-211	6 071 318 08	1G3 996 001-001	6 071 578 14	2SA 961 167-011
6 004 453	2NE 964 169-027	6 071 065 01	2SD 001 685-211	6 071 318 08	2AB 004 532-051	6 071 580 14	1GB 996 080-001
6 021 170 08	9XD 130 261-001	6 071 065 01	2SE 001 685-218	6 071 325 14	2AB 004 532-057	6 071 600 01	2SL 003 567-311
6 022 040 08	8KW 701 235-033	6 071 066 01	2SE 001 685-201	6 071 325 14	2AB 004 532-051	6 071 605 01	2SA 006 717-001
6 023 345 08	9GT 963 129-001	6 071 066 08	2SE 001 687-031	6 071 334 08	2SD 001 679-001	6 071 605 01	2SA 006 717-007
6 027 09	1GA 998 522-011	6 071 069	8RA 003 503-001	6 071 335	2PS 004 361-001	6 071 610 01	2XS 955 260-001
6 027 385 01	9GT 963 129-001	6 071 069 08	2SD 003 167-021	6 071 335	2PS 004 361-007	6 071 610 01	2XS 955 260-007
6 050 029 08	8JA 001 925-001	6 071 070	2SD 003 167-011	6 071 335 01	2PS 962 964-012	6 071 4401	2AA 001 200-031
6 050 034	8JA 001 909-011	6 071 070 08	2SD 003 167-011	6 071 335 01	2PS 962 964-018	6 072 009 14	8HG 002 240-021
6 050 034 08	8JA 001 909-011	6 071 076	2KA 003 168-021	6 071 335 01	2PS 962 964-031	6 072 010 08	8HG 002 240-001
6 050 049 08	8JA 002 263-031	6 071 076 08	2KA 003 168-021	6 071 335 01	2PS 962 964-037	6 072 011	8HG 002 240-031
6 050 056 08	8JA 001 930-001	6 071 078	2KA 003 389-061	6 071 335 08	2PS 004 361-001	6 072 011 08	8HG 002 240-031
6 050 056 14	8JA 001 930-011	6 071 078	2KA 003 389-062	6 071 335 08	2PS 004 361-007	6 072 012 08	8HG 002 365-001
6 050 059	8JA 001 909-011	6 071 078 0	2KA 003 389-062	6 071 340 08	2SA 003 057-021	6 072 012 08	8HG 006 294-101
6 050 059 14	8JA 001 909-011	6 071 078 0	2KA 003 389-061	6 071 341 08	2PF 003 057-001	6 072 012 14	8HG 002 365-001
6 050 083	8JA 001 925-001	6 071 078 08	2KA 003 389-068	6 071 343 08	2BA 001 221-041	6 072 017 08	9EL 854 912-001
6 050 083 14	8JA 001 925-001	6 071 078 08	2KA 003 389-061	6 071 344 08	2BA 001 221-041	6 072 022	9EL 074 484-011
6 052 030 08	8JB 001 933-031	6 071 078 08	2KA 003 389-062	6 071 349 08	2PF 001 647-031	6 072 023	9ES 015 675-001
6 052 039 08	8JB 004 777-001	6 071 078 08	2KA 003 389-068	6 071 349 08	2PF 001 647-037	6 072 038	9EL 110 736-001
6 052 039 08	8JB 004 777-002	6 071 079 08	2AB 004 532-051	6 071 349 77	2PF 001 647-031	6 072 039	9EL 110 737-001
6 056 239 01	8KW 701 235-033	6 071 079 08	2AB 004 532-057	6 071 349 77	2PF 001 647-037	6 072 055 14	9XS 027 639-001
6 070 013	8GA 002 073-121	6 071 080	2PF 001 648-161	6 071 351 08	2XS 005 020-011	6 072 076	8HG 002 365-001
6 070 013	8GA 002 073-123	6 071 087	8RA 003 326-001	6 071 351 08	2XS 005 020-017	6 072 105 08	9EL 108 435-001
6 070 033 08	8GP 003 594-251	6 071 087	8RA 003 326-002	6 071 362 08	2JA 001 357-002	6 072 105 08	9EL 147 747-001
6 070 045	8GD 002 084-131	6 071 087 08	8RA 003 326-001	6 071 367 08	1G5 003 241-021	6 072 107 01	9EL 147 747-007
6 070 046	8GP 002 066-121	6 071 087 08	8RA 003 326-002	6 071 367 08	2SD 003 182-051	6 072 111 08	8HG 002 240-021
6 070 047	8GM 002 091-121	6 071 088 08	8RA 003 326-001	6 071 367 08	2SD 003 182-057	6 072 111 08	9EL 852 061-001
6 070 062 05	2AA 001 200-141	6 071 088 08	8RA 003 326-002	6 071 368 08	2SD 003 182-061	6 072 120 08	9GD 087 883-355
6 070 091 08	8GA 002 083-251	6 071 093 08	8RA 003 326-017	6 071 368 08	2SD 003 182-067	6 072 127 08	1GB 132 233-011
6 070 094 77	8GA 002 071-261	6 071 097 08	2AA 001 200-041	6 071 374	2XS 950 071-031	6 072 135 01	8HG 006 294-011
6 070 095 77	8GA 002 073-251	6 071 104 08	2NE 001 423-011	6 071 374 08	2XS 950 071-031	6 072 138 008	9EL 119 544-111
6 070 097 08	8GP 002 095-241	6 071 111	2PF 001 529-631	6 071 374 77	2XS 950 071-031	6 072 138 08	9EL 119 544-111
6 070 106 01	8GM 002 091-251	6 071 111 08	2JA 001 330-031	6 071 381 01	2PS 006 717-031	6 072 164 08	9GH 096 532-001
6 070 106 08	8GM 002 094-241	6 071 111 77	2JA 001 330-031	6 071 381 01	2PS 006 717-037	6 072 216 08	9GD 120 670-001
6 070 107 01	8GM 002 091-241	6 071 113 08	2AA 001 200-031	6 071 383 01	2SB 003 014-151	6 072 260 08	9EL 110 013-001
6 070 107 08	8GM 002 091-241	6 071 121	2JA 003 232-011	6 071 384	8RA 004 412-011	6 072 261 08	9EL 110 014-001
6 070 111 01	8GA 002 073-121	6 071 122	2ZR 003 236-051	6 071 384 01	2PG 006 717-021	6 072 262 08	9EL 146 887-001
6 070 111 01	8GA 002 073-123	6 071 122	2ZR 003 236-057	6 071 387 01	2PG 006 717-027	6 072 262 08	9EL 146 887-001
6 070 111 08	8GP 002 096-061	6 071 122 08	2ZR 003 236-051	6 071 387 01	2ZR 003 014-091	6 072 268 08	8HG 006 294-051
6 070 113 01	8GJ 002 525-131	6 071 122 08	2ZR 003 236-057	6 071 388 01	2SD 002 582-017	6 072 274 08	8HG 006 294-091
6 070 113 01	8GJ 002 525-136	6 071 123 08	2BA 002 324-011	6 071 388 08	1G4 003 470-031	6 072 275 08	9GH 145 943-001
6 070 115 08	8GP 003 594-241	6 071 123 14	2BA 002 324-021	6 071 389 01	2SD 002 582-011	6 072 276 08	9GT 143 133-001
6 070 130 01	8GA 002 071-241	6 071 124	2BA 002 324-021	6 071 389 01	2SD 002 582-017	6 072 277 08	9GH 993 988-007
6 070 131 01	8GA 002 073-241	6 071 124 08	2BA 002 324-021	6 071 389 01	2SD 002 582-027	6 072 300 14	9EL 856 416-011
6 070 134 01	8GM 002 092-241	6 071 125 08	2BA 002 324-021	6 071 389 08	2SD 002 582-027	6 140 018 08	6ZE 001 759-051
6 070 140	8GP 002 068-121	6 071 125 08	2BA 001 416-011	6 071 390 08	2RL 006 846-011	6 200 012	8GP 002 067-241
6 070 141	8GP 002 067-121	6 071 127	2BA 002 324-001	6 071 397 01	1AE 004 234-001	6 200 566	8GP 002 066-241
6 070 141	8GP 002 067-123	6 071 127 08	2BA 002 324-001				



Manufacturer's no. / HELLA no.

Cross-Reference

Liebherr	HELLA	Liebherr	HELLA	Linde	HELLA	Linde	HELLA
6 905 033	2BA 002 652-121	7 002 596	9AG 104 328-001	000 974 06 02	2VA 006 040-071	791 956 49 21	8GA 002 071-133
6 905 033	2BA 002 652-127	7 002 627	9EL 112 741-001	000 974 06 02	2VA 006 040-077	791 956 49 21	8GA 002 071-251
6 905 121	8GJ 002 525-281	7 002 628	9EL 112 743-001	000 974 06 06	2VB 001 301-021	791 956 49 27	8GA 002 071-251
6 905 206	8RA 003 326-011	7 003 761	2JA 001 330-001	000 974 07 00	2KA 001 389-101	791 956 49 43	8GH 002 089-251
6 905 206	8RA 003 326-017	7 003 761	2JA 001 330-007	000 974 07 04	2KA 998 523-001	791 956 49 43	8GH 002 089-253
6 905 207	8RA 003 326-001	7 004 086	9FF 900 500-001	000 974 07 04	2KA 998 523-007	791 956 49 45	8GH 002 090-133
6 905 207	8RA 003 326-002	7 009 390	1AA 126 924-035	000 974 10 00	2BA 002 652-101	791 956 49 45	8GH 002 090-136
6 905 282	1EA 007 108-011	7 014 383	9EL 118 614-021	000 974 10 00	2BA 002 652-107	791 956 49 46	8GH 002 090-251
6 905 282	1EA 007 108-017	7 014 433	2JA 001 357-002	000 974 10 01	2BA 003 022-021	791 956 49 46	8GH 002 090-253
6 905 283	1EA 007 108-021	7 016 076	1G3 135 211-011	000 974 10 05	2BA 001 227-201	791 956 49 52	8GP 002 068-241
6 905 283	1EA 007 108-027	7 018 158	8HG 006 294-021	000 974 10 09	2BA 001 227-201	791 956 49 55	8GH 002 090-271
6 905 284	2KA 998 523-001	7 021 344	9GH 096 532-001	000 974 10 20	2BE 001 259-061	791 956 49 58	8GP 002 067-241
6 905 284	2KA 998 523-007	7 026 567	2SD 998 531-067	000 974 10 21	2BA 001 248-001	791 956 49 66	8GP 002 066-241
6 905 324	8GA 002 073-121	7 026 568	2SD 998 531-057	000 974 10 22	2BA 002 652-111	791 956 49 70	8GM 002 091-251
6 905 324	8GA 002 073-123	7 026 604	1GA 998 534-011	000 974 10 22	2BA 002 652-117	791 956 49 78	8GM 002 091-241
6 905 325	8GA 002 071-131	7 026 612	1EA 993 975-101	000 974 10 23	2BA 002 652-127	791 956 49 82	8GM 002 092-241
6 905 325	8GA 002 071-133	7 026 612	1EA 993 975-107	000 974 10 23	2BA 002 652-127	791 956 49 85	8GA 006 841-121
6 905 351	2RL 006 846-001	7 026 613	1EA 993 975-091	000 974 10 27	2BE 003 014-251	791 956 49 85	8GD 002 078-121
6 905 359	2RL 006 846-001	7 026 613	1EA 993 975-097	000 974 10 27	2BE 003 014-257	791 956 49 85	8GD 002 078-121
6 905 359	2RL 006 846-011	7 026 908	8GS 007 949-261	000 974 10 28	2BA 003 014-111	791 956 49 92	8GD 002 078-241
6 905 463	1AB 004 231-001	7 029 805	5DV 990 264-011	000 974 10 29	2SE 002 578-701	791 956 49 97	8GA 002 073-241
6 905 508	2SA 997 027-001	7 029 805	1GA 007 506-391	000 974 11 02	2SE 002 578-707	791 965 10 10	2AB 004 532-011
6 905 621	2BE 003 014-251	7 209 013	1GM 996 134-091	000 974 11 02	2SA 001 259-751	791 965 10 12	2JA 343 720-021
6 905 621	2BE 003 014-257	7 365 734	9KS 075 307-001	000 974 11 02	2SA 001 259-757	791 968 00 07	2TM 964 295-091
6 905 653	8GD 002 078-241	7 365 734	2SD 001 699-061	000 974 11 03	2PF 001 259-631	791 968 00 07	2TM 964 295-097
6 905 676	1GB 996 080-021	7 367 680	9EL 109 139-001	000 974 11 04	2TJ 001 633-211	95353204	1GA 007 506-001
6 905 738	1GA 006 991-041	7 372 932	9EL 856 416-001	000 974 11 06	2PF 008 405-051	95353204	1GA 007 506-002
6 905 739	1GB 996 080-011	7 403 320	9EL 859 020-001	000 974 11 06	2PF 008 405-057	95353204	1GA 007 506-007
6 905 828	2JA 006 447-041	7 406 908	2NE 996 012-021	000 974 15 00	2AA 001 200-021	95353285	1GA 007 506-391
6 905 839	2JA 006 447-041	7 408 151	9EL 854 912-001	000 974 15 01	2AA 001 200-023	95353285	1GA 007 506-011
6 905 854	2VP 006 040-397	7 412 253	8JA 001 921-102	000 974 15 02	2AA 001 200-031	974 042 7	1GS 996 001-391
6 905 855	2VP 006 040-407	7 412 253	1GA 007 506-011	000 974 15 02	2AA 001 200-011	9740460	1GM 996 134-071
6 905 900	8GH 007 157-241	7 412 253 03	1GA 007 506-012	000 974 15 02	2AA 001 200-012	9740462	1GM 996 134-071
6 908 028 08	2XS 005 020-011	7 412 253 03	1GA 007 506-011	000 974 17 00	2AA 001 201-011	9740467	1GM 996 134-081
6 908 028 08	2XS 005 020-017	7 615 832	8HG 002 240-021	000 974 60 00	2XW 003 146-001	9740471	1GN 996 361-461
6 930 298 14	1NE 001 423-011	7 617 452	9EL 856 416-001	000 974 60 20	9EL 132 403-001	FM8 112 58 7	1GA 005 060-001
6 931 487 14	1E3 996 160-681	7 620 344	9EL 113 639-021	000 974 60 24	9EL 856 010-001	FM8 112 64 0	1GA 003 470-001
6 931 487 14	1E3 996 160-671	7 622 572	8RA 003 326-031	000 974 60 27	9EL 113 639-021		1GA 003 470-031
6 931 489 14	2SD 001 685-231	7 622 573	8RA 003 326-041	000 974 60 29	9EL 998 002-031		
6 931 489 14	2SD 001 685-232	7 622 573	8RA 003 326-047	000 974 60 31	9EL 088 525-001		
6 931 650 14	9GH 993 984-001	7 623 693	2XW 007 146-001	000 974 60 34	9EL 110 540-001		
6 931 939 14	9EL 128 922-011	7 623 802	1AA 143 897-011	000 974 60 35	9EL 115 003-011		
6000774	1G3 996 001-131	7 623 848	9EL 136 825-001	000 974 60 36	9EL 118 614-011		
607002808	8GM 002 091-251	7 623 849	9EL 136 825-011	000 974 60 37	9EL 115 003-055		
6071343	2BA 001 221-031	7 623 851	8HG 006 294-111	000 974 60 38	9EL 110 536-011		
6071344	2BA 001 221-041	8 125 6	1GA 998 522-011	000 974 60 39	9EL 146 491-001		
607134608	2SK 003 567-321	9 200 919	2SD 002 582-011	000 974 60 40	9EL 137 307-001		
607134708	2SK 003 567-331	9 200 919	2SD 002 582-017	000 974 60 41	9EL 137 308-001		
6071349	2PF 001 647-031	9 605 207	8RA 003 326-001	000 974 60 42	9EL 964 536-001		
6071349	2PF 001 647-037	9 605 207	8RA 003 326-002	000 974 79 05	9FF 090 500-001		
6071351	2XS 005 020-011	9 732 200	1GA 007 506-391	000 974 81 01	9ES 015 675-001		
6071351	2XS 005 020-017	9 732 200	1GA 007 506-431	000 974 82 01	9DR 090 206-001		
6071361	2JA 001 357-002	9 732 200	1GA 996 188-001	000 974 82 02	9DS 121 707-001		
6071362	1G5 003 241-021	9 732 200	1GA 996 189-001	000 974 82 03	9DR 066 847-001		
607139108	2XS 005 020-001	9 732 200	1GA 998 522-011	000 974 82 12	1G3 135 211-011		
607139108	2XS 005 020-002	9 732 200		000 974 83 03	9GD 023 639-001		
607139108	2XS 005 020-003	9 732 200		000 974 83 05	9GD 024 183-001		
607139208	1G3 005 760-011	000 964 03 37	9GH 993 984-001	000 974 84 15	9GD 120 670-001		
607139301	2SK 003 567-331	000 964 03 38	9GH 993 988-007	000 974 83 05	9KS 075 307-001		
607139401	2SK 003 567-321	000 973 07 01	6ED 708 919-001	000 994 01 02	8RA 004 412-021		
607139408	2XS 005 020-121	000 973 90 03	8XS 113 389-001	000 994 01 03	8RA 003 326-031		
607139601	2SD 006 040-031	000 974 00 00	2JA 001 364-001	000 994 01 13	8RA 003 326-002		
607139601	2SD 006 040-037	000 974 00 04	2JA 004 531-011	000 994 01 13	8RA 003 326-002		
607139708	2DA 003 014-031	000 974 00 06	2JA 006 447-041	0009746001	9EL 132 404-001		
607139708	2DA 003 014-037	000 974 00 11	2JA 007 373-197	001 975 18 00	8JA 003 526-001		
607139801	2SD 006 040-161	000 974 02 01	2DA 003 014-031	002 974 00 03	2JA 001 357-002		
607139801	2SD 006 040-167	000 974 02 01	2DA 003 014-037	002 974 10 00	2BE 001 259-061		
607140408	2PF 003 389-037	000 974 02 05	2NE 002 985-001	002 974 17 04	8GM 002 094-121		
607140908	2XS 003 168-071	000 974 02 09	2SB 001 259-261	002 974 17 05	8GM 002 094-241		
607141708	2SA 006 679-027	000 974 02 12	2SW 003 014-131	002 974 17 06	8GM 002 091-241		
607141908	1G9 001 523-021	000 974 02 12	2SD 003 182-061	002 974 60 06	9EL 126 294-001		
607142008	2ZR 003 014-091	000 974 02 13	2SD 003 182-067	002 974 79 00	9FF 111 606-021		
6071477	2TJ 001 633-211	000 974 02 13	2SD 003 182-051	0029741702	8GA 002 073-121		
607147714	2TJ 001 633-211	000 974 02 13	2SD 003 182-057	0029741702	8GA 002 073-123		
6071478	2PF 003 057-001	000 974 02 16	2SD 002 776-231	0029741702	8GM 002 091-181		
607148214	1AB 004 231-001	000 974 02 16	2SD 002 776-237	036 651 95 66	2BA 003 014-011		
6071483	2AB 004 532-051	000 974 02 17	2SD 002 776-241	036 651 98 45	2SA 003 014-051		
6071483	2AB 004 532-057	000 974 02 17	2SD 002 776-247	036 652 02 88	2ZR 003 014-091		
6071489	2BA 003 014-111	000 974 02 17	2SE 998 530-061	036 652 39 26	2ST 003 014-141		
6071493	8GA 002 083-251	000 974 02 21	2SE 998 530-067	036 652 39 46	2SB 003 014-151		
607149414	8GS 002 296-111	000 974 02 30	2SD 964 169-111	037 752 60 77	2SE 004 623-001		
6071495	8GH 002 473-151	000 974 02 30	1S0 001 430-111	037 752 60 77	2SE 004 623-007		
607200908	8HG 002 240-021	000 974 04 00	1G3 005 760-011	127 363 19 15	9EL 088 150-001		
6072010	8HG 002 240-001	000 974 04 02	1GA 005 060-337	146 351 14 03	9EL 136 819-031		
607203508	9EL 092 435-011	000 974 04 02	1A3 005 760-518	320 363 39 00	8GS 002 296-111		
607203814	9EL 110 736-001	000 974 04 07	1G3 005 760-011	576 204 80 01	8HG 002 365-001		
607206408	9EL 112 744-001	000 974 04 08	1GA 005 060-001	576 204 80 02	2SD 001 680-271		
6072078	9DR 060 567-001	000 974 04 12	1GA 998 52				

Manufacturer's no. / HELLA no.

Cross-Reference



MAN	HELLA	MAN	HELLA	MAN	HELLA	MAN	HELLA
28.22526.060201	2XS 955 031-001	81.25108.0015	1G3 135 211-011	81.25229.6053	9EL 134 658-001	84.25215.0005	8RA 002 023-011
33.25225.6001	2BM 008 355-001	81.25108.0020	1GA 998 525-001	81.25229.66128	9EL 122 772-051	84.25215.0006	8RA 002 020-001
33.25225.6002	2BM 008 355-007	81.25110.6005	9EL 101 353-001	81.25229.66133	9EL 122 689-021	84.25215.0006	8RA 002 020-002
33.25225-6002	2PS 003 057-051	81.25113.0030	1G8 132 233-011	81.25229-0962	9EL 862 141-001	84.25225.6015	2SD 001 240-311
33.25225-6002	2PS 003 057-057	81.25113.0044	9DE 132 750-015	81.25230-0031	9EL 208 551-011	84.25225.6017	2DA 003 236-311
33.25231.0001	9GT 137 236-007	81.25113.6011	9DF 112 246-001	81.25231.0030	9GD 120 670-001	84.25225.6017	2DA 003 236-037
36.24102-6008	1NO 008 582-037	81.25113.6016	1NE 138 555-011	81.25231.0041	9GD 087 883-355	84.25225.6018	2SA 003 236-041
36.25101.6000	1KO 008 191-041	81.25113.0050	1EA 990 185-021	81.25236.0023	9FF 126 444-001	84.25225.6018	2SA 003 236-048
36.25101.6000	1KO 008 191-047	81.25120.0014	9GH 152 654-007	81.25236.0047	9FF 135 906-021	84.25225.6028	2BA 003 236-321
36.25101.6001	1BL 008 193-011	81.25140.0097	9XD 130 261-001	81.25238.6009	9MN 858 616-011	84.25225.6061	2KA 004 525-001
36.25101.6001	1BL 008 193-017	81.25201.6075	2JA 003 232-011	81.25250.7003	2SA 001 240-331	84.25229-0078	9EL 119 544-031
36.25101-6002	1BL 007 834-007	81.25201.6086	2JA 003 231-011	81.25260.6001	2PF 001 648-171	84.66804-6005	2XM 004 444-011
36.25101-6003	1KL 007 834-027	81.25201.6132	2JA 001 357-002	81.25260.6014	2XS 005 020-001	85.20001-1848	2SK 003 567-321
36.25101-6016	1AL 008 934-001	81.25201.6192	2JA 003 354-001	81.25260.6014	2XS 005 020-002	85.20001-1849	9GP 003 995-801
36.25102.6000	1NO 008 582-011	81.25201.7006	2AB 001 208-001	81.25260.6014	2XS 005 020-003	85.20001-2512	2SD 003 167-521
36.25102.6000	1NO 008 582-017	81.25203.6016	2ZR 006 609-081	81.25260.6015	2PF 001 647-031	85.25103.6001	1GA 006 876-001
36.25102.6000	1NO 010 294-001	81.25203.6016	2ZR 006 609-087	81.25260.6015	2PF 001 647-037	85.25103-6003	1H3 002 456-012
36.25102-6001	1NL 007 186-021	81.25205-6008	2JB 996 012-121	81.25260.6020	2SA 001 638-021	85.25103-6012	1G3 996 001-331
36.25102-6004	1NL 007 186-027	81.25207.6003	8HG 002 365-001	81.25260.6023	2SA 001 647-041	85.96001.0005	9GT 074 132-001
36.251026000	1NL 008 090-327	81.25207.6066	2RL 008 060-011	81.25260.6029	2TJ 001 633-211	88.25225.6004	2BA 001 416-011
36.25103.6000	1NO 008 582-037	81.25210.0014	2AA 001 200-011	81.25260.6047	2XS 005 020-011	88.25225.6005	2BA 001 416-021
36.25103.6000	2ZR 008 221-051	81.25210.0014	2AA 001 200-012	81.25260.6047	2XS 005 020-017	88.25225.6008	2BA 001 221-041
36.25103.6005	2ZR 008 221-057	81.25210.0015	2AA 001 200-021	81.25260.6056	2XS 950 071-031	88.25229.0004	9EL 110 014-001
36.25103.6005	2ZR 959 010-501	81.25210.0026	2AA 001 200-023	81.25260.6058	2PF 001 259-631	88.25101.6007	1KO 008 191-021
36.25103-6003	2ZR 959 010-507	81.25210.0027	2AA 001 200-041	81.25260.6062	2XS 005 020-041	88.25101.6007	1KO 008 191-027
36.25109-0000	2ZR 001 240-377	81.25210.0028	2AA 001 200-111	81.25260.6062	2XS 005 020-047	88.25101-6008	1NL 008 090-311
36.25140-0000	9HD 149 253-007	81.25210.0089	2AA 001 200-012	81.25260.7009	2PF 001 638-011	88.25101-6008	1NL 008 090-337
36.25201-6010	9XB 152 977-001	81.25225.6042	2SA 001 693-011	81.2531.0030	9GD 120 670-001	88.25120.0001	1NL 008 090-117
36.25201-6012	2JA 004 531-011	81.25225.6045	2SA 001 693-011	81.25320.6049	2BA 002 324-021	88.25120.0002	9GH 152 654-007
36.25201-6013	2JA 005 590-001	81.25225.6046	2SA 001 240-331	81.25320.6050	2BA 002 324-021	88.25120.0002	9GH 158 051-007
36.25201-6013	2JA 003 231-001	81.25225.6046	2DA 001 240-341	81.25320.6058	2BA 003 022-021	88.25201.6033	2JA 001 331-011
36.25202-6003	2AB 004 532-051	81.25225.6047	2BA 001 240-301	81.25320.6071	2BA 003 236-021	88.25201.6064	2PF 001 259-677
36.25202-6003	2AB 004 532-057	81.25225.6061	2BE 001 699-071	81.25320.6071	2BA 003 236-027	88.25210.6014	2PF 001 259-677
36.25209.0002	9XB 161 749-007	81.25225.6062	2SD 001 699-001	81.25320.6076	2BA 003 014-011	88.25215.0001	8RA 008 405-001
36.25225.6000	2XA 008 221-021	81.25225.6083	2BA 001 227-201	81.25321.0022	9EL 116 907-001	88.25215.0001	8RA 008 405-007
36.25225.6000	2XA 008 221-027	81.25225.6092	2SE 001 680-281	81.25321.0028	9EL 990 186-001	88.25222-0004	9EL 110 014-001
36.25225.6001	2NE 008 221-031	81.25225.6097	2SD 001 680-291	81.25325.7016	2BA 001 240-301	88.25225.6012	2BA 001 221-031
36.25225.6001	2NE 008 221-037	81.25225.6100	2KA 001 389-101	81.25407.6139	8KA 950 073-001	88.25225.6015	2KA 001 622-001
36.25225.6002	2DA 959 071-737	81.25225.6103	2SE 003 167-031	81.25432.0139	8JB 850 434-011	88.25225.6023	2BA 003 236-541
36.25225-002	2DA 959 071-737	81.25225.6107	2BM 002 847-011	81.25435.0007	8JA 001 909-011	88.25225.6026	2BA 008 221-001
36.25225-6006	2DA 005 603-031	81.25225.6109	2BM 002 847-021	81.25435.0040	8JA 001 915-001	88.25225.6026	2BA 008 221-007
36.25225-6006	2DA 005 603-037	81.25225.6109	2KA 001 622-001	81.25435.0084	8JA 001 909-001	88.25225.6031	2DA 008 805-011
36.25225-6007	2SA 005 603-021	81.25225.6111	2KA 001 378-041	81.25435.0088	8JA 001 914-011	88.25225.6031	2DA 008 805-017
36.25225-6007	2SA 005 603-027	81.25225.6119	2KA 001 389-101	81.25435.0888	8JA 003 526-001	88.25225.6033	2SB 008 805-021
36.25225-6008	2SD 003 184-031	81.25225.6141	2VP 003 567-111	81.25435-007	8JA 001 909-011	88.25225.6033	2SB 008 805-027
36.25225-6008	2SD 003 184-037	81.25225.6151	2SL 003 567-311	81.25505.0501	8ED 708 919-001	88.25225.6034	2KA 959 640-607
36.25225-6009	2SD 003 184-041	81.25225.6162	2SA 003 057-021	81.25501.0008	8GP 002 067-241	88.25229.0005	9EL 110 013-001
36.25225-6009	2SD 003 184-047	81.25225.6172	2SL 003 567-311	81.25501.0029	8GP 002 066-061	88.25260.6003	2SA 001 638-021
36.25225-6015	2PS 009 226-017	81.25225.6182	2KA 003 389-081	81.25501.0041	8GA 002 074-241	88.25260.6009	2XS 003 168-071
36.25240.6000	2KA 005 049-011	81.25225.6198	2VP 003 567-121	81.25501.0043	8GP 002 095-241	88.25260.6010	2SA 006 679-027
36.25240.6000	2KA 005 049-017	81.25225.6198	2VP 003 567-127	81.25501.0109	8GS 007 001-151	88.25260.6012	2PS 006 717-031
36.25260.6000	2PF 008 221-011	81.25225.6233	2KA 001 386-301	81.25501.0199	8GA 002 072-241	88.25260.6012	2PS 006 717-037
36.25260.6000	2PF 008 221-017	81.25225.6259	2SD 003 167-531	81.25501.0043	8HG 151 866-001	88.25260.6014	2XS 005 020-001
36.25260.6001	2SA 008 405-011	81.25225.6260	2SD 003 167-541	81.25501.0315	5DV 008 856-001	88.25260.6014	2XS 005 020-002
36.25260.6001	2SA 008 405-017	81.25225.6402	2SD 001 685-231	81.25501.0315	5DV 008 856-007	88.25260.6014	2XS 005 020-003
36.25260.6002	2PF 003 563-151	81.25225.6402	2SD 001 685-232	81.25501.0315	5DV 008 856-007	88.25260.6014	2BA 003 014-111
36.25260.6004	2XS 008 479-051	81.25225.6403	2SE 001 685-221	81.25501.0315	5DV 008 856-007	88.25260.6014	2BA 001 277-011
36.25260.6004	2XS 008 479-057	81.25225.6403	2SE 001 685-227	81.25501.0315	5DV 008 856-007	88.25260.6014	2BA 001 277-011
36.25260.6005	2XS 008 479-041	81.25225.6404	2TF 001 259-761	81.25501.0315	5DV 008 856-007	88.25260.6014	2BA 001 277-011
36.25260.6005	2XS 008 479-047	81.25225.6413	2NE 003 236-301	81.25501.0315	5DV 008 856-007	88.25260.6014	2BA 001 277-011
36.25260.6009	2PF 003 563-187	81.25225.6423	2ZR 001 240-351	81.25501.0315	5DV 008 856-007	88.25260.6014	2BA 001 277-011
36.25260-6010	2PF 006 679-007	81.25225.6424	2DA 001 240-341	81.25501.0315	5DV 008 856-007	88.25260.6014	2BA 001 277-011
36.25260-6012	2PF 965 039-151	81.25225.6425	2SA 001 240-331	81.25501.0315	5DV 008 856-007	88.25260.6014	2BA 001 277-011
36.25260-6013	2PS 964 295-001	81.25225.6426	2BA 001 240-301	81.25501.0315	5DV 008 856-007	88.25260.6014	2BA 001 277-011
36.25260-6013	2PS 964 295-007	81.25225.6438	2BA 002 652-101	81.25501.0315	5DV 008 856-007	88.25260.6014	2BA 001 277-011
36.25260-6027	2TM 345 600-311	81.25225.6438	2BA 002 652-107	81.25501.0315	5DV 008 856-007	88.25260.6014	2BA 001 277-011
36.25260-6027	2TM 345 600-317	81.25225.6449	2BA 005 603-001	81.25501.0315	5DV 008 856-007	88.25260.6014	2BA 001 277-011
36.25320.6000	2BA 008 221-001	81.25225.6449	2BA 005 603-007	81.25501.0315	5DV 008 856-007	88.25260.6014	2BA 001 277-011
36.25320.6000	2BA 008 221-007	81.25225.6451	2DA 003 734-011	81.25501.0315	5DV 008 856-007	88.25260.6014	2BA 001 277-011
36.25320.6001	2BA 008 221-041	81.25225.6459	2BM 006 692-011	81.25501.0315	5DV 008 856-007	88.25260.6014	2BA 001 277-011
36.25320.6002	2BA 008 221-047	81.25225.6459	2BM 006 692-017	81.25501.0315	5DV 008 856-007	88.25260.6014	2BA 001 277-011
36.25320.6006	2BM 008 355-001	81.25225.6481	2BM 006 692-021	81.25501.0315	5DV 008 856-007	88.25260.6014	2BA 001 277-011
36.25320.6002	2BM 008 355-007	81.25225.6482	2BM 006 692-027	81.25501.0315	5DV 008 856-007	88.25260.6014	2BA 001 277-011
36.25320.6006	2BM 008 355-017	81.25225.6482	2SB 003 014-151	81.25501.0315	5DV 008 856-007	88.25260.6014	2BA 001 277-011
36.25320-6004	2BE 004 119-021	81.25225.6482	2DA 003 014-037				



Manufacturer's no. / HELLA no.

Cross-Reference

MAN	HELLA	Massey Ferguson	HELLA	Mercedes-Benz	HELLA	Mercedes-Benz	HELLA
N1.01107-7023	2XA 959 790-401	4291408M92	1GA 007 506-007	000 820 04 57	2DA 959 071-737	001 540 26 70	2VD 007 500-201
N1.01107-7023	2XA 959 790-407	4291409M91	1GA 007 506-001	000 820 05 59	1BL 008 193-011	001 540 29 70	2VD 007 500-091
N1.01400-0293	9EL 091 749-011	4291409M91	1GA 007 506-002	000 820 08 64	1BL 008 193-017	001 540 57 70	2VD 007 500-411
N1.01401-4174	8JD 156 150-807	4291409M91	1GA 007 506-007	000 820 09 09	2SA 001 240-331	001 540 58 70	2VP 007 500-421
Maserati	HELLA	4291409M91	1GA 007 506-007	000 820 09 09	9BG 121 587-031	001 540 62 70	2VD 007 500-411
383100502	8GP 938 026-001	4295856M91	1GA 006 991-041	000 820 09 09	9BG 121 587-037	001 540 63 70	2VP 007 500-421
Massey Ferguson	HELLA	4392669	1GA 006 975-001	000 820 12 60	2KA 001 378-041	001 542 14 27	2AA 003 257-031
0 960 916 M91A	2KA 001 389-101	5 017 952 M1	2RL 007 337-001	000 820 12 64	2SA 001 240-331	001 544 00 01	1A3 002 850-001
1 161 20W9 1	1GB 006 213-101	6 857 84	9ES 015 675-001	000 820 14 64	2SA 001 638-021	001 544 04 03	2SE 001 699-071
1 161 20W9 1	1GB 006 213-107	9 690 18 M1	2PF 001 634-101	000 820 14 67	2ZR 001 240-351	001 544 05 03	2SD 001 699-511
1 628 494 M1	8GH 002 090-133	9 692 36 M1	2BE 001 278-011	000 820 15 67	2ZR 001 193-011	001 544 06 03	2SA 001 634-121
1 628 494 M1	8GH 002 090-136	D 450 513 00	8HG 002 365-001	000 820 17 68	2BA 001 240-301	001 544 06 92	8RA 003 326-011
1 639 404 M 1	2BA 001 227-211	Mazda	HELLA	000 820 19 60	2KA 001 389-101	001 544 06 92	8RA 003 326-017
1 639 404 M 1	2BA 001 227-211	1737-02-7	2JA 003 231-001	000 820 20 56	2NE 001 423-011	001 544 08 01	1A5 003 178-231
1 654 364 M1	6ED 004 778-001	Mekra	HELLA	000 820 22 67	2ZR 001 240-351	001 544 08 03	2SE 001 680-291
1 673 469 MO1A	2JA 001 330-001	20.6865.600	2BA 001 227-201	000 820 25 68	2SB 001 673-002	001 544 09 03	2SD 001 680-281
1 673 469 MO1A	2JA 001 330-007	20.6868.700	2SW 003 014-131	000 820 27 25	2DA 001 240-341	001 544 11 03	2SE 001 686-142
1 682 832 MO1A	8RA 003 326-001	20.6868.710	9EL 115 003-011	000 820 31 21	2BA 004 119-001	001 544 11 03	1AA 004 109-201
1 682 832 MO1A	8RA 003 326-002	20.6960.700	8RA 004 412-001	000 820 52 21	2SB 001 423-097	001 544 12 03	2SD 001 686-101
1 682 832 M1	8RA 003 326-002	20.6960.800	8RA 004 412-021	000 820 55 01	2BM 004 312-051	001 544 13 03	2SE 001 680-291
1 682 832 M1	8RA 003 326-002	Mercedes-Benz	HELLA	000 820 59 56	2BM 004 312-061	001 544 14 03	2SE 001 680-301
1 682 832 M1	1AB 003 177-611	000 000 00 01 72	8GH 007 643-121	000 820 61 21	2JA 001 364-001	001 544 14 03	2SD 001 680-281
1 682 832 M1	1AB 003 177-611	000 000 57 17	8JA 003 526-001	000 820 63 56	2NE 001 423-011	001 544 15 03	2SD 001 680-271
1 693 944 M92	9EL 004 137-001	000 000 65 69	2DA 003 236-331	000 820 71 10	2BM 002 652-051	001 544 19 03	2SE 001 688-161
1 693 944 M92A	1GB 006 213-111	000 000 65 85	2NE 003 236-301	000 820 72 56	2ZR 003 030-171	001 544 20 03	2SD 001 688-171
1 699 227 M3	1GB 006 213-117	000 000 65 86	2ZR 003 236-311	000 820 87 01	6ZE 001 759-051	001 544 21 94	8GH 002 473-132
116121W91	1G3 005 760-001	000 000 68 20	2PF 006 679-007	000 820 87 01	2NE 003 030-151	001 544 37 90	9EL 102 240-031
116121W91	2ZR 001 240-351	000 000 68 28	2PF 001 647-031	000 820 87 56	2JA 001 330-001	001 544 38 01	1AB 006 213-011
2 876 134 3	9GH 096 532-001	000 000 68 28	2PF 001 647-037	000 820 89 20	2JA 001 330-007	001 544 40 03	2SE 001 699-071
2 924 342 M91	9EL 118 700-001	000 000 68 85	2NE 003 236-301	000 820 90 56	2ZR 003 030-171	001 544 41 03	2SD 001 699-061
3 041 759 MO1A	9EL 118 701-001	000 000 68 86	2ZR 003 236-311	000 820 90 56	2BA 001 227-211	001 544 45 03	1AB 006 213-001
3 100 765 M1	2AA 001 200-041	000 000 68 86	2PT 010 102-111	000 820 93 56	2KA 003 389-061	001 544 46 03	2SD 001 699-061
3 100 766 M1	8RA 003 326-001	000 000 68 86	2PT 009 599-811	000 820 93 56	2KA 003 389-068	001 544 46 03	9EL 109 139-001
3 102 003 M1	8RA 003 326-002	000 543 10 42	2KA 001 589-141	000 820 93 56	2XS 005 020-001	001 544 63 03	2SD 001 685-218
3 102 003 M1	1GA 132 459-011	000 543 12 42	2KA 001 589-141	000 820 93 56	2XS 005 020-002	001 544 64 03	2SD 001 685-218
3 104 791 M1	1GA 005 060-001	000 544 00 34	2PF 003 057-001	000 820 94 56	2XS 005 020-003	001 544 64 03	2SE 001 685-201
3 105 630 M1	2BE 003 014-251	000 544 00 75	1H3 002 456-012	000 821 01 25	2TJ 001 633-211	001 544 68 03	2SD 003 167-011
3 141 070 M1	9EL 115 003-055	000 544 03 47	8JA 001 909-011	000 822 04 07	8JA 001 909-001	001 544 68 03	2SD 003 167-021
3 141 070 M1	9EL 116 844-001	000 544 04 86	1G8 002 340-001	000 822 04 08	2AA 001 200-151	001 544 68 90	9EL 092 435-011
3 144 691 M1	2SA 001 634-121	000 544 05 47	9EL 146 838-001	000 822 03 88	9EL 854 912-001	001 544 69 03	2SE 003 167-031
3 188 336 M1	1G4 003 470-331	000 544 06 12	1H3 002 456-032	000 822 31 97	9DX 859 625-001	001 544 75 03	2SD 001 680-281
3 219 86 M1	2SD 002 582-021	000 544 08 47	1GA 005 060-001	000 822 33 97	9DX 859 625-001	001 544 76 03	2SE 001 680-291
3 248 394 0	2SD 002 582-027	000 544 09 47	1GD 003 590-701	000 822 34 10	9DX 856 863-001	001 544 77 90	9EL 107 368-001
3 304 566 M91	2SD 002 582-011	000 544 11 04	2NE 003 236-001	000 822 35 88	9DX 856 862-001	001 544 79 90	9EL 111 647-001
3 304 567 M91	2SD 002 582-011	000 544 13 07	2NE 003 236-008	000 822 35 88	9DX 856 862-001	001 544 79 90	9EL 107 368-001
3 304 567 M91	2JA 001 357-002	000 544 17 04	1GA 998 522-011	000 822 43 10	9DX 856 862-001	001 544 82 03	9EL 111 647-001
3 385 820 M1	2JA 001 357-002	000 544 17 04	2NE 006 609-001	000 822 75 10	9EL 116 907-001	001 544 82 03	2SD 003 167-011
3 389 596 MO1A	8RA 004 412-021	000 544 17 04	2NE 006 609-007	000 822 76 10	9EL 052 476-001	001 544 82 03	2SD 003 167-011
3 389 596 M1	8RA 004 412-021	000 544 18 04	1AL 009 998-041	000 822 82 20	9EL 110 737-001	001 544 83 03	2SD 003 167-011
3 539 335 M92	4RA 933 791-061	000 544 24 07	2NE 003 236-301	000 822 82 10	9EL 110 736-001	001 544 83 03	9AG 104 328-001
3 708 059 M91	2BE 003 182-091	000 544 24 07	2ZR 003 236-051	000 822 98 10	2BA 003 022-037	001 544 83 90	2SE 003 167-041
3 713 135 M1	1GB 006 213-111	000 544 26 18	1G8 132 233-011	000 825 00 14	9EL 115 830-001	001 544 83 90	9EL 147 747-001
3 713 135 M1	1GB 006 213-117	000 544 27 18	1AB 003 177-071	000 825 02 03	9XB 136 202-005	001 544 83 90	9EL 147 747-001
3 713 341 M1	8GJ 002 525-131	000 544 27 93	9FF 090 500-001	000 825 06 03	2KA 001 389-101	001 544 91 44	8GA 006 841-121
3 713 341 M1	8GJ 002 525-136	000 544 28 34	2KA 001 386-281	000 825 06 03	2JA 001 357-002	001 544 91 44	8GA 006 841-123
3 786 64M 91	1GA 996 161-101	000 544 29 05	8RL 002 009-021	000 825 07 01	2PF 004 081-007	001 544 91 94	8GA 006 841-123
3 786 66M 91	1GA 996 161-291	000 544 30 34	2KA 001 386-231	000 825 08 01	2JA 001 357-002	001 544 92 90	8GA 006 841-121
3 786 68M 91	1GA 996 161-121	000 544 32 05	8RL 002 009-021	000 825 10 10	2JA 001 357-012	001 544 94 90	8GA 006 841-123
3 901 645 M1	2AA 001 201-011	000 544 32 18	1A3 996 162-321	000 825 30 10	9EL 116 607-005	001 545 04 26	9EL 119 544-111
3234458000	1G0 996 176-041	000 544 32 34	2KA 001 386-281	000 825 60 01	9EL 120 240-011	001 545 58 11	8JB 001 933-031
3387 863 M91	1GA 005 060-001	000 544 32 47	1FO 011 988-131	000 826 00 26	2PT 008 935-001	001 545 89 32	8JB 850 434-011
3617 494 M91	1GA 006 876-001	000 544 33 07	2ZR 003 236-311	000 826 04 47	8JB 850 434-011	001 581 00 09	2SE 001 680-301
3713 130 M91A	1GA 006 991-041	000 544 33 47	1FO 008 390-327	000 826 04 47	2PF 001 647-031	001 820 05 01	2PF 001 647-031
3713 132 M91A	1GB 996 080-001	000 544 34 47	1AL 009 997-041	000 826 05 56	2PF 001 647-037	001 820 05 01	2PF 001 647-037
3714 399 M92	1GA 006 876-001	000 544 34 91	9KS 075 307-001	000 826 05 56	9EL 950 315-001	001 820 10 58	9EL 950 315-001
3778 456 M92	1GA 006 991-041	000 544 35 47	1FO 012 206-011	000 826 09 97	9EL 950 315-031	001 820 11 01	9EL 950 315-031
3786 664 M91	1GA 996 161-101	000 544 37 34	2KA 003 168-021	000 826 10 40	9GD 100 140-001	001 820 14 56	9GD 100 140-001
3786 664 M91	1GA 996 161-351	000 544 37 90	9ES 015 675-001	000 826 10 44	8RA 003 660-007	001 820 15 21	8RA 003 660-007
3786 666 M91	1GA 996 161-291	000 544 39 11	2XS 007 841-011	000 826 14 41	2SD 001 693-011	001 820 34 35	2SD 001 693-011
3786 668 M91	1GA 996 161-121	000 544 39 11	2XS 007 841-021	000 826 14 41	9GD 024 183-001	001 820 37 21	9GD 024 183-001
3786 668 M91	1GA 996 361-501	000 544 40 11	8RA 002 016-111	000 826 14 41	8RA 003 326-021	001 820 38 21	8RA 003 326-021
3786668M93	1GA 996 361-501	000 544 41 05	8RA 003 326-001	000 826 16 40	2PS 002 727-001	001 820 38 21	2PS 002 727-001
3788 157 M91	1GB 996 147-101	000 544 42 05	8RA 003 326-002	000 826 17 41	2PS 004 361-007	001 820 39 21	2PS 004 361-007
3788 233 M91	1GA 996 161-121	000 544 43 90	9EL 141 612-001	000 826 16 40	8RA 003 326-041	001 820 39 21	8RA 003 326-041
3788699M93	2BA 001 248-001	000 544 44 05	2SB 001 673-002	000 826 17 41	8RA 003 326-011	001 820 40 21	8RA 003 326-011
4 199 21 M1	1GB 006 213-111	000 544 44 05	8RA 004 412-021	000 826 18 40	8RA 003 326-017	001 820 54 01	8RA 003 326-017
4 271 29M 91	1GA 996 161-121	000 544 45 05	8RA 002 0				

Manufacturer's no. / HELLA no.

Cross-Reference



Mercedes-Benz	HELLA	Mercedes-Benz	HELLA	Mercedes-Benz	HELLA	Mercedes-Benz	HELLA
002 544 07 03	0010	500 923 90 20	9EL 088 525-001	A 000 544 60 31	6NM 008 299-501	A 000 826 28 40	8RA 003 326-041
002 544 07 10		608 926 00 56	9EL 126 294-001	A 000 544 62 30	2BA 008 221-217	A 000 826 28 40	8RA 003 326-047
002 544 07 90		612 820 00 56	2KA 005 049-011	A 000 544 63 30	2BA 009 001-167	A 000 826 29 40	2PF 001 648-161
002 544 08 03		612 820 00 56	2KA 005 049-017	A 000 544 65 03	2ST 001 673-011	A 000 826 30 40	9EL 115 003-055
002 544 08 03	0010	612 820 01 20	2BM 008 355-001	A 000 544 65 92	9DR 060 567-001	A 000 826 30 17	2SA 001 259-571
002 544 08 03	10	612 820 01 20	2BM 008 355-007	A 000 544 65 92	9ZF 111 606-021	A 000 826 30 17	2SA 001 259-575
002 544 09 03		613 826 02 41	2PS 962 964-012	A 000 544 70 03	2SE 001 699-071	A 000 826 31 10	9EL 110 536-011
002 544 12 90		613 826 02 41	2PS 962 964-018	A 000 544 76 03	2SD 001 686-101	A 000 826 34 82	9FF 085 642-001
002 544 13 03		613 826 02 41	2PS 962 964-031	A 000 544 76 92	9DR 104 336-001	A 000 826 35 10	9EL 137 241-001
002 544 14 03		613 826 02 41	2PS 962 964-037	A 000 544 77 03	2SD 001 699-061	A 000 826 42 47	2PF 001 259-631
002 544 15 03		632 820 10 01	2PT 008 935-801	A 000 544 77 80	9GD 102 484-001	A 000 826 43 47	2BA 001 259-611
002 544 16 90		662 820 01 58	2RL 008 181-111	A 000 544 78 03	2SE 001 699-071	A 000 826 43 47	2BA 001 259-618
002 544 19 90		663 820 00 47	1GA 996 388-011	A 000 544 78 06	1NL 008 090-117	A 000 826 50 10	9EL 859 020-001
002 544 20 90		663 820 00 93	2RL 007 900-601	A 000 544 79 80	9GD 102 484-001	A 000 827 07 31	9GH 152 654-007
002 544 21 90		663 820 04 14	9XD 861 990-001	A 000 544 85 80	9GD 087 883-355	A 000 827 08 03	9GH 158 051-007
002 544 26 03		666 820 03 56	2PF 003 563-151	A 000 544 87 80	9GD 120 670-001	A 000 906 98 01	2JA 007 373-187
002 544 31 94		667 546 01 37	9FF 141 941-001	A 000 544 93 03	2SE 002 582-071	A 000 988 01 15	9XD 198 241-002
002 544 32 94		671 820 04 56	2KA 006 896-001	A 000 544 99 03	2SD 001 699-061	A 000 993 00 98	9XR 855 975-001
002 544 33 94		671 820 04 56	2KA 006 896-007	A 000 544 66 131	6NM 007 282-231	A 000 997 32 86	9GH 096 532-001
002 544 34 94		673 820 00 21	2BA 002 652-101	A 000 545 13 47	1GA 998 522-011	A 000 997 80 81	9GT 074 132-001
002 544 40 03		673 820 00 21	2BA 002 652-107	A 000 545 21 15	2AA 001 200-011	A 000 997 80 91	9GT 074 132-001
002 544 42 03		699 544 01 10	2XS 950 071-031	A 000 545 21 15	2AA 001 200-011	A 000 997 95 81	9GT 067 751-001
002 544 47 90		699 544 03 03	2SK 003 567-331	A 000 580 01 97	2XIM 004 444-001	A 000 998 57 05	9GT 137 236-007
002 544 54 03		699 544 04 03	2SK 003 567-321	A 000 583 09 53	2XW 003 146-001	A 000 202481V002L044	8GP 003 594-121
002 544 55 03		700 485 00 40	2BA 002 324-001	A 000 583 29 53	2XW 002 897-041	A 001 540 13 70	2VD 007 500-091
002 544 57 03		711 185 01 30	2SD 001 686-101	A 000 585 11 03	8XH 002 975-017	A 001 540 16 70	2VD 007 500-201
002 544 58 03		711 185 56 30	9EL 852 061-001	A 000 626 18 40	8RA 003 326-031	A 001 540 17 70	2VD 007 500-111
002 544 62 90		716 185 50 50	2KA 001 610-001	A 000 657 01 23	8HG 096 531-007	A 001 540 20 70	2VD 007 500-221
002 544 63 90		716 285 02 30	2SK 003 567-331	A 000 820 00 50	2JA 003 354-001	A 001 540 22 70	2VD 007 500-221
002 544 91 03		716 285 02 40	2SK 003 567-321	A 000 820 00 52	2AB 001 208-001	A 001 540 25 70	2VD 007 500-111
002 544 97 03		755 601 20 02 0	2AB 004 532-051	A 000 820 04 57	2DA 959 071-737	A 001 540 26 70	2VD 007 500-201
002 544 98 03		755 601 20 02 0	2AB 004 532-057	A 000 820 05 59	1BL 008 193-011	A 001 540 29 70	2VD 007 500-091
002 820 34 56		758 185 00 30	2BA 002 652-101	A 000 820 08 59	1BL 008 193-017	A 001 540 57 70	2VD 007 500-411
002 820 34 56		758 185 00 30	2BA 002 652-107	A 000 820 08 64	2SA 001 240-331	A 001 540 58 70	2VP 007 500-421
002 820 47 56		86 1019 4054-90	2SD 001 679-001	A 000 820 09 09	9BG 121 587-037	A 001 540 62 70	2VD 007 500-411
002 820 57 56		86 1041 0603-90	2SB 003 018-031	A 000 820 09 09	9BG 121 587-037	A 001 540 63 70	2VP 007 500-421
002 820 90 56		901 820 02 56	2NE 003 315-011	A 000 820 12 60	2KA 001 378-041	A 001 542 14 27	2AA 003 257-031
002 820 90 56		901 820 02 56 X	2NE 003 315-011	A 000 820 12 64	2SA 001 240-331	A 001 544 00 01	1A3 002 850-001
002 822 17 10		904 820 03 56	2ZR 003 315-041	A 000 820 14 64	2SA 001 638-021	A 001 544 04 03	2SE 001 699-071
002 826 20 78		904 820 03 56	2ZR 003 315-041	A 000 820 14 67	2ZR 001 240-351	A 001 544 05 03	2SD 001 699-511
002 826 20 78		939 723 10 93 01	2XS 950 071-031	A 000 820 15 67	2ZR 001 193-011	A 001 544 06 03	2SA 001 634-121
002 826 72 90		949 820 00 39	1K0 247 043-031	A 000 820 17 68	2BA 001 240-301	A 001 544 06 92	8RA 003 326-011
003 540 22 70		949 820 00 39	1K0 247 043-037	A 000 820 19 60	2KA 001 389-101	A 001 544 06 92	8RA 003 326-017
003 544 56 03		956 543 00 42	2XD 012 160-851	A 000 820 20 56	2NE 001 423-011	A 001 544 08 92	1A5 003 178-231
003 544 57 03		956 820 00 39	1BL 247 042-011	A 000 820 22 67	2ZR 001 240-351	A 001 544 08 03	2SE 001 680-291
003 820 13 56		956 820 00 39	1BL 247 042-017	A 000 820 24 68	2SB 001 673-002	A 001 544 09 03	2SD 001 680-281
003 820 13 56		956 820 02 39	1K0 247 043-021	A 000 820 25 68	2DA 001 240-341	A 001 544 10 03	2SE 001 686-142
003 820 13 56		956 820 02 39	1K0 247 043-027	A 000 820 26 68	2BA 004 119-001	A 001 544 11 01	1AA 004 109-201
003 820 14 56		956 825 00 02	2XD 011 557-101	A 000 820 28 68	2SB 001 423-007	A 001 544 11 03	2SD 001 686-101
003 820 26 56		957 540 04 40	8HG 153 152-001	A 000 820 37 21	2BM 004 312-051	A 001 544 12 03	2SE 001 680-291
003 820 26 56		957 820 00 01	2JA 006 447-041	A 000 820 41 64	2BM 004 312-061	A 001 544 13 03	2SE 001 680-301
003 820 26 56		957 820 02 61	2JD 007 872-077	A 000 820 55 01	2JA 001 364-001	A 001 544 14 03	2SD 001 680-281
003 820 27 56		957 820 03 61	1DL 007 872-087	A 000 820 59 56	2NE 001 423-011	A 001 544 15 03	2SD 001 680-271
003 820 27 56		975 540 04 40	8HG 153 152-001	A 000 820 61 21	2BM 002 652-051	A 001 544 19 03	2SE 001 688-161
003 820 59 56		A 000 000 00 01 72	8GH 007 643-121	A 000 820 63 56	2ZR 003 030-171	A 001 544 20 03	2SD 001 688-171
003 820 60 56		A 000 000 57 17	8JA 003 526-001	A 000 820 71 10	6ZE 001 759-051	A 001 544 21 94	8GH 002 473-132
004 545 32 26		A 000 000 65 69	2DA 003 236-331	A 000 820 72 56	2NE 003 030-151	A 001 544 37 90	9EL 102 240-031
004 820 00 42		A 000 000 65 85	2NE 003 236-301	A 000 820 87 01	2JA 001 330-001	A 001 544 38 01	1AB 006 213-011
004 820 01 42		A 000 000 65 86	2ZR 003 236-311	A 000 820 87 01	2JA 001 330-007	A 001 544 40 03	2SE 001 699-071
004 821 08 51		A 000 000 68 28	2PF 006 679-007	A 000 820 87 56	2ZR 003 030-171	A 001 544 41 03	2SD 001 699-061
005 545 21 14		A 000 000 68 28	2PF 001 647-031	A 000 820 89 20	2BA 001 227-211	A 001 544 45 03	2SE 001 699-071
005 546 59 37		A 000 000 68 86	2PF 001 647-037	A 000 820 90 56	2KA 003 389-061	A 001 544 46 01	1AB 006 213-001
007 997 13 92		A 000 000 68 86	2NE 003 236-301	A 000 820 90 56	2KA 003 389-062	A 001 544 46 03	2SD 001 699-061
012 545 64 28		A 000 000 68 86	2ZR 003 236-311	A 000 820 90 56	2KA 003 389-068	A 001 544 55 90	9EL 109 139-001
083 820 03 61		A 000 543 10 42	2PT 010 102-111	A 000 820 93 56	2XS 005 020-001	A 001 544 63 03	2SD 001 685-211
083 820 04 61		A 000 543 12 42	2PT 009 599-811	A 000 820 93 56	2XS 005 020-002	A 001 544 63 03	2SD 001 685-218
100 820 00 01		A 000 543 13 42	2PT 009 599-141	A 000 820 94 56	2XS 005 020-003	A 001 544 64 03	2SE 001 685-201
140 000 18 33		A 000 544 00 34	2KA 001 386-231	A 000 820 94 56	2TJ 001 633-211	A 001 544 68 03	2SD 003 167-011
140 000 18 34		A 000 544 00 75	9EL 134 301-011	A 000 821 01 25	8JA 001 909-001	A 001 544 68 03	2SD 003 167-021
140 000 32 62		A 000 544 01 29	2PF 003 057-001	A 000 822 04 07	2AA 001 200-151	A 001 544 68 90	9EL 092 435-011
140 000 32 62		A 000 544 03 47	1H3 002 456-012	A 000 822 04 90	9EL 854 912-001	A 001 544 69 03	2SE 003 167-031
140 000 32 63		A 000 544 04 86	8JA 001 909-011	A 000 822 30 88	9DX 859 560-001	A 001 544 69 03	2SE 003 167-041
140 000 32 63		A 000 544 05 47	1G8 002 340-001	A 000 822 33 97	9DX 859 625-001	A 001 544 75 03	2SD 001 680-281
140 000 34 20		A 000 544 06 12	9EL 146 838-001	A 000 822 35 88	9GD 856 562-001	A 001 544 76 03	2SE 001 680-291
140 000 60 00		A 000 544 08 47	1H3 002 456-032	A 000 822 35 88	9GD 856 863-001	A 001 544 77 90	9EL 107 368-001
140 000 60 02		A 000 544 09 47	1GA 005 060-001	A 000 822 43 10	9DX 859 626-001	A 001 544 78 90	9EL 111 647-001
140 000 60 02		A 000 544 11 04	1GD 003 590-701	A 000 822 74 10	9EL 116 907-001	A 001 544 80 03	2SE 003 167-031
140 000 60 03		A 000 544 11 04	2NE 003 236-001	A 000 822 75 10	9EL 052 476-001	A 001 544 81 03	2SD 003 167-021
140 000 60 03		A 000 544 13 47	1GA 998 522-008	A 000 822 76 10	9EL 110 737-001	A 001 544 82 03	2SD 003 167-011
209 820 07 56		A 000 544 17 04	2NE 006 609-001	A 000 822 82 20	9EL 110 736-001	A 001 544 83 03	9AG 104 328-001
209 820 07 56		A 000 544 17 04	2NE 006 609-007				



Manufacturer's no. / HELLA no.

Cross-Reference

Mercedes-Benz	HELLA	Mercedes-Benz	HELLA	Merit, Malta	HELLA	Monark-Diesel	HELLA
A 001 822 00 10	9EL 852 820-001	A 350 009 00 04	9EL 856 010-001	113200	8JA 004 667-001	91 824 032	8GM 002 091-241
A 001 822 12 10	9EL 113 639-021	A 350 090 90 03	2AA 001 204-001	113202	8JA 004 667-001	98 241 120	2XS 950 071-031
A 001 822 21 10	9EL 855 097-001	A 350 090 90 04	2AA 001 204-011	113301	8JA 001 921-102		HELLA
A 001 822 24 20	9EL 852 061-001	A 350 090 90 10	2ST 003 018-061	738000	2AA 001 200-001		8RA 002 016-111
A 001 822 25 20	2BA 001 240-301	A 350 090 90 18	2SD 001 679-001	738100	2AA 001 200-041		8JA 001 909-011
A 001 822 28 20	2BA 001 240-301	A 350 090 90 19	2SB 001 259-261	738200	2AA 001 200-031		052.495.1
A 001 822 34 20	2BA 002 324-011	A 350 923 90 15	9EL 088 150-001	738300	2AA 001 200-151		2KA 003 389-068
A 001 822 35 20	2BA 002 324-021	A 350 923 90 20	9EL 088 525-001	738400	2AA 001 200-021		2BA 002 652-121
A 001 822 48 20	2BM 002 847-011	A 373 820 07 56	2SA 961 167-011	738500	2AA 001 200-141		055.231.4
A 001 822 49 20	2BM 002 847-021	A 373 820 17 64	2SA 003 236-041	738600	2AA 001 200-011		2BA 002 652-127
A 001 822 50 20	2BM 002 847-021	A 373 820 17 64	2SA 003 236-048	738700	2AA 001 200-131		055.231.5
A 001 822 51 20	2BM 002 847-011	A 373 820 18 64	2DA 003 236-031	743500	2KA 001 389-101		2BA 002 652-117
A 001 822 65 10	9EL 856 418-001	A 373 820 18 64	2DA 003 236-037				093.317.9
A 001 822 66 10	9EL 856 417-001	A 400 453 86 08	2BA 001 227-201	Messmer	HELLA		1A5 003 178-411
A 001 822 66 20	2BA 001 227-211	A 400 809 00 00 07	8GH 007 157-121	221 063	6EG 001 567-041		2XW 003 146-001
A 001 822 72 20	2BA 002 652-117	A 400 809 00 00 07	8GH 007 157-126	451 174	2AA 003 257-001		114.833.4
A 001 822 73 20	2BA 002 652-121	A 405 540 00 54	1AL 009 997-041	451 175	2AA 003 257-011		098.725.3
A 001 822 73 20	2BA 002 652-127	A 405 544 01 01	1DL 007 872-017	451 176	2AA 003 257-021		119.033.9
A 001 822 78 10	9EL 856 415-001	A 405 544 02 01	1DL 007 872-027	451 177	2AA 003 257-031		157.031.8
A 001 822 79 10	9EL 856 416-001	A 425 820 01 01	1GA 007 506-681	451 315	2AA 003 257-041		157.042.5
A 001 822 80 20	2BA 003 014-011	A 461 822 00 97	9GD 860 936-001				171.016.7
A 001 822 81 20	2BA 003 014-111	A 463 800 01 52	8JB 001 933-031	Mitsubishi	HELLA		171.017.6
A 001 826 47 90	9EL 101 353-001	A 463 820 00 56	1F5 008 273-041	DO-001-007	8JA 001 909-001		171.017.8
A 001 826 77 90	9EL 108 435-001	A 463 820 04 56	2AA 001 200-011	MB958902	8GM 002 091-131		171.022.0
A 002 544 00 94	8GH 007 157-121	A 500 076 70 01	2AA 001 200-012	MR910391	8GP 003 594-121		171.022.1
A 002 544 00 94	8GH 007 157-126	A 500 076 70 01	2ST 003 018-061	S119021	8GM 002 092-121		171.026.5
A 002 544 02 03	2SE 003 167-001	A 500 090 90 10	2SD 001 679-001	S345133	8GA 006 841-121		171.026.6
A 002 544 06 90	9EL 131 420-031	A 500 090 90 19	2SB 001 259-261	S345133	8GA 006 841-123		171.105.2
A 002 544 07 03	2VB 004 887-011	A 500 923 90 15	9EL 088 525-001	SMB958902	8GM 002 091-131		171.203.8
A 002 544 07 03	2VB 004 887-011	A 500 923 90 20	9EL 088 525-001	SMME31640S6	1K0 008 191-007		171.210.4
A 002 544 07 03	9EL 131 420-011	A 608 926 00 56	9EL 126 294-001	SMME31640S6	1K0 008 191-007		171.215.2
A 002 544 08 03	2VP 004 887-021	A 612 820 00 56	2KA 005 049-011	SMME31640S7	1BL 008 193-001		173.200.1
A 002 544 08 03	2VP 004 887-021	A 612 820 01 20	2BM 008 355-001	SMME31640S8	1BL 008 193-007		173.702.7
A 002 544 08 03	2VP 004 887-021	A 612 820 01 20	2BM 008 355-001	SMR910391	8GP 003 594-121		179.470.1
A 002 544 09 03	2VA 004 887-031	A 613 826 02 41	2PS 962 964-012	SMZ313636	1G3 005 760-011		179.536.7
A 002 544 12 90	9EL 134 236-041	A 613 826 02 41	2PS 962 964-018	SMZ313637	1F3 009 094-071		199.173.8
A 002 544 13 03	2SD 001 680-271	A 613 826 02 41	2PS 962 964-031	Z0412314	2XW 003 146-001		415.883.1
A 002 544 14 03	2SD 001 680-281	A 613 826 02 41	2PS 962 964-037	Z0430103	8GS 007 949-261		415.890.4
A 002 544 15 03	2SE 001 680-291	A 613 826 02 41	2PT 008 935-801	Z0430122	8GP 002 066-121		415.897.5
A 002 544 16 03	2SE 001 680-301	A 632 820 10 01	2RL 008 181-111	Z1219011	2XS 005 020-011		462.094.3
A 002 544 16 90	9EL 134 296-051	A 662 820 01 58	1GA 996 388-011	Z1219011	2XS 005 020-017		725.800.07
A 002 544 19 90	9EL 122 772-051	A 663 820 00 93	2RL 007 900-601	Z1219068	2PS 006 717-061		725.800.08
A 002 544 20 90	9EL 122 772-001	A 663 820 04 14	9XD 861 990-001	Z1219161	2PS 003 748-161		841.305.0
A 002 544 21 90	9EL 134 301-001	A 666 820 03 56	2PF 003 563-151	Z1219161	2PS 003 748-167		846.429.9
A 002 544 26 03	2VD 005 300-551	A 667 546 01 37	9GT 141 941-001	Z1219241	8GP 003 594-241		851.996.5
A 002 544 31 03	2SL 003 567-311	A 671 820 04 56	2KA 006 896-001	Z1519800	4RA 003 530-001		
A 002 544 31 94	8GH 007 643-121	A 671 820 04 56	2KA 006 896-007	Z1719041	1FE 006 300-041		
A 002 544 32 94	8GS 007 001-151	A 673 820 00 21	2BA 002 652-101	Z1719051	1NE 006 300-051		
A 002 544 40 03	2VD 005 300-581	A 673 820 00 21	2BA 002 652-107	Z1719089	8GH 002 089-133		
A 002 544 42 03	2VD 005 300-551	A 699 544 01 10	2XS 950 071-031	Z1719089	8GH 002 089-136		
A 002 544 47 90	9EL 152 891-001	A 699 544 03 03	2SK 003 567-331	Z1719090	8GH 002 090-133		
A 002 544 54 03	2VP 008 204-101	A 699 544 04 03	2SK 003 567-321	Z1719090	8GH 002 090-136		
A 002 544 55 03	2VD 008 204-111	A 700 485 00 40	2BA 002 324-001	Z1719121	8GP 003 594-121		
A 002 544 57 03	2SD 003 167-531	A 711 185 01 30	2SD 001 686-101	Z1719191	1FE 002 537-191		
A 002 544 58 03	2SD 003 167-541	A 711 185 56 50	9EL 852 061-001	Z1719201	1NE 002 537-201		
A 002 544 62 90	9EL 136 833-011	A 716 185 50 50	2KA 001 610-001	Z1719309	8KA 002 309-811		
A 002 544 63 90	9EL 136 825-011	A 716 285 02 30	2SK 003 567-331	Z1719531	1F8 007 560-561		
A 002 544 91 03	2VP 007 500-521	A 716 285 02 40	2SK 003 567-321	Z1719621	1N8 007 560-021		
A 002 544 97 03	2VP 008 204-081	A 755 601 20 02 0	2AB 004 532-051	Z1719631	1N8 007 560-031		
A 002 544 98 03	2VD 008 204-091	A 755 601 20 02 0	2AB 004 532-057	Z1719641	1F8 007 560-041		
A 002 820 34 56	2PS 006 717-077	A 758 185 00 30	2BA 002 652-101	Z1719651	1F8 007 560-051		
A 002 820 34 56	2PS 006 717-077	A 758 185 00 30	2BA 002 652-107	Z2219609	ZZR 006 609-081		
A 002 820 47 56	2PF 006 679-007	A 86 1019 4054-90	2SD 001 679-001	Z2219609	ZNR 006 609-087		
A 002 820 57 56	2XS 003 168-071	A 86 1041 0603-60	2SB 003 018-031	Z2219660	2RE 006 609-001		
A 002 820 90 56	2DA 007 421-001	A 901 820 02 56	2NE 003 315-011	Z2219660	2NE 006 609-007		
A 002 820 90 56	2DA 007 421-007	A 901 820 02 56 X	2NE 003 315-011				
A 002 822 17 10	9EL 861 597-011	A 901 820 03 56	2ZR 003 315-041	Monark-Diesel	HELLA		
A 002 822 20 78	8RA 003 326-041	A 904 820 03 56	2ZR 003 315-041	098 174 080	1G0 357 000-001		
A 002 826 20 78	8RA 003 326-047	A 939 723 10 93 01	2XS 950 071-031	098 174 080	1G0 996 276-451		
A 002 826 72 90	9EL 110 544-001	A 949 820 00 39	1K0 247 043-031	098 174 100	1G0 357 002-001		
A 003 540 22 70	2VD 007 500-221	A 949 820 00 39	1K0 247 043-037	098 174 150	1GA 357 001-001		
A 003 544 56 03	2VD 008 204-091	A 956 543 00 42	2XD 012 160-851	098 174 151	1GA 996 661-011		
A 003 544 57 03	2VP 008 204-081	A 956 820 00 39	1BL 247 042-011	098 174 151	1GA 357 001-001		
A 003 820 01 56	2DA 959 071-237	A 956 820 00 39	1BL 247 042-017	098 200 950	1GA 996 661-011		
A 003 820 13 56	2XS 005 020-001	A 956 820 02 39	1K0 247 043-021	098 212 571	2TM 357 008-021		
A 003 820 13 56	2XS 005 020-002	A 956 820 02 39	1K0 247 043-027	098 214 270	2SD 357 031-001		
A 003 820 13 56	2XS 005 020-003	A 956 825 00 02	2XD 011 557-101	098 221 290	2SK 340 101-011		
A 003 820 14 56	2XS 005 020-077	A 957 540 04 40	8HG 153 152-001	098 221 940	2PS 340 000-021		
A 003 820 26 56	1K0 008 191-021	A 957 820 00 01	2JA 006 447-041	098 221 942	2PS 357 008-001		
A 003 820 26 56	1K0 008 191-027	A 957 820 02 61	1DL 007 872-077	098 221 943	2PS 357 008-011		
A 003 820 27 56	1NO 008 582-011	A 957 820 03 61	1DL 007 872-087	098 221 944	2PS 357 008-011		
A 003 820 27 56	1NO 008 582-017	A 975 540 04 40	8HG 153 152-001	098 230 108	2PG 340 000-121		
A 003 820 59 56	2PT 009 599-131	B 999 804 34 03 13	2XD 012 160-851	098 230 800	2PG 003 057-061		
A 003 820 60 56	2PT 009 599-141	B 999 804 34 03 14	2XD 011 557-101	098 230 800	2PG 003 057-067		
A 004 545 32 26	8JB 001 943-001	B66 830 039	8GH 002 089-251	098 230 800	2PG 357 012-021		
A 004 820 00 42	9MN 858 616-001	HKV 300 000 00 01	1A6 002 395-821	098 230 960	2PG 357 008-031		
A 004 820 01 42	9MN 858 616-011	HKV 300 000 00 02	1NL 007 186-061	098 294 294	9XX 340 222-001		
A 004 821 08 51	8XX 010 315-001	HKV 300 000 00 03	2BA 002 939-251	91 124 901	8GH 002 089-251		
A 005 545 21 14	6ED 708 919-001	HKW221820T004	2XD 008 997-001	91 412 904	8GJ 002 525-131		
A 005 546 59 37	9GH 147 009-007	HKW2					

Manufacturer's no. / HELLA no.

Cross-Reference



Narva	HELLA	NATO	HELLA	NATO	HELLA	Neoplan	HELLA
47385BL	8GA 006 841-801	6220-12-173-2259	2KA 001 386-281	9390-12-169-3186	9GD 023 639-001	1102.546.4	2PF 961 167-021
47386	8GD 004 772-121	6220-12-174-0100	2PF 001 634-101	9905-12-139-8150	8RA 002 016-121	1102.547.5	1NL 007 186-021
47501	8GP 003 594-121	6220-12-174-2805	2KA 001 389-101	9905-12-162-7570	8RA 002 016-101	1102.547.5	1NL 007 186-027
47502	8GP 003 594-251	6220-12-176-0704	2JA 003 231-001	9905-12-172-5334	8RA 002 016-111	1102.547.5	2JA 005 590-001
47504	8GP 003 594-141	6220-12-176-4379	2SD 001 685-231	9905-12-175-7514	8RA 002 023-011	1102.548.8	2SA 001 638-021
47505	8GP 003 594-241	6220-12-176-4379	2SD 001 685-232	9905-12-191-1123	8RA 003 326-011	1102.548.9	2PF 001 638-011
47508	8GP 002 095-241	6220-12-178-2125	2BA 002 324-011	9905-12-191-1123	8RA 003 326-017	1102.549.1	2XS 005 020-001
47510	8GP 003 594-541	6220-12-178-3324	2BA 001 221-441	9905-12-300-2792	8RA 002 023-001	1102.549.1	2XS 005 020-002
47530	8GA 008 892-002	6220-12-178-3325	2BA 001 221-031	9905-12-306-9555	8HG 002 240-001	1102.549.1	2XS 005 020-003
47532	8GP 009 021-002	6220-12-178-3348	2BA 002 324-021			1102.549.3	2XS 007 841-011
47534	8GD 008 893-002	6220-12-178-3349	2BA 002 324-001			1102.549.3	2XS 007 841-017
47613	8GA 002 071-131	6220-12-178-3722	9EL 116 607-005			1102.553.0	2JA 004 531-011
47618	8GA 002 071-251	6220-12-178-3921	9EL 110 014-001			1102.553.0	2JA 007 372-011
47643	8GP 002 068-131	6220-12-178-3922	9EL 110 013-001			1102.553.2	2SA 001 259-751
47653	8GM 002 092-241	6220-12-178-4344	2JA 002 661-001			1102.553.2	2SA 001 259-757
47724	8GA 007 997-041	6220-12-178-4672	2BM 002 847-021			1102.554.2	2JA 003 231-001
47728	8GA 007 997-001	6220-12-178-4673	9EL 115 830-001			1102.554.5	2JA 003 354-051
47732	8GA 007 997-061	6220-12-179-5622	2SE 001 699-071			1102.554.7	2JA 001 331-011
47748	8GA 007 997-141	6220-12-180-4221	8KA 002 309-811			1102.556.6	2JA 001 364-001
47752	8GA 007 997-121	6220-12-180-9539	9EL 109 139-001			1102.558.3	2AB 004 532-051
47988	8GM 002 091-241	6220-12-180-9767	2JA 001 357-012			1102.558.3	2AB 004 532-057
47989	8GP 007 676-121	6220-12-181-0915	2BM 002 847-011			1102.558.5	9XB 136 202-005
48005	8GH 005 635-121	6220-12-181-6665	1AB 001 100-001			1102.776.1	9GT 143 133-007
48006	8GH 005 636-121	6220-12-181-6666	2ZR 003 030-171			1102.871.0	8GP 003 594-241
48077	8GH 008 357-001	6220-12-181-7671	2BA 003 014-011			1102.912.5	8KW 701 235-033
48078	8GH 008 358-121	6220-12-182-6686	2NE 001 423-011			1105.237.9	2XW 007 146-001
48320	8GH 002 089-133	6220-12-183-8555	2SD 001 699-061			1105.238.6	2XW 007 146-001
48328	8GH 007 157-121	6220-12-183-9749	9EL 088 150-001			1105779.2	2SA 005 603-021
48334BL	8GH 002 089-471	6220-12-184-8508	9EL 852 820-001			1105779.2	2SA 005 603-027
48339BL	8GH 007 157-471	6220-12-186-4524	2BA 001 277-011			1106 074.0	9GD 100 140-001
48607BL	8GH 007 157-181	6220-12-191-2085	2ZR 001 423-001			1106 390.1	2BM 008 355-001
48630	8GH 002 089-141	6220-12-191-3487	2SD 003 167-021			1106 390.1	2BM 008 355-007
48633	8GH 002 089-141	6220-12-191-3488	2SE 003 167-031			1106.173.5	8JB 004 777-001
48677	8GH 002 090-371	6220-12-192-3516	2JA 003 232-011			1106.173.5	8JB 004 777-002
48700	8GJ 002 525-361	6220-12-192-6271	2SD 002 582-011			1106.848.3	2NE 008 221-031
48702	8GH 002 090-251	6220-12-192-6272	2SD 002 582-021			1106.848.4	2NE 008 221-037
48720	8GH 002 857-241	6220-12-192-6272	2SD 002 582-027			1106.848.4	8RA 008 405-001
48728	8GH 007 157-241	6220-12-193-8425	2JA 001 335-011			1107 878.6	8RA 008 405-007
48881	8GJ 002 525-131	6220-12-194-3370	2KA 003 168-021			1107 878.6	1BL 008 194-027
48884	8GJ 004 173-121	6220-12-195-1959	2BE 003 184-051			1107 941.2	8XU 008 405-031
48888	8GJ 002 525-301	6220-12-196-2754	2PF 001 648-161			1107 941.2	8XU 008 405-037
48889	8GJ 002 525-481	6220-12-197-0647	2NE 002 985-001			1107 081.0	2XS 008 479-041
48892	8GJ 002 525-251	6220-12-197-1856	2SD 003 184-031			1107 081.0	2XS 008 479-047
48894	8GJ 003 133-242	6220-12-197-1856	2SD 003 184-037			1107 081.1	2XS 008 479-051
48898	8GJ 002 525-281	6220-12-197-3499	2SE 001 685-201			1107 081.1	2XS 008 479-057
49004	8GA 008 899-061	6220-12-197-5071	9EL 852 061-001			1107 376.4	1K0 008 191-021
49014	8GA 008 899-121	6220-12-197-6875	1GA 003 470-051			1107 376.4	1K0 008 191-027
49072	8GA 002 083-131	6220-12-198-1062	1A6 002 395-031			1107 376.7	1N0 008 582-011
49082	8GA 002 083-251	6220-12-198-1063	1A6 002 395-071			1107 376.7	1N0 008 582-017
49174	8GA 002 074-121	6220-12-198-1063	1A6 002 395-077			1107 376.8	1BL 008 193-011
49183	8GA 002 074-241	6220-12-198-3109	1G8 002 340-011			1107 376.8	1BL 008 193-017
49461	8GD 008 897-061	6220-12-198-8343	1G5 003 241-081			1107 376.8	9GH 152 654-007
49471	8GD 008 897-121	6220-12-199-2686	2SA 003 057-021			1107 377.0	2DA 959 071-737
49521	8GD 008 898-061	6220-12-300-3102	2KA 003 389-061			1107 378.7	2BA 008 221-041
49531	8GD 002 084-131	6220-12-300-3102	2KA 003 389-062			1107 378.7	2BA 008 221-047
49671	8GD 002 084-151	6220-12-300-3102	2KA 003 389-068			1107 378.9	8RA 002 016-111
49681	8GD 002 084-251	6220-12-300-7833	9EL 108 435-001			1107 379.0	2SA 008 405-011
68161	8GH 007 643-121	6220-12-301-3642	9EL 110 737-001			1107 388.1	8KA 152 134-007
		6220-12-301-4206	9EL 110 736-001			1107 496.6	1K0 008 191-041
		6220-12-301-7983	9EL 107 368-001			1107 496.6	1K0 008 191-047
		6220-12-302-3556	9EL 111 647-001			1107 535.0	2DA 005 603-031
		6220-12-302-3809	9BG 121 587-031			1107 535.0	2DA 005 603-037
		6220-12-302-3809	9BG 121 587-037			1107 535.0	2DA 005 603-031
		6220-12-302-7645	9EL 110 544-001			1108 046.8	2DA 005 603-037
		6220-12-304-4125	2SE 001 685-221			1108 046.8	2BM 006 692-011
		6220-12-304-4125	2SE 001 685-227			1108 046.9	2BM 006 692-017
		6220-12-304-6240	1H3 001 456-012			1108 046.9	2BM 006 692-021
		6220-12-311-5348	2XS 005 020-067			1108 047.0	2BM 006 692-027
		6220-99-777-3508	9XR 854 840-001			1108 047.0	2SA 006 679-027
		6220-99-803-2658	2AA 001 200-011			1108 047.1	2PS 962 964-012
		6220-99-803-2658	2AA 001 200-012			1108 047.1	2PS 962 964-018
		6220-99-806-1919	2BA 001 236-001			1108 060.8	9GT 963 129-001
		6230-12-182-5826	2XW 003 146-001			1108 061.0	9GD 963 281-001
		6240-12-120-7948	8GM 002 092-241			1108 067.9	2PF 006 679-007
		6240-12-120-7950	8GA 002 071-241			1108 253.3	2PF 003 563-151
		6240-12-120-7952	8GP 002 068-241			111 283.60	2SB 005 603-137
		6240-12-120-7956	8GM 002 092-121			111 283.60	9EL 119 544-001
		6240-12-120-7996	8GP 002 068-121			111 283.60	2SA 003 236-341
		6240-12-120-7998	8GA 002 071-121			1112 835.8	2SA 005 603-021
		6240-12-120-7998	8GA 002 071-123			1113 245.2	2SA 005 603-027
		6240-12-120-8025	8GA 002 072-241			1113 245.3	9EL 122 772-001
		6240-12-121-2685	8GM 002 094-121			1114 574.3	2SK 003 567-331
		6240-12-121-2728	8GP 002 066-241			1101 502.7	2BA 003 236-541
		6240-12-121-2732	8GD 002 084-251			1502.204.00	2ZR 001 240-377
		6240-12-124-4671	8GP 002 067-241			1502.204.00	1NL 007 186-021
		6240-12-124-9644	8GA 002 083-251			1502.205.00	1NL 007 186-027
		6240-12-127-4953	8GM 002 091-131			1502.206.00	9GH 147 009-007
		6240-12-127-4954	8GA 002 083-131			1502.207.00	1BL 007 834-007
		6240-12-129-3450	8GP 002 067-121			1503.000.00	9HD 155 239-001
		6240-12-129-3450	8GP 002 067-123			1503.004.00	1KL 007 834-027
		6240-12-129-4845	8GP 002 096-061			1503.004.01	1NL 007 834-017
		6240-12-129-4850	8GM 002 091-241			1503.005.00	2BA 005 603-117
		6240-12-129-5167	8GM 002 091-251			1503.009.00	8RA 002 016-121
		6240-12-136-1126	8GD 002 084-131			1503.010.00	2BE 004 119-021
		6240-12-137-2181	8GA 002 074-121			1503.012.00	9GT 134 655-007
		6240-12-140-5265	8GA 002 074-121			1503.013.00	9GT 143 133-007
		6240-12-147-2831	8GM 002 091-121			1503.013.00	1BL 007 834-037
		6240-12-150-4410	8GA 002 073-241			1503.016.00	2SE 997 111-011
		6240-12-151-9661	8GH 002 089-251			1503.012.00	2SE 997 111-021
		6240-12-151-9661	8GH 002 089-253			1503.043.00	9EL 119 544-011
		6240-12-159-7268	8GA 002 073-121			1503.043.00	2ZR 005 603-0



Manufacturer's no. / HELLA no. Cross-Reference

Neoplan	HELLA	Neoplan	HELLA	Neoplan	HELLA	New Holland	HELLA
1503.114.00	9GD 100 140-001	1508.377.00	8JA 004 667-001	N1.01102-5244	2PS 962 964-012	9819611	1GA 005 060-041
1503.141.00	2ZR 003 014-091	1510.005.00	8GH 002 473-151	N1.01102-5244	2PS 962 964-018	9819611	1GA 998 522-011
1503.142.00	2BM 006 692-011	1510.006.00	8GP 003 594-241	N1.01102-5245	9GT 963 129-001	9837139	1GB 006 213-101
1503.142.00	2BM 006 692-017	1510.008.00	8GA 002 071-251	N1.01102-5258	2SB 005 603-137	9837139	1GB 006 213-107
1503.143.00	2BM 006 692-021	1510.021.00	8GP 003 594-251	N1.01102-5270	2SD 003 184-031	9837140	1GA 006 991-061
1503.143.00	2BM 006 692-027	1510.305.00	8GM 002 092-241	N1.01102-5270	2SD 003 184-037		
1503.145.00	2SA 006 679-027	1511.946.00	8KW 701 235-033	N1.01102-5271	9EL 118 700-001		
1503.148.00	2PS 962 964-012	2602.042.00	2XM 004 444-001	N1.01102-5322	1NL 007 834-017		
1503.148.00	2PS 962 964-018	2602.105.00	2XW 003 146-001	N1.01102-5329	1NL 007 186-047		
1503.148.10	9GT 963 129-001	2602.119.00	2XW 003 146-001	N1.01102-5330	1BL 007 834-037		
1503.148.20	9GD 963 281-001	36.25101-6000	1K0 008 191-041	N1.01102-5344	2TM 003 748-011		
1503.160.00	2BA 003 734-061	36.25101-6000	1K0 008 191-047	N1.01102-5346	2ZR 005 603-061		
1503.203.00	2NE 003 236-001	36.25101-6001	1BL 008 193-011	N1.01102-5441	2ZR 005 603-067		
1503.203.00	2NE 003 236-008	36.25101-6001	1BL 008 193-017	N1.01102-5441	8RA 003 326-011		
1503.203.02	9EL 119 544-001	36.25101-6002	1BL 007 834-007	N1.01102-5441	8RA 003 326-017		
1503.205.02	9EL 119 544-001	36.25101-6003	1KL 007 834-027	N1.01102-5464	2PF 961 167-021		
1503.207.00	2SD 001 693-011	36.25101-6008	1NL 008 090-117	N1.01102-5491	2XS 005 020-001		
1503.208.00	2SD 003 184-041	36.25102-0000	9HD 149 253-007	N1.01102-5491	2XS 005 020-002		
1503.208.00	2SD 003 184-047	36.25102-0000	1NO 008 582-011	N1.01102-5491	2XS 005 020-003		
1503.209.00	2SD 003 184-031	36.25102-0000	1NO 008 582-017	N1.01102-5493	2XS 007 841-011		
1503.209.00	2SD 003 184-037	36.25102-6004	1NL 008 090-327	N1.01102-5493	2XS 007 841-017		
1503.211.00	2SA 003 236-341	36.25103-6000	2ZR 008 221-051	N1.01102-5538	9EL 856 010-001		
1503.212.00	2SA 003 236-041	36.25103-6000	2ZR 008 221-057	N1.01106-7301	2VP 007 323-101		
1503.212.00	2SA 003 236-048	36.25103-6003	2ZR 001 240-377	N1.01106-7310	2VP 007 323-091		
1503.212.01	9EL 119 544-031	36.25109-0000	9HD 149 253-007				
1503.216.00	2SA 005 603-021	36.25115-0000	9AH 161 796-017				
1503.216.00	2SA 005 603-027	36.25140-6000	9XB 152 977-001				
1503.222.00	2SK 003 567-321	36.25201-6010	2JA 004 531-011				
1503.222.02	9EL 122 772-001	36.25201-6012	2JA 005 590-001				
1503.223.00	2ZR 001 240-377	36.25201-6013	2JA 003 231-001				
1503.226.00	2BA 003 236-541	36.25202-6003	2AB 004 532-051				
1503.23	2SD 003 167-011	36.25202-6003	2AB 004 532-057				
1503.230.00	2ZR 001 240-377	36.25205-6000	2JB 996 012-121				
1503.232.00	2SD 003 184-041	36.25225-6000	2XA 008 221-021				
1503.232.00	2SD 003 184-047	36.25225-6000	2XA 008 221-027				
1503.239.00	1NL 007 186-047	36.25225-6001	2NE 008 221-037				
1503.240.00	1K2 006 147-031	36.25225-6002	2NE 008 221-037				
1503.241.00	2BA 004 119-001	36.25225-6002	2DA 959 071-737				
1503.242.00	2BA 005 603-011	36.25225-6006	2DA 005 603-031				
1503.242.00	2BA 005 603-017	36.25225-6006	2DA 005 603-037				
1503.244.00	1KL 007 834-027	36.25225-6007	2SA 005 603-021				
1503.245.00	1NI 007 834-017	36.25225-6007	2SA 005 603-027				
1503.250.01	9GT 134 655-007	36.25225-6008	2SD 003 184-031				
1503.250.02	9GT 143 133-007	36.25225-6008	2SD 003 184-037				
1503.252.00	1BL 007 834-037	36.25225-6009	2SD 003 184-041				
1503.253.00	2SD 003 184-031	36.25225-6009	2SD 003 184-047				
1503.253.00	2SD 003 184-037	36.25225-6015	2PS 009 226-017				
1503.28	2SD 003 167-021	36.25240-6000	2KA 005 049-011				
1503.300.00	2ZR 002 694-001	36.25240-6000	2KA 005 049-017				
1503.301.00	2ZR 001 193-011	36.25260-6000	2PF 008 221-011				
1503.302.00	2ZR 003 236-311	36.25260-6000	2PF 008 221-017				
1503.303.00	2TM 003 748-011	36.25260-6001	2SA 008 405-011				
1503.303.01	9EL 119 544-111	36.25260-6001	2SA 008 405-017				
1503.307.00	2ZR 005 603-061	36.25260-6004	2XS 008 479-051				
1503.307.00	2ZR 005 603-067	36.25260-6004	2XS 008 479-057				
1503.380.00	2SA 001 647-041	36.25260-6005	2XS 008 479-041				
1503.400.00	2KA 001 378-041	36.25260-6005	2XS 008 479-047				
1503.401.00	2KA 005 049-008	36.25260-6009	2PF 003 563-187				
1503.402.00	2KA 003 389-061	36.25260-6010	2PF 006 679-007				
1503.402.00	2KA 003 389-062	36.25320-6001	2BA 008 221-041				
1503.402.00	2KA 003 389-068	36.25320-6001	2BA 008 221-047				
1503.403.00	2KA 001 622-001	36.25320-6004	2BE 004 119-021				
1503.407.00	2KA 003 168-021	36.25320-6005	2BA 005 603-117				
1503.408.00	2KA 005 049-011	36.25320-6006	2BM 008 355-017				
1503.408.00	2KA 005 049-017	36.25323-000	8XU 008 405-031				
1503.511.10	1F8 007 560-411	36.25323-000	8XU 008 405-037				
1503.513.00	1FD 003 590-411	36.25943-6007	5DV 008 856-001				
1503.527.00	1GD 003 590-701	36.25943-6007	5DV 008 856-007				
1503.541.20	2XS 005 020-041	36.96001-0001	9GH 145 943-001				
1503.541.20	2XS 005 020-047	81.25205-6008	2JB 996 012-121				
1503.700.00	8RA 003 326-011	81.25225-6107	2BM 002 847-011				
1503.700.00	8RA 003 326-017	81.25225-6108	8GM 002 847-021				
1503.700.10	8RA 003 326-041	81.25225-6459	2BM 006 692-011				
1503.700.10	8RA 003 326-047	81.25225-6459	2BM 006 692-017				
1503.700.50	8RA 003 326-021	81.25229-0244	9EL 122 772-001				
1503.701.00	8RA 003 660-007	81.25901-0016	8GA 002 073-241				
1503.702.00	8RL 002 009-021	81.25901-0102	8GA 006 841-241				
1503.704.00	8RL 002 009-021	81.42950-0028	8RL 002 009-021				
1503.743.00	8RB 004 713-001	81.42950-0043	8RA 003 660-007				
1503.746.00	2XS 955 031-001	81.42950-0065	8RA 003 326-001				
1503.801.00	2PF 001 647-031	81.42950-0065	8JA 003 326-002				
1503.801.00	2PF 001 647-037	81.25201-6001	2JA 001 330-001				
1503.802.00	2PF 961 167-021	82.25201-6001	2JA 003 354-051				
1503.804.00	2SA 004 014-051	82.25225-6031	2SK 003 567-331				
1503.805.00	2PF 003 014-071	83.25205-6001	2JA 001 364-001				
1503.811.00	2JA 005 590-001	84.25901-0021	8GA 002 074-241				
1503.817.00	2PF 004 081-001	88.25101-6006	1BL 008 194-027				
1503.817.00	2PF 004 081-007	88.25101-6007	1K0 008 191-021				
1503.905.00	2SA 001 638-021	88.25101-6007	1K0 008 191-027				
1503.906.00	2PF 001 638-011	88.25215-0001	8RA 008 405-001				
1503.907.00	2XS 005 020-001	88.25215-0001	8RA 008 405-007				
1503.907.00	2XS 005 020-002	88.25225-6012	2BA 001 221-031				
1503.907.00	2XS 005 020-003	88.25225-6023	2BA 003 236-541				
1503.907.01	9EL 132 215-001	88.25225-6026	2BA 008 221-001				
1503.907.10	2XS 007 841-011	88.25225-6026	2BA 008 221-007				
1503.907.20	2XS 007 841-017	8800 209 7	8GA 002 071-241				
1504.012.00	2JA 003 236-357	8800 783 7	2ZR 005 603-061				
1504.016.00	2JA 004 531-011	8800 784 0	2ZR 005 603-067				
1504.019.00	9EL 856 010-001	8800 784 0	2BA 005 603-011				
1504.019.00	2SA 001 259-751	8800 855 4	2BA 005 603-017				
1504.019.00	2SA 001 259-757	8800 957 3	2PF 961 167-021				
1504.027.00	2JA 001 335-011	8801 050 9	8GS55763				
1504.032.00	2JA 003 231-001	8801 050 9	2BM 006 692-021				
1504.033.00	2JA 002 661-001	8801 526 8	2BM 006 692-027				
1504.037.10	9EL 120 240-011	8801 526 8	2ZR 003 236-051				
1504.039.00	2JA 001 331-011	8801 526 9	2ZR 003 236-057				
1504.041.00	9EL 855 097-001	8803 408 5	9EL 119 544-111				
1504.106.00	2JA 001 364-001	8803 408 5	2PF 959 590-207				
1504.207.00	2AB 004 532-051	N1.01102-5087	2NE 005 603-071				
1504.207.00	2AB 004 532-057	N1.01102-5087	2NE 005 603-077				
1504.207.05	9XB 136 202-005	N1.01102-5089	2SK 003 567-661				
1504.637.10	9EL 120 240-01						

Manufacturer's no. / HELLA no.

Cross-Reference



O & K	HELLA	O & K	HELLA	O & K	HELLA	O & K	HELLA
0264485	8GA 002 071-251	1494060	8GH 002 089-136	2764283	2RL 008 181-111	8412674	2BA 003 022-001
0264485	8GA 002 071-258	1494061	9EL 860 627-001	2764293	5KG 007 629-011	8412675	2SE 001 699-071
0264745	2BE 003 185-031	1494063	9MM 860 677-001	2764316	1GA 998 534-011	8412692	2BA 003 734-061
0339992	2BA 002 324-001	1494134	9EL 964 532-001	2764317	8GS 007 949-261	8412695	2BE 003 014-251
0430879100	2JA 001 357-002	1495770	9EL 964 531-001	2764366	8GS 007 949-261	8412695	2BE 003 014-257
0434011800	2JA 003 231-001	1520715	2SK 003 567-321	2764793	2JA 007 373-071	8412742	1AG 003 434-137
0490772	8XS 113 389-001	1520716	2SK 003 567-331	2764945	1GA 996 142-011	8412748	1G5 003 241-071
0490775	2AA 001 200-131	1537245	8RA 003 326-041	2764945-301	1GA 996 142-011	8413050	2PF 001 648-161
0490776	2AA 001 200-141	1537245	8RA 003 326-047	2781686	2VP 006 040-111	8413122	2JA 003 231-001
049775	2AA 001 200-131	1537807	2JA 003 354-001	2781686	2VP 006 040-117	8413715	6ED 708 919-001
0505650	1G8 002 340-001	1547165	2JA 001 357-002	2781687	2VP 006 040-121	8413762	9EL 854 912-001
0511591	2BA 002 324-011	1547294	1AG 003 434-051	2781687	2VP 006 040-127	84353139	2BE 997 006-101
0511592	2BA 002 324-021	1570318	8JA 001 909-001	2900359	8GM 002 092-121	8436822	9GT 074 132-001
0524903	2BA 001 221-031	1570424	9BG 127 426-001	2928271	1GA 006 876-001	8436830	9EL 115 003-055
0524904	2BA 001 221-041	1570425	1AA 004 109-031	2928273	2RL 007 552-001	8464232	2SA 001 634-121
0552314	2BA 002 652-121	1589164	1A7 003 099-011	2928304	8GD 002 078-121	8464263	2BE 003 182-101
0552314	2BA 002 652-127	1589704	150 001 430-011	2928305	8GD 002 078-241	8464299	2XS 950 071-031
0552315	2BA 002 652-111	1709575	1AA 004 109-041	2928305	8GD 002 078-248	8464300	2XS 005 020-001
0552315	2BA 002 652-117	1709675	1AA 004 109-041	2928339	2SD 964 169-111	8464300	2XS 005 020-002
0559299	8GH 002 090-133	1710080	8HG 002 365-001	2928339	2SD 964 169-117	8464301	2XS 005 020-003
0559299	8GH 002 090-136	1710088	8HG 002 365-001	2928340	2ZR 964 169-031	8464301	2XS 005 020-011
0576426	2SE 002 578-701	1710097	2SB 003 018-031	2928340	2ZR 964 169-037	8464301	2XS 005 020-017
0576426	2SE 002 578-707	1710145	2KA 001 389-101	2928380	2RL 007 552-011	8464788	2PF 003 389-037
0590880	2BA 003 014-111	1710154	2SD 001 693-011	2928475	8GA 002 071-131	8464953	2AB 004 532-051
0591342	2SB 003 014-151	1710167	2BA 002 324-011	2928475	8GA 002 071-133	8464953	2AB 004 532-057
0591900	2ZR 001 193-011	1710168	2BA 002 324-021	2928660	8HG 003 799-001	8467019	9EL 110 544-001
0597009	2SD 002 776-231	1710176	2BA 002 324-001	2928667	2TM 003 057-031	8467027	9FH 093 887-001
0597009	2SD 002 776-237	1710177	2SD 001 686-101	2929066	1AB 006 213-011	8467099	1A3 001 120-001
0597064	2SD 002 776-241	1710178	2SD 001 699-061	2929205	2BA 996 012-061	8467158	9XR 854 840-001
0597064	2SD 002 776-247	1710201	2BA 003 022-001	2929206	9BG 993 345-001	8475319	1N4 002 608-021
0598671	2SW 003 014-131	1710202	2PS 002 727-001	2929704	2PF 996 012-051	8476344	2XS 955 031-001
06911864	9EL 990 354-131	1710205	2SE 001 699-071	2929867	2XS 005 020-001	8482092	9EL 146 491-001
06916169	1A3 002 850-031	1710217	2BA 002 652-101	2929902	8HG 006 294-051	8482692	9EL 855 097-001
06916172	9EL 990 354-121	1710218	2BA 002 652-107	2929939	9BG 990 042-061	8485655	9EL 856 418-001
06916173	9EL 990 354-141	1710218	2KA 003 389-001	2929941	2BA 996 012-147	8488471	2RL 008 060-111
0718942	2SD 001 685-211	1710218	2KA 003 389-062	2929942	8HG 006 294-091	8488472	2RL 008 061-111
0718942	2SD 001 685-218	1710218	2KA 003 389-068	2930153	2RL 008 062-101	8519965	2SA 003 057-021
0726334	8RL 002 009-021	1710218	2KA 003 389-068	2937835	2KA 001 389-101	8520062	2PF 003 057-041
0726357	1G5 132 233-011	1710220	2BA 002 652-111	2976502	8GA 002 073-241	8520691	9EL 117 330-011
0726532	8GP 002 095-241	1710220	2BA 002 652-117	2976502	8GA 002 073-248	937501	2BA 001 423-087
0760569	2ZR 003 014-091	1710221	2BA 002 652-121	2978085	2BA 002 652-101	937501	2SB 001 423-097
0762923	9EL 113 639-021	1710221	2BA 002 652-127	2978085	2BA 002 652-107	970097	2PF 001 259-631
0763043	9ES 106 588-001	1710243	2BA 003 734-061	2978643	2SD 002 776-231	BER511591	2BA 002 324-011
0900585	8GS 002 296-111	1710248	2BE 003 014-251	2978643	2SD 002 776-237	BER511592	2BA 002 324-021
0933179	1A5 003 178-411	1710248	2BE 003 014-257	2978738	2SW 003 014-131		
0933387	2JA 004 531-011	1710265	2BE 003 182-091	2981212	1AB 004 231-001		
0933953	1G8 002 340-011	1710266	2BE 003 182-101	2981369	1GB 006 213-101		
0944197	9GT 067 751-001	1710312	2XS 950 071-031	2981369	1GB 006 213-107		
0944924	8GJ 002 525-251	1710313	2XS 005 020-001	3004752	2BN 964 169-051		
0944924	8GJ 002 525-258	1710313	2XS 005 020-002	3004752	2BN 964 169-057		
0944925	1A5 003 190-001	1710313	2XS 005 020-003	3004753	2TA 964 169-061		
0945429	2AA 001 200-041	1710318	2BA 003 014-111	3004753	2TA 964 169-067		
0971531	1G5 003 241-021	1710319	2XS 955 031-001	3005654	2BA 996 012-147		
0971532	2KA 003 389-061	1711003	8RA 002 016-111	30230	8GM 002 092-241		
0971532	2KA 003 389-062	1711052	8RA 003 326-011	30234	2SD 001 679-001		
0971532	2KA 003 389-068	1711052	8RA 003 326-017	33766	8RA 002 016-111		
0987118	8HG 002 365-001	1712038	8JA 001 909-011	34784	8GA 002 071-251		
0987253	2XW 003 146-001	1712099	1G9 001 523-021	34784	8GA 002 071-258		
108719	1AB 001 100-001	1712118	2ZR 001 423-001	3712131	1GM 996 136-192		
1100111	8HG 006 294-011	1712132	1G5 003 241-021	3764993	2JA 343 720-121		
1101139	1A3 005 760-518	1712138	1AG 003 434-137	37752	8GP 002 068-241		
1101141	1EA 007 108-011	1712140	2ZR 003 014-091	4158653	2JA 001 330-001		
1101141	1EA 007 108-021	1712152	1G5 003 241-071	4158653	2JA 001 330-007		
1101141	1EA 007 108-027	1712154	1G8 002 340-001	4158672	1AB 001 100-001		
1101147	9EL 113 324-001	1712218	2KA 003 389-061	4158831	2SD 001 685-211		
1101168	2XW 003 146-001	1712218	2KA 003 389-062	4158831	2SD 001 685-218		
1101218	2ZR 001 193-011	1712218	2KA 003 389-068	4158831	2SD 001 685-231		
1101234	2BA 003 022-021	1719025	2AA 001 200-011	4158831	2SD 001 685-232		
1101611	1S0 001 430-011	1719025	2AA 001 200-012	4158904	9EL 109 139-001		
1101907	2TM 003 057-031	1719026	2AA 001 200-021	4158975	9EL 113 324-001		
1102000	8GH 002 089-251	1719026	2AA 001 200-023	4619240	2ZR 003 236-051		
1102000	8GH 002 089-253	1719027	2AA 001 200-031	4619240	2ZR 003 236-057		
1102000	8GH 002 089-258	1719028	2AA 001 200-031	4620943	1AB 004 231-001		
1102049	8HG 004 806-001	1725775	2KA 003 168-021	47879740	8GD 002 088-271		
1102774	9GT 341 438-007	1732001	2PF 001 648-161	524951	2KA 003 389-061		
1141127	1G4 004 480-001	1732003	2PF 001 638-011	524951	2KA 003 389-062		
1148548	1G5 003 241-081	1737027	2JA 003 231-001	576427	2BA 002 652-101		
1185972	1G4 003 470-031	1740048	1G4 003 470-051	576427	2BA 002 652-107		
118653	8GH 002 090-251	1794577	9EL 102 240-031	597484	8GP 002 095-121		
118653	8GH 002 090-253	1794676	9GD 120 670-001	598034	2SA 003 014-051		
118653	8GH 002 090-258	1794677	9ED 708 919-001	6914613	9EL 964 536-001		
1186734	1A3 005 760-501	1794701	9EL 113 639-021	6916171	9EL 990 354-131		
1186734	1A3 005 760-507	1795243	9ES 015 675-001	69164172	9EL 990 354-121		
1186780	2SD 003 184-041	1795353	9GD 024 183-001	7300981	9EL 856 416-001		
1186780	2SD 003 184-047	1795431	9ES 106 588-001	7723-462	1VB 005 444-037		
1186781	2SD 003 184-031	1830847	9AG 104 328-001	7751280	8HG 006 294-021		
1186781	2SD 003 184-037	1909007	8GJ 002 525-131	7903855	2AB 001 208-001		
1190339	8JA 003 526-001	1909007	8GJ 002 525-136	8000013	8GM 002 091-261		
1190607	2BA 003 014-011	1909395	1TA 003 570-101	8002612	9EL 092 435-011		
1403806	8GP 002 095-241	1960077	1GA 005 060-001	8003720	2BE 002 582-031		
1406845	1A5 118 740-001	1960077	1GA 998 522-011	8003833	2KA 001 386-231		
1406969	9GD 120 670-001	1960077	1GA 005 060-001	8003954	2SD 001 686-101		
1418225	9ES 120 743-001	1960077	2ZR 003 236-311	8005804	9EL 112 744-001		
1419468	9ES 012 060-011	1960733	2PF 004 081-007	8006504	9EL 102 240-031		
1422854	1AA 126 924-035	1960733	2PF 004 081-007	8011905	8RA 003 326-011		
1424245	8RA 003 326-001	1991738	1AA 004 109-021	8011905			



Manufacturer's no. / HELLA no.

Cross-Reference

Opel	HELLA	Opel	HELLA	Osram	HELLA	Philips	HELLA
39 00 017	2BA 003 236-027	V27605030	2KA 001 386-281	64196-01B	8GJ 002 525-258	021.1203	8GA 002 071-121
40 27 500	8GA 002 083-131	V28605050	8GH 002 090-133	64196LTS	8GJ 002 525-511	021.1206	8GA 002 071-131
4027100	8GA 002 072-121	V28605050	8GH 002 090-136	64198	8GJ 004 173-121	021.1303	8GA 002 071-241
40936	2RL 008 061-101	V28605420	2SK 003 567-321	64210	8GH 007 157-121	021.1306	8GA 002 071-251
41 23 200	8GH 002 084-131	V28610250	2BA 001 227-201	64210 NBP	8GH 178 560-491	021.1313	8GA 002 071-261
41 23 600	8GA 002 072-241	V28610300	2BA 003 022-021	64210 NBP	8GH 178 560-493	021.1316	8GA 002 071-271
41 50 200	9EL 052 476-001	V29615040	8RA 002 016-121	64210CB	8GH 007 157-181	021.2114	8GP 002 067-061
41101	2JA 007 373-001	V29700301	2XS 005 020-021	64210D-01B	8GH 007 157-201	021.2208	8GP 002 068-121
42075	1GA 378 284-001	V43058900	1A5 003 190-001	64210L	8GH 007 157-201	021.2210	8GP 002 066-121
42272	2XD 008 997-001	V44022500	2SE 002 578-701	64210NBR	8GH 007 157-533	021.2214	8GP 002 067-121
43093	1GA 996 142-041	V44022500	2SE 002 578-707	64210NBR	8GH 007 157-533	021.2308	8GP 002 068-241
43175700	8GD 002 084-131	V44029700	2BA 001 227-201	64210SVS	8GH 007 157-471	021.2310	8GP 002 066-241
43175800	8GA 002 083-131	V46021300	2SW 003 014-131	64210ULT-02B	8GH 007 157-181	021.2314	8GP 002 067-241
43191200	8GJ 002 525-131	V46059200	2BA 003 014-011	64210ULT-02B	8GH 007 157-186	021.2324	8GP 002 067-261
43191200	8GJ 002 525-136	V46061300	2BA 003 014-111	64210ULT-02B	8GH 007 157-453	021.3201	8GM 002 094-121
43206400	4RA 965 400-001	V46063500	2ZR 003 014-091	64211	8GH 008 358-121	021.3203	8GM 002 092-121
43206500	8GA 002 083-251	V47001900	8RA 003 503-001	64212	8GH 008 356-121	021.3205	8GM 002 091-131
43206600	1TA 003 570-101	V99120130	2AA 001 200-001	64213	8GH 008 357-001	021.3209	8GM 002 091-141
44 590	9SX 010 391-001	V99120290	8HG 002 365-001	64215	8GH 007 157-241	021.3211	8GM 002 091-121
44 591	9SX 010 392-001	V99120380	2AA 001 200-011	64215-01B	8GH 007 157-248	021.3301	8GM 002 094-241
44 592	9SX 010 393-801	V99120380	2AA 001 200-012	64215-01B	8GH 007 157-248	021.3303	8GM 002 092-241
44 594	9MM 863 164-051	V99120380		64215LTS	8GH 007 157-231	021.3305	8GM 002 091-251
44001600	9EL 052 476-001			64216LTS	8GH 008 358-251	021.3311	8GM 002 091-241
44061	2JA 343 720-121			6423	8GM 002 092-241	021.4205	8GH 002 473-151
44593	8KB 174 934-001			6428	8GM 002 094-121	021.6202	8GP 003 594-141
44608	9GD 176 514-871			6429	8GM 002 091-251	021.6212	8GP 002 095-121
45074	8KB 174 943-001			6430	8GM 002 094-241	021.6252	8GP 003 594-121
45151	8KB 173 872-001			6451	8GM 002 091-141	021.6302	8GP 003 594-241
45248	9MK 860 255-001			6453	8GM 002 091-261	021.6312	8GP 002 095-241
45249	9SX 008 902-021			6475	8GM 002 091-121	021.6352	8GP 003 594-251
45250	8HG 863 383-001			6476	8GM 002 091-181	021.7362	8GH 007 643-121
45251	9MM 859 356-801			6480	8GM 002 091-241	120.23	8GH 002 473-151
60 35 200	2SA 003 014-051			66144	8GS 009 028-111	120.24CP	8GH 002 473-191
60 56 400	2SE 004 623-001			66144CBI	8GS 009 028-621	120.59C1	8GH 008 991-021
60 56 400	2SE 004 623-007			66240	8GS 007 949-261	120.60C1	8GH 008 991-031
80 20 100	9EL 074 484-031			66240CBI	8GS 007 949-251	12008	8GA 008 899-121
80 41 600	8GA 002 074-121			66250	8GS 007 001-151	12025	8GH 002 473-132
80 43 000	8GD 002 078-121			66250CBI	8GS 007 001-241	12036	8GH 007 643-121
89 83 807	2KA 001 622-001			66340	8GS 009 028-311	12052	8GP 007 676-121
90009587	2AA 003 257-041			66440	8GS 007 949-311	12061	8GP 838 026-001
90009587	2AA 003 257-042			7130	8GA 008 899-061	12067	8GA 008 246-001
90016718	2NE 002 985-001			7135	8GA 008 899-121	12227	8GA 002 083-131
90017882	2KA 001 386-281			7225	8GD 004 772-121	12256	8GP 003 594-141
90019237	6ZE 001 759-051			7309	8GA 002 083-131	12258BV	8GH 002 089-141
90033942	2JA 001 330-031			7323	8GD 008 897-061	12258LL	8GH 002 089-351
90053687	9GH 116 966-011			7324	8GD 008 898-061	123.42HD	8GA 002 525-301
90140379	1A6 002 395-071			7326	8GD 008 897-121	12336	8GH 002 090-131
90140379	1A6 002 395-077			7327	8GD 002 084-131	12336BV	8GH 002 090-371
90141523	2BA 003 022-021			7351	8GD 002 084-151	12342	8GJ 002 525-131
90141524	2AA 003 257-031			7360	8GD 002 084-251	12342ZV	8GJ 002 525-361
90188655	2BA 001 227-211			7409	8GA 002 083-251	12342LL	8GJ 002 525-481
90188724	6ED 004 778-001			7504	8GP 009 021-002	12342ZVP	8GJ 002 525-471
90271592	2AB 004 532-011			7505	8GA 008 892-002	12342XP	8GJ 002 525-531
90271592	2AB 004 532-021			7506	8GA 002 073-121	12356CP	8GH 008 417-001
90295524	2AB 004 532-001			7506L	8GA 002 073-271	12356LL	8GH 008 417-001
90349849	2JA 001 364-001			7507	8GA 006 841-121	12360	8GH 008 356-121
90369131	8HG 854 516-001			7507	8GA 006 841-123	12361	8GH 008 357-001
90398690	8JA 003 526-001			7507LDA	8GA 006 841-801	12362	8GH 008 358-121
90485075	9GD 856 863-001			7510	8GA 006 841-241	12362	8GH 008 358-151
90487918	9GD 858 086-001			7511	8GA 002 073-241	12396	8GP 003 594-541
90544283	2JA 001 364-001			7511-02B	8GA 002 073-241	124.96	8GA 006 841-121
91 20 067	2XW 007 146-001			7511-02B	8GA 002 073-248	12445	8GA 002 072-121
91 59 282	2BA 002 324-011			7511HD	8GA 002 073-251	12498	8GA 002 073-121
91 59 283	2BA 002 324-021			7515	8GD 008 893-002	12498LL	8GA 002 077-121
91 59 284	8GA 002 073-121			7527	8GA 002 072-121	12499	8GD 002 078-121
91 59 284	8GA 002 073-123			7528	8GD 002 078-121	12499LL	8GD 002 078-221
92 93 179	8HG 002 365-001			7528L	8GD 002 078-221	125.94	8GD 004 772-121
99044500	8HG 006 294-031			7535	8GA 002 072-241	12516	8GA 007 997-011
99049100	8GA 002 071-241			7537	8GD 002 078-241	12516	8GP 002 095-121
99049100	8GA 002 071-248			7569	8GA 002 074-121	12600	8GA 007 997-001
99050000	8GP 002 095-121			7669	8GA 002 074-241	12718	8GD 008 897-121
99073100	8GH 002 089-133			880	8GH 008 991-021	12728	8GD 002 084-131
99073100	8GH 002 089-136			881	8GH 008 991-031	12748	8GD 002 084-151
99120710	8GA 002 071-251			9005	8GH 005 635-121	128.03	8GM 002 091-181
99120710	8GA 002 071-258			9006	8GH 005 636-121	12807	8GM 002 091-121
E-X0531306AA	6ED 004 778-001			9006XS	8GH 005 636-201	12814	8GM 002 071-131
J03040078	2DA 003 014-031			921	8GA 008 246-001	12818	8GM 002 094-121
J03040078	2DA 003 014-037			94193	8GJ 002 525-301	12821	8GA 002 071-121
J03040091	2SA 003 014-051			94196	8GJ 002 525-281	12829	8GP 002 066-121
PR0531060	2ZR 003 315-041			9507	8GA 006 841-241	12844	8GM 002 092-121
PR0531975	2KA 003 389-061			9511	8GA 002 073-251	12850	8GM 002 091-141
PR0531975	2KA 003 389-062			9627	8GA 002 071-261	12866	8GM 002 091-131
PR0531975	2KA 003 389-068			9637	8GA 002 071-271	129.72	8GH 007 157-121
PR0532202	2SD 003 182-051			9930	8GP 002 067-261	12910	8GP 002 068-131
PR0532202	2SD 003 182-052			L8/29	8GS 002 296-101	12913	8GP 002 068-121
PR0532202	8RA 002 016-121			L8/33	8GS 002 296-111	12929	8GP 002 067-121
PR0532202	2XW 003 146-001			64150-01B		12961	8GP 003 594-121
PRK000489	2KA 005 049-011			64150CB	8GH 002 089-141	12961BV	8GP 003 594-261
PRK000489	2KA 005 049-017			64150CB-01B	8GH 002 089-141	12972BV	8GH 007 157-181
PRK000489	8RA 004 412-001			64150CB-02B	8GH 002 089-146	12972LL	8GH 007 157-201
PRK000588	2XW 003 146-001			64150L	8GH 002 089-351	12972XP	8GH 007 157-531
PRK000607	2AA 003 257-041			64150NBR	8GH 002 089-531	13227	8GA 002 083-251
PRK000607	2BA 002 324-001			64150SVS	8GH 002 089-471	13256	8GH 002 089-251
PRK000607	2SD 001 699-061			64151	8GH 002 090-133	13258HD	8GH 002 089-361
PRK000607	2SD 001 699-511			64151-01B	8GH 002 090-136	133.42	8GJ 002 525-251
PRX002669	1TA 003 570-101			64151CB	8GH 002 090-371	13311	8GH 002 857-241
PRX002669	1TA 003 570-101			64155	8GH 002 089-251	13336	8GH 002 090-251
V01049500	2SB 003 018-031			64155-01B	8GH 002 089-258	13342HD	8GJ 002 525-281
V03015300	1G5 003 241-081			64155-01B	8GH 002 090-251	134.9HD	8GA 002 073-251
V04027900	2AA 001 200-031			64156	8GH 002 090-251	13445	8GA 002 072-241
V04029400	2AA 001 200-011			64156-01B	8GH 002 090-258	13498	8GA 002 073-241
V04029400	2AA 001 200-012			64156LTS	8GH 002 090-471	13499	8GD 002 0

Manufacturer's no. / HELLA no.

Cross-Reference



Philips	HELLA	Renault	HELLA	Saab	HELLA	SAW	HELLA
13850	8GM 002 091-261	50 10 168 934	8RA 003 326-041	04 15 761	2XD 003 022-061	20.196-011	2PS 006 717-051
13866	8GM 002 091-251	50 10 168 934	8RA 003 326-041	04 19 888	2KA 003 389-061	20.196-011	2PS 006 717-057
139.72	8GH 007 157-241	50 10 174 173	2AB 004 532-051	04 19 888	2KA 003 389-062	20.196-021	2PS 006 717-061
13913	8GP 002 068-241	50 10 174 173	2AB 004 532-057	04 19 888	2KA 003 389-068	20.196-031	2TM 006 717-047
13929	8GP 002 067-241	50 10 256 873	2XZ 007 146-011	04 33 408	2ZR 001 240-351	20.196-041	2PG 006 717-021
13929 HD	8GP 002 067-261	54 30 064 863	2XS 950 071-031	04 51 756	2SA 003 734-121	21.001-021	2SE 001 699-071
13961	8GP 003 594-251	58 10 116 298	1EA 007 108-011	04 51 757	2DA 003 734-011	21.001-031	2SD 001 699-061
243.56CP	8GH 008 417-012	58 10 116 298	1EA 007 108-017	04 53 090	8XS 113 389-001	21.001-071	2SD 001 699-511
24362MD	8GH 008 358-251	58 10 116 299	1EA 007 108-021	06 33 415	8JA 001 909-001	21.002-011	2SE 001 688-151
24362ZML	8GH 008 358-241	58 10 116 299	1EA 007 108-027	06 961	2SA 003 057-021	21.002-031	2SD 001 688-141
42402	8GS 007 949-311	6025411PRO	2ZR 006 609-081	10 663	2ZR 001 193-011	21.002-051	2SE 001 688-161
42403	8GS 009 028-311	6025411PRO	2ZR 006 609-087	14 129	2ZR 002 694-001	21.002-071	2SD 001 688-171
6718	8GD 008 897-061	77 00 057 963 A	1GA 007 506-111	15 09 319	2SD 001 688-141	21.003-001	2SE 002 582-071
6728	8GD 008 898-061	77 00 066 386	1BL 008 193-001	15 761	2XD 003 022-061	21.003-011	2SD 002 582-021
6929	8GP 002 067-061	77 00 066 386	1BL 008 193-007	17 247	9GD 102 484-001	21.003-051	2SD 002 582-011
7008	8GA 008 899-061	77 00 066 387	1BL 008 193-001	19 888	2KA 003 389-061	21.006-001	2SE 997 006-011
7212.032.59681	8JA 001 914-011	77 00 066 387	1BL 008 193-007	19 888	2KA 003 389-062	21.006-011	2SD 997 006-021
7212.032.74111	5DV 008 855-001	77 00 066 388	1K0 008 191-011	19 888	2KA 003 389-068	21.006-221	2SD 997 006-031
7212.032.74111	5DV 008 855-007	77 00 066 388	1K0 008 191-017	25 552	2ZR 001 423-001	21.007-001	2SE 002 776-211
85122	8GS 007 949-261	77 00 067 781	9GH 152 654-007	27 751	8XS 113 389-001	21.007-011	2SD 002 776-231
85122 HID+	8GS 007 949-261	77 00 074 534	1GA 996 161-301	286 017	2JA 003 231-001	21.007-081	2SE 003 182-011
85122VIC1	8GS 007 949-251	77 00 074 535	1GA 996 161-301	286 557	2JA 003 231-001	21.007-091	2SD 003 182-061
85126	8GS 007 001-151	77 01 039 174	8GP 938 026-001	286 577	2JA 003 231-001	21.007-121	2SE 002 776-221
85126 HID+	8GS 007 001-151	77 01 363 204	2XW 007 146-001	33 203	2PS 002 727-001	21.007-131	2SD 002 776-231
85126VIC1	8GS 007 001-241	77 01 363 210	2XW 002 897-051	33 408	2ZR 001 240-351	21.007-141	2SE 003 182-021
85410	8GS 009 028-111	77 01 366 010	2BE 003 184-061	33 568	9EL 113 639-021	21.007-151	2SD 003 182-051
85415	8GS 009 028-111	77 01 366 011	2BE 003 184-051	39 096	9EL 113 928-001	21.008-001	2SE 997 008-001
85415VIC1	8GS 009 028-621	77 01 366 012	2SE 002 578-701	40 354	8RA 003 734-101	21.008-041	2SE 002 578-701
9005	8GH 005 635-121	77 01 366 012	2SE 002 578-707	43 219	2SE 001 688-151	21.009-101	2SE 001 686-142
9006	8GH 005 636-121	77 01 366 014	2ZR 002 694-001	43 220	2SE 001 688-161	21.009-111	2SD 001 686-101
9008	8GJ 008 837-121	77 03 097 178	8GA 006 841-123	43 81 448	9FF 085 642-001	21.010-101	2SE 001 685-201
		77 03 097 178	9EL 113 928-001	49 111	9ES 106 588-001	21.010-111	2SD 001 685-211
		83 08 133 787		509 319	2SD 001 688-141	21.010-121	2SE 001 685-221
				57 947	2BA 003 022-021	21.010-131	2SD 001 685-231
				61 225	2PG 002 727-021	21.017-121	2XS 005 639-001
				63 047	9GD 100 140-001	21.026-011	2TF 001 259-761
				656 187	8RA 003 023-021	21.026-091	2ST 001 259-321
				70 693	2PS 004 361-001	21.026-131	2SB 001 259-261
				70 693	2PS 004 361-007	21.028-061	2SW 003 014-131
				75 069	2SB 001 240-311	21.028-071	2SD 003 014-151
				97 819	9EL 092 435-011	21.037-001	2ST 001 673-011
						21.037-021	2SB 001 673-002
						21.038-041	2SE 001 301-021
						21.044-001	2SB 001 679-051
						21.044-011	2SD 001 679-001
						21.086-021	2SE 003 167-031
						21.086-031	2SD 003 167-021
						21.086-041	2SE 003 167-041
						21.086-051	2SD 003 167-011
						21.111-001	2SD 003 184-031
						21.111-001	2SE 997 111-011
						21.111-011	2SE 997 111-021
						21.113-001	2VA 997 113-001
						21.131-001	2SD 997 131-051
						21.147-001	2SK 003 567-331
						21.147-001	2SK 003 567-651
						21.147-011	2SK 003 567-321
						21.147-011	2SK 003 567-661
						21.147-021	2SL 003 567-311
						21.147-061	2VP 003 567-111
						21.147-071	2VP 003 567-121
						21.167-001	2SE 007 547-011
						21.167-001	2SE 007 547-021
						21.167-011	2SE 007 547-021
						21.167-031	2SE 007 547-041
						21.167-031	2SL 007 547-061
						21.167-051	2SL 007 547-067
						21.176-001	2SL 005 883-031
						21.176-011	2SK 005 883-021
						21.176-021	2SK 005 883-011
						21.176-031	2SL 005 883-041
						21.197-001	2VP 007 323-011
						21.197-011	2VP 007 323-021
						21.197-021	2VD 007 323-031
						21.197-031	2VD 007 323-041
						21.197-101	2VP 007 323-111
						21.197-111	2VP 007 323-121
						21.197-121	2VD 007 323-131
						21.197-131	2VD 007 323-141
						22.003-021	2BE 002 582-031
						22.006-181	2BE 997 006-101
						22.007-101	2BE 003 182-091
						22.007-111	2BE 003 182-101
						22.026-071	2BE 001 259-061
						22.028-091	2BE 003 014-251
						22.111-001	2BE 003 184-051
						22.111-011	2BE 003 184-061
						22.131-011	2NE 003 315-011
						23.030-051	2NE 997 131-081
						23.033-001	2NE 001 423-011
						23.056-011	2NE 002 985-001
						24.027-201	2ZR 002 694-001
						24.028-001	2ZR 003 014-091
						24.029-001	2ZR 001 240-351
						24.030-051	2ZR 003 315-041
						24.033-001	2ZR 001 423-001
						24.033-031	1G4 997 033-011
						24.056-001	2ZR 002 985-081
						24.056-011	2ZR 002 985-261
						25.087-001	2KA 003 389-061
						25.011-001	2KA 001 389-101
						25.011-011	2KA 997 011-001
						25.011-011	2KA 997 011-011
						25.011-021	2KA 001 389-101
						25.011-021	2KA 997 011-021
						25.012-011	2KA 001 386-281
						25.012-051	2KA 001 386-281
						25.012-071	2KA 001 386-231
						25.087-161	2KA 998 523-001
						25.122-001	2KA 997 122-001
						26.027-091	2JA 997 027-051
						80.085-001	8HG 002 240-001
						80.085-081	8HG 002 240-021
						80.089-001	8RA 002 020-001
						80.089-001	8RA 003 326-001



Manufacturer's no. / HELLA no.

Cross-Reference

SAW	HELLA	Scania	HELLA	Scania	HELLA	Scania	HELLA
80.091-011	8RA 003 326-021	1 866 834	2PF 959 590-207	20 223 860	9EL 147 096-031	478 346	2SA 001 259-751
80.091-021	8RA 003 326-011	1 866 878	2PS 964 295-051	20 223 861	2SE 007 547-021	478 346	2SA 001 259-757
80.106-001	8RA 004 412-021	1 866 878	2PS 964 295-057	20 223 861	2SE 007 547-027	478 349	2PG 962 964-051
80.106-011	8RA 004 412-011	1 870 722	1K0 008 191-021	20 223 862	2KA 003 389-001	478 349	2PG 962 964-057
80.106-021	8RA 004 412-001	1 870 722	1K0 008 191-027	20 223 863	2PF 001 259-631	478 349	2PS 962 964-012
80.141-001	8RA 002 016-111	1 870 733	1BL 008 193-011	20 223 864	2PF 003 057-001	478 349	2PS 962 964-018
80.141-011	8RA 002 016-101	1 871 444	8RA 002 016-111	20 223 865	2SA 001 259-751	484 769	2SA 962 964-091
80.143-001	8RA 002 023-001	1 936 427	2SD 344 200-001	20 223 866	2SA 001 259-757	484 770	2PF 962 964-071
80.143-011	8RA 002 023-011	177 942	8JA 001 914-011	20 223 869	8JD 008 151-041	484 771	2BA 001 221-031
80.143-021	8RA 002 023-021	197 819	9EL 092 435-011	20 223 870	2SD 001 686-101	484 772	2BA 001 221-041
90.001-011	9EL 109 139-001	2 022 3030	2TJ 001 633-211	20 223 879	2ZR 001 423-001	487 70	2PF 962 964-071
90.002-011	9EL 092 435-011	2 022 3241	2RL 007 900-241	20 223 880	9EL 862 141-001	488 421	2KA 001 378-041
90.003-001	9EL 116 844-001	2 022 3756	2XD 010 311-001	20 223 881	2DA 001 423-077	490 896	9GD 963 129-001
90.003-011	9EL 112 741-001	2 022 398 0	9XD 857 445-801	20 223 882	1GA 996 083-011	492 205	2KA 001 378-041
90.003-021	9EL 112 744-001	2 022 398 2	1FE 006 300-001	20 223 883	1GA 006 991-031	561 225	2PG 002 727-021
90.003-051	9EL 112 743-001	2 022 399 8	1BL 008 194-027	20 223 884	1GA 007 506-011	583 086	2JA 004 531-011
90.003-061	9EL 997 310-001	2 300 515	2PT 009 599-131	20 223 884	1GA 007 506-012	618 860	2ZR 001 240-351
90.007-001	9EL 134 739-001	2 300 518	2PT 009 599-141	20 223 886	1GA 007 506-081	619 241	2KA 001 386-281
90.007-011	9EL 137 308-001	20 011 000	2XW 003 146-001	20 223 887	8GJ 002 525-131	629 515	2SA 001 240-331
90.007-081	9EL 118 613-001	20 011 000	2XW 007 146-001	20 223 887	8GJ 002 525-136	633 415	8JA 001 909-001
90.007-091	9EL 118 614-011	20 011 005	2XW 002 897-051	20 223 889	2XA 959 790-411	639 096	9EL 113 928-001
90.007-101	9EL 118 614-021	20 044 850	2ZR 003 236-051	20 223 891	2BA 008 260-001	639 267	9EL 108 651-001
90.007-111	9EL 137 307-001	20 044 850	2ZR 003 236-057	20 223 891	2BA 008 260-007	656 187	8RA 002 023-021
90.007-121	9EL 134 740-001	20 044 855	2NE 003 236-001	20 223 893	2BA 002 324-001	663 046	2SA 001 638-021
90.008-061	9EL 997 332-001	20 044 855	2NE 003 236-008	20 223 894	1AA 127 473-015	675 069	2SB 001 240-311
90.008-101	9EL 146 891-001	20 044 864	2PS 006 717-031	20 223 896	2KA 003 389-211	692 470	2JA 001 330-001
90.010-051	9EL 113 324-001	20 044 864	2PS 006 717-037	20 223 896	2KA 003 389-217	692 470	2JA 001 330-007
90.012-031	9BG 101 230-001	20 223 006	2TM 008 645-951	20 223 897	1F8 007 560-211		Schaeff
90.014-021	9EL 110 013-001	20 223 006	2TM 008 645-957	20 223 907	2RL 007 900-211		HELLA
90.014-031	9EL 110 014-001	20 223 012	2XL 004 762-001	20 223 900	9EL 950 315-031		1G3 996 001-271
90.015-001	9EL 116 907-001	20 223 014	2RL 010 979-001	20 223 911	2PG 962 964-041		2VP 006 040-111
90.015-011	9EL 116 907-001	20 223 032	9EL 950 315-061	20 223 913	2PS 003 748-161		2VP 006 040-117
90.017-001	9EL 117 330-001	20 223 034	8GD 002 078-241	20 223 913	2PS 003 748-167		1G3 003 710-021
90.017-021	9EL 117 330-011	20 223 037	2PF 003 389-037	20 223 914	2XS 003 748-161		1GA 006 991-041
90.017-081	9EL 117 334-001	20 223 038	2XS 008 078-001	20 223 915	2XS 955 031-001		1GA 007 506-011
90.017-091	9EL 117 334-021	20 223 038	1GA 996 288-001	20 223 915	2PS 008 616-011		1GA 007 506-012
90.019-041	9EL 108 435-001	20 223 053	2PT 009 599-131	20 223 915	2PS 008 616-017		
90.026-001	9EL 135 286-001	20 223 131	2PT 009 599-141	20 223 920	2RL 008 061-111		
90.026-021	9EL 109 208-011	20 223 141	2PT 009 599-141	20 223 922	1F8 007 560-311		
90.026-041	9EL 088 150-001	20 223 150	2RL 011 484-001	20 223 925	2BA 007 135-001		
90.026-091	9EL 088 538-001	20 223 198	2BA 009 204-051	20 223 929	9XX 340 220-011		
90.027-291	9EL 113 928-001	20 223 198	2BA 009 204-057	20 223 930	1F8 158 926-011		
90.028-111	9EL 110 540-001	20 223 205	1F8 007 560-201	20 223 933	2SL 003 567-311		
90.028-121	9EL 110 542-001	20 223 450	2ZR 005 860-151	20 223 938	9XX 340 220-001		
90.028-141	9EL 110 536-011	20 223 483	9DW 196 483-001	20 223 943	2SK 003 567-651		
90.028-151	9EL 110 536-001	20 223 500	2ZR 997 506-391	20 223 944	8KA 950 073-001		
90.028-171	9EL 115 003-011	20 223 550	2ZR 005 700-191	20 223 946	9GH 993 984-001		
90.028-181	9EL 115 003-035	20 223 560	9EL 183 432-001	20 223 950	1F8 006 800-221		
90.028-201	9EL 115 003-055	20 223 566	2RL 010 710-741	20 223 951	1F8 006 800-321		
90.028-211	9EL 110 544-001	20 223 577	2VP 008 789-021	20 223 969	9EL 147 747-001		
90.030-061	9EL 119 977-001	20 223 579	2PS 008 645-001	20 223 970	2SK 003 567-661		
90.044-011	9EL 126 294-001	20 223 579	2PS 008 645-007	20 223 971	2RL 008 181-111		
90.087-001	9BG 121 587-031	20 223 582	2VP 340 940-101	20 223 974	2SD 003 167-021		
90.088-001	9EL 997 441-001	20 223 583	2VP 340 940-111	20 223 976	2RL 007 552-011		
90.111-001	9EL 118 700-001	20 223 587	2BE 002 582-031	20 223 981	2PS 008 643-021		
90.111-001	9EL 997 451-001	20 223 597	2RL 010 710-131	20 223 981	2PS 008 643-027		
90.111-011	9EL 997 452-001	20 223 599	2SD 344 200-001	20 223 985	9EL 134 296-041		
90.111-021	9EL 118 703-001	20 223 603	2PG 003 748-151	20 223 991	8GS 007 949-261		
90.111-031	9EL 118 705-001	20 223 604	2VD 008 204-071	20 223 992	1K0 008 191-041		
90.113-001	9EL 997 453-001	20 223 610	2SA 006 717-001	20 223 992	1K0 008 191-047		
90.131-001	9EL 997 459-001	20 223 610	2SA 006 717-007	20 223 997	8GH 007 157-241		
90.131-081	9EL 997 469-001	20 223 611	2TM 003 748-011	20 223 997	5DV 007 810-171		
90.147-001	9EL 122 772-001	20 223 631	2RL 007 900-631	202 237 48	2RL 008 183-111		
90.147-021	9EL 122 689-021	20 223 656	1FE 008 773-041	2022 3013	8KW 744 808-801		
90.167-001	9EL 147 096-001	20 223 751	1F8 007 560-451	20223011	1F8 161 326-011		
90.167-011	9EL 147 097-001	20 223 753	2VP 003 567-121	20223813	2XD 009 051-011		
90.176-001	9EL 135 548-001	20 223 753	2VP 003 567-127	20223813	2PS 008 643-031		
90.196-001	9EL 141 135-031	20 223 754	9EL 122 689-021	20223934	2PS 008 643-037		
90.196-011	9EL 141 135-021	20 223 791	2NE 001 423-011	20223934	2JA 007 372-041		
90.197-001	9EL 146 887-001	20 223 792	2XS 007 841-021	20223979	2RL 007 900-611		
92.147-001	9BG 130 945-001	20 223 793	2BM 008 355-001	217 247	9GD 102 484-001		
92.147-011	9BG 130 946-001	20 223 793	2BM 008 355-007	218 412	2AB 001 208-001		
93.115-111	1GA 998 524-001	20 223 797	2SK 003 567-321	225 552	2ZR 001 423-001		
93.190-001	1GA 998 525-001	20 223 798	9EL 150 966-001	233 203	2PS 002 727-001		
		20 223 799	1F8 007 560-321	241 227	2SE 001 685-221		
		20 223 801	9GH 152 654-007	241 227	8G0538		
		20 223 804	1BL 158 060-021	243 219	2SE 001 688-151		
		20 223 807	8JD 008 151-011	243 220	2SE 001 688-161		
		20 223 810	2XS 008 479-051	245 593	9EL 113 324-001		
		20 223 810	2XS 008 479-057	249 111	9ES 106 588-001		
		20 223 812	9XR 855 975-001	257 933	2KA 001 378-041		
		20 223 814	2RL 007 337-031	286 577	2JA 003 231-001		
		20 223 815	1G4 003 470-031	303 223	2KA 001 386-281		
		20 223 824	2SD 001 685-211	303 729	2SA 003 014-051		
		20 223 824	2SD 001 685-218	356 823	2JA 002 661-001		
		20 223 825	1F8 007 560-051	356 824	9EL 116 607-005		
		20 223 827	1F8 007 560-131	357 947	2BA 003 022-021		
		20 223 828	9GD 856 863-001	370 693	2PS 004 361-001		
		20 223 830	2RL 007 337-011	370 694	2PS 004 361-007		
		20 223 831	2XS 950 071-031	370 694	2PG 004 361-011		
		20 223 832	2XS 955 232-001	383 055	2PG 004 361-017		
		20 223 833	2XS 005 020-011	405 235	8JA 003 526-001		
		20 223 834	9EL 950 315-001	406 961	2KA 001 622-001		
		20 223 835	2KA 003 389-061	410 663	2SA 003 057-021		
		20 223 835	2KA 003 389-062	414 129	2ZR 001 193-011		
		20 223 835	2KA 003 389-068	415 320	2ZR 002 694-001		
		20 223 836	2KA 001 386-281	415 761	2KA 001 610-001		
		20 223 837	2PS 004 361-001	419 888	2XD 003 022-061		
		20 223 837	2PS 004 361-007	419 888	2KA 003 389-061		
		20 223 838	2PS 003 748-121	419 888	2KA 003 389-062		
		20 223 838	2PS 003 748-127	427 751	2KA 003 389-068		
		20 223 839	9EL 122 772-001	433 408	8XS 113 389-001		
		20 223 840	2PS 006 717-031	433 568	2ZR 001 240-351		
		20 223 840	2PS 006 717-037	440 354	9EL 113 639-021		
		20 223 841	9EL 141 135-031	451 756	8RA 003 734-101		
		20 223 842	9EL 114 401-001	451 757	2SA 003 734-121		
		20 223 848	8KW 701 235-033	453 090	2DA 003 734-011		
		20 223 851	2XS 005 020-001	474 408	8XS 113 389-001		

Manufacturer's no. / HELLA no.

Cross-Reference



Schmitz Cargobull	HELLA	Schmitz Cargobull	HELLA	Schmitz Cargobull	HELLA	Schmitz Cargobull	HELLA
060974	2SD 003 184-047	062774	2SK 340 101-001	1092434	8KW 998 602-002	1-FZELEK0167	8GH 002 090-253
060976	2PF 006 717-011	062990	8HG 006 294-051	1093	2SD 003 184-031	1-FZELEK0167	8GH 002 090-258
060977	2PS 006 717-031	063001	2JA 001 335-011	1093	2SD 003 184-037	1-FZELEK0200	1GS 005 760-001
060977	2PS 006 717-037	063002	2JA 003 232-001	1094	2SD 003 184-041	1-FZELEK0211	2NE 001 423-011
060978	2SA 006 717-001	063020	2PS 340 000-011	1094	2SD 003 184-047	1-FZELEK0366	1GB 006 213-101
060978	2SA 006 717-007	063029	9EL 950 315-031	1094480	2XA 959 790-401	1-FZELEK0366	1GB 006 213-107
060982	2PG 006 717-021	063030	9EL 950 315-061	1094480	2XA 959 790-407	1-FZELEK0423	2XS 005 020-067
060982	2PG 006 717-027	063035	9EL 950 315-021	1096708	2ZR 997 506-391	1-FZELEK0432	2PS 003 748-161
060983	2PG 006 717-021	063047	9EL 340 201-001	1100	2PF 003 014-071	1-FZELEK0432	2PS 003 748-167
060983	2PG 006 717-027	063049	9XX 340 220-001	1102	2VP 340 400-151	1-FZELEK0481	1FD 005 700-051
060984	2BM 006 692-011	063050	9XX 340 222-001	1102	2VP 340 400-157	1-FZELEK0496	1GD 003 590-701
060984	2BM 006 692-017	063051	9XX 340 223-001	1103	2VP 340 400-141	1-FZELEK0497	2SD 003 167-021
061137	8KW 701 235-033	063052	2KA 340 118-001	1103	2VP 340 400-147	1-FZELEK0498	2SD 003 167-011
061160	8GD 002 078-241	063102	8J 001 933-031	1106070	9EL 340 203-011	1-FZELEK0501	8GA 002 073-241
061160	8GD 002 078-248	063104	9EL 101 353-001	1106071	9EL 340 203-001	1-FZELEK0501	8GA 002 073-248
061182	2BM 006 692-021	063106	9EL 150 966-001	1107386	2PF 340 825-001	1-INBEMA0009	8HG 002 365-001
061182	2BM 006 692-027	063107	9EL 150 965-001	1109172	9HV 340 812-007	2011	8GP 002 066-121
061224	8HG 006 294-051	063113	1GD 005 700-501	1109504	9XX 340 882-001	2213974	1EA 007 108-011
061297	8GP 002 067-241	063118	1GD 005 700-501	1112421	2PG 008 645-961	2213974	1EA 007 108-017
061301	8GP 002 067-241	063392	2SK 340 101-011	1112421	2PG 008 645-967	2309	2AA 001 204-011
061307	8GM 002 092-121	063602	2XS 008 078-001	1112423	2PS 008 645-187	2407	8JA 003 526-001
061308	8GM 002 091-131	063602	2XS 008 078-007	1112424	2PS 008 645-497	2408	8GA 002 073-121
061309	8GM 002 091-141	063633	8GA 002 073-121	1112426	8KL 340 059-001	2408	8GA 002 073-123
061312	8GM 002 091-251	063633	8GA 002 073-123	1112624	4RD 933 332-061	2502	8GA 002 071-241
061320	8GH 002 090-133	063635	8GA 002 071-131	1115	2BA 003 022-021	2502	8GA 002 071-248
061320	8GH 002 090-136	063635	8GA 002 071-133	1128	2ZR 003 236-051	3253	8GP 003 594-258
061321	8GH 002 090-251	063636	8GM 002 092-121	1128	2ZR 003 236-057	3253	8GP 003 594-258
061321	8GH 002 090-253	063637	8GM 002 091-131	1133920	2VP 340 950-011	3990	8IG 856 010-001
061321	8GH 002 090-258	063686	9EL 340 201-001	1133924	2VP 340 950-021	424753	2XW 003 146-001
061323	8GP 002 068-241	063728	8JE 340 060-001	1133927	2KA 010 278-051	424753	2XW 007 146-001
061325	8GP 002 066-121	063748	2XS 955 031-001	1133932	5DS 009 552-001	444736	1G9 001 523-021
061326	8GP 002 068-121	063834	8GA 002 071-121	1138577	9XX 340 883-001	444737	8XT 002 120-001
061329	8GP 002 095-121	063834	8GA 002 071-123	1144	2SA 003 057-021	444739	1GA 007 506-021
061330	8GP 002 095-241	063857	8JE 340 060-011	1149	8GM 002 091-251	447682	9XS 027 639-001
061341	8GA 002 071-121	063973	2VA 997 113-001	1149223	8XS 340 092-011	5111	1GB 006 213-111
061341	8GA 002 071-123	064 370	2PS 008 616-011	1150	8JA 001 925-001	5111	1GB 006 213-117
061343	8GA 002 071-131	064 370	2PS 008 616-017	1150369	2PF 959 590-202	5112	9BG 993 345-001
061343	8GA 002 071-133	064006	9EL 340 208-001	1150369	2PF 959 590-207	51191	2BA 002 324-011
061348	8GA 002 072-121	064043	2DA 959 071-737	1150382	2PF 959 590-212	5370	8GP 002 095-121
061359	8GP 002 066-241	064168	8KL 340 055-021	1150382	2PF 959 590-217	5529	8GP 002 067-241
061360	8GA 002 072-241	064180	2VD 007 323-031	1150382	2PF 959 590-218	612791	1GA 005 060-001
061360	8GP 002 068-241	064541	9EL 146 838-001	1150384	2PF 959 590-237	612792	9XD 130 261-001
061361	8GA 002 071-241	064726	2NE 003 315-011	1154707	2SD 340 685-051	614299	1GA 007 506-081
061361	8GA 002 071-248	064815	2PG 340 000-121	1154731	2KA 010 278-081	618835	8KL 340 055-021
061361	8GA 002 071-261	064816	2PS 340 000-051	1156	2JA 001 364-001	64143	1G3 996 001-131
061366	8GM 002 091-241	065016	1NE 006 300-051	116060	2JA 004 531-011	65813	8GH 002 089-251
061368	8GA 002 073-241	065121	1G4 997 033-011	116062	2JA 004 531-001	65813	8GH 002 089-253
061368	8GA 002 073-248	066404	2NE 001 423-011	116070	1GA 005 060-041	65813	8GH 002 089-258
061368	8GA 002 073-251	066414	2ZR 001 423-001	116072	1G8 002 340-001	7128	5KG 007 629-011
061374	8GA 002 083-251	066417	2ZR 003 236-051	116081	8GH 002 090-251	7129	5KG 007 629-001
061376	8GA 002 071-271	066417	2ZR 003 236-057	116081	8GH 002 090-253	7226	2AB 004 532-001
061378	8GA 002 071-258	066534	4RD 933 332-061	116081	8GH 002 090-258	7385	9MM 860 255-001
061378	8GA 002 071-258	066602	2TJ 001 633-211	1162840	2XS 011 744-051	740021	2SD 001 685-231
061381	8GJ 002 525-251	066603	2PF 001 648-161	1162842	2XS 011 744-061	740022	2SD 001 685-232
061381	8GJ 002 525-258	066608	2TF 001 259-761	1162907	2VP 340 930-101	740022	2NE 001 423-011
061382	8GH 002 090-251	066611	2PF 001 259-631	116641	9GD 861 531-001	740305	2XS 950 071-031
061382	8GH 002 090-253	066612	2SA 001 259-751	1166881	2ZR 996 188-061	740599	2KA 003 389-061
061382	8GH 002 090-258	066612	2SA 001 259-757	1180234	8KA 340 864-011	740599	2KA 003 389-062
061458	2SD 001 688-141	066616	2XS 950 071-031	1188998	2PS 008 643-011	740599	2KA 003 389-068
061470	9EL 113 324-001	066622	2XS 003 168-081	1188998	2PS 008 643-017	740724	2ZR 001 423-001
061471	8GA 002 071-251	066627	2TM 003 748-011	1196	9EL 852 820-001	75 06 05	9GT 074 132-001
061471	8GA 002 071-258	066634	2PG 003 057-011	1203	8GP 002 066-241	7711	2AA 001 204-001
061591	2XW 002 897-041	066713	2KA 001 386-231	121168	9XX 340 222-001	8-0313852	8HG 006 294-021
061591	2XW 002 897-051	066713	2KA 001 386-281	121245	9XX 340 223-001	8482092	9EL 146 491-001
061601	2PF 003 389-037	0674541	9EL 146 838-001	121251	8JE 340 060-011	887237	2PS 008 645-001
061611	2PF 003 014-071	100	2ZR 001 193-011	121511	2VP 340 930-001	887237	2PS 008 645-007
061625	2XS 005 020-011	1017838	2SE 007 547-011	121512	2VP 340 930-011	910898	9XX 340 220-001
061625	2XS 005 020-017	1017838	2SE 007 547-017	1224191	5DS 009 552-011	917145	2BA 001 236-001
061639	2VD 005 300-551	1017845	2VD 007 547-181	1224333	2DA 959 071-737	933179	1A5 003 178-411
061651	8GP 003 594-251	1020747	8GD 002 078-241	1381	2XS 005 020-011	958006	9EL 340 829-031
061651	8GP 003 594-258	1020747	8GD 002 078-248	1381	2XS 005 020-017	958007	9EL 340 829-021
061662	2SK 005 883-021	1028	8RA 003 326-011	1464	8HG 006 294-021	965242	8KL 340 055-021
061663	2SK 005 883-011	1028	8RA 003 326-017	147478	9GD 859 037-001	980042	9LA 965 400-001
061694	2VP 003 567-111	1031	8GP 002 068-121	147490	8HG 005 436-011	980400	2SE 002 582-071
061695	2VP 003 567-121	1034	8KW 701 235-033	1501	9GD 856 863-001	980400	2TJ 001 633-211
061695	2VP 003 567-127	1034100	8KA 340 859-001	16062	2JA 004 531-001	980400	8GH 002 857-241
061717	2PS 004 361-001	1041	8GP 002 068-241	16070	1GA 005 060-041	980400	9EL 109 139-001
061717	2PS 004 361-007	1042260	2PS 008 645-601	16071	1G5 003 241-081	980400	9EL 114 401-031
061723	2KA 001 386-281	1042260	2PS 008 645-607	16081	8GH 002 090-133	980400	9EL 134 659-001
061724	2PG 004 361-011	1042274	2PF 340 825-001	16081	8GH 002 090-136	980400	9EL 134 660-001
061724	2PG 004 361-017	1042582	9HV 340 812-007	1619	2AB 004 532-051	980400X	9EL 114 401-031
061727	2SE 003 167-031	1043	2BA 003 014-011	1619	2AB 004 532-057	980776	1GA 005 060-041
061803	8HG 002 240-031	1043210	8GS 002 296-111	1748	2KA 001 389-101	980777	9XD 130 261-001
061805	8HG 002 240-001	1043538	2PS 008 645-797	1748	2KA 006 896-001	980902	8GP 002 095-241
061806	8RA 004 412-011	1043539	2PS 008 645-787	1748	2KA 006 896-007	980904	2SE 004 623-001
061807	8RA 003 326-041	1044	2NE 003 236-008	1751	2KA 998 523-001	980904	2SE 004 623-007
061807	8RA 003 326-047	1044	2NE 003 236-008	1751	2KA 998 523-007	980909	2NE 003 315-011
061817	2PS 006 717-061	1044276	2VA 004 887-031	182991	8RA 003 326-011	980910	2ZR 003 315-041
061817	2PS 006 717-067	1044279	2VP 004 887-021	182991	8RA 003 326-017	980924	2JA 003 354-001
061866	8GM 002 091-241	1044787	2PS 008 645-621	183100	9EL 132 215-001	980950	



Manufacturer's no. / HELLA no.

Cross-Reference

Schmitz Cargobull	HELLA	Sisu	HELLA	Solaris Bus	HELLA	Sommer Aufliieger	HELLA
ELO007-0067	2KA 340 828-001	187-251-1510	9EL 115 830-001	168696	1AL 009 998-041	7428080001	2TM 008 645-931
ELO007-0084	2VP 340 450-451	187-251-1900	9EL 856 418-001	171707	1NO 009 295-057	7428080001	2TM 008 645-937
ELO007-0085	2VP 340 450-441	187-251-2250	9EL 862 141-001	171708	1NO 009 295-067	7828309001	2DA 343 106-201
ELO007-0102	9EL 950 315-061	187-301-0310	9GD 856 863-001	172689	2PT 009 599-131	7828309001	2DA 343 106-207
ELO007-0103	9EL 950 315-031	187-301-0187	2SD 001 685-231	2003-021-035	2PT 009 599-141	Spitzer Aufliieger HELLA	
ELO007-0111	2VP 340 450-021	187-301-0187	2SD 001 685-232	2003-021-035	2PS 964 295-051	50201-00538	2BM 006 692-011
ELO007-0112	2VP 340 450-031	187-301-0277	2SE 001 685-227	200794	2PS 964 295-057	50201-00538	2BM 006 692-017
ELO009-0001	9XX 340 220-001	187-301-0287	2SD 001 685-231	2615-210-020	1AL 009 997-041	50201-00544	8HG 006 294-021
ELO009-0002	9XX 340 222-001	187-301-0537	2SD 001 685-232	2615-210-020	8GP 003 594-251	50201-00560	2SK 003 567-331
ELO009-0003	9XX 340 223-001	187-301-0537	2KA 003 389-211	2615-210-045	8GP 002 067-241	50201-00561	2SK 003 567-321
ELO009-0038	8JE 340 165-001	187-301-0917	2KA 003 389-212	2615-212-030	8GA 002 071-241	50201-05154	2XW 002 897-051
ELO009-0040	9XX 340 879-001	187-301-0917	2PF 001 647-031	262100	8GA 002 071-248	50201-08833	2X5 955 260-001
ELO009-0041	9XX 340 880-001	187-301-1151	2PF 001 647-037	3400-001-935	1KO 008 192-027	50201-08833	2X5 955 260-007
ELO009-0042	9XX 340 870-007	187-301-0287	2VP 007 323-121	3400-001-935	1KO 008 191-021	50201-15672	1GA 007 506-011
ELO009-0043	9XX 340 871-007	187-305-0357	2SA 961 167-011	3400-002-383	1KO 008 191-027	50201-15672	1GA 007 506-012
ELO009-0045	9XX 340 884-001	187-351-0600	9EL 113 324-001	55032	9XB 152 977-001	50201-32503	2X5 955 232-001
ELO009-0046	9XX 340 881-001	187-401-0117	9EL 122 689-001	55038	2BA 009 001-511	50201-33723	2RL 006 846-011
ELO010-0016	8KL 340 050-001	187-401-0117	2JA 001 330-001	55811	5DS 009 602-001	50201-33724	8HG 006 294-011
ELO010-0019	8KL 340 039-001	187-401-0117	2JA 001 370-011	55811	1NO 008 582-011	50202-00542	8GA 002 071-241
ELO012-0014	8KA 340 031-001	187-408-0017	2AB 001 208-001	55828	1NO 008 582-017	50202-00542	8GA 002 071-248
ELO012-0065	8KA 340 843-011	187-408-0021	2AB 004 532-051	55841	2BA 009 001-167	50202-00634	8GH 002 090-251
ELO012-0067	8KA 340 843-021	187-408-0021	2AB 004 532-057	55862	2PF 340 825-001	50202-00634	8GH 002 090-253
ELO012-0068	8KA 340 818-021	187-408-0031	2JA 004 192-001	67041	9XX 340 879-001	50202-00634	8GH 002 090-258
ELO012-0069	8KA 340 842-011	187-801-1661	2AA 001 200-151	74991	1N4 007 893-821	50202-15598	8GM 002 092-241
ELO012-0074	8KA 340 815-011	187-801-1671	2AA 001 200-041	88536	2BA 009 001-531	50203-00563	8RA 002 020-002
ELO012-0075	8KA 340 815-021	187-908-0011	9XB 152 977-001	92744	2JA 343 660-117	50203-00563	8RA 002 020-002
ELO012-0077	8KA 340 815-001			93466	2AB 004 532-011	ET 62520	6ED 004 778-011
ELO012-0083	8KA 340 819-001			94974	1F4 007 893-081	ET 62710	9EL 122 772-001
ELO013-0005	8GP 002 068-241				2XS 011 768-021	ET 62717	9EL 964 289-001
ELO013-0006	8GD 002 078-241					ET 62718	9EL 964 290-001
ELO013-0006	8GD 002 078-248					ET 62719	8RA 964 292-001
ELO014-0003	8JE 340 060-001					ET 63000	8RA 003 326-011
ELO014-0048	8JE 340 060-251					ET 63000	8RA 003 326-017
HWZ300-0047	8PE 008 932-001					ET 63000	2AA 001 200-131
K076000132	2PS 008 643-007					ET 63000	2PF 003 014-071
S060561	2SK 003 567-321					ET 63000	8GA 002 071-241
S060562	2SK 003 567-331					ET 63000	8GA 002 071-248
S060827	2KA 003 389-061					ET 63000	8GA 002 071-251
S060827	2KA 003 389-062					ET 63000	8GA 002 071-258
S060827	2KA 003 389-068					ET 63000	8GM 002 092-241
S060870	8RA 004 412-001					ET 63000	2BM 006 692-011
S061361	8GA 002 071-241					ET 63000	2BM 006 692-017
S061361	8GA 002 071-248					ET 63000	2BM 006 692-021
S061806	8RA 004 412-011					ET 63000	2BM 006 692-027
Seat	HELLA					ET 63000	2KA 001 386-231
1J0 955 964 F	9GS 146 999-727					ET 63000	8GA 002 073-241
Sisu	HELLA					ET 63000	8GA 002 073-248
181-030-1211	6NM 007 282-221					ET 63000	8RA 002 020-001
183-520-0151	5DV 007 810-171					ET 63000	8RA 002 020-002
186-510-0781	8KA 152 134-007					ET 63000	2SK 003 567-321
186-510-0791	8JD 156 150-807					ET 63000	2SK 003 567-331
186-510-0801	8JD 156 151-807					ET 63000	2X5 955 260-001
186-520-0013	8JB 004 777-001					ET 63000	2X5 955 260-007
186-520-0013	8JB 004 777-002					ET 63000	8RA 003 326-051
186-911-5410	8JA 003 526-001					ET 63000	2NE 001 423-011
187 106 0167	1GA 007 506-081					ET 63000	2ZR 001 423-001
187 130 0271	1A6 002 395-071					ET 63000	2ZR 003 236-051
187 130 0271	1A6 002 395-077					ET 63000	2ZR 003 236-057
187-003-0311	8GH 002 857-241					ET 63000	2KA 003 389-001
187-009-0381	8GS 007 949-261					ET 63000	2SD 001 685-211
187-101-2637	1FE 006 300-041					ET 63000	2SD 001 685-218
187-101-2637	1FE 006 300-081					ET 63000	1GA 003 470-031
187-101-2667	1F8 006 800-221					ET 63000	2XW 002 897-051
187-101-2677	1F8 007 560-011					ET 63000	
187-101-3127	1EA 007 108-021					ET 63000	
187-101-3127	1EA 007 108-027					ET 63000	
187-101-3137	1EA 007 108-011					ET 63000	
187-101-3137	1EA 007 108-017					ET 63000	
187-101-3431	1BL 008 193-011					ET 63000	
187-101-3431	1BL 008 193-017					ET 63000	
187-101-3441	1KO 008 191-021					ET 63000	
187-101-3441	1KO 008 191-027					ET 63000	
187-101-3451	1KO 008 192-027					ET 63000	
187-101-3461	1BL 008 194-027					ET 63000	
187-108-0217	1NE 006 300-051					ET 63000	
187-108-0241	1NL 007 186-047					ET 63000	
187-108-047	1NL 007 186-047					ET 63000	
187-130-0221	1A6 002 395-071					ET 63000	
187-130-0221	1A6 002 395-077					ET 63000	
187-130-0461	1KO 158 059-061					ET 63000	
187-130-0471	1BL 158 060-021					ET 63000	
187-181-0440	9GH 152 654-007					ET 63000	
187-181-5820	9GT 143 133-007					ET 63000	
187-191-0000	8JA 001 909-001					ET 63000	
187-191-0000	8JA 001 909-011					ET 63000	
187-201-0615	2BA 001 221-041					ET 63000	
187-201-0616	2BA 001 221-031					ET 63000	
187-201-0647	2BA 002 652-101					ET 63000	
187-201-0647	2BA 002 652-107					ET 63000	
187-201-1427	2BE 003 014-251					ET 63000	
187-201-1427	2BE 003 014-257					ET 63000	
187-201-1617	2PF 001 648-161					ET 63000	
187-201-2127	2BM 002 847-021					ET 63000	
187-201-2137	2BM 002 847-011					ET 63000	
187-201-2337	2PS 004 361-001					ET 63000	
187-201-2337	2PS 004 361-007					ET 63000	
187-201-2537	2XS 955 031-001					ET 63000	
187-201-2557	2PF 961 167-021					ET 63000	
187-201-2597	2TM 004 361-021					ET 63000	
187-201-2611	2PF 008 221-011					ET 63000	
187-201-2611	2PF 008 221-017					ET 63000	
187-201-2627	2BA 008 805-051					ET 63000	
187-201-2627	2BA 008 805-057					ET 63000	
187-201-2637	2PG 964 295-111					ET 63000	
187-201-2637	2PG 964 295-117					ET 63000	
187-201-2657	2BA 008 221-001					ET 63000	
187-201-2657	2BA 008 221-007					ET 63000	
187-206-0072	2RL 008 061-111					ET 63000	
187-206-0156	2BA 003 022-021					ET 63000	
187-206-0221	2RL 008 181-111					ET 63000	
187-207-0011	2XW 003 146-001					ET 63000	
187-251-0910	9EL 110 014-001					ET 63000	
187-251-0911	9EL 110 013-001					ET 63000	
187-251-1210	9EL 115 003-051					ET 63000	
187-251-1300	9EL 108 435-001					ET 63000	
187-251-1510	9EL 115 830-001					ET 63000	
187-251-1900	9EL 856 418-001					ET 63000	
187-251-2250	9EL 862 141-001					ET 63000	
187-281-0310	9GD 856 863-001					ET 63000	
187-30							

Manufacturer's no. / HELLA no.

Cross-Reference



Steinbock	HELLA	Steyr	HELLA	Steyr	HELLA	Still	HELLA
000 36554	2JA 004 531-011	161.25.72.0701	9EL 855 097-001	8.125.26.060.62	2XS 005 020-017	0159673	1A3 002 850-031
00004920	9FF 090 500-001	189.73.0029	2BE 003 185-031	8.125.26.060.62	2XS 005 020-041	0159678	2BA 008 221-001
002 50761	9EL 854 912-001	2.243.72.808.9	2KA 003 389-081	8.125.26.060.62	2XS 005 020-047	0163728	2BA 008 221-007
014 397	2KA 001 389-101	2.812.51.036.01.2	2ZR 001 423-001	8.125.43.508.88	8JA 003 526-001	0163733	9EL 136 819-031
022 505	1TA 003 570-001	2.812.54.350.88.81	8JA 003 526-001	8.166.80.460.12	2XW 003 146-001	0170551	9EL 136 825-011
023 902	2BA 002 652-101	2.852.51.036.00.3	1H3 002 456-012	8.166.80.460.17	2XW 002 897-051	0170552	2SB 001 673-021
023 902	2BA 002 652-107	2904 951 M91	2JA 001 360-001	8.525.10.360.01	1GA 006 876-001	0174907	1TA 003 570-101
026 821	2SE 002 578-701	2924 342 M91	2ZR 001 240-351	8.542.95.010.01	8HG 002 240-031	0174907	1GA 007 506-001
026 821	2SE 002 578-707	2928 454 M1	2BA 001 248-001	81.25160.601.5	2PF 001 647-031	0174907	1GA 007 506-002
026 822	2ZR 003 030-171	2949 833 M91	2BA 002 324-011	8.910.25.060.56	2PF 001 647-037	040865	1GA 007 506-007
032 588	2SD 002 776-241	2949 834 M91	2BA 002 324-021	93.72.0011	8JA 003 526-001	040873	2BA 001 227-201
032 588	2SD 002 776-247	2951 380 M91	2PF 001 634-101	990.00.72.0706	2ZR 002 985-081	040881	2BE 003 018-011
032 869	2NE 003 030-151	2954 497 M91	2BA 002 324-001	AD43-13776-BA	9DF 112 246-001	040882	2BA 001 386-281
040 865	2KA 001 227-201	3.450.19.4	8HG 006 294-041	SFT 7161855050	2XT 009 098-001	040882	2BA 001 259-611
040 881	2KA 001 386-281	3061 399 M8	2BE 003 018-011	X 842 070 990 013	2KA 001 610-001	040904	2BA 001 259-618
044 50800	9EL 856 010-001	3062 196 M8	9EL 887 769-001	X 842 070 990 017	2TJ 001 633-211	040906	8GM 002 091-131
045 44058	8RA 003 326-001	3062 228 M8	2BE 001 278-011	X 842 070 990 031	2SA 001 634-121	040906	8GP 002 067-121
045 44058	8RA 003 326-002	3062 228 M8	2BE 001 278-021	X 842 070 990 031	2BA 002 324-001	040906	8GP 002 067-123
045 44074	2SE 004 623-001	3065 113 M8	2SB 003 018-031	X 860 533 935 209	2BA 001 248-001	401258	2SB 001 673-002
045 44074	2SE 004 623-007	3075 726 M91	2SA 001 634-121	X 860 533 935 719	2BA 002 324-011	0500152	8GM 002 092-121
047 39236	2RL 006 846-011	3093000M91	2BE 001 259-061	X 860 535 935 720	2BA 002 324-021	0528877	2JA 003 720-021
047 39244	8HG 006 294-021	34-172-010	1GA 003 470-011	X 860 582 935 311	9GT 074 132-001	0530214	8GA 002 074-241
047 77427	2KA 004 525-001	34-173-010	2BE 003 182-101	X 860 975 910 001	2PF 001 634-101	1000640	9EL 856 010-001
048 94886	1A3 005 760-501	34-173-011	2BE 003 182-091	X 861 019 404 701	9EL 126 294-001	1001303	9EL 146 491-001
048 94886	1A3 005 760-507	34-176-060	2SD 003 182-061	X 861 019 405 490	2SD 001 679-001	1001304	9EL 119 397-001
049 74019	8JB 004 777-001	34-176-060	2SD 003 182-067	X 861 041 060 350	2ST 003 018-061	1001332	9EL 856 418-001
049 74019	8JB 004 777-002	34-176-061	2SD 003 182-051	X 861 041 060 360	2SB 003 018-031	1019001	8GA 002 525-251
050 06227	2SB 003 014-151	34-176-061	2SD 003 182-057	X 880 000 920 645	2BA 001 240-301	1019001	8GP 002 525-258
050 06229	8GM 002 092-241	391.76.0022	2SE 001 679-051	X 880 000 920 649	2SA 001 240-331	1273631915	9EL 136 819-031
050 06233	8GA 002 073-241	395 935 813	2JA 001 360-001	X 880 000 922 260	2SB 001 259-261	1273631916	9EL 136 825-011
050 33597	8HG 003 799-001	470563520	1GA 996 083-011	X 880 000 922 262	2PF 001 259-631	1278250124	2BA 003 022-001
050 33598	2SA 003 057-021	470563530	1GA 996 083-011			139424	9EL 126 294-001
050 35227	1GA 007 506-001	470563550	1GA 996 083-011			158039	8JA 001 921-102
050 35227	1GA 007 506-002	470563570	1GA 996 083-011			161606	8GA 006 841-241
050 35227	1GA 007 506-007	484 820 00 01	2JA 007 373-061			163731	9FF 111 606-021
050 48068	2BA 001 277-021	484 820 01 01	2JA 007 315-041			170031	8GH 007 157-241
050 49404	8GP 002 068-121	5.207.80.212.00.0	8JA 001 909-011			170031	8GH 007 157-248
050 55490	1H3 002 456-012	5.323.84.175.29.0	2RL 008 062-111			400518	2SD 001 693-011
050 71410	8GD 002 078-241	5.323.84.175.31.0	2ZR 003 030-171			400519	9EL 950 315-031
051 12186	2SD 001 679-001	5.360.80.152.00.0	2AA 001 200-031			401307	8GP 002 067-241
079 39863	1GA 005 060-001	5.360.80.152.A.0.0	2AA 001 200-021			401454	2AB 004 532-051
087 24450	8GH 002 090-133	5.360.80.152.A.0.0	2AA 001 200-023			401454	2AB 004 532-057
087 24450	8GH 002 090-136	5.360.80.152.B.0.0	2AA 001 200-001			402128	2BA 001 277-011
088 82927	1GA 132 459-011	5.360.80.152.C.0.0	2AA 001 200-011			406107	1GA 003 470-001
088838352	9EL 990 267-001	5.360.80.152.C.0.0	2AA 001 200-012			406140	2AB 004 532-011
089 28332	9EL 856 010-001	5.373.80.247.01.0	8HG 002 365-001			407288	1G3 005 760-001
089 56800	1A3 002 850-031	5.373.80.248.01.0	1G8 002 340-011			428041	2SB 003 014-151
200 90	2SB 001 259-261	5.806.91.012.00.0	8RA 002 023-011			4478410	2JA 004 192-001
447 4976	1GA 004 480-001	5.899.91.000.06.0	2ZR 003 014-091			500146	8GP 002 066-121
454 4066	2ZR 003 014-091	5.899.91.000.10.0	1A3 002 850-001			500150	8GD 002 078-241
489 4894	8GJ 002 525-251	5.899.91.000.18.0	2ZR 003 236-051			500150	8GD 002 078-248
500 35558	2SD 003 182-051	5.899.91.004.03.0	2ZR 003 236-057			500155	2KA 001 389-101
500 35558	2SD 003 182-057	5.899.91.004.08.0	2BE 002 582-031			500166	2SD 001 679-001
500 35559	2SD 003 182-061	5.899.91.004.08.0	2BA 003 236-021			502647	8JB 001 943-001
500 35559	2SD 003 182-067	5.899.91.008.02.0	2KA 003 236-027			504185	2BA 001 248-001
510 16328	2SD 343 130-227	5.899.91.008.02.0	2KA 001 378-001			505015	8GM 002 091-241
510 17429	1GA 996 361-431	5.899.91.010.02.0	2KA 001 622-001			507501	8GA 002 083-131
51078719	2SD 343 910-017	5.899.91.010.02.0	2SD 002 582-011			510694	8GA 002 083-251
51078719	2SD 343 910-027	5.899.91.010.03.0	2SD 002 582-021			511505	2SA 001 634-121
511 13392	4DM 009 492-001	5.899.91.010.04.0	2SD 002 582-027			513989	8GA 002 073-241
520 21959	2JA 006 447-041	5.899.91.010.04.0	2SD 002 582-027			513989	8GA 002 073-248
520 30617	2AB 004 532-031	5.899.91.010.08.0	2SA 003 236-041			516597	9FF 090 500-001
520 30665	8GP 002 067-241	5.899.91.010.08.0	2SA 003 236-048			518289	8GA 002 071-251
524 112	2ZR 002 985-261	5.899.91.010.09.0	2DA 003 236-031			518289	8GA 002 071-258
525 535	2VP 006 040-111	5.899.91.010.09.0	2DA 003 236-037			518293	8GA 002 073-121
525 535	2VP 006 040-117	5.899.91.010.09.0	2NE 003 236-001			518293	8GA 002 073-123
525 536	2VP 006 040-121	5.899.91.010.10.0	2NE 003 236-008			518819	8HG 002 240-001
525 536	2VP 006 040-127	5.899.91.012.14.0	2RA 003 660-007			519565	2SY 003 014-121
525 681	2VP 006 040-351	5.900.05.800.58.0	2AA 001 200-141			519566	2BA 003 014-011
525 681	2VP 006 040-357	5.900.05.800.87.0	2AA 001 200-151			519699	8GH 002 089-133
525 682	2VP 006 040-307	5.900.05.800.91.0	2AA 001 200-131			519699	8GH 002 089-136
850 06026	8RL 002 009-021	5.920.00.125.71.0	9GH 096 532-001			519845	2SA 003 014-051
987 4533	2SD 003 182-051	6.805.80.119	6ED 004 778-011			520208	2SW 003 014-131
987 4533	2SD 003 182-157	6.920.08.100.03	2SL 003 567-311			520288	2ZR 003 014-091
988 3755	2VP 003 567-111	692.00.72.0701	9EL 854 912-001			520880	2DA 003 014-031
		692.00.72.0740	9EL 856 418-001			521604	2DA 003 014-037
		692.00.81.0701	9EL 856 418-001			521604	8GA 002 071-241
		69200770123	9GT 124 772-001			521726	2JA 001 330-001
		69200810004	9EL 077 132-001			521726	2JA 001 330-007
		69200810005	2SK 003 567-321			521945	2ZR 003 030-171
		7.004.85.004.0	9GP 003 995-801			521996	8GP 002 095-241
		7.111.85.013.0	2BA 002 324-001			522086	8GH 002 089-251
		7.121.93.507.0	2SD 001 686-101			522086	8GH 002 089-258
		7.121.93.529.0	2BA 003 014-011			522579	2BE 003 185-031
		7.141.85.225.9	2KA 004 525-001			522722	8GH 002 090-133
		7.161.85.505.0	2JA 004 531-011			522722	8GH 002 090-136
		7.211.85.539.1	2KA 001 610-001			522980	1GD 003 590-701
		7.534.18.300.00	8HG 096 531-007			522981	8GH 002 090-251
		7.534.18.300.00	2XS 005 020-001			522981	8GH 002 090-258
		7.581.85.001	2XS 005 020-002			523034	8GA 002 071-241
		7.581.85.003.0	2XS 005 020-003			523541	8GA 002 071-248
		7.581.85.003.0	1GA 007 506-011			523541	2BA 002 324-001
		7.581.85.003.0	1GA 007 506-012			523778	9EL 088 150-001
		7.587.85.003.0	2BA 002 652-101			523895	8GM 002 091-251



Manufacturer's no. / HELLA no.

Cross-Reference

Still	HELLA	Still	HELLA	Terex	HELLA	Terex	HELLA
526 208	1TA 003 570-001	95353285	1GA 007 506-012	1678566	8GP 003 594-141	3600933	8GJ 002 525-258
526077	2SE 004 623-001	954445	8GP 002 067-241	1678737	2SD 003 184-031	3600989185	9EL 146 491-001
526078	2SE 004 623-007	9740423	1GA 007 506-001	1678737	2SD 003 184-037	3603754	1GA 006 991-041
526282	2ZR 003 315-041	9740423	1GA 007 506-002	1678964	2SD 003 184-041	3625590	2NE 003 030-151
526363	1G3 005 760-001	9740423	1GA 007 506-007	1678964	2SD 003 184-047	3637367	8GJ 002 525-131
526363	2SD 003 184-031	9740443	1GA 007 506-001	1744761	1GA 005 060-001	3637367	8GJ 002 525-136
526363	2SD 003 184-037	9740443	1GA 007 506-002	1765459	2XS 005 020-011	3649689	9EL 856 416-001
526364	2SD 003 184-041	9740443	1GA 007 506-007	1765459	2XS 005 020-017	3650251	2BA 996 012-061
526364	2SD 003 184-047	9740444	1G3 005 760-221	1777384	2VP 003 567-121	365251	2BA 996 012-061
526365	2ZR 006 609-081	9740444	1G3 005 760-227	1777384	2VP 003 567-127	3665383	1AB 006 213-011
526365	2ZR 006 609-087	9740455	1GA 007 506-391	1813000001	8GP 002 068-121	3665383	1AB 006 213-027
526668	2SD 002 582-011	9740471	1GN 996 361-461	1813000002	8GP 002 067-121	3698768	2SD 001 685-307
526668	2SD 002 582-017	999025	1GD 708 919-001	1813000002	8GP 002 067-123	3708006748	8GA 002 073-241
526669	2SD 002 582-021	999038	1GA 007 506-061	1813000003	8GA 002 072-121	3708006791	8GA 002 073-248
526669	2SD 002 582-027	999039	1GA 007 506-011	1813000004	8GA 002 071-131	3708110535	2ZR 003 014-091
526786	8RA 004 412-021	999040	1GA 007 506-012	1813000004	8GA 002 071-133	3708110535	1EA 993 975-051
526868	2SK 003 567-321	999040	2BA 002 652-101	1813000005	8GA 002 073-121	3749022	1EA 993 975-057
526869	2SK 003 567-331	999040	2BA 002 652-107	1813000005	8GA 002 073-123	3749022	2AA 003 257-041
527169	1G3 005 760-201	999042	8XS 113 389-001	1813000007	8GA 002 083-131	3749022	2AA 003 257-042
527367	8RA 003 326-931	999129	9EL 118 701-001	1813000010	8GA 002 071-121	3927197	2ZR 964 169-107
527446	2JA 003 354-001	SWF	HELLA	1813000010	8GA 002 071-123	3928789	1EA 993 975-011
527885	1GA 007 506-001	300 588	2SD 001 699-061	1813000011	8GA 002 071-251	3928789	1EA 993 975-011
527885	1GA 007 506-002	300 589	2SE 001 699-071	1813000011	8GA 002 071-258	3928790	1EA 993 975-021
527885	1GA 007 506-007	611 004	4RA 965 400-001	1813000016	8GH 002 090-133	3928790	1EA 993 975-027
527975	9GH 993 984-001	Terex	HELLA	1813000016	8GH 002 090-136	3929655	2SD 001 685-277
529489	2SE 998 530-061	00053012	1G4 003 470-141	1813000019	8GA 002 071-121	3963146	2RL 007 337-021
529489	2SE 998 530-067	00053012	1G4 003 470-147	1813000019	8GA 002 071-123	3963146	2RL 008 966-001
529762	2NE 003 315-011	02112312	1GM 996 135-051	1813000021	8GP 002 095-121	3970190	2RL 006 846-001
531429	8XS 113 389-001	02112312	1GA 007 506-431	1813000022	8GJ 002 525-131	3974763	8HG 006 294-041
532456	8GD 002 078-121	02184112	1GA 007 506-431	1813000022	8GJ 002 525-136	3981604	8GH 007 157-121
532472	8GH 007 157-121	0308352	8GA 002 071-121	1813000022	8GP 002 066-241	3981604	8GH 007 157-126
532472	8GH 007 157-126	0308352	2AA 001 200-123	1813000025	8GP 002 067-241	3990058	1EA 990 185-021
534115	2SE 003 184-101	0309762	2GA 001 200-041	1813000026	8GP 002 068-241	3990069	9EL 990 186-001
534454	2SD 343 130-157	0309773	2AA 001 200-131	1813000027	8GA 002 071-241	448555	9EL 111 647-001
534455	2SD 343 130-167	0309784	2AA 001 200-141	1813000028	8GA 002 071-248	448646	8GM 002 092-121
5419492	8GH 002 090-251	0309955	8GP 002 068-121	1813000028	8GA 002 071-131	448920	2KA 001 386-261
5419492	8GH 002 090-253	0313213	2SB 001 301-021	1813000028	8GA 002 071-133	4691694	2JA 003 354-001
5419492	8GH 002 090-258	0313235	8RA 002 020-051	1813000028	8GA 002 071-251	4693641	8HG 006 294-011
608458	1GA 007 506-001	0313279	8GA 002 071-131	1813000028	8GA 002 071-258	4695427	2SE 002 578-701
608458	1GA 007 506-002	0313279	8GA 002 071-133	1813000029	8GA 002 072-241	4695427	2SE 002 578-707
608458	1GA 007 506-007	0335162	1S3 001 117-041	1813000030	8GP 002 095-241	5050022271	2RL 007 337-031
634743	1GA 007 506-431	0335195	2SD 001 679-001	1813000033	8GP 003 594-141	5050022279	2RL 008 060-101
651399	1GM 996 134-081	0335264	2AB 001 208-001	1813000035	8GH 002 090-133	5050022280	2XD 012 160-801
656973	1GM 996 134-081	0335311	8GD 002 078-121	1813000035	8GH 002 090-136	5050022294	2RL 006 846-001
656974	1GM 996 134-081	0335333	8GM 002 091-121	1813000039	8GH 008 357-001	5050022295	2RL 006 846-011
657557	1GM 996 134-081	0335333	8GM 002 091-131	1813000040	8GH 002 090-251	5050022300	2XD 010 311-011
709580	1GM 996 134-071	0335344	8GM 002 091-131	1813000040	8GH 002 090-253	5050093090	8JA 003 526-001
709581	1GM 996 134-071	0335355	8GP 002 068-131	1813000040	8GH 002 090-258	5050247310	4RD 933 332-061
709582	1GM 996 134-071	0335366	8GP 002 066-121	1813000100	8GM 002 092-121	5050286100	8JB 001 943-001
709583	1GM 996 134-071	0335731	9EL 113 324-001	1813000201	8GP 002 066-121	5050590500	2AA 001 200-151
719846	1GM 996 134-081	0337846	2SD 001 685-211	1814000004	8GM 002 091-131	5050590510	2AA 001 200-131
719847	1GM 996 134-081	0337846	2SD 001 685-218	1814000005	8GM 002 091-121	5050590520	2AA 001 200-141
719848	1GM 996 134-081	0341693	2BA 001 227-111	1814000008	8GM 002 092-241	5050590530	2AA 001 200-041
719848	1GM 996 134-081	0341740	2AA 001 200-151	1814000010	8GA 002 072-241	5050590530	8JD 008 151-051
719849	1GM 996 134-081	0350467	8GH 002 089-133	1814000101	8GM 002 092-121	505061209	8JA 003 526-001
7916291272	4RA 965 400-001	0350467	8GH 002 089-136	1814000201	8GP 002 066-121	530658344	8RA 003 326-041
7919052705	2ZR 003 315-041	0353471	8GH 002 089-251	22581012	1GA 007 506-491	5350246805	8RA 003 326-047
7919500941	8GA 002 071-241	0353471	8GH 002 089-253	2260031	1G4 003 470-051	5350246882	8KW 701 235-033
7919500941	8GA 002 071-248	0353472	8GH 002 089-258	2611752	2BA 001 259-611	5350246882	1EA 993 975-091
7919500953	8GP 002 067-121	0353481	8GP 002 068-241	2611752	2BA 001 259-618	5350246882	1EA 993 975-101
7919500953	8GP 002 067-123	0353493	8GP 002 066-241	2622026	9EL 118 701-001	5350246883	1EA 993 975-107
7919500971	8GM 002 092-121	0353506	8GM 002 092-241	2622051	9EL 118 700-001	535024690	1EA 993 975-091
7919518925	8GJ 002 525-131	0355371	8GP 002 095-121	2626179	2BA 002 652-111	535024690	1EA 993 975-097
7919518925	8GJ 002 525-136	0356894	8GA 002 073-241	2626179	2BA 002 652-117	535024691	1EA 993 975-101
7919518926	8GJ 002 525-251	0356894	9EL 126 294-001	2626191	2BA 002 652-121	535024691	1EA 993 975-107
7919518926	8GJ 002 525-258	0363780	9GA 104 328-001	2626191	2BA 002 652-127	535024691	1EA 993 975-107
7919564920	8GA 002 073-121	0377300	8GP 002 067-121	2654651	2JA 003 231-001	5350249809	2KA 003 389-061
7919564920	8GA 002 073-123	0377300	8GP 002 067-123	2655152	8RA 002 016-121	5350249809	2KA 003 389-068
7919564945	8GH 002 090-133	0385753	9AG 104 328-001	2655174	8HG 002 240-031	5350249809	2SB 001 301-021
7919564945	8GH 002 090-136	0388449	2SD 002 514-161	2670719	2SA 001 259-751	5350249809	2ZR 959 820-601
7919564946	8GH 002 090-251	0388449	8XS 113 389-001	2670719	2SA 001 259-757	5350568359	2VP 006 040-111
7919564946	8GH 002 090-253	0388450	8GA 002 073-121	2670719	2JA 001 357-012	5350568359	2VP 006 040-117
7919564946	8GH 002 090-258	0396507	8GA 002 073-123	2670719	1EA 007 108-011	5350568359	2RL 008 060-111
7919564958	8GP 002 067-241	0401969	9EL 119 614-031	2670719	1EA 007 108-017	5350568359	2KA 001 389-101
7919564970	8GM 002 091-251	0401969	8GM 002 067-241	2670719	1EA 007 108-021	5350633350	9EL 118 614-011
7919564982	8GM 002 092-241	0406970	8GM 002 091-241	2670719	1EA 007 108-027	5350633350	1G5 003 241-021
7919564985	8GA 006 841-121	0406972	8GH 002 090-133	2670719	1AA 143 897-011	5350633350	8GH 002 090-133
7919564985	8GA 006 841-123	0406972	8GH 002 090-136	2670719	2PS 004 361-001	5350633350	8GH 002 090-136
7919564997	8GA 002 073-241	0413474	8GA 002 083-251	2670719	2PS 004 361-007	5350633350	9GD 120 670-001
7919564997	8GA 002 073-248	0413601	8GM 002 091-251	2670719	2JA 001 357-002	5350633350	8HG 002 365-001
7919651001	2JA 343 720-111	0413602	8GM 002 091-251	2670719	8GH 002 090-253	5350633350	8HG 006 294-031
7919651010	2AB 004 532-011	0416944	8RA 002 016-121	3000451550	8GH 002 090-258	5350633350	8JB 850 434-011
7919680005	2XS 950 071-031	0417887	8GA 002 071-251	3000451550	8GH 002 090-258	5350633350	9GH 996 532-001
8004902	2JA 007 372-011	0417887	8GA 002 071-258	3000451550	8GH 002 090-258	5350633350	8HG 006 294-021
8007454	8GA 002 073-241	0418457	8GA 002 071-241	3511850601	2SD 001 680-271	5350633350	9GH 993 984-001
8007454	8GA 002 073-248	042					

Manufacturer's no. / HELLA no.

Cross-Reference



Terex	HELLA	Terex	HELLA	Trifa	HELLA	Trifa	HELLA
5350642358	8JB 001 933-031	6026426	2TA 964 169-061	00521-011	8GD 008 898-061	02749-011	8GA 007 997-272
5350650400	2SB 003 014-151	6026426	2TA 964 169-067	00523-011	8GD 002 084-131	02750	8GA 007 997-191
5350650450	2BA 003 014-011	6026428	2BA 964 169-011	00528-011	8GD 002 084-151	02750-011	8GA 007 997-191
5350650470	8RA 003 326-002	6026428	2BA 964 169-017	00529	8GD 008 897-121	02751	8GA 007 997-201
5350650470	8RA 003 326-002	6026429	2DA 964 169-001	00529-011	8GD 008 897-121	02751-011	8GA 007 997-201
5350650490	2SD 006 040-031	6026429	2DA 964 169-007	01102-011	8GP 002 068-241	03381-011	8GD 002 078-121
5350650490	2SD 006 040-037	6029864	1G3 996 001-301	01122-011	8GP 002 067-241	03382-011	8GD 002 078-241
5350650495	2SD 006 040-041	60491840	1G8 002 340-001	01202-011	8GM 002 094-241	03391-011	8GD 004 772-121
5350650500	8RL 002 009-021	6057261	1GA 996 142-011	01204-011	8GM 002 092-241	03391-505	8GD 004 772-123
5350650505	2NE 003 030-151	6081142	1GB 996 080-011	01221-011	8GM 002 091-141	08381-011	8GA 006 841-121
5350654815	1AD 996 018-001	6090079408	8KB 990 299-011	01222-011	8GM 002 091-261	107	8GP 002 066-121
5350654820	1G3 996 001-271	6092414	2JA 003 354-031	01223-011	8GM 002 091-251	109	8GP 002 066-241
5350657810	2X5 005 020-001	6101560M91	1GB 996 080-107	01232-011	8GM 002 091-121	1102	8GP 002 068-241
5350657810	2X5 005 020-002	6131525	2SD 344 100-101	01232-011	8GM 002 091-241	112	8GP 002 068-131
5350657810	2X5 005 020-003	6131526	4DM 009 492-001	01241-011	8GM 002 091-181	1122	8GP 002 067-241
5350657815	2X5 950 071-031	6161265	8RA 003 734-101	01304-011	8GA 002 071-241	11655-011	8GH 002 089-501
5350658332	2SB 009 362-041	6162076	9XD 130 261-001	01305-011	8GA 002 071-251	11658-011	8GH 002 090-481
5350658333	9XD 161 119-007	6174691	2XD 011 557-101	01314-011	8GA 002 071-361	117	8GP 002 068-121
5350658334	2BA 009 001-191	6174692	2XD 011 557-111	01354-011	8GA 002 072-241	120	8GP 002 067-061
5350658342	8RA 003 326-031	7503076	9GH 993 984-001	01381-011	8GA 002 073-241	1202	8GM 002 094-241
5350658343	8RA 003 326-031	7700165	1GA 996 161-121	01391-011	8GA 002 074-241	1204	8GM 002 092-241
5350658344	8RA 003 326-041	7700168	1G0 996 176-131	01425-011	8GA 002 083-251	121	8GP 002 067-121
5350658344	8RA 003 326-047	7700168	1G0 996 176-137	01526-011	8GD 002 084-251	1215	8GM 002 091-251
5350658352	8RA 002 016-111	7700221	1BA 996 261-021	01600	8GA 007 997-101	1221	8GM 002 091-141
5350658355	8RA 004 412-011	8000-1913	2SD 003 182-051	01600-011	8GA 007 997-101	1222	8GM 002 091-261
5350658357	8RA 004 412-011	8000-1913	2SD 003 182-057	01602	8GA 007 997-111	1223	8GM 002 091-251
5350658359	2VP 006 040-111	8000-1914	2SD 003 182-061	01602-011	8GA 007 997-111	1231	8GM 002 091-121
5350658359	2VP 006 040-117	8000-1914	2SD 003 182-067	01607-011	8GH 007 157-121	1232	8GM 002 091-241
5350658360	9EL 136 825-001	8000-2090	2AA 001 200-011	01607-250	8GH 007 157-913	1241	8GM 002 091-181
5350658361	2VP 006 040-121	8000-3286A	9EL 118 614-021	01607-275	8GH 007 157-941	1304	8GA 002 071-241
5350658361	2VP 006 040-127	8000-3287	8BE 003 182-101	01607-293	8GH 007 157-901	1305	8GA 002 071-251
5350658362	9EL 136 825-011	8012700	8HG 006 294-011	01617-011	8GH 007 157-241	1354	8GA 002 072-241
5350658365	9EL 146 491-001	8013964	8GM 007 997-081	01617-251	8GH 007 157-931	1381	8GA 002 073-241
5350658370	2VP 006 040-301	8020551	1G0 996 176-041	01617-51	8GH 007 157-931	1391	8GA 002 074-241
5350658370	2VP 006 040-307	8020850	2BA 009 001-001	01621-011	8GH 005 636-121	1425	8GA 002 083-251
5350658372	2VP 006 040-351	8020850	2BA 009 001-007	01623-011	8GH 005 636-121	150	8GP 002 096-061
5350658372	2VP 006 040-357	8020851	2SB 009 001-061	01640	8GH 002 473-191	1526	8GD 002 084-251
5350658376	2SD 001 685-231	8020851	2SB 009 001-067	01642-011	8GH 007 543-121	1607	8GH 007 157-121
5350658376	2SD 001 685-232	8026410	1GA 996 461-747	01644-011	8GH 008 417-012	1617	8GH 007 157-241
5350658655	2RL 008 060-111	8027148	2XD 010 311-021	01646-011	8GH 002 857-241	1621	8GH 005 636-121
5350658660	1G3 003 710-021	8131027	8GD 002 078-241	01647-011	8GH 005 635-161	1623	8GH 005 635-121
5350658661	9DS 121 707-001	8131027	8GD 002 078-248	01648-011	8GH 005 636-201	1639	8GH 002 473-151
5350658670	1GA 003 470-051	8301299	8GM 002 092-241	01653-011	8GH 002 090-271	1641	8GH 002 473-132
5350658675	1GA 006 991-041	8302995	2ZR 959 820-601	01656-011	8GH 002 089-251	1642	8GH 007 643-121
5350658680	1GA 006 991-051	8303007	8RL 002 009-021	01658-504	8GH 002 090-136	1644	8GH 008 417-012
5350658682	1GA 005 060-041	8303015	1GA 996 142-311	01659-011	8GH 002 090-251	1646	8GH 002 857-241
5350658684	1GA 996 142-011	8303025	2JA 003 236-357	01661-011	8GJ 002 525-131	1656	8GH 002 089-251
5350658686	2RL 008 183-101	8305939	1GA 996 192-001	01661-242	8GJ 002 525-913	1659	8GH 002 090-251
5350658692	2ZR 959 820-601	8801449	2KA 003 389-061	01661-250	8GJ 002 525-913	1702	8GA 007 997-011
5350658701	2BE 002 582-031	8801449	2KA 003 389-062	01661-275	8GJ 002 525-971	1702	8GP 002 095-121
5350659100	2BE 003 014-251	8801449	2KA 003 389-068	01661-504	8GJ 002 525-131	1703	8GP 938 026-001
5350659100	2BE 003 014-257	8801455	8HG 006 294-031	01661-504	8GJ 002 525-136	1704	8GP 002 095-241
5350659125	2SE 002 578-701	8801456	9GH 993 984-001	01662-011	8GJ 002 525-251	1712	8GP 003 594-141
5350659125	2SE 002 578-707	8801464	8RA 003 326-031	01662-251	8GJ 002 525-941	1724	8GP 003 594-241
5350659170	1AB 004 231-001	8801467	9XD 990 298-001	01666-011	8GJ 004 173-121	1732	8GP 003 594-121
5350660900	1AB 003 177-071	D6341724	1GM 996 134-061	01667-011	8GJ 003 133-242	1736	8GP 003 594-251
5350660910	9BG 127 426-001	T100155	8JB 004 777-001	01702-011	8GP 002 095-121	1781	8GA 008 892-002
5350660910	1AB 006 213-011	X0341709	1G9 001 523-021	01703-011	8GP 938 026-001	1791	8GD 008 893-002
5350660910	8GD 002 078-241	Timberjack	HELLA	01704-011	8GP 002 095-241	202	8GM 002 094-121
5350660910	8GD 002 078-248	51210102220	1GA 006 991-041	01705	8GA 007 997-181	204	8GM 002 092-121
5350660912	8GJ 002 525-251	F023711	1GA 006 991-041	01705-011	8GA 007 997-181	21122	8GP 002 067-261
5350660912	8GJ 002 525-258	F024607	1AB 006 213-001	01712-011	8GP 003 594-141	21122-011	8GP 002 067-261
5350660915	1AA 004 109-041	F034891	1GA 998 532-011	01716-011	8GA 008 246-001	21304	8GA 002 071-261
5350660920	1AA 143 897-011	F038788	1GA 007 506-001	01724-011	8GP 003 594-241	21304-011	8GA 002 071-261
5350660922	1EA 007 108-021	F038788	1GA 007 506-002	01725	8GA 008 901-241	21305	8GA 002 071-271
5350660922	1EA 007 108-027	F038788	1GA 007 506-007	01725-011	8GA 008 901-241	21305-011	8GA 002 071-271
5350660923	9EL 113 639-021	F038788	1GA 007 506-011	01732-011	8GP 003 594-121	21381	8GA 002 073-251
5350660924	1EA 007 108-011	F038788	1GA 007 506-012	01734-011	8GP 003 594-251	21381-011	8GA 002 073-251
5350660924	1EA 007 108-017	F038788	1GA 007 506-012	01781-011	8GD 008 892-002	21656-011	8GH 002 089-361
5350660927	9EL 990 186-001	F062785	1GA 998 534-011	01791-011	8GD 008 893-002	21661	8GJ 002 525-301
5350660949	9XR 855 975-001	Toyota	HELLA	02002	8GS 007 949-261	21661-011	8GJ 002 525-301
5350660950	8GH 007 157-121	19883	1N0 008 582-001	02002-11-19-5001	8GS 007 949-261	21662	8GJ 002 525-281
5350660950	8GH 007 157-126	19883	1N0 008 582-007	02004	8GS 007 001-151	21662-011	8GJ 002 525-281
5350660951	1EA 990 185-021	300242	9GH 158 051-007	02004-11-19-5001	8GS 007 001-151	221	8GM 002 091-131
5350661210	1GA 005 060-001	DYX00-99532	1F3 161 825-071	02008	8GH 008 356-121	2706	8GA 007 997-011
5350661215	1GA 007 506-011	DYX00-99535	2SB 009 001-401	02008-011	8GH 008 356-121	2714	8GA 007 997-021
5350661215	1GA 007 506-012	DYX00-99536	2BA 009 001-411	02009	8GH 008 357-001	2719	8GA 007 997-041
5350661216	1GA 995 506-021	DYX00-99537	8JD 156 150-807	02011	8GH 008 358-121	2720	8GP 007 997-061
5350661220	1GB 006 213-101	DYX00-99538	8JD 162 581-802	02011-011	8GH 008 358-121	2721	8GA 007 997-001
5350661220	1GB 006 213-107	DYX00-99654	8GS 007 949-261	02012-011	8GH 008 358-241	2725	8GA 007 997-071
5350661225	1GA 007 506-001	DYX00-99655	8GS 009 028-111	02013-011	8GJ 008 837-121	2726	8GA 007 997-081
5350661225	1GA 007 506-002	DYX00-99656	8JD 156 151-807	02013-011	8GJ 008 837-121	2730	8GA 007 997-051
5350661225	1GA 007 506-007	TD400--19883-00	1N0 008 582-001	02027	8GH 008 991-021	2732	8GA 007 997-091
5350661226	1GA 998 534-491	TD400--19883-00	1N0 008 582-007	02027-011	8GH 008 991-021	2749	8GA 007 997-272
5350661227	1GA 007 506-011	TD400-19883-0000P	1N0 008 582-001	02028	8GH 008 991-031	304	8GA 002 071-121
5350661227	1GA 007 506-012	TD4					

Manufacturer's no. / HELLA no.

Cross-Reference



Volkswagen	HELLA	Volkswagen	HELLA	Volvo	HELLA	Volvo	HELLA
KDWHLO9028	2BA 001 277-021	KDWHLO9590	8GA 002 073-241	1 438 529 1	2VA 343 640-117	2 073 216 8	8JA 003 526-001
KDWHLO9029	2BA 001 277-011	KDWHLO9590	8GA 002 073-248	1 438 529 2	2VP 343 640-081	2 073 752 4	2JA 003 231-001
KDWHLO9031	9EL 852 061-001	KDWHLO9591	8GH 002 089-251	1 438 529 2	2VP 343 640-087	2 076 848 9	2X5 005 020-011
KDWHLO9033	2BA 003 022-021	KDWHLO9591	8GH 002 089-253	1 438 796 5	2VP 343 640-091	2 076 848 9	2X5 005 020-017
KDWHLO9044	8GP 002 068-241	KDWHLO9591	8GH 002 089-258	1 438 796 5	2VP 343 640-097	2 084 700 2	8JB 004 777-001
KDWHLO9045	6ZE 001 759-071	KDWHLO9598	9EL 860 743-001	1 438 796 7	2VA 343 640-207	2 084 700 2	8JB 004 777-002
KDWHLO9046	6ZE 001 759-051	KDWHLO9599	9EL 860 743-011	1 443 210 0	8JB 004 777-001	2 087 712 9	9GD 159 740-007
KDWHLO9050	6ED 004 778-011	KDWHLO9601	9GD 861 531-001	1 443 210 0	8JB 004 777-002	2 088 426 7	1N0 008 582-011
KDWHLO9053	2RL 007 900-001	KDWHLO9611	8GH 002 473-132	1 452 913 7	8HG 006 294-031	2 088 426 7	1N0 008 582-017
KDWHLO9054	9XD 861 995-801	KDWHLO9639	2VA 006 040-291	1 455 469 4	8HG 990 368-001	2 089 175 2	2SA 008 405-011
KDWHLO9057	2RL 007 900-201	KDWHLO9640	2VP 006 040-301	1 455 469 4	8HG 990 368-007	2 089 175 2	2SA 008 405-017
KDWHLO9064	2AB 001 208-001	KDWHLO9640	2VP 006 040-307	1 500 714	9EL 110 013-001	2 089 175 2	2SB 008 405-091
KDWHLO9066	2AA 001 204-011	KDWHLO9654	2RL 007 337-011	1 500 715	9EL 110 014-001	2 093 964 5	2SA 008 405-011
KDWHLO9068	2JA 001 364-001	KDWHLO9659	2JA 001 357-002	1 500 755	9EL 092 435-011	2 093 964 5	2SA 008 405-017
KDWHLO9071	1G5 003 241-021	KDWHLO9667	8JA 001 925-001	1 501 357	9GD 102 484-001	2 097 021 0	2JA 003 354-001
KDWHLO9073	2JA 003 231-001	KDWHLO9674	2BA 002 324-011	1 501 357	2JA 001 360-001	2 107 111 6	9XB 152 977-001
KDWHLO9074	2AB 004 532-001	KDWHLO9675	2BA 002 324-021	1 507 994	2BA 002 324-011	2 107 131 4	5DV 007 810-117
KDWHLO9078	8GA 002 074-121	KDWHLO9681	2JA 001 331-011	1 507 995	2BA 002 324-021	2 107 996 2	1BL 008 193-172
KDWHLO9083	8GM 002 091-131	KDWHLO9683	2RL 008 366-021	1 507 127 2	2PF 008 405-051	2 116 600 9	2XA 959 790-401
KDWHLO9086	2BA 003 022-001	KDWHLO9684	2RL 008 366-031	1 507 127 2	2PF 008 405-057	2 116 600 9	2XA 959 790-407
KDWHLO9087	2JA 003 354-001	KDWHLO9690	9MM 862 358-801	1 507 127 7	2BA 008 221-001	2 128 602 7	2JA 343 720-121
KDWHLO9088	9AR 120 266-001	KSP 941 675	9GH 152 654-007	1 507 127 7	2BA 008 221-007	2 129 903 3	1AL 009 997-041
KDWHLO9089	8GA 002 083-131	KSP 941 751	1BL 008 194-001	1 507 128 0	9XB 161 749-007	2 129 903 3	8JD 156 151-807
KDWHLO9100	8JA 003 526-001	KSP 941 751	1BL 008 194-007	1 507 128 9	1K0 008 191-001	2 129 903 3	8JA 746 184-022
KDWHLO9102	2AA 001 201-011	KSP 941 751 A	1BL 008 193-001	1 507 128 9	1K0 008 191-007	2 138 622 3	8KA 157 425-007
KDWHLO9115	2RL 008 061-001	KSP 941 751 A	1BL 008 193-007	1 509 316	2SE 001 688-151	2 139 121 7	9GH 158 051-007
KDWHLO9116	8HG 854 516-001	KSP 941 781	1K0 008 192-011	1 509 317	2SD 001 688-141	2 146 447 0	1BL 247 042-011
KDWHLO9129	2AA 001 200-041	KSP 941 781	1K0 008 192-017	1 509 317	2SE 001 688-161	2 146 447 0	1BL 247 042-017
KDWHLO9131	8JB 004 777-001	KSP 941 781 A	1K0 008 191-001	1 512 294 0	1BL 247 042-011	2 146 447 3	1K0 247 043-021
KDWHLO9132	8KB 004 777-002	KSP 945 225	1K0 008 191-007	1 512 294 0	1BL 247 042-017	2 146 447 3	1K0 247 043-027
KDWHLO9133	1GA 007 506-011	KSP 945 226	2SD 964 169-411	1 512 294 2	1K0 247 043-021	2 146 470	2SW 003 014-131
KDWHLO9134	8KB 007 506-012	KSP 945 227 A	2SD 964 169-401	1 512 294 2	1K0 247 043-027	2 174 120	2RL 008 060-111
KDWHLO9136	8GH 990 299-001	KSP 945 227 A	2SB 964 169-531	1 520 119 7	ZZR 996 012-111	2 183 430 0	8GP 002 095-121
KDWHLO9139	8GH 002 090-133	KSP 945 351	2SB 964 169-538 A	1 522 338 8	2VP 343 640-267	2 193 480	9EL 118 603-011
KDWHLO9139	8GH 002 090-136	KSP 947 101	2PF 003 563-151	1 522 338 9	2VP 343 640-277	2 230 900	9EL 115 003-001
KDWHLO9139	2SD 001 679-001	KSP 953 351	2XM 004 444-001	1 522 897 2	4DN 009 492-101	2 263 770	2JA 001 330-001
KDWHLO9139	2DA 003 014-031	KSP 953 353 A	2BM 003 553-111	1 565 598	8JA 001 915-001	2 263 770	2JA 001 330-007
KDWHLO9139	2DA 003 014-037	KSP 953 353 A	2BA 964 169-501	1 566 887	ZZR 001 423-001	2 281 010	9GH 096 532-001
KDWHLO9151	2XW 003 146-001	KSP 953 353 A	2BA 964 169-507	1 566 888	9ES 106 588-001	2 283 441	1AE 003 427-021
KDWHLO9157	2PS 962 964-031	N 017 738 2	8GA 002 078-121	1 576 963	2NE 001 423-011	2 289 665	9EL 146 491-001
KDWHLO9157	2PS 962 964-037	N 105 286 01	8GH 006 357-001	1 577 794	2KA 001 386-281	2 290 000	1AB 003 177-071
KDWHLO9161	9EL 855 097-001	N 903 605 01	8GP 938 026-001	1 578 652	9GH 096 532-001	2 800 581	1EA 007 108-011
KDWHLO9172	1GA 996 142-041	N 10320101	8GH 007 157-121	1 587 794	2KA 001 386-281	2 800 581	1EA 007 108-017
KDWHLO9200	8HG 116 741-801	N 10320101	8GH 007 157-126	1 620 476	2SL 005 883-031	2 800 582	1EA 007 108-021
KDWHLO9201	2XS 950 071-031	N 102 564 01	8GA 006 841-121	1 620 477	2SK 005 883-021	2 800 582	1EA 007 108-027
KDWHLO9204	1G8 002 340-011	N 102 564 01	8GA 006 841-123	1 620 478	2SK 005 883-011	2 800 822	1EA 007 108-021
KDWHLO9205	8XT 002 120-001	N0177173	8GP 002 067-241	1 620 479	2SL 005 883-041	2 800 822	2SD 002 776-231
KDWHLO9206	2JA 004 192-001	N0177175	8GP 002 067-241	1 620 480	9EL 135 548-001	2 800 823	2SD 002 776-241
KDWHLO9209	2BA 001 227-201	N10 445 701	8GS 007 949-261	1 622 287 5	2RL 010 979-001	2 800 823	2SD 002 776-247
KDWHLO9210	8GM 002 091-121	N47 82 00 525	2ZR 001 193-011	1 699 837	8GA 002 083-251	2 801 241	2JA 006 447-251
KDWHLO9216	2BA 003 236-021	Z 010 549 TE	2AB 004 532-021	11 018 894	1H3 002 456-012	2 801 243	1GA 006 876-001
KDWHLO9216	2BA 003 236-027	Z 052 531	1BL 005 740-091	11 039 155	2SE 002 578-701	2 801 244	1A5 003 178-411
KDWHLO9217	8JA 001 915-001	Z 052 532	1BL 005 740-101	11 039 155	2SE 002 578-707	2 804 477	2JA 006 487-261
KDWHLO9223	2AA 001 200-131	Z052551007	2PS 008 138-821	11 039 399	2RL 006 846-011	2 804 478	2VP 006 040-111
KDWHLO9224	2AA 001 200-151	Z052551018	2PS 008 138-801	11 039 400	8JB 850 434-011	2 804 478	2VP 006 040-117
KDWHLO9225	2AA 003 257-041	Z052551041	2PS 008 138-811	11 039 553	2SE 002 578-701	2 804 479	2VP 006 040-121
KDWHLO9225	2AA 003 257-042			11 039 553	2SE 002 578-707	2 804 479	2VP 006 040-127
KDWHLO9230	2AA 001 204-001			11 087 193	2JA 003 354-001	2 804 482	1GA 007 506-011
KDWHLO9233	8JA 001 921-102			11 087 194	2BA 001 259-611	2 804 482	1GA 007 506-012
KDWHLO9236	8GM 002 092-121			11 087 194	2BA 001 259-618	2 808 249	1EA 993 975-011
KDWHLO9246	6ED 004 778-001			11 087 505	2SA 001 259-751	2 808 249	1EA 993 975-017
KDWHLO9253	8GM 002 094-121			11 113 094	2SA 001 259-757	2 808 250	1EA 993 975-021
KDWHLO9263	9GD 856 863-001			11 113 094	1BL 007 834-007	2 808 250	1EA 993 975-027
KDWHLO9309	9XR 855 975-001			11 117 172	1KL 007 834-027	2 808 251	1EA 993 975-051
KDWHLO9310	8GH 002 089-133			11 117 172	1BL 008 193-011	2 808 251	1EA 993 975-057
KDWHLO9310	8GH 002 089-136			11 117 172	1BL 008 193-017	2 808 252	1EA 993 975-061
KDWHLO9320	9EL 856 010-001			11 117 173	1K0 008 191-041	2 808 252	1EA 993 975-067
KDWHLO9327	2JA 004 531-001			11 200 915	1K0 008 191-047	2 811 040	9GH 993 988-007
KDWHLO9329	2AB 004 532-021			11 206 183	2JA 006 487-347	2 813 699	4RA 003 530-051
KDWHLO9402	4RA 965 400-001			11 706 496	9GH 993 984-001	2 813 715	8HG 006 294-011
KDWHLO9412	2XM 004 444-001			11 881 088	9GH 116 966-011	2 900 219	9EL 113 639-021
KDWHLO9426	2SA 003 014-051			11 881 088	9BG 993 345-001	2 902 033	1AA 143 897-011
KDWHLO9427	2BA 003 014-011			11 881 088	1EA 993 975-091	2 903 491	9EL 137 308-001
KDWHLO9430	1G4 003 470-031			11 882 263	1EA 993 975-097	2 903 856	9EL 136 825-001
KDWHLO9447	1TA 003 570-101			11 882 263	1EA 993 975-101	2 903 858	9EL 136 825-011
KDWHLO9458	2XS 005 020-001			11 882 263	1EA 993 975-107	2 906 779	8GH 007 157-241
KDWHLO9458	2XS 005 020-002			11 882 263	9EL 856 416-001	2 906 779	8GH 007 157-248
KDWHLO9458	2XS 005 020-003			11 994 484	9XR 854 840-001	2 907 234	1EA 990 185-021
KDWHLO9460	8HG 006 294-031			11 998 512	9EL 859 020-001	2 907 237	9EL 990 186-001
KDWHLO9461	2XW 002 897-051			11 222 00090	1GA 006 991-071	20 379 338	9XB 136 202-005
KDWHLO9475	8GP 002 095-241			11 921 021	8GM 002 092-121	20 453 682	1FB 007 892-011
KDWHLO9482	2RL 008 366-021			14 002 010	1BL 007 834-047	20 453 766	1NB 007 892-001
KDWHLO9487	2RL 007 337-121			14 002 810	1KL 007 834-067	20002203560	2KA 001 386-281
KDWHLO9488	1G3 005 760-041			14 012 410	1NL 007 186-047	20002174120	2RL 008 060-111
KDWHLO9489	8HG 004 806-001			14 021 010	2BE 004 119-021	20002193480	9EL 118 603-001
KDWHLO9493	2AB 004 532-011			14 042 400	2PF 961 167-021	20002230900	9EL 115 003-011
KDWHLO9496	8GJ 002 525-941			14 371 518	1AB 006 213-027	20002283441	1AE 003 427-021
KDWHLO9500	8GA 002 071-251			14 371 907	2XS 955 031-001	20002800581	1EA 007 108-011
KDWHLO9500	8GA 002 071-258			14 379 469	8RA 003 660-007	20002800581	1EA 007 108-017
KDWHLO9503	9XD 857 445-801			1500714 VSE	9EL 110 013-001	20002800582	1EA 007 108-021
KDWHLO9507	2NE 006 609-001			1500715 VSE	9EL 110 014-001	20002800582	1EA 007 108-027
KDWHLO9507	2NE 006 609-007			182 032	8GP 002 067-261	20002801241	2JA 006 447-251
KDWHLO9508	2NE 006 609-011			182 032	8GD 002 084-251	20002801244	1A5 003 178-411
KDWHLO9508	2NE 006 609-017			202 560	2KA 001 386-281	20002804478	2VP 006 040-111
KDWHLO9510	2RL 007 337-101			2 048 861 4	2AB 004 532-031	20002804478	2VP 006 040-117
KDWHLO9511	2XW 007 146-001			2 050 343 5	2BM 002 847-011	20002804479	2VP 006 040-121
KDWHLO9514	9MK 860 255-001			2 050 343 6	2BM 002 847-021	20002804479	2VP 006 040-127
KDWHLO9517							



Manufacturer's no. / HELLA no.

Cross-Reference

Volvo	HELLA	Volvo	HELLA	Volvo	HELLA	Volvo	HELLA
20004374284	8GH 002 089-133	437 428 1	2SA 001 259-757	7 036 051 3	1BL 008 194-027	VOE4785122	2SD 002 582-027
20004374288	8GH 002 089-136	460 059	2KA 001 389-101	7 036 051 4	1KO 008 192-027	VOE6238300	9EL 113 639-021
20004374284	1AE 004 234-001	5 050 003 1	8GA 002 071-131	7 036 054 6	2XS 008 078-001	Volvo Trucks	
20004374292	2DA 996 012-041	5 050 003 1	8GA 002 071-133	7 036 054 6	2XS 008 078-007	1 103 907 8	2PG 004 361-011
20004374312	2XS 005 020-001	5 050 032	8GA 002 073-121	7 036 512 0	2BA 005 603-011	1 103 907 8	2PG 004 361-017
20004374312	2XS 005 020-002	5 050 032	8GA 002 073-123	7 036 512 0	2BA 005 603-017	1 103 939 9	2RL 006 846-011
20004374312	2XS 005 020-003	5 050 038	8GJ 002 525-131	7 036 512 0	2BA 005 603-011	1 103 940 0	8JB 850 343-011
20004374369	8HG 006 294-021	5 050 038	8GJ 002 525-136	7 036 512 0	2BA 005 603-017	1 103 955 3	2SE 002 578-701
20005174004	1AA 004 109-031	5 080 042	8JA 003 526-001	7 036 512 1	2ZR 005 603-061	1 103 955 3	2SE 002 578-707
20005174007	8JA 001 909-011	5 170 050	2VP 006 040-121	7 036 512 1	2ZR 005 603-067	1 111 717 2	1BL 008 193-011
20005230616	8GP 002 095-241	5 170 050	2VP 006 040-127	7 036 512 3	2DA 003 734-011	1 111 717 2	1BL 008 193-017
20005230620	8GH 002 089-251	5 170 062	2SD 003 182-051	7 050 630 2	8GD 002 084-251	1 111 717 3	1KO 008 191-041
20005230620	8GH 002 089-253	5 170 062	2SD 003 182-057	7 050 631	8GP 002 067-241	1 111 717 3	1KO 008 191-047
20005230620	8GH 002 089-258	5 174 001	8RA 002 016-121	7 050 637	8GH 002 090-251	1 111 738 2	1KO 008 191-047
20005239651	1G4 003 470-051	5 174 004	1AA 004 109-031	7 050 637	8GH 002 090-253	1 112 207 3	9GH 145 943-001
20007050631	8GP 002 067-241	5 174 005	2BA 003 014-111	7 050 637	8GH 002 090-258	1 122 000 90	9EL 856 416-011
20007050638	8GA 002 071-251	5 174 007	8JA 001 909-011	7 050 638	8GA 002 071-251	1 130 593 7	1BA 002 324-011
20007050638	8GA 002 071-258	5 230 615	8GP 002 068-241	7 050 638	8GA 002 071-258	1 130 788 0	8GA 002 083-131
28 005 813	1EA 007 108-011	5 230 616	8GP 002 095-241	7 057 450 2	8GD 002 084-131	1 170 618 3	9GH 993 984-001
28 005 813	1EA 007 108-017	5 230 620	8GH 002 089-251	7 057 470 7	8GM 002 092-121	1 170 649 5	9GH 993 984-001
28 012 453	2RL 006 846-001	5 230 620	8GH 002 089-253	7 349 573	9EL 126 294-001	1 170 649 6	9GB 993 345-001
288 139	2JA 004 531-011	5 230 620	8GH 002 089-258	7 352 959	2PF 001 648-161	1 171 398 0	9EL 860 627-011
288 262	2TM 006 717-047	5 232 297 1	9EL 146 491-001	7 353 869	2BE 001 259-061	1 188 108 8	1EA 993 975-091
290 349 0	9EL 137 307-001	5 232 298	9EL 110 536-011	7 356 266	9EL 052 476-001	1 188 108 8	1EA 993 975-097
3 098 192	1BL 005 380-011	5 232 299	9AG 104 328-001	7 356 293	9GT 134 655-007	1 188 593 4	2SE 004 623-001
3 098 233	1BL 005 380-021	5 239 599	1AB 001 100-001	7 305 294	9GT 143 133-007	1 188 593 4	2SE 004 623-007
3 098 408	1DL 005 600-097	5 239 651	1GA 003 470-051	7 305 312	1BL 007 834-047	1 199 270 3	2SA 001 634-121
3 098 408	1DL 005 600-107	5 403 000 1	2SA 005 200-331	7 305 313	1KL 007 834-067	1 199 448 3	9EL 856 416-001
3 101 340	2SB 001 259-261	5 929 107 0	8RL 002 009-021	7 305 318	2BE 004 119-021	1 199 448 3	9XR 854 840-001
3 107 139	2KA 001 386-231	505 001 1	8GH 002 089-133	7 305 320	1NL 007 186-047	1 402 120 0	2BM 002 847-021
3 126 106	2FX 003 146-001	505 001 1	8GH 002 089-136	7 324 425	1BL 008 193-011	1 437 293 7	8RA 002 014-241
3 343 851	9PF 085 642-001	517 003 1	2ZR 002 694-001	7 324 425	1BL 008 193-017	1 437 864 0	2BA 002 652-101
3 345 133	8GA 006 841-121	517 004 5	2SD 003 184-031	7 324 427	1KO 008 191-021	1 437 864 0	2BA 002 652-107
3 345 133	8GA 006 841-123	517 004 5	2SD 003 184-037	7 324 427	1KO 008 191-027	1 437 891 1	9GH 993 988-007
3 402 018	2KA 005 049-008	517 006 1	2SD 003 182-061	7 324 431	2PF 961 167-021	1 455 469 4	8HG 990 368-001
3 402 626	2JA 003 354-001	517 006 1	2SD 003 182-067	7 324 695	8JB 004 777-002	1 455 469 4	8HG 990 368-007
3 402 650	8GJ 002 525-251	544 218	2SB 001 259-261	7 324 695	9HD 155 239-001	1 459 256 5	2SB 009 001-157
3 402 650	8GJ 002 525-258	558 925	8NM 002 092-241	7 343 746	9GH 145 943-001	1 459 256 6	2BA 009 001-107
3 430 003	8GD 004 772-121	6 211 443	9EL 113 324-001	7 343 747	1KO 008 191-041	1 459 256 7	2ZR 009 001-117
3 430 003	8GD 004 772-123	6 212 166	9EL 854 912-001	7 344 553	1KO 008 191-047	1 459 256 8	2SB 009 001-401
3 930 861	2AA 001 200-001	6 229 297	2BE 001 278-021	7 344 553	8GH 002 090-133	1 461 842 9	2SB 009 001-501
3 930 862	2AA 001 200-131	6 229 299	2BE 001 278-011	7 504 326	8GH 002 090-136	1 461 843 0	2BA 009 001-071
3 930 863	2AA 001 200-001	6 233 508	2JA 001 360-001	7 504 326	8GP 002 066-241	1 461 843 0	2BA 009 001-077
3 930 863	2AA 001 200-011	6 234 659	9EL 087 769-001	7 506 353	8GA 002 073-241	1 461 843 1	2ZR 009 001-017
3 930 863	2AA 001 200-012	6 235 604	2BA 002 652-101	7 508 337	8GA 002 073-248	1 461 843 1	2ZR 009 001-017
3 950 305	1DL 005 600-097	6 235 604	2BA 002 652-107	7 508 337	8GA 002 073-248	1 500 714	9EL 110 014-001
3 950 306	1DL 005 600-107	6 238 300	9EL 113 639-021	784 423	2BA 001 227-211	1 500 715	9EL 092 435-011
30005080042	8JA 003 526-001	6 612 583	2KA 001 389-101	784 593	8JA 001 909-001	1 507 127 2	2PF 008 405-051
30005170031	2ZR 002 694-001	6 627 514	8RA 002 020-001	787 820	1A7 003 099-011	1 507 127 2	2PF 008 405-057
30005170061	2SD 003 182-061	6 627 514	8RA 002 020-002	8 001 010 34	2SA 961 167-011	1 507 128 0	9XB 161 749-007
30005170061	2SD 003 182-067	6 644 374	9EL 112 743-001	8 004 000 8	2RL 006 846-011	1 507 128 9	1KO 008 191-001
309 840 9	1DL 005 600-097	6 644 375	9EL 112 743-001	8 062 600 5	2XW 002 897-051	1 507 128 9	1KO 008 191-007
337 377	2SE 001 686-142	6 644 376	9EL 112 741-001	8 156 751	1NO 008 582-011	1 509 032 5	2XT 959 510-467
337 378	2SD 001 686-101	6 778 311	2SL 005 883-031	8 226 603 6	6NM 008 299-501	1 509 294 5	9EL 343 142-001
34 026 282	8GA 002 071-133	6 778 312	2SK 005 883-021	8 226 603 6	2SA 008 405-011	1 509 304 1	9EL 343 143-001
34 026 282	8GA 002 071-133	6 778 313	2SK 005 883-011	8 229 257 7	2SA 008 405-017	1 509 304 1	2SD 001 688-171
345 133	8GA 006 841-121	6 778 314	2SL 005 883-041	8 405 017	2SA 008 405-017	1 512 294 0	1BL 247 042-011
345 133	8GA 006 841-123	6 778 319	9EL 135 548-001	8 405 017	2SA 008 405-017	1 512 294 0	1BL 247 042-017
348 750	2SE 001 685-221	643 772	1A7 118 750-001	8 510 479 6	2PF 003 563-151	1 512 294 2	1KO 247 043-021
348 750	2SE 001 685-227	672 599	4RA 965 400-001	8 510 479 9	2PS 962 964-012	1 512 294 2	1KO 247 043-027
355 700	2ZR 001 423-001	7 019 926	8GM 002 092-241	8 511 107 1	9EL 860 627-001	1 516 393 4	9GT 137 236-007
356 720	2KA 001 389-101	7 030 531 5	2PF 006 679-007	8001331900003	9GH 152 654-007	1 518 711 5	2BM 002 652-051
362 540	2BA 001 221-031	7 030 532 2	2SA 006 679-027	8001331900008	2SA 005 603-021	1 519 667 0	1BL 247 042-137
362 541	2BA 001 221-041	7 030 532 2	2BA 003 236-021	8001331900010	2SA 005 603-027	1 519 667 2	1KO 247 043-197
363 716	2SE 001 685-201	7 030 532 4	2BA 003 236-031	8001331900017	2DA 005 603-031	1 566 865 0	8HG 006 294-091
398 1455	2VD 008 205-051	7 030 532 6	2DA 003 236-037	8003331900003	2DA 005 603-037	1 566 887 0	2ZR 001 423-001
398 1456	2VP 008 205-031	7 030 532 6	2KA 005 049-011	8003331900005	2BA 005 603-117	1 567 055 3	1GA 996 288-011
398 1458	2VD 008 205-041	7 030 533 0	2KA 005 049-017	8202331900001	2BA 005 603-117	1 567 055 3	1GA 996 288-012
398 1459	2VP 008 205-031	7 030 533 0	2BM 006 692-017	85 104 436	8KA 152 134-007	1 567 055 4	1GA 996 288-001
4 038 323	2AA 001 200-031	7 030 533 0	2BM 006 692-017	85 104 437	8WS 008 549-501	1 576 965 4	1GA 996 288-001
4 37 4278	2BA 001 227-021	7 030 533 0	2BM 006 692-021	85 104 765	2RL 008 060-111	1 578 652	2NE 001 423-011
4 373 253	6ZE 001 759-071	7 030 533 1	2BM 006 692-027	864 417	2RL 008 061-111	1 587 794	9GH 096 532-001
4 374 231	2KA 003 389-061	7 032 441 3	2NE 003 030-151	942 775	9EL 862 141-001	1 600 969 3	2KA 001 386-281
4 374 231	2KA 003 389-062	7 032 441 3	8RA 003 326-031	942 775	8HG 002 240-021	1 681 861 4	8RA 004 412-001
4 374 248	2BA 002 324-011	7 032 442 1	2DA 959 071-737	943 904	8GH 002 089-136	1 684 749 6	1BL 008 194-027
4 374 249	1GD 003 590-701	7 032 442 2	2BM 008 355-007	943 904	8GH 002 089-253	1 699 837	8KA 194 768-001
4 374 274	2SD 002 776-231	7 032 442 2	2BA 008 221-001	943 904	8GH 002 089-258	1 723 282 4	8GA 002 083-251
4 374 274	2SD 002 776-237	7 032 442 3	2BA 008 221-007	945 091	8GA 002 073-241	1 723 285 5	1AL 009 998-041
4 374 275	2SD 002 776-241	7 032 442 3	2BA 008 221-007	945 091	8GA 002 073-241	1 723 323 7	2BE 010 102-011
4 374 275	2SD 002 776-247	7 032 442 9	2BA 008 221-007	946 777	8GA 002 073-248	1 728 452	9AH 165 968-001
4 374 280	2PF 001 259-631	7 032 442 9	2PS 003 236-541	946 777	8GA 002 071-131	1 728 452	1EE 996 174-401
4 374 284	8GH 002 089-						

Manufacturer's no. / HELLA no.

Cross-Reference



Volvo Trucks	HELLA	Volvo Trucks	HELLA	Wuerth	HELLA
2 181 247 9	2PF 340 825-057	VOE16847496	8KA 194 768-001	812 42 2	2XS 955 232-001
2 192 909 4	2PT 010 458-841	VOE17228546	1BL 010 820-001	812 46 1	2NE 003 315-011
2 222 753 0	2PT 010 458-851	VOE4785120	2BE 002 582-031	812 46 2	2SE 003 167-031
2 227 275 4	9HB 163 085-001	VOE70324423	2BA 008 221-001	812 46 20	2SD 003 167-011
2 227 275 6	9HB 163 085-001	VOE70324423	2BA 008 221-007	812 46 3	2SL 003 567-311
2 227 276 3	8RA 009 362-001	ZM 2903490	9EL 137 307-001	812 46 30	2SK 003 567-331
2 227 276 5	8RA 009 362-001			812 46 31	2SK 003 567-321
2 227 277 3	9HB 161 122-007			812 46 4	2VD 005 300-551
2 227 277 5	9HB 161 122-012			997999999 9000001.	2SK 340 101-011
2 227 335 3	2SB 009 362-011			X02020	4RA 933 791-061
2 227 335 5	2SB 009 362-011			X02438	4RD 933 332-061
2 227 336 7	2SB 009 001-401				
2 227 336 9	2SB 009 001-501				
2 227 337 9	2BA 009 001-411				
2 227 338 1	2BA 009 001-511				
2 227 341 0	2PF 009 001-521				
2 801 243	1GA 006 876-001				
2 804 482	1GA 007 506-011				
2 804 482	1GA 007 506-012				
2 806 466	2VP 006 040-111				
2 806 466	2VP 006 040-117				
2 907 377	1GA 007 506-001				
2 907 377	1GA 007 506-002				
2 907 377	1GA 007 506-007				
20 846 995	8GP 008 285-001				
290 349 0	9EL 137 307-001				
363 716	2SE 001 685-201				
4 785 120	2BE 002 582-031				
4 785 121	2SD 002 582-011				
4 785 121	2SD 002 582-017				
4 785 537	2PF 001 648-161				
4 803 218	2SD 001 685-231				
4 803 218	2SD 001 685-232				
4 864 417	8HG 002 240-021				
4 864 457	8RA 003 326-011				
4 864 457	2ZR 007 694-001				
5 170 031	9EL 113 324-001				
6 211 443	9EL 854 912-001				
6 212 166	2BA 002 652-101				
6 235 604	2BA 002 652-107				
6 235 604	2KA 001 389-101				
6 612 583	8RA 002 020-001				
6 627 514	8RA 002 020-002				
6 627 514	9EL 112 744-001				
6 644 374	9EL 112 743-001				
6 644 375	9EL 112 741-001				
6 644 376	8RA 003 326-041				
6 774 450	8RA 003 326-047				
6 774 450	9GT 134 655-007				
7 030 529 3	9GT 143 133-007				
7 030 529 4	1KL 007 834-067				
7 030 531 3	2BE 004 119-021				
7 030 531 8	1NL 007 186-047				
7 030 532 0	8RA 002 020-001				
7 030 532 08	8RA 002 020-002				
7 030 532 6	2KA 005 049-011				
7 030 532 8	2KA 005 049-017				
7 032 441 7	8RA 002 020-001				
7 032 442 1	8RA 002 020-002				
7 032 442 2	2DA 959 071-737				
7 032 442 3	2BM 008 355-001				
7 032 442 3	2BM 008 355-007				
7 032 442 5	2BA 008 221-001				
7 032 442 5	2BA 008 221-007				
7 032 442 7	1BL 008 193-011				
7 032 442 7	1BL 008 193-017				
7 032 442 7	1KO 008 191-021				
7 032 442 7	1KO 008 191-027				
7 032 443 1	2PF 961 167-021				
7 032 469 5	8JB 004 777-001				
7 032 469 5	8JB 004 777-002				
7 033 102 6	1KL 007 834-027				
7 033 103 5	2SB 005 603-137				
7 034 374 6	9HD 155 239-001				
7 034 374 7	9GH 145 943-001				
7 034 569 0	2AB 004 532-051				
7 034 569 0	2AB 004 532-057				
7 034 592 4	2XS 005 020-001				
7 034 592 4	2XS 005 020-002				
7 034 592 4	2XS 005 020-003				
7 034 770 3	2SA 005 603-021				
7 034 770 3	2SA 005 603-027				
7 034 868 3	8HG 116 741-801				
7 035 395 9	9GD 341 063-007				
7 036 637 6	8RA 003 326-011				
7 036 637 6	8RA 003 326-017				
7 036 862 6	2ZR 002 985-261				
7 037 154 7	2DA 959 071-737				
7 037 481 3	2SB 008 805-021				
7 037 481 3	2SB 008 805-027				
7 349 573	9EL 126 294-001				
784 423	2BA 001 227-211				
784 593	8JA 001 909-001				
8 063 684 8	8HG 006 294-021				
8 156 751	2XW 002 897-051				
8 207 666 8	1F3 161 825-011				
8 416 309 1	2XD 011 557-501				
8 510 443 6	2RL 008 060-111				
8 510 443 7	2RL 008 061-111				
8 510 476 5	9EL 862 141-001				
8 513 665 4	2PF 959 590-212				
8 513 665 4	2PF 959 590-217				
8 513 665 4	2PF 959 590-218				
8 513 694 1	8KB 863 949-011				
8001331900022	2ZR 008 805-041				
8001331900022	2ZR 008 805-047				
8001331900025	9GH 158 051-007				
8003001900004	8GA 002 074-241				
8216271900001	2ZR 003 030-171				
965 826	8GA 002 073-121				
965 826	8GA 002 073-123				
967711	8GP 002 067-261				
VOE14592565	2SB 009 001-157				
VOE14592566	2BA 009 001-107				
VOE14592567	2ZR 009 001-117				
VOE15071272	2PF 008 405-051				
VOE15071272	2PF 008 405-057				
218001345048	2AB 004 532-257	505083	9EL 052 476-001	441.03.000.00	2SD 001 686-101
505095	9EL 112 743-001	505095	9EL 112 743-001	441.03.000.00	2XW 007 146-001
505096	9EL 112 741-001	505096	9EL 112 741-001	456.01.000.00	2SE 002 776-211
505104	2SB 001 301-021	505104	2KA 001 386-231	469.01.000.00	2SL 003 567-311
505108	2KA 001 386-231	505108	8RA 002 016-101	469.01.200.00	9EL 122 772-001
505109	8RA 002 016-101	505109	8RA 002 020-002	469.01.200.00	9EL 122 689-021
505110	2PF 003 057-001	505110	2KA 001 622-001	469.02.000.00	2SK 003 567-321
505112	2KA 001 330-001	505112	2JA 001 330-007	469.02.000.00	2SK 003 567-331
505115	2JA 001 330-007	505115	2VB 007 547-171	484.20.000.00	2BM 006 692-011
505118	2VD 007 547-181	505118	9EL 118 700-001	484.21.000.00	2BM 006 692-021
505120	9EL 118 701-001	505120	2XS 005 020-001	498.02.000.00	2SA 001 647-041
505121	2XS 005 020-002	505121	2XS 005 020-002	532.01.000.01	1BL 007 834-007
505122	2SD 002 582-011	505122	2SD 002 582-011		
505123	2SD 002 582-017	505123	2SD 002 582-021		
505123	2SD 003 184-031	505123	2SD 003 184-037		
505163	2SD 003 184-041	505163	2SD 003 184-047		
505163	2KA 001 389-101	505163	2DA 003 014-031		
505164	2DA 003 014-037	505164	2BA 003 014-011		
505169	2BA 003 014-051	505169	9EL 110 536-001		
505169	9EL 110 536-001	505169	2SD 006 040-131		
505170	2SD 006 040-137	505170	2SD 006 040-141		
505170	2SD 006 040-147	505170	2VA 006 040-291		
505174	2VPA 006 040-301	505174	2VPA 006 040-307		
505183	9EL 136 819-041	505183	9EL 137 792-031		
505183	9EL 137 792-031	505183	2KA 006 896-001		
505184	2KA 006 896-007	505184	2KA 006 896-007		
505185	2KA 003 168-021	505185	2KA 003 389-061		
505188	2KA 003 389-066	505188	2KA 003 389-068		
505188	2XT 007 945-027	505188	2VA 007 502-011		
505195	2VA 007 502-017	505195	2VP 007 502-041		
505195	8GM 002 092-121	505195	8GM 002 091-131		
505196	8GM 002 091-131	505196	8GA 002 071-121		
505196	8GA 002 066-121	505196	8GA 002 073-121		
505197	8GP 002 095-121	505197	2JA 001 357-002		
505198	2JA 001 357-002	505198	2JA 003 354-001		
505198	2JA 003 354-001	505198	9EL 120 240-011		
505201	2JA 001 360-001	505201	2JA 004 192-001		
505202	2AB 004 532-011	505202	2AB 004 532-011		
505203	2AB 004 532-001	505203	9XB 136 202-005		
505204	9EL 128 922-011	505204	2AB 004 074-027		
505210	2DA 343 106-201	505210	2DA 343 106-221		
505210	2DA 343 106-221	505210	2JA 343 720-081		
505215	2JA 343 720-051	505215	2JA 343 720-121		
505215	2JA 343 720-121	505215			
505216		505216			
506003		506003			
506004		506004			
506009		506009			
506032		506032			
506121		506121			
506127		506127			
506139		506139			
506151					

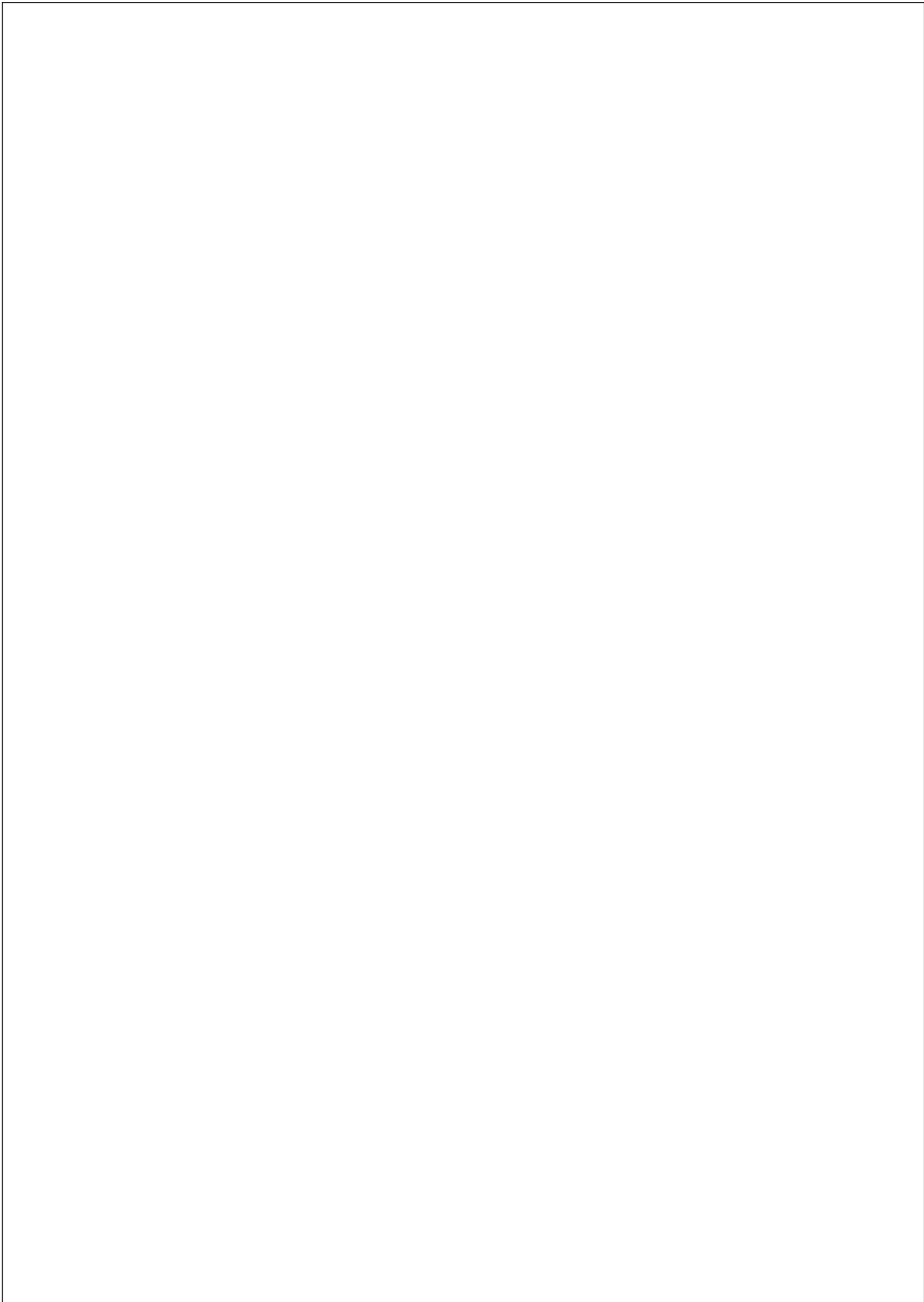

Type approval numbers



Type approval no.	Part no.	Page	Type approval no.	Part no.	Page	Type approval no.	Part no.	Page
E1 0130	8WS 008 549-001	1.54-1.55	E1 1212	1FA 008 284-011	1.27	E1 1395	2TM 008 645-651	2.148, 2.316
E1 0130	8WS 008 549-501	1.54-1.55	E1 1212	1FA 008 284-031	1.27	E1 1395	2TM 008 645-661	2.148, 2.316
E1 0130	8WT 008 549-101	1.55	E1 1212	1FA 008 284-811	1.27	E1 1395	2TM 008 645-941	2.148, 2.316
E1 0130	8WT 008 549-201	1.55	E1 1212	1FA 008 284-861	1.27	E1 1395	2TM 008 645-947	2.148
E1 0130	8WT 008 549-601	1.55	E1 122	1FA 007 133-021	1.29	E1 1395	2TM 008 645-951	2.148, 2.316
E1 0130	8WT 008 549-701	1.55	E1 122	1NA 007 133-001	1.29	E1 1395	2TM 008 645-957	2.148
E1 013738	1F3 011 815-031	1.16	E1 1224	2DA 007 858-037	2.203	E1 1396	2PS 008 645-001	2.150, 2.268
E1 016	2BA 007 135-001	2.213	E1 1240	2RL 008 060-001	3.11	E1 1396	2PS 008 645-007	2.150
E1 016	2BA 007 135-011	2.213	E1 1240	2RL 008 060-011	3.11	E1 1396	2PS 008 645-011	2.150
E1 02350	2VA 006 356-101	2.52	E1 1240	2RL 008 061-001	3.10	E1 1396	2PS 008 645-017	2.150
E1 02350	9EL 147 992-001	2.52	E1 1240	2RL 008 061-011	3.10	E1 1396	2PS 008 645-187	2.150
E1 102	2BE 003 184-051	2.68	E1 1240	2RL 008 062-001	3.10	E1 1396	2PS 008 645-301	2.268
E1 102	2BE 003 184-061	2.68	E1 1240	2RL 008 062-011	3.10	E1 1396	2PS 008 645-311	2.268
E1 102	9EL 118 703-001	2.68	E1 1240	2RL 008 063-001	3.11	E1 1396	2PS 008 645-361	2.268
E1 102	9EL 118 705-001	2.68	E1 1240	2RL 008 063-011	3.11	E1 1396	2PS 008 645-497	2.150
E1 1032	2PT 008 362-801	2.171	E1 1240	9EL 862 140-001	3.10-3.11	E1 1396	2PS 008 645-507	2.150
E1 1048	2SA 008 221-127	2.77	E1 1240	9EL 862 140-021	3.16-3.17	E1 1396	2PS 008 645-601	2.150
E1 1048	2XA 008 221-021	2.77	E1 1241	2RL 008 060-101	3.11	E1 1396	2PS 008 645-607	2.150
E1 1048	2XA 008 221-027	2.77	E1 1241	2RL 008 060-111	3.11	E1 1396	2PS 008 645-611	2.150, 2.268
E1 1049	2DA 008 221-167	2.77	E1 1241	2RL 008 061-101	3.10	E1 1396	2PS 008 645-621	2.150, 2.268
E1 1049	2XA 008 221-021	2.77	E1 1241	2RL 008 061-111	3.10	E1 1396	2PS 008 645-717	2.150, 2.268
E1 1049	2XA 008 221-027	2.77	E1 1241	2RL 008 062-101	3.10	E1 1396	2PS 008 645-787	2.150, 2.268
E1 1050	2NE 008 221-031	2.77	E1 1241	2RL 008 062-111	3.10	E1 1396	2PS 008 645-797	2.150, 2.268
E1 1050	2NE 008 221-037	2.77	E1 1241	2RL 008 063-101	3.11	E1 1396	2PS 008 645-891	2.150, 2.268
E1 1050	2NE 008 221-137	2.77	E1 1241	2RL 008 063-111	3.11	E1 1396	2PS 008 645-981	2.150
E1 1051	2BA 008 221-041	2.77	E1 1241	2RL 008 064-001	3.12	E1 1396	2PS 008 645-991	2.150, 2.268
E1 1051	2BA 008 221-047	2.77	E1 1241	2RL 008 064-101	3.12	E1 1396	2PS 011 422-341	2.150
E1 1051	2BA 008 221-147	2.77	E1 1241	9EL 862 141-001	3.10-3.12	E1 1396	2PS 011 422-347	2.150
E1 1052	2ZR 008 221-051	2.78	E1 1242	2RL 008 065-001	3.13	E1 1398	2PG 008 645-321	2.262
E1 1052	2ZR 008 221-057	2.78	E1 1242	2RL 008 065-011	3.13	E1 1398	2PG 008 645-331	2.262
E1 1052	2ZR 008 221-157	2.78	E1 1242	9EL 862 171-001	3.13	E1 1398	2PG 008 645-541	2.149, 2.262
E1 1059	2BM 008 355-001	2.216	E1 1243	2RL 008 065-101	3.13	E1 1398	2PG 008 645-561	2.149
E1 1059	2BM 008 355-007	2.216	E1 1243	2RL 008 065-107	3.13	E1 1398	2PG 008 645-567	2.149
E1 1072	2VP 340 450-021	2.277	E1 1243	2RL 008 065-111	3.13	E1 1398	2PG 008 645-631	2.149, 2.262
E1 1072	2VP 340 450-031	2.277	E1 1243	9EL 862 172-001	3.13	E1 1398	2PG 008 645-641	2.149, 2.262
E1 1072	2VP 340 450-441	2.276	E1 12815	2KA 001 389-101	2.184	E1 1398	2PG 008 645-831	2.149, 2.262
E1 1072	2VP 340 450-451	2.276	E1 12820	2KA 001 386-231	2.186	E1 1398	2PG 008 645-917	2.149
E1 1072	2VP 340 450-501	2.276	E1 12820	2KA 001 386-281	2.186	E1 1398	2PG 008 645-961	2.149, 2.262
E1 1072	2VP 340 450-511	2.276	E1 12820	2KA 001 386-301	2.186	E1 1398	2PG 008 645-967	2.149
E1 1072	9EL 340 208-001	2.276-2.277	E1 12820	2KA 001 386-497	2.186	E1 1398	2PG 008 645-971	2.149, 2.262
E1 1120	1FO 008 390-001	1.36	E1 1289	2RL 008 364-021	3.09	E1 1398	2PG 008 645-977	2.149
E1 1120	1FO 008 390-301	1.38	E1 1290	2RL 008 365-021	3.16	E1 1398	2PG 011 422-091	2.149
E1 1120	1FO 008 390-317	1.38	E1 1290	2RL 008 365-031	3.16	E1 1398	2PG 011 422-277	2.149
E1 1120	1FO 008 390-801	1.36	E1 12949	2KA 001 610-001	2.184	E1 1398	2TM 008 645-351	2.316
E1 1120	1FO 008 390-821	1.38	E1 12958	2KA 001 378-001	2.180	E1 1398	2TM 008 645-651	2.148, 2.316
E1 11371	2PF 340 825-057	2.263	E1 12958	2KA 001 378-041	2.180	E1 1398	2TM 008 645-661	2.148, 2.316
E1 11549	2SB 001 240-311	2.104	E1 12958	2KA 001 378-127	2.180	E1 1398	2TM 008 645-941	2.148, 2.316
E1 11550	2SA 001 240-331	2.104	E1 12969	2KA 001 622-001	2.185	E1 1398	2TM 008 645-947	2.148
E1 11551	2DA 001 240-341	2.104	E1 12969	9EL 108 651-001	2.185	E1 1398	2TM 008 645-951	2.148, 2.316
E1 11553	2TJ 001 633-211	2.168	E1 130	2SD 003 184-031	2.68	E1 1398	2TM 008 645-957	2.148
E1 11553	9EL 132 403-001	2.166, 2.168	E1 130	2SD 003 184-037	2.68	E1 1399	2RL 008 181-001	3.16
E1 11553	9EL 132 404-001	2.166, 2.168	E1 130	2SD 003 184-041	2.68	E1 1399	2RL 008 181-011	3.16
E1 11554	2TJ 001 633-211	2.168	E1 130	2SD 003 184-047	2.68	E1 1399	2RL 008 181-101	3.16
E1 11554	9EL 132 403-001	2.166, 2.168	E1 130	2SE 003 184-011	2.68	E1 1399	2RL 008 181-111	3.16
E1 11583	2TM 003 057-031	2.116	E1 130	2SE 003 184-017	2.68	E1 1399	2RL 008 182-001	3.17
E1 11584	2SA 003 057-021	2.116	E1 130	2SE 003 184-101	2.68	E1 1399	2RL 008 182-011	3.17
E1 11584	9EL 117 330-011	2.116	E1 130	8RA 123 251-005	2.68	E1 1399	2RL 008 182-101	3.17
E1 11591	2SA 003 236-041	2.126	E1 130	9EL 118 697-001	2.68	E1 1399	2RL 008 182-111	3.17
E1 11591	2SA 003 236-047	2.126	E1 130	9EL 118 700-001	2.68	E1 1399	2RL 008 183-001	3.17
E1 11591	2SA 003 236-048	2.126	E1 130	9EL 118 701-001	2.68	E1 1399	2RL 008 183-011	3.17
E1 11591	2SA 003 236-341	2.127	E1 130	9EL 121 431-001	2.68	E1 1399	2RL 008 183-101	3.17
E1 11591	9EL 120 201-001	2.126-2.127	e1 1309	2RL 007 900-121	3.59	E1 1399	2RL 008 183-111	3.17
E1 11592	2PF 003 389-041	2.160	e1 1309	2RL 007 900-171	3.59	E1 1399	9EL 862 140-031	3.16-3.17
E1 116	2SD 002 582-011	2.67	e1 1309	2RL 007 900-191	3.57	E1 1410	2PS 008 616-001	2.163, 2.266
E1 116	2SD 002 582-017	2.67	e1 1309	2RL 007 900-221	3.59	E1 1410	2PS 008 616-011	2.163, 2.266
E1 116	2SD 002 582-021	2.67	e1 1309	2RL 007 900-241	3.59	E1 1410	2PS 008 616-017	2.163, 2.266
E1 116	2SD 002 582-027	2.67	e1 1309	2RL 007 900-291	3.57	E1 1419	2RL 008 965-001	3.05
E1 116	2SE 002 582-071	2.67	e1 1309	2RL 007 900-501	3.56	E1 1419	2RL 008 965-011	3.05
E1 116	9EL 112 741-001	2.67	e1 1309	2RL 007 900-511	3.56	E1 1419	2RL 008 965-021	3.05
E1 116	9EL 112 743-001	2.67	e1 1309	2RL 007 900-521	3.56	E1 1419	2RL 008 966-001	3.06
E1 116	9EL 116 844-001	2.67	e1 1309	2RL 007 900-631	3.59	E1 1419	2RL 008 966-021	3.06
e1 1169	2XD 861 423-011	3.29	e1 1309	2RL 007 900-681	3.59	E1 1419	2RL 008 967-001	3.06
e1 1169	2XD 861 423-021	3.29	E1 1342	1N0 008 582-001	1.40	E1 1419	2RL 008 967-011	3.06
E1 11761	2PF 001 650-001	2.170	E1 1342	1N0 008 582-007	1.40	E1 1419	2RL 008 967-021	3.06
E1 11779	2PF 001 638-011	2.168	E1 1342	1N0 008 582-011	1.40	E1 1419	2RL 008 990-021	3.07
E1 11786	2PF 001 634-101	2.166	E1 1342	1N0 008 582-017	1.40	E1 1423	2BM 008 771-001	2.215
E1 11786	2TJ 001 633-211	2.168	E1 1342	1N0 008 582-037	1.40	E1 1423	2BM 008 771-007	2.215
E1 11786	9EL 132 403-001	2.166, 2.168	E1 1395	2PG 008 645-321	2.262	E1 1429	2PS 008 643-007	2.162, 2.267
E1 11786	9EL 132 404-001	2.166, 2.168	E1 1395	2PG 008 645-331	2.262	E1 1429	2PS 008 643-011	2.162, 2.267
E1 11793	2PF 003 014-071	2.119	E1 1395	2PG 008 645-541	2.149, 2.262	E1 1429	2PS 008 643-017	2.162, 2.267
E1 11793	2PF 003 014-301	2.119	E1 1395	2PG 008 645-561	2.149	E1 1429	2PS 008 643-021	2.162, 2.267
E1 11793	9EL 110 542-001	2.119	E1 1395	2PG 008 645-567	2.149	E1 1429	2PS 008 643-027	2.162, 2.267
E1 11794	2PF 001 648-161	2.170	E1 1395	2PG 008 645-631	2.149, 2.262	E1 1429	2PS 008 643-031	2.162, 2.267
E1 11794	2PF 001 648-171	2.170	E1 1395	2PG 008 645-641	2.149, 2.262	E1 1429	2PS 008 643-037	2.162, 2.267
E1 11794	9EL 108 435-001	2.170	E1 1395	2PG 008 645-831	2.149, 2.262	E1 1429	2PS 008 643-331	2.162, 2.267
E1 1196	8RA 008 405-001	2.74	E1 1395	2PG 008 645-917	2.149	E1 1433	1AB 008 888-041	1.62
E1 1196	8RA 008 405-007	2.74	E1 1395	2PG 008 645-961	2.149, 2.262	E1 1433	1AB 008 888-051	1.62
E1 1197	2SA 008 405-011	2.74	E1 1395	2PG 008 645-967	2.149	E1 14464	1K3 114 155-001	1.59
E1 1197	2SA 008 405-017	2.74	E1 1395	2PG 008 645-971	2.149, 2.262	E1 14466	1B3 114 179-001	1.59
E1 1197	2SA 008 405-021	2.74	E1 1395	2PG 008 645-977	2.149	E1 14468	1A3 003 370-041	1.58
E1 1197	2SA 008 405-027	2.74	E1 1395	2PG 011 422-091	2.149	E1 14468	1A3 125 195-015	1.58
E1 1201	2XS 008 479-001	2.191	E1 1395	2PG 011 422-277	2.149	E1 14470	1B3 114 179-001	1.59
E1 1201	2XS 008 479-007	2.191	E1 1395	2PS 008 645-001	2.150, 2.268	E1 14520	1FE 002 537-191	1.32
E1 1201	2XS 008 479-011	2.191	E1 1395	2PS 008 645-007	2.150	E1 14521	1F4 002 608-001	1.12
E1 1201	2XS 008 479-017	2.191	E1 1395	2PS 008 645-011	2.150	E1 14525	1A6 001 128-061	1.60
E1 1201	2XS 008 479-041	2.191	E1 1395	2PS 0				



Type approval numbers

Type approval no.	Part no.	Page	Type approval no.	Part no.	Page	Type approval no.	Part no.	Page
E1 1655	1FE 161 641-011	1.34	E1 1901	1F3 010 119-111	1.21	e1 2181	2RL 006 846-001	3.04
E1 1655	1FE 161 641-021	1.34	E1 1901	1F3 010 119-121	1.21	e1 2181	2RL 006 846-011	3.04
E1 1655	1FE 161 642-011	1.34	E1 1901	1F3 161 825-011	1.15, 1.21	e1 2181	2RL 006 846-101	3.04
E1 1655	1FE 161 644-011	1.34	E1 1901	1F3 161 825-081	1.15, 1.21	e1 2181	2RL 006 846-111	3.04
E1 1677	1AL 008 934-001	1.47	E1 1902	1F1 009 094-091	1.14	e1 2181	2RL 007 337-001	3.04
E1 1677	1AL 008 934-021	1.47	E1 1902	1F1 161 825-041	1.14	e1 2181	2RL 007 337-011	3.04
E1 1689	1NE 008 773-031	1.34	E1 1902	1F3 009 094-061	1.15	e1 2181	2RL 007 337-021	3.05
E1 1696	2PF 008 405-051	2.74	E1 1902	1F3 009 094-071	1.15	e1 2181	2RL 007 337-031	3.05
E1 1696	2PF 008 405-057	2.74	E1 1902	1F3 010 119-001	1.21	e1 2181	2RL 007 337-041	3.04
E1 1696	2PF 008 405-061	2.74, 2.234	E1 1902	1F3 010 119-101	1.21	e1 2181	2RL 007 337-101	3.04
E1 1696	2PF 008 405-067	2.74	E1 1902	1F3 161 825-031	1.15, 1.21	e1 2181	2RL 007 337-111	3.04
E1 1696	2PF 008 405-127	2.74	E1 1903	1BL 009 071-001	1.39	e1 2181	2RL 007 337-121	3.05
E1 1719	2RL 863 106-001	3.54, 3.59	E1 1903	1BL 009 071-007	1.39	e1 2182	2RL 007 550-001	3.07
E1 1719	2RL 863 106-011	3.54, 3.59	E1 1903	1BL 009 071-047	1.39	e1 2182	2RL 007 550-011	3.07
E1 1719	2RL 863 132-021	3.54	E1 1903	1BL 009 071-067	1.39	e1 2182	2RL 007 550-021	3.07
E1 1721	2RL 863 106-001	3.54, 3.59	E1 1928	1F8 006 800-301	1.18	e1 2182	2RL 007 551-001	3.08
E1 1721	2RL 863 106-011	3.54, 3.59	E1 1928	1F8 006 800-311	1.18	e1 2182	2RL 007 551-011	3.08
E1 1722	2PT 008 935-001	2.171	E1 1928	1F8 006 800-321	1.19	e1 2182	2RL 007 551-021	3.08
E1 1722	2PT 008 935-011	2.171	E1 1928	1F8 007 560-301	1.22	e1 2182	2RL 007 552-001	3.08
E1 1722	2PT 008 935-801	2.171	E1 1928	1F8 007 560-311	1.24	e1 2182	2RL 007 552-011	3.08
E1 1740	1FE 008 773-011	1.34	E1 1928	1F8 007 560-321	1.24	e1 2182	2RL 007 552-021	3.08
e1 1740	2RL 008 060-001	3.11	E1 1928	1F8 009 797-021	1.20	e1 2182	2RL 007 553-001	3.09
e1 1740	2RL 008 060-011	3.11	E1 1928	1F8 009 797-031	1.20	e1 2182	2RL 007 553-011	3.09
e1 1740	2RL 008 060-101	3.11	E1 1928	1F8 009 797-101	1.20	e1 2182	2RL 007 553-021	3.09
e1 1740	2RL 008 060-111	3.11	E1 1928	1F8 009 797-111	1.20	E1 2185	2ZR 005 700-191	2.200
e1 1740	2RL 008 061-001	3.10	E1 1928	1F8 009 797-321	1.20	E1 2186	2ZR 005 860-151	2.200
e1 1740	2RL 008 061-011	3.10	E1 1928	1F8 009 797-331	1.20	E1 2198	1KL 009 486-001	1.34
e1 1740	2RL 008 061-101	3.10	E1 1928	1F8 009 797-341	1.20	E1 2243	2RL 863 123-001	3.59
e1 1740	2RL 008 061-111	3.10	E1 1928	1F8 009 797-351	1.20	E1 2243	2RL 863 123-011	3.54
e1 1740	2RL 008 062-001	3.10	E1 1928	1F8 009 797-421	1.20	E1 2254	1F8 006 800-331	1.19
e1 1740	2RL 008 062-011	3.10	E1 1928	1F8 009 797-431	1.20	E1 2254	1F8 006 800-341	1.18
e1 1740	2RL 008 062-101	3.10	E1 1928	1F8 162 870-011	1.20, 1.22, 1.24	E1 2254	1F8 006 800-351	1.19
e1 1740	2RL 008 062-111	3.10	E1 1928	1F8 162 871-011	1.20, 1.24	E1 2254	1F8 006 800-361	1.18
e1 1740	2RL 008 063-001	3.11	E1 1928	1F8 162 872-011	1.18	E1 2254	1F8 007 560-331	1.24
e1 1740	2RL 008 063-011	3.11	E1 1928	1F8 162 873-011	1.18	E1 2254	1F8 007 560-341	1.24
e1 1740	2RL 008 063-101	3.11	E1 1928	1F8 162 874-011	1.19	E1 2254	1F8 009 797-121	1.20
e1 1740	2RL 008 063-111	3.11	E1 1951	1N0 009 295-011	1.10	E1 2254	1F8 009 797-131	1.20
e1 1740	2RL 008 065-001	3.13	E1 1951	1N0 009 295-021	1.10	E1 2254	1F8 165 946-011	1.20, 1.24
e1 1740	2RL 008 065-011	3.13	E1 1951	1N0 009 295-031	1.10	E1 2255	1F8 007 560-621	1.25
e1 1740	2RL 008 065-101	3.13	E1 1951	1N0 009 295-037	1.10	E1 2255	1F8 007 560-631	1.25
e1 1740	2RL 008 065-107	3.13	E1 1951	1N0 009 295-041	1.10	E1 2255	1F8 007 560-721	1.25
e1 1740	2RL 008 065-111	3.13	E1 1951	1N0 009 295-047	1.10	E1 2255	1F8 007 560-731	1.25
E1 1741	1FE 008 773-021	1.34	E1 1951	1N0 009 295-057	1.10	E1 2255	1F8 165 949-011	1.25
E1 1741	1FE 008 773-051	1.34	E1 1951	1N0 009 295-067	1.10	E1 22786	2BA 001 240-301	2.104
E1 1741	1FE 008 773-081	1.34	E1 1951	1N0 009 295-801	1.10	E1 22786	9EM 128 229-011	2.104
E1 1741	1FE 161 576-011	1.34	E1 196	2SD 001 699-061	2.28	E1 22796	2BA 001 277-011	2.210
E1 1753	1F8 006 800-401	1.18	E1 196	2SD 001 699-511	2.28	E1 22796	2BA 001 277-021	2.210
E1 1753	1F8 007 560-201	1.23	E1 196	2SE 001 699-071	2.28	E1 22808	2KA 003 168-021	2.184
E1 1753	1F8 007 560-211	1.23	E1 196	9EL 109 139-001	2.28	E1 22819	2KA 003 389-001	2.159
E1 1753	1F8 161 328-011	1.18, 1.20, 1.23	E1 198	2DA 007 421-001	2.202	E1 22819	2KA 003 389-011	2.159
E1 1765	2XD 009 051-001	3.14	E1 198	2DA 007 421-007	2.202	E1 22819	2KA 003 389-061	2.159, 2.327
E1 1765	2XD 009 051-011	3.14	E1 1981	2XD 861 423-011	3.29	E1 22819	2KA 003 389-062	2.159
E1 1765	2XD 009 051-021	3.14	E1 1981	2XD 861 423-021	3.29	E1 22819	2KA 003 389-068	2.159
E1 1765	2XD 009 052-001	3.15	E1 199	2DA 007 421-017	2.202	E1 22819	2KA 003 389-081	2.159
E1 1765	2XD 009 052-011	3.15	E1 199	2DA 007 421-027	2.202	E1 22819	2KA 003 389-211	2.159
E1 1765	2XD 009 053-001	3.14	E1 20	1NL 007 186-027	1.37	E1 22819	2KA 003 389-217	2.159
E1 1765	2XD 009 054-001	3.15	E1 20	1NL 007 186-047	1.37	E1 22831	2SE 003 184-011	2.68
e1 1774	2RL 008 364-021	3.09	E1 20	1NL 007 186-061	1.37	E1 22831	2SE 003 184-017	2.68
e1 1775	2RL 008 366-021	3.16	E1 2087	1F3 009 094-142	1.16	E1 22831	2SE 003 184-101	2.68
e1 1775	2RL 008 366-031	3.16	E1 2087	1F3 009 094-311	1.16	E1 22848	2KA 004 331-061	2.180
E1 18213	1N4 005 750-041	1.12	E1 2087	1F3 161 825-071	1.16	E1 22848	2KA 004 331-067	2.180
E1 18213	1N4 005 750-601	1.12	E1 2113	2XD 008 997-101	3.34	E1 22859	9EL 119 544-021	2.126-2.127, 2.129
E1 18213	1N4 005 750-801	1.12	E1 2113	2XD 009 048-101	3.34	E1 22859	9EL 119 544-101	2.129
E1 18213	1N4 135 224-011	1.12	E1 2113	2XD 009 475-001	3.34	E1 22861	2KA 004 525-001	2.184
E1 18216	1ND 003 590-401	1.31	E1 2113	2XD 009 475-011	3.34	E1 22871	2KA 005 049-008	2.180
E1 18216	1ND 005 700-001	1.31	E1 2113	2XD 009 475-021	3.34	E1 22871	2KA 005 049-011	2.180
E1 18216	1ND 005 700-021	1.31	E1 2113	2XD 009 475-031	3.34	E1 22871	2KA 005 049-017	2.180
E1 18216	1ND 005 700-061	1.31	E1 213	2SD 002 514-161	2.55	E1 22890	2KA 004 331-107	2.180
E1 18216	1ND 005 700-841	1.31	E1 213	2SE 002 514-171	2.55	E1 22910	2KA 006 896-001	2.184
E1 18216	1ND 136 933-011	1.31	E1 213	9EL 119 614-031	2.55	E1 22910	2KA 006 896-007	2.184
E1 18227	1NB 005 860-021	1.30	E1 21340	8RL 002 009-021	2.258	E1 22916	2KA 003 738-057	2.180
E1 18227	1NB 005 860-131	1.30	E1 2139	2RL 863 123-001	3.54	E1 2300	2PF 009 514-001	2.165, 2.264
E1 18227	1NB 005 860-801	1.30	E1 2139	2RL 863 123-011	3.54	E1 2300	2PF 009 514-011	2.165, 2.264
E1 18227	1NB 137 001-021	1.30	E1 21395	8RA 003 326-001	2.257	E1 2344	2PT 009 496-007	2.179
E1 18231	1NE 006 300-011	1.33	E1 21395	8RA 003 326-002	2.257	E1 2344	2PT 009 496-801	2.179
E1 18231	1NE 006 300-051	1.33	E1 21395	8RA 003 326-011	2.18, 2.257, 2.293	E1 2372	2PT 009 599-111	2.175
E1 18231	1NE 006 300-101	1.33	E1 21395	8RA 003 326-017	2.257	E1 2376	2VP 340 950-011	2.284
E1 18231	1NE 138 555-011	1.33	E1 21395	8RA 003 326-021	2.257	E1 2376	2VP 340 950-021	2.284
E1 18245	1N8 006 800-001	1.18	E1 2140	2RL 008 965-031	3.05	E1 2376	2VP 340 950-031	2.284
E1 18245	1N8 007 560-021	1.24	E1 2140	2RL 008 965-041	3.05	E1 2376	2VP 340 950-041	2.284
E1 18245	1N8 007 560-031	1.22	E1 2140	2RL 008 966-031	3.06	E1 2376	2VP 340 950-051	2.20, 2.284
E1 18245	1N8 148 103-011	1.22, 1.24	E1 2140	2RL 008 967-031	3.06	E1 2397	1BL 247 042-001	1.44
E1 18406	2NE 003 030-151	2.193	E1 2140	2RL 008 967-041	3.06	E1 2397	1BL 247 042-007	1.44
E1 18406	2NE 003 030-167	2.193	E1 21406	2DA 003 734-011	2.135	E1 2397	1BL 247 042-011	1.44
e1 18411	2NE 003 236-001	2.126	E1 21406	9EL 123 632-001	2.135	E1 2397	1BL 247 042-017	1.44
e1 18411	2NE 003 236-008	2.126	E1 2141	2XD 009 052-021	3.15	E1 2397	1BL 247 042-177	1.46
e1 18411	2NE 003 236-301	2.127	E1 2141	2XD 009 052-031	3.15	E1 2397	1BL 247 042-197	1.46
e1 18411	2NE 004 432-011	2.130	E1 2141	2XD 009 053-021	3.14	E1 2397	1KO 247 043-001	1.45
e1 18411	2SA 004 431-071	2.129	E1 21434	2DA 001 423-077	2.89	E1 2397	1KO 247 043-007	1.45
e1 18411	9EL 119 544-001	2.126-2.127, 2.129-2.130	E1 21624	2PF 001 259-631	2.114	E1 2397	1KO 247 043-011	1.45
			E1 21624	9EL 109 208-011	2.114	E1 2397	1KO 247 043-017	1.45
E1 18421	2NE 003 734-091	2.135	E1 21626	2PF 003 057-001	2.116	E1 2397	1KO 247 043-021	1.45
E1 1848	2BM 008 355-017	2.216	E1 21626	2PF 003 057-041	2.116	E1 2397	1KO 247 043-027	1.45
e1 1889	2RL 008 181-001	3.16	E1 21626	9EL 117 330-001	2.116	E1 2397	1KO 247 043-031	1.45
e1 1889	2RL 008 181-011	3.16	E1 21629	2PG 003 057-011	2.116	E1 2397	1KO 247 043-037	1.45
e1 1889	2RL 008 181-101	3.16	E1 21629	2PG 003 057-061	2.116	E1 2397	1KO 247 043-117	1.47
e1 1889	2RL 008 181-111	3.16	E1 21629	2PG 003 057-067	2.116	E1 2397	1KO 247 043-127	1.47
e1 1889	2RL							

Type approval numbers



Type approval no.	Part no.	Page	Type approval no.	Part no.	Page	Type approval no.	Part no.	Page
E1 242	2DA 003 014-031	2.118	E1 280	9EL 134 296-051	2.17-2.18, 2.286, 2.293	E1 31432	2VD 007 500-201	2.17, 2.286
E1 242	2DA 003 014-037	2.118	E1 280	9EL 134 301-001	2.17-2.18, 2.286, 2.293	E1 31432	2VD 007 500-221	2.17, 2.286
E1 243	2SD 004 431-011	2.129	E1 280	9EL 134 301-011	2.17-2.18, 2.286, 2.293	E1 31432	2VD 007 500-411	2.17, 2.286
E1 243	9EL 119 544-021	2.126-2.127, 2.129	E1 280	9EL 134 301-011	2.17-2.18, 2.286, 2.293	E1 31432	2VP 007 500-421	2.17, 2.286
E1 2439	2PF 340 000-111	2.147	E1 280	9EL 134 301-011	2.17-2.18, 2.286, 2.293	E1 31432	9EL 134 296-041	2.17-2.18, 2.286, 2.293
E1 2439	2PG 340 000-121	2.147	E1 291	2PS 003 748-121	2.142, 2.269	E1 31432	9EL 134 296-051	2.17-2.18, 2.286, 2.293
E1 24417	1A7 003 099-001	1.75	E1 291	2PS 003 748-127	2.142	E1 31432	9EL 134 301-001	2.17-2.18, 2.286, 2.293
E1 24417	1A7 003 099-011	1.75	E1 291	2PS 003 748-161	2.142, 2.269	E1 31432	9EL 134 301-011	2.17-2.18, 2.286, 2.293
E1 24417	1A7 117 596-001	1.75	E1 291	2PS 003 748-167	2.142	E1 31432	9EL 134 301-011	2.17-2.18, 2.286, 2.293
E1 24417	1A7 118 750-001	1.75	E1 291	9EL 147 910-001	2.142, 2.269	E1 31432	9EL 134 301-011	2.17-2.18, 2.286, 2.293
E1 24423	1A5 003 178-231	1.74	E1 2911	2KA 010 278-111	2.181	E1 31433	2SA 003 734-121	2.135
E1 24423	1A5 003 190-001	1.74	e1 2954	2RL 008 965-001	3.05	E1 31433	9EL 135 060-001	2.135
E1 24423	1A5 118 740-001	1.74	e1 2954	2RL 008 965-011	3.05	E1 31436	2SD 001 693-011	2.45
E1 24450	1A5 003 178-401	1.74	e1 2954	2RL 008 965-021	3.05	E1 31438	2SA 001 259-751	2.113
E1 24450	1A5 003 178-411	1.74	e1 2954	2RL 008 965-031	3.05	E1 31438	2SA 001 259-757	2.113
E1 24460	1AB 003 177-001	1.60	e1 2954	2RL 008 965-041	3.06	E1 31438	9EL 135 266-001	2.113
E1 24460	1AB 003 177-071	1.60, 1.79	e1 2954	2RL 008 966-001	3.06	E1 31443	2SA 004 431-071	2.129
E1 24460	1AB 003 177-791	1.60	e1 2954	2RL 008 966-021	3.06	E1 31443	2SA 005 200-331	2.128
E1 24460	1AB 004 231-001	1.79	e1 2954	2RL 008 967-001	3.06	E1 31443	9EL 119 544-001	2.126-2.127, 2.129-2.130
E1 24460	1AB 006 277-127	1.62	e1 2954	2RL 008 967-011	3.06	E1 31445	2SD 003 182-051	2.71
E1 24460	1VB 005 444-037	1.61	e1 2954	2RL 008 967-021	3.06	E1 31445	2SD 003 182-057	2.71
E1 24461	1AB 003 177-001	1.60	e1 2954	2RL 008 967-031	3.06	E1 31445	2SD 003 182-061	2.71
E1 24461	1AB 003 177-071	1.60, 1.79	e1 2954	2RL 008 967-041	3.06	E1 31445	2SD 003 182-067	2.71
E1 24461	1AB 003 177-791	1.60	e1 2954	2RL 008 967-051	3.06	E1 31445	2SE 003 182-011	2.71
E1 24461	1AB 004 231-001	1.79	e1 2954	2RL 008 967-061	3.07	E1 31445	2SE 003 182-017	2.71
E1 24461	1AB 006 277-127	1.62	e1 2989	2RL 010 743-001	3.35	E1 31445	2SE 003 182-021	2.71
E1 24461	1VB 005 444-037	1.61	e1 2989	2RL 010 743-011	3.35	E1 31445	2SE 003 182-027	2.71
E1 24496	1AG 003 434-051	1.67	E1 2989	2RL 010 743-021	3.35	E1 31445	9EL 118 613-001	2.71
E1 24496	1AG 003 434-137	1.67	E1 2989	2RL 010 743-031	3.35	E1 31445	9EL 118 614-011	2.71
E1 24496	1AG 003 434-251	1.67	E1 2989	2RL 010 743-041	3.35	E1 31446	2PF 961 167-021	2.165
E1 24496	9ES 120 743-001	1.67	E1 2989	2RL 010 743-051	3.35	E1 31446	9EL 137 241-001	2.165
E1 24504	1KB 003 177-061	1.61	E1 2989	2RL 010 743-061	3.35	E1 31450	2SA 001 638-021	2.168
E1 24504	1VB 005 444-037	1.61	E1 2989	2RL 010 743-071	3.35	E1 31452	2SW 003 014-131	2.118
E1 24523	1AE 003 427-011	1.63	E1 2989	2RL 010 743-081	3.35	E1 31452	2SY 003 014-121	2.118
E1 24523	1AE 003 427-021	1.63, 1.79	E1 2989	2RL 010 743-091	3.35	E1 31452	9EL 115 003-001	2.118
E1 24523	1AE 003 427-151	1.64	E1 2989	2RL 010 743-101	3.35	E1 31452	9EL 115 003-011	2.118
E1 24523	1AE 003 427-161	1.64	E1 2989	2RL 010 743-111	3.35	E1 31452	9EL 115 003-011	2.118
E1 24523	1AE 004 234-001	1.79	E1 2989	2RL 010 743-121	3.35	E1 31452	2SB 003 014-151	2.118
E1 24526	1A3 002 850-031	1.58, 1.72-1.73	E1 2989	2RL 010 743-131	3.35	E1 31453	2ST 003 014-141	2.118
E1 24540	1AG 003 434-051	1.67	E1 2989	8GH 008 358-241	4.07	E1 31453	9EL 115 003-021	2.118
E1 24540	1AG 003 434-137	1.67	E1 2989	8GP 002 067-241	4.11, 4.13	E1 31453	9EL 115 003-021	2.118
E1 24540	1AG 003 434-251	1.67	E1 303	1F8 007 560-011	1.22	E1 31453	9EL 115 003-035	2.118
E1 24540	9ES 120 743-001	1.67	E1 303	1F8 148 009-011	1.22	E1 31453	2SA 961 167-011	2.165
E1 24542	1A3 002 850-001	1.58, 1.72	E1 303	1F8 148 131-011	1.22, 1.24	E1 31468	2SA 006 679-027	2.166
E1 24542	1A3 002 850-031	1.58, 1.72-1.73	E1 303	1F8 165 940-011	1.19	E1 31470	2SD 001 680-271	2.28
E1 24542	1A3 005 649-007	1.58	E1 303	1F8 165 941-011	1.18	E1 31482	2SD 001 680-281	2.28
E1 2484	1AL 009 997-001	1.48	E1 303	1F8 165 942-011	1.19	E1 31482	2SD 001 680-391	2.28
E1 2484	1AL 009 997-041	1.48	E1 303	1F8 165 943-011	1.18	E1 31482	2SD 001 680-401	2.28
E1 2484	1AL 009 998-001	1.48	E1 303	1F8 165 947-011	1.20, 1.24	E1 31482	2SE 001 680-291	2.28
E1 2484	1AL 009 998-041	1.48	E1 3047	1F8 007 560-451	1.24	E1 31482	2SE 001 680-301	2.28
E1 2486	1BL 009 999-001	1.49	E1 3047	1F8 009 797-451	1.20	E1 31482	9EL 107 368-001	2.28
E1 2486	1BL 009 999-041	1.49	E1 3099	1F8 007 560-411	1.22	E1 31482	9EL 111 647-001	2.28
E1 2529	1FA 010 047-011	1.26	E1 3099	1F8 007 560-421	1.24	E1 3159	1AL 010 820-021	1.50
E1 2529	1FA 010 047-801	1.26	E1 3099	1F8 007 560-421	1.24	E1 3159	1BL 010 820-001	1.50
E1 2529	1NA 010 047-101	1.26	E1 3109	2XD 012 480-001	3.23	E1 3159	1BL 010 820-801	1.50
E1 2529	1NA 010 047-111	1.26	E1 3109	2XD 012 480-011	3.23	E1 3159	1BL 010 820-811	1.50
E1 2529	1NA 010 047-811	1.26	E1 3109	2XD 012 480-101	3.23	E1 3161	1F8 011 002-001	1.26
E1 2529	2PT 010 047-201	2.171	E1 3109	2XD 012 480-201	3.23	E1 3249	2ZR 996 188-061	2.199
E1 2529	2PT 010 047-821	2.171	E1 3109	2XD 012 480-211	3.23	E1 3249	2ZR 996 188-091	2.199
E1 2578	2PT 010 043-011	2.176	E1 3109	2XD 012 480-301	3.23	E1 3249	2ZR 996 188-121	2.199
E1 2578	2PT 010 043-021	2.176	E1 3109	2XD 012 480-311	3.23	E1 32611	2BA 001 221-031	2.210
E1 2578	2PT 010 043-031	2.176	E1 3109	2XD 012 480-321	3.23	E1 32611	2BA 001 221-041	2.210
E1 2578	2PT 010 043-041	2.176	E1 31242	8RA 003 660-007	2.258	E1 32611	9EL 110 014-001	2.210
E1 2578	2PT 010 043-801	2.176	E1 31290	8RA 002 016-101	2.256	E1 32611	2BA 001 416-011	2.211
E1 2586	2BE 010 102-001	2.218	E1 31290	8RA 002 016-111	2.256	E1 32611	2BA 001 416-021	2.211
E1 2586	2BE 010 102-011	2.218	E1 31291	8RA 002 015-031	2.256	E1 32611	9EL 110 736-001	2.211
E1 2586	2BE 010 102-101	2.218	E1 31298	8RA 003 734-101	2.136, 2.258	E1 32611	9EL 110 737-001	2.211
E1 2609	2KA 010 278-011	2.181, 2.325	E1 31315	2PG 003 057-011	2.116	E1 32619	2BA 003 014-011	2.119
E1 2609	2KA 010 278-017	2.181	E1 31315	2PG 003 057-061	2.116	E1 32619	9EL 110 536-001	2.119
E1 2609	2KA 010 278-021	2.182, 2.325	E1 31315	2PG 003 057-067	2.116	E1 32621	2BA 002 324-011	2.210
E1 2609	2KA 010 278-031	2.182, 2.325	E1 31315	2PS 003 057-051	2.116	E1 32621	2BA 002 324-021	2.210
E1 2609	2KA 010 278-051	2.182, 2.325	E1 31315	2PS 003 057-057	2.116	E1 32623	2BA 002 324-001	2.210
E1 2609	2KA 010 278-081	2.182	E1 31315	2TM 003 057-031	2.116	E1 32639	2BM 001 318-001	2.215
E1 2609	2KA 010 278-121	2.182	E1 31407	9EL 117 334-001	2.116	E1 32661	2BA 003 014-111	2.119
E1 2609	2KA 010 278-311	2.181	E1 31407	9EL 117 334-021	2.116	E1 32661	9EL 110 536-011	2.119
E1 2609	2KA 010 278-317	2.181	E1 31407	2XS 005 020-001	2.189, 2.324	E1 32670	1E5 996 124-001	1.73
E1 2609	2KA 010 278-321	2.182	E1 31407	2XS 005 020-002	2.189	E1 32670	9EL 113 639-021	1.79
E1 2609	2KA 010 278-411	2.181	E1 31407	2XS 005 020-003	2.189	E1 32692	2BM 002 847-011	2.214
E1 2609	2KA 010 278-421	2.182	E1 31407	2XS 005 020-011	2.189, 2.324	E1 32692	2BM 002 847-021	2.214
E1 2609	2KA 010 278-607	2.181, 2.325	E1 31407	2XS 005 020-017	2.189	E1 32692	9EL 115 830-001	2.214
E1 2609	2KA 010 278-617	2.181	E1 31407	2XS 005 020-021	2.189, 2.324	E1 32719	2BA 003 022-001	2.208
E1 2609	2KA 010 278-627	2.181, 2.325	E1 31407	2XS 005 020-047	2.189	E1 32719	2BA 003 022-002	2.208
E1 264	2SD 003 167-011	2.36, 2.285	E1 31407	2XS 005 020-067	2.189	E1 32719	2BA 003 022-037	2.208
E1 264	2SD 003 167-021	2.36, 2.285	E1 31407	2XS 005 020-077	2.189	E1 32719	2XD 003 022-061	2.208
E1 264	2SD 003 167-531	2.36	E1 31407	2XS 005 020-081	2.189	E1 32719	9EL 116 907-001	2.208
E1 264	2SD 003 167-541	2.36	E1 31407	2XS 005 020-091	2.189, 2.324	E1 32764	2BA 003 236-021	2.126
E1 264	2SE 003 167-031	2.36, 2.285</						



Type approval numbers

Type approval no.	Part no.	Page	Type approval no.	Part no.	Page	Type approval no.	Part no.	Page
E1 34463	1AA 143 897-011	1.79	e1 3829	2RL 863 106-001	3.54, 3.59	E1 44444	1FE 006 300-041	1.33
E1 34463	1EA 007 108-011	1.79	e1 3829	2RL 863 106-011	3.54, 3.59	E1 44444	1FE 006 300-261	1.33
E1 34463	1EA 007 108-017	1.79	e1 3829	2RL 863 123-001	3.54	E1 44444	1FE 138 520-011	1.33
E1 34463	1EA 007 108-021	1.79	e1 3829	2RL 863 123-011	3.54	E1 44444	1FE 158 877-011	1.33
E1 34463	1EA 007 108-027	1.79	e1 3829	2RL 863 132-021	3.54	E1 44445	1FE 006 300-081	1.33
E1 34517	1FE 005 478-011	1.64	E1 3831	1BL 012 488-001	1.46	E1 44484	1F8 006 800-191	1.18
E1 34517	1FE 005 478-021	1.64	E1 3831	1BL 012 488-021	1.46	E1 44484	1F8 006 800-221	1.19
E1 34548	1AE 003 427-011	1.63	E1 3831	1FO 011 988-021	1.52	E1 44484	1F8 007 560-041	1.22
E1 34548	1AE 003 427-021	1.63, 1.79	E1 3831	1FO 011 988-031	1.52	E1 44484	1F8 007 560-051	1.24
E1 34548	1AE 004 234-001	1.79	E1 3831	1FO 011 988-121	1.52	E1 44484	1F8 007 560-131	1.24
E1 34553	1F7 004 700-431	1.17	E1 3831	1FO 011 988-131	1.52	E1 44484	1F8 147 077-011	1.18
E1 3468	2XD 011 557-001	3.22	E1 3831	1NO 011 988-001	1.51	E1 44484	1F8 157 042-011	1.19
E1 3468	2XD 011 557-011	3.22	E1 3831	1NO 011 988-011	1.51	E1 44484	1F8 158 926-011	1.24
E1 3468	2XD 011 557-021	3.22	E1 3832	1NO 011 988-051	1.51	E1 44504	1AB 006 977-021	1.61
E1 3468	2XD 011 557-101	3.22	E1 3832	1NO 011 988-061	1.51	E1 4578	1AB 001 100-001	1.66
E1 3468	2XD 011 557-111	3.22	E1 4011	2PS 009 226-077	2.158	E1 47294	2KA 012 271-037	2.183, 2.326
E1 3468	2XD 011 557-121	3.22	E1 4011	2PS 009 226-087	2.158	E1 47294	2KA 012 271-047	2.183, 2.326
E1 3468	2XD 011 557-501	3.22	E1 405	2BA 004 119-017	2.134	E1 47294	2KA 012 271-057	2.183, 2.326
E1 348	1F7 004 700-431	1.17	E1 4079	1EE 996 374-001	1.82	E1 47294	2KA 012 271-067	2.183, 2.326
e1 3486	2RL 007 017-041	3.18	E1 4079	1EE 996 374-011	1.82	E1 47294	2KA 012 271-077	2.183, 2.326
e1 3486	2RL 007 017-051	3.18	E1 4079	1EE 996 374-021	1.82	E1 47294	2KA 012 271-087	2.183, 2.326
e1 3486	2RL 007 017-061	3.18	E1 4127	2DA 012 596-027	2.206	E1 47294	2KA 012 271-237	2.183, 2.326
e1 3486	2RL 007 017-071	3.18	E1 4127	2DA 012 596-037	2.206	E1 47294	2KA 012 271-277	2.183, 2.326
e1 3486	2RL 863 123-001	3.54	E1 4128	2DA 012 596-007	2.206	E1 488	1FA 007 133-021	1.29
e1 3486	2RL 863 123-011	3.54	E1 4128	2DA 012 596-017	2.206	E1 488	1NA 007 133-001	1.29
e1 3486	2XD 009 051-001	3.14	E1 42621	2BM 003 563-111	2.214	e1 4906	5DS 009 552-001	2.07, 2.330
e1 3486	2XD 009 051-011	3.14	E1 42623	2BA 003 734-001	2.136	E1 492	1DL 005 800-097	1.65
e1 3486	2XD 009 051-021	3.14	E1 42641	2BA 003 734-061	2.136	E1 492	1DL 005 800-107	1.65
e1 3486	2XD 009 052-001	3.15	E1 42657	2BA 001 423-087	2.89	E1 508	2PS 007 972-011	2.161
e1 3486	2XD 009 052-011	3.15	E1 42669	2BM 004 312-051	2.214	E1 508	2PS 007 972-017	2.161
e1 3486	2XD 009 052-021	3.15	E1 42669	2BM 004 312-061	2.214	e1 5109	2SD 343 910-001	2.52
e1 3486	2XD 009 052-031	3.15	E1 42680	2BA 004 119-001	2.134	E1 52253	8RA 123 251-005	2.68
e1 3486	2XD 009 053-001	3.14	E1 42710	2BM 004 965-801	2.214	E1 52621	2BM 006 692-011	2.217
e1 3486	2XD 009 053-021	3.14	E1 42712	2BE 003 014-251	2.119	E1 52621	2BM 006 692-017	2.217
e1 3486	2XD 009 054-001	3.15	E1 42712	2BE 003 014-257	2.119	E1 52621	2BM 006 692-021	2.217
E1 3503	2XD 012 480-001	3.23	E1 42712	9EL 115 003-055	2.119	E1 52621	2BM 006 692-027	2.217
E1 3503	2XD 012 480-011	3.23	E1 42748	2BA 005 603-001	2.133	E1 53209	2BE 003 014-251	2.119
E1 3503	2XD 012 480-101	3.23	E1 42748	2BA 005 603-007	2.133	E1 53209	2BE 003 014-257	2.119
E1 3503	2XD 012 480-111	3.23	E1 42749	2BA 005 603-011	2.133	E1 53210	2ST 003 014-141	2.118
E1 3503	2XD 012 480-201	3.23	E1 42749	2BA 005 603-017	2.133	E1 53210	9EL 115 003-021	2.118
E1 3503	2XD 012 480-211	3.23	E1 42763	2BA 002 652-101	2.209	E1 53211	2SW 003 014-131	2.118
E1 3503	2XD 012 480-301	3.23	E1 42763	2BA 002 652-107	2.209	E1 53211	2SY 003 014-121	2.118
E1 3503	2XD 012 480-311	3.23	E1 42763	9EL 134 658-001	2.209	E1 53211	9EL 115 003-001	2.118
E1 352	1S0 001 430-011	1.69	E1 42764	2BA 002 652-111	2.209	E1 53211	9EL 115 003-011	2.118
e1 35517	2XD 010 311-001	3.21	E1 42764	2BA 002 652-117	2.209	E1 53234	2SD 001 693-011	2.45
e1 35517	2XD 010 311-011	3.21	E1 42764	2BA 002 652-121	2.209	E1 53250	2SD 003 167-011	2.36, 2.285
e1 35517	2XD 010 311-021	3.21	E1 42764	2BA 002 652-127	2.209	E1 53250	2SD 003 167-021	2.36, 2.285
e1 35947	2RL 010 743-001	3.35	E1 42764	9EL 134 659-001	2.209	E1 53250	2SD 003 167-521	2.36
e1 35947	2RL 010 743-011	3.35	E1 42764	9EL 134 660-001	2.209	E1 53253	2SD 003 184-031	2.68
e1 35947	2RL 010 743-021	3.35	E1 42770	2BA 005 200-311	2.128	E1 53253	2SD 003 184-037	2.68
e1 35947	2RL 010 743-031	3.35	E1 42781	2BM 002 652-031	2.209	E1 53253	2SD 003 184-041	2.68
e1 35947	2RL 010 743-041	3.35	E1 42788	2BA 002 939-251	2.211	E1 53253	2SD 003 184-047	2.68
e1 35947	2RL 010 743-051	3.35	E1 43207	2SD 001 688-141	2.24	E1 53253	2SE 003 184-011	2.68
e1 35947	2RL 010 743-061	3.35	E1 43207	2SD 001 688-171	2.24	E1 53253	2SE 003 184-017	2.68
e1 35947	2RL 010 743-071	3.35	E1 43207	2SE 001 688-151	2.24	E1 53253	2SE 003 184-101	2.68
e1 35947	2RL 010 743-081	3.35	E1 43207	2SE 001 688-161	2.24	E1 53253	8RA 123 251-005	2.68
e1 35947	2RL 010 743-091	3.35	E1 43207	9EL 092 435-011	2.24	E1 53253	9EL 118 697-001	2.68
e1 35947	2RL 010 743-101	3.35	E1 43222	9EL 107 368-001	2.28	E1 53253	9EL 118 700-001	2.68
e1 35947	2RL 010 743-111	3.35	E1 43222	9EL 111 647-001	2.28	E1 53253	9EL 118 701-001	2.68
e1 35947	2RL 010 743-121	3.35	E1 43260	9EL 102 240-031	2.63	E1 53253	9EL 121 431-001	2.68
e1 35947	2RL 010 743-131	3.35	E1 43261	2SD 001 686-101	2.63	E1 53254	2BE 003 184-051	2.68
E1 36160	2ZR 996 188-061	2.199	E1 43261	2SE 001 686-142	2.63	E1 53254	2BE 003 184-061	2.68
E1 36160	2ZR 996 188-091	2.199	E1 43261	9EL 102 240-031	2.63	E1 53254	9EL 118 703-001	2.68
E1 36160	2ZR 996 188-121	2.199	E1 43322	2SD 001 680-271	2.28	E1 53254	9EL 118 705-001	2.68
E1 36194	2RL 011 484-001	3.20	E1 43322	2SD 001 680-281	2.28	E1 53256	2SW 003 185-041	2.73
E1 36194	2RL 011 484-011	3.20	E1 43322	2SD 001 680-391	2.28	E1 53256	2SW 003 185-047	2.73
E1 36194	2RL 011 484-021	3.20	E1 43322	2SD 001 680-401	2.28	E1 53256	9EL 118 633-001	2.73
E1 36194	2RL 011 484-101	3.20	E1 43322	2SE 001 680-291	2.28	E1 53257	2SD 003 182-051	2.71
E1 36194	2RL 011 484-111	3.20	E1 43322	2SE 001 680-301	2.28	E1 53257	2SD 003 182-057	2.71
E1 36194	2RL 011 484-121	3.20	E1 43331	2SD 002 514-161	2.55	E1 53257	2SD 003 182-061	2.71
E1 3661	2BA 013 236-011	2.121	E1 43331	2SE 002 514-171	2.55	E1 53257	2SD 003 182-067	2.71
E1 3661	2BA 013 236-021	2.121	E1 43331	9EL 119 614-031	2.55	E1 53257	2SE 003 182-011	2.71
E1 3661	2BA 013 236-131	2.124	E1 43332	2SD 001 699-061	2.28	E1 53257	2SE 003 182-017	2.71
E1 3661	2BA 013 236-141	2.124	E1 43332	2SD 001 699-511	2.28	E1 53257	2SE 003 182-021	2.71
E1 3661	2BA 013 236-211	2.121	E1 43332	2SE 001 699-071	2.28	E1 53257	2SE 003 182-027	2.71
E1 3661	2BA 013 236-221	2.121	E1 43332	9EL 109 139-001	2.28	E1 53257	9EL 118 613-001	2.71
E1 3661	2BA 013 236-331	2.124	E1 43370	2SE 002 578-701	2.55	E1 53257	9EL 118 614-011	2.71
E1 3661	2BA 013 236-341	2.124	E1 43370	2SE 002 578-707	2.55	E1 53259	2BE 003 185-031	2.73
E1 3661	2DA 013 236-031	2.121	E1 43370	9EL 146 491-001	2.55	E1 53259	9EL 119 397-001	2.73
E1 3661	2DA 013 236-151	2.123	E1 43388	2BE 002 582-031	2.67	E1 53270	2BE 003 182-091	2.71
E1 3661	2DA 013 236-231	2.121	E1 43388	9EL 112 744-001	2.67	E1 53270	2BE 003 182-101	2.71
E1 3661	2DA 013 236-351	2.123	E1 439	2PS 340 000-001	2.147	E1 53270	9EL 118 614-021	2.71
E1 3661	2SA 013 236-041	2.121	E1 439	2PS 340 000-011	2.147, 2.270	E1 53274	2BE 003 347-001	2.219
E1 3661	2SA 013 236-161	2.123	E1 439	2PS 340 000-021	2.147	E1 53274	9EL 120 224-001	2.219
E1 3661	2SA 013 236-241	2.121	E1 439	2PS 340 000-041	2.147	E1 53288	2SD 003 409-327	2.45
E1 3661	2SA 013 236-361	2.123	E1 439	2PS 340 000-051	2.147	E1 53335	2SD 001 680-271	2.28
E1 3661	2SB 013 236-371	2.123	E1 439	2PS 340 000-171	2.147	E1 53335	2SD 001 680-281	2.28
E1 3662	2BA 013 236-181	2.123	E1 4414	1A3 001 120-001	1.59	E1 53335	2SD 001 680-391	2.28
E1 3662	2BA 013 236-191	2.123	E1 44404	1F4 005 750-101	1.12	E1 53335	2SD 001 680-401	2.

Type approval numbers



Type approval no.	Part no.	Page	Type approval no.	Part no.	Page	Type approval no.	Part no.	Page
E1 584	2PF 003 563-187	2.169	E1 799	2DA 008 136-027	2.204	E1 979	2KA 008 224-307	2.181
E1 586	2BA 005 603-117	2.133	E1 799	2DA 008 136-031	2.204	E1 989	2BA 008 260-001	2.212
E1 597	2KA 007 929-001	2.185	E1 801	2VP 340 450-141	2.277	E1 989	2BA 008 260-007	2.212
E1 597	2KA 007 929-007	2.185	E1 801	2VP 340 450-151	2.277	E1 989	2BA 008 260-017	2.212
E1 597	2KA 340 828-001	2.327	E1 801	9EL 146 838-001	2.08, 2.17, 2.188, 2.276-2.277, 2.286	E1 999	1F5 008 273-041	1.17
E1 6189	1AL 010 820-021	1.50				E1 999	1F5 154 875-011	1.17
E1 6189	1BL 010 820-001	1.50	E1 817	2RL 007 900-001	3.57	E11 20668	8RA 009 226-117	2.158
E1 6189	1BL 010 820-801	1.50	E1 817	2RL 007 900-151	3.57	E11 20668	8RA 009 226-127	2.158
E1 6189	1BL 010 820-811	1.50	E1 817	2RL 007 900-171	3.59	E11 20668	8RA 009 226-137	2.158
E1 6190	1F8 011 002-001	1.26	E1 817	2RL 007 900-191	3.57	E11 3011	2XS 205 020-001	2.190
E1 63217	2VD 005 300-551	2.18, 2.293	E1 817	2RL 007 900-201	3.57	E11 3011	2XS 205 020-007	2.190
E1 63217	2VD 005 300-581	2.18, 2.293	E1 817	2RL 007 900-211	3.57	E11 3011	2XS 205 020-011	2.190
E1 63217	2VD 007 500-091	2.17, 2.286	E1 817	2RL 007 900-251	3.57	E11 3011	2XS 205 020-017	2.190
E1 63217	2VD 007 500-111	2.17, 2.286	E1 817	2RL 007 900-291	3.57	E11 3011	2XS 205 020-021	2.190
E1 63217	2VD 007 500-201	2.17, 2.286	E1 817	2RL 007 900-501	3.56	E11 3011	2XS 205 020-027	2.190
E1 63217	2VD 007 500-221	2.17, 2.286	E1 817	2RL 007 900-511	3.56	E11 3011	2XS 205 020-031	2.190
E1 63217	2VD 007 500-411	2.17, 2.286	E1 817	2RL 007 900-521	3.56	E11 3011	2XS 205 020-037	2.190
E1 63217	2VP 007 500-421	2.17, 2.286	E1 817	2RL 007 900-601	3.57	E11 3011	2XS 205 020-041	2.190
E1 63217	9EL 134 296-041	2.17-2.18, 2.286, 2.293	E1 817	2RL 007 900-611	3.57	E11 3011	2XS 205 020-047	2.190
E1 63217	9EL 134 296-051	2.17-2.18, 2.286, 2.293	E1 817	2RL 007 900-681	3.59	E11 3011	2XS 205 020-051	2.190
E1 63217	9EL 134 301-001	2.17-2.18, 2.286, 2.293	E1 8371	1NB 004 691-147	1.61	E11 3011	2XS 205 020-057	2.190
E1 63217	9EL 134 301-011	2.17-2.18, 2.286, 2.293	E1 8438	2NE 005 603-071	2.133	E11 3011	2XS 205 020-121	2.190
E1 63217	9EL 134 301-011	2.17-2.18, 2.286, 2.293	E1 8438	2NE 005 603-077	2.133	E11 3011	2XS 205 020-127	2.190
E1 63217	9EL 134 301-011	2.17-2.18, 2.286, 2.293	E1 844	1F8 007 560-561	1.25	E11 3011	2XS 205 020-131	2.190
E1 63217	9EL 134 301-011	2.17-2.18, 2.286, 2.293	E1 844	1F8 007 560-571	1.25	E11 3011	2XS 205 020-137	2.190
E1 63225	2BE 002 776-251	2.72	E1 8465	2NE 002 985-001	2.193	E11 3011	2XS 205 020-151	2.190
E1 63225	2BE 002 776-257	2.72	E1 8466	2NE 002 985-007	2.193	E11 3011	2XS 205 020-157	2.190
E1 63225	2BE 002 776-261	2.72	E1 8486	2NE 003 315-011	2.194	E11 3011	2XS 205 020-171	2.190
E1 63225	2BE 002 776-267	2.72	E1 8486	9EL 119 977-001	2.194	E11 3011	2XS 205 020-177	2.190
E1 63225	9EL 134 741-021	2.72	E1 8496	2NE 001 423-011	2.89, 2.307	E11 3016	2PF 009 226-097	2.158
E1 63225	9EL 134 742-021	2.72	E1 8496	9EL 101 353-001	2.89, 2.307	E11 3017	2XS 009 226-107	2.158
E1 63230	2SD 002 776-231	2.72	E1 86	2PS 006 717-031	2.138	E12 1001	1A3 996 002-051	1.57
E1 63230	2SD 002 776-237	2.72	E1 86	2PS 006 717-032	2.138	E12 1001	1A3 996 026-011	1.73
E1 63230	2SD 002 776-241	2.72	E1 86	2PS 006 717-037	2.138	E12 1001	1A3 996 026-021	1.73
E1 63230	2SD 002 776-247	2.72	E1 86	2PS 006 717-051	2.138	E12 1001	1A3 996 026-121	1.73
E1 63230	2SE 002 776-211	2.72	E1 86	2PS 006 717-057	2.138	E12 1002	1A3 996 002-051	1.57
E1 63230	2SE 002 776-217	2.72	E1 86	2PS 006 717-061	2.138	E12 1002	1A3 996 026-011	1.73
E1 63230	2SE 002 776-221	2.72	E1 86	2PS 006 717-067	2.138	E12 1002	1A3 996 026-021	1.73
E1 63230	9EL 134 739-001	2.72	E1 86	2PS 006 717-071	2.138	E12 1002	1A3 996 026-121	1.73
E1 63230	9EL 134 740-001	2.72	E1 86	2PS 006 717-077	2.138	E12 1002	1AD 996 018-001	1.102
E1 63230	9EL 137 307-001	2.72	E1 86	9EL 141 135-031	2.138	E12 1006	2SE 997 088-001	2.24
E1 63230	9EL 137 308-001	2.72	E1 864	2VP 340 400-121	2.298	E12 20001	1A3 990 016-011	1.72
E1 63253	2BA 003 236-541	2.127	E1 864	2VP 340 400-131	2.298	E12 20001	1A3 996 002-161	1.72
E1 63255	2VA 006 356-101	2.52	E1 864	2VP 340 400-147	2.298	E12 20001	1A3 996 002-181	1.58
E1 63255	9EL 147 992-001	2.52	E1 864	2VP 340 400-157	2.298	E12 20001	1A3 996 002-191	1.72
E1 645	1N4 007 893-001	1.11	E1 864	2VP 340 400-157	2.298	E12 20001	1A3 996 002-211	1.58
E1 645	1N4 007 893-821	1.11	E1 864	2VP 340 400-451	2.298	E12 20001	1A3 996 002-261	1.57
E1 645	1N4 149 531-011	1.11	E1 864	2VP 340 400-471	2.298	E12 20001	1A3 996 002-531	1.58
E1 646	1F4 007 893-021	1.11	E1 864	9EL 340 203-001	2.298	E12 20002	1A3 996 002-161	1.72
E1 646	1F4 007 893-081	1.11	E1 864	9EL 340 203-011	2.298	E12 20002	1A3 996 002-181	1.58
E1 646	1F4 007 893-141	1.12	E1 864	9EL 340 203-011	2.298	E12 20002	1A3 996 002-191	1.72
E1 646	1F4 007 893-811	1.11	E1 8703	2ZR 003 014-091	2.119	E12 20002	1A3 996 002-211	1.58
E1 646	1F4 007 893-841	1.11	E1 8703	9EL 110 544-001	2.119	E12 20002	1A3 996 002-261	1.57
E1 646	1F4 007 893-871	1.12	E1 8704	2ZR 001 423-001	2.89, 2.307	E12 20002	1A3 996 002-531	1.58
E1 646	1F4 149 537-011	1.11	E1 8704	9ES 106 588-001	2.89, 2.307	E12 20004	1AD 996 018-641	1.102
E1 646	1F4 157 022-011	1.12	E1 8708	2ZR 002 694-001	2.201	E12 20004	1AD 996 018-651	1.102
E1 647	1F4 007 893-201	1.11	E1 8708	9EL 113 928-001	2.201	E12 2002	1A3 990 016-011	1.72
E1 647	1F4 007 893-241	1.11	E1 8709	2ZR 001 193-011	2.201	E12 23003	2JB 996 012-121	2.120
E1 647	1F4 007 893-911	1.11	E1 8712	2PF 002 985-291	2.193	E12 23003	2ZR 996 012-101	2.120
E1 647	1F4 007 893-921	1.11	E1 8712	2ZR 002 985-081	2.193	E12 23003	2ZR 996 012-111	2.120
E1 647	1F4 160 302-011	1.11	E1 8712	2ZR 002 985-261	2.193	E12 23005	2ZR 997 506-391	2.197
E1 648	1NB 007 892-001	1.29	E1 8726	2ZR 003 030-171	2.193	E12 23007	2ZR 997 506-691	2.197, 2.329
E1 648	1NB 007 892-041	1.29	E1 8728	2JA 001 357-002	2.220	E12 27092	2SE 997 088-001	2.24
E1 648	1NB 007 892-821	1.29	E1 8728	2ZR 003 236-051	2.126, 2.239	E12 3021	2VA 997 113-001	2.46
E1 649	1FB 007 892-011	1.29	E1 8728	2ZR 003 236-057	2.126	E12 3021	9EL 997 453-001	2.46
E1 649	1FB 007 892-071	1.29	E1 8728	2ZR 003 236-311	2.127	E12 3024	2VA 998 531-031	2.52
E1 649	1FB 007 892-131	1.29	E1 8728	9EL 200 432-001	2.130	E12 3024	9EL 997 310-001	2.52
E1 649	1FB 007 892-811	1.29	E1 8728	9EL 119 544-111	2.126-2.127, 2.130, 2.239	E12 38007	2NE 996 012-021	2.120
E1 649	1FB 007 892-841	1.29	E1 8731	2ZR 003 734-041	2.135	E12 4004	2KA 997 011-001	2.183
E1 649	1FB 149 519-011	1.29	E1 8731	9EL 123 635-001	2.135	E12 4004	2KA 997 011-011	2.183
E1 65	2DA 005 739-111	2.202	E1 8732	2ZR 003 315-041	2.194	E12 4031	2KA 998 523-001	2.185
E1 65	2DA 005 739-117	2.202	e1 8740	2ZR 996 012-111	2.120	E12 4033	2KA 997 011-021	2.183
E1 650	1NA 007 891-041	1.28	E1 8743	2ZR 004 542-001	2.200	E12 4035	2SE 997 088-001	2.24
E1 650	1NA 007 891-821	1.28	E1 8750	2ZR 001 421-101	2.115	E12 4038	2SE 997 111-011	2.53
E1 651	1FA 007 891-061	1.28	E1 877	1NL 008 090-031	1.36	E12 4038	2SE 997 111-021	2.53
E1 651	1FA 007 891-811	1.28	E1 877	1NL 008 090-037	1.36	E12 4038	9EL 997 451-001	2.53
E1 651	1FA 007 891-841	1.28	E1 877	1NL 008 090-117	1.36	E12 4038	9EL 997 452-001	2.53
E1 651	1FA 149 504-011	1.28	E1 877	1NL 008 090-301	1.37	E12 4043	2KA 997 122-001	2.181
E1 6517	2RL 007 900-121	3.59	E1 877	1NL 008 090-317	1.38	E12 4054	2SD 996 030-021	2.54
E1 6517	2RL 007 900-221	3.59	E1 877	1NL 008 090-821	1.36	E12 4054	2SE 996 030-011	2.54
E1 6517	2RL 007 900-241	3.59	E1 8770	2ZR 005 603-061	2.133	E12 4054	9EL 990 142-001	2.54
E1 6517	2RL 007 900-631	3.59	E1 8770	2ZR 005 603-067	2.133	E12 6040	2SD 997 006-021	2.70
E1 681	2SB 001 423-097	2.89	E1 8772	2ZR 005 200-301	2.128	E12 6040	2SD 997 006-031	2.70
E1 6919	2VA 011 900-001	2.57	E1 878	2BA 008 221-001	2.77	E12 6040	2SE 997 006-011	2.70
E1 6919	2VA 011 900-011	2.57	E1 878	2BA 008 221-007	2.77	E12 6041	2BA 996 012-061	2.120
E1 6919	2VA 011 900-021	2.57	E1 878	2BA 008 221-107	2.77	E12 6041	2BA 996 012-071	2.120
E1 6919	2VA 011 900-031	2.57	E1 879	2PF 008 221-011	2.78	E12 6041	2BA 996 012-147	2.120
E1 71	2SK 340 101-001	2.285	E1 879	2PF 008 221-017	2.78	E12 6041	9EL 990 034-041	2.120
E1 71	2SK 340 101-011	2.285	E1 879	2PF 008 221-177	2.78	E12 6044	2BA 997 027-031	2.139
E1 71	2SK 340 101-021	2.285	E1 917	1BL 008 193-001	1.41	E12 6046	2SD 998 531-057	2.53
E1 71	2SK 340 101-031	2.285	E1 917	1BL 008 193-007	1.41	E12 6046	2SD 998 531-067	2.53
E1 71	9EL 340 201-001	2.285	E1 917	1BL 008 193-011	1.41	E12 6060	2BA 996 027-001	2.211
E1 7197	1VB 005 444-037	1.61	E1 917	1BL 008 193-017	1.41	E12 6072	2SE 997 111-011	2.53
E1 7402	1BL 005 380-011	1.62	E1 917	1BL 008 194-001	1.42	E12 6072	2SE 997 111-021	2.53
E1 7402	1BL 005 380-021	1.62	E1 917	1BL 008 194-007	1.42	E12 6072	9EL 997 451-001	2.53
E1 7402	1BL 005 380-031	1.62	E1 917	1BL 008 194-027	1.42	E12 6072	9EL 997 452-001	2.53
E1 7402	1BL 005 380-041	1						



Type approval numbers

Type approval no.	Part no.	Page	Type approval no.	Part no.	Page	Type approval no.	Part no.	Page
E12 7049	2PF 996 112-031	2.170	E13 9531	9EL 136 825-011	2.32	E17 346	8RA 002 020-031	2.259
E12 7058	2SD 997 006-021	2.70	E13 9531	9EL 136 833-011	2.32	E17 346	8RA 002 020-051	2.259
E12 7058	2SD 997 006-031	2.70	E17 0001	2PG 008 434-001	2.169	E17 353	8RB 004 713-001	2.257
E12 7058	2SE 997 006-011	2.70	E17 0005	2VB 341 032-111	2.46	E17 378	2PG 006 717-021	2.138
E12 7061	2DA 997 027-021	2.139	E17 0005	2VB 341 032-117	2.46	E17 378	2PG 006 717-027	2.138
E12 7064	2SD 998 531-057	2.53	E17 0005	2VB 341 032-121	2.46	E17 378	2PS 006 717-031	2.138
E12 7064	2SD 998 531-067	2.53	E17 0005	2VB 341 032-127	2.46	E17 378	2PS 006 717-032	2.138
E12 7075	2SA 996 012-091	2.120	E17 0005	2VB 341 032-141	2.46	E17 378	2PS 006 717-037	2.138
E12 7093	2PF 996 012-051	2.120	E17 0005	2VB 341 032-547	2.46	E17 378	2PS 006 717-051	2.138
E12 7098	2SE 997 111-011	2.53	E17 0005	2VP 341 032-537	2.46	E17 378	2PS 006 717-057	2.138
E12 7098	2SE 997 111-021	2.53	E17 0069	2NR 344 169-441	2.96, 2.315	E17 378	2PS 006 717-061	2.138
E12 7098	9EL 997 451-001	2.53	E17 0069	2NR 344 169-461	2.96, 2.315	E17 378	2PS 006 717-067	2.138
E12 7098	9EL 997 452-001	2.53	E17 0071	2VP 345 900-011	2.27, 2.301	E17 378	2PS 006 717-071	2.138
E12 7103	2VA 997 113-001	2.46	E17 0071	2VP 345 900-021	2.27, 2.301	E17 378	2PS 006 717-077	2.138
E12 7103	9EL 997 453-001	2.46	E17 0071	2VP 345 900-091	2.27, 2.301	E17 378	2TM 006 717-047	2.138
E12 7106	2XS 005 639-001	2.117	E17 0071	2VP 345 900-101	2.27, 2.301	E17 378	9EL 141 135-021	2.138
E12 7106	2XS 005 639-002	2.117	E17 0071	2VP 345 900-131	2.27, 2.301	E17 378	9EL 141 135-031	2.138
E12 7111	2VA 998 531-031	2.52	E17 0071	2VP 345 900-141	2.27, 2.301	E17 3806	2NE 006 609-001	2.195
E12 7111	9EL 997 310-001	2.52	E17 0071	2VP 345 900-201	2.25, 2.299	E17 3806	2NE 006 609-007	2.195
E12 7113	2BE 997 131-081	2.69	E17 0071	2VP 345 900-211	2.25, 2.299	E17 3806	2NE 006 609-011	2.195
E12 7113	2BE 997 131-207	2.69	E17 0071	2VP 345 900-221	2.25, 2.299	E17 3806	2NE 006 609-017	2.195
E12 7113	9EL 997 459-001	2.69	E17 0071	2VP 345 900-231	2.25, 2.299	E17 3806	2NE 006 609-187	2.195
E12 7114	2BE 997 131-207	2.69	E17 0071	2VP 345 900-241	2.26, 2.300	E17 3806	2NE 006 609-197	2.195
E12 7114	2SD 997 131-051	2.69	E17 0071	2VP 345 900-251	2.26, 2.300	E17 3806	9EL 141 612-001	2.195
E12 7114	2SD 997 131-367	2.69	E17 0071	2VP 345 900-261	2.26, 2.300	E17 3808	2NE 964 169-021	2.100
E12 7114	9EL 997 469-001	2.69	E17 0071	2VP 345 900-271	2.26, 2.300	E17 3808	2NE 964 169-027	2.100
E12 7122	9EL 990 267-001	1.73	E17 0071	2VP 345 900-331	2.27, 2.301	E17 3808	2NE 964 169-227	2.100
E12 7133	2SD 996 030-021	2.54	E17 0071	2VP 345 900-341	2.27, 2.301	E17 3809	2NE 964 169-521	2.97
E12 7133	2SE 996 030-011	2.54	E17 0071	2VP 345 900-401	2.25, 2.299	E17 3809	2NE 964 169-527	2.97
E12 7133	9EL 990 142-001	2.54	E17 0071	2VP 345 900-411	2.25, 2.299	E17 3810	2NE 964 169-341	2.96
E12 7136	2SD 001 685-307	2.61	E17 0071	2VP 345 900-421	2.25, 2.299	E17 402	8RA 342 014-157	2.256
E12 7146	2SD 001 685-211	2.62, 2.308	E17 0071	2VP 345 900-431	2.25, 2.299	E17 408	2SE 004 623-001	2.54, 2.56
E12 7146	2SD 001 685-218	2.62	E17 0071	2VP 345 900-441	2.26, 2.300	E17 408	2SE 004 623-007	2.54
E12 7146	2SD 001 685-231	2.62, 2.308	E17 0071	2VP 345 900-451	2.26, 2.300	E17 408	2XL 004 762-001	2.56
E12 7146	2SD 001 685-232	2.62	E17 0071	2VP 345 900-461	2.26, 2.300	E17 408	9EL 129 519-001	2.54, 2.56
E12 7146	2SD 001 685-277	2.62	E17 0071	2VP 345 900-471	2.26, 2.300	E17 418	2VB 341 032-111	2.46
E12 7146	2SD 001 685-317	2.62	E17 0102	2SD 001 685-347	2.61, 2.308	E17 418	2VB 341 032-117	2.46
E12 7146	2SE 001 685-201	2.62, 2.308	E17 0202	2PS 964 295-051	2.153	E17 418	2VB 341 032-121	2.46
E12 7146	2SE 001 685-221	2.62, 2.308	E17 0202	2PS 964 295-057	2.153	E17 418	2VB 341 032-127	2.46
E12 7146	2SE 001 685-227	2.62	E17 0202	2PS 964 295-061	2.153	E17 418	2VB 341 032-141	2.46
E12 7146	9EL 113 324-001	2.62, 2.308	E17 0202	2PS 964 295-067	2.153	E17 418	2VB 341 032-547	2.46
E12 7154	2DA 996 012-041	2.120	E17 0202	2PS 964 295-071	2.153	E17 418	2VP 341 032-537	2.46
E12 7176	2SD 001 685-307	2.61	E17 0202	2PS 964 295-077	2.153	E17 630	2SD 004 623-028	2.54
E12989	2RL 010 743-061	3.35	E17 0202	2PS 964 295-081	2.153	E17 630	2SE 004 623-001	2.54, 2.56
E13 0515	2XS 008 078-001	2.191, 2.324	E17 0202	2PS 964 295-347	2.153	E17 630	2SE 004 623-007	2.54
E13 0515	2XS 008 078-007	2.191	E17 0202	2PS 964 295-357	2.153	E17 630	2XL 004 762-001	2.56
E13 0515	2XS 008 078-011	2.191	E17 02379	8RA 002 023-001	2.258	E17 630	9EL 129 519-001	2.54, 2.56
E13 2J6	8GH 007 643-121	4.12	E17 02379	8RA 002 023-011	2.258	E17 648	2BA 964 169-011	2.100
E13 9385	2SD 006 040-031	2.33	E17 02379	8RA 002 023-021	2.258	E17 648	2BA 964 169-017	2.100
E13 9385	2SD 006 040-037	2.33	E17 0301	2PG 964 295-111	2.154	E17 648	9EL 964 527-001	2.100
E13 9385	2SD 006 040-041	2.33	E17 0301	2PG 964 295-117	2.154	E17 651	2BM 964 295-041	2.153
E13 9385	2SD 006 040-131	2.34	E17 0301	2PG 964 295-121	2.154	E17 651	2BM 964 295-047	2.153
E13 9385	2SD 006 040-137	2.34	E17 0301	2PG 964 295-127	2.154	E17 652	2BA 344 169-191	2.95
E13 9385	2SD 006 040-141	2.34	E17 0302	2TM 964 295-091	2.153	E17 652	2BA 964 169-311	2.95
E13 9385	2SD 006 040-147	2.34	E17 0302	2TM 964 295-097	2.153	E17 653	2BA 964 169-501	2.97
E13 9385	2SD 006 040-161	2.33	E17 0302	2TM 964 295-101	2.153	E17 653	2BA 964 169-507	2.97
E13 9385	2SD 006 040-167	2.33	E17 0302	2TM 964 295-107	2.153	E17 763	2SD 004 623-028	2.54
E13 9385	2SE 006 040-011	2.33	E17 0303	2VA 343 640-071	2.31	E17 763	2SE 004 623-001	2.54, 2.56
E13 9385	2VA 006 040-071	2.32	E17 0303	2VA 343 640-077	2.31	E17 763	2SE 004 623-007	2.54
E13 9385	2VA 006 040-077	2.32	E17 0303	2VA 343 640-117	2.30	E17 763	2XL 004 762-001	2.56
E13 9385	2VA 006 040-291	2.33	E17 0303	2VA 343 640-131	2.30	E17 763	9EL 129 519-001	2.54, 2.56
E13 9385	2VB 006 040-051	2.32	E17 0303	2VA 343 640-137	2.30	E17 787	2TM 006 717-047	2.138
E13 9385	2VP 006 040-111	2.32	E17 0303	2VA 343 640-207	2.30	E17 789	2PG 006 717-021	2.138
E13 9385	2VP 006 040-117	2.32	E17 0303	2VB 343 640-011	2.31	E17 789	2PG 006 717-027	2.138
E13 9385	2VP 006 040-121	2.32	E17 0303	2VB 343 640-127	2.30	E17 789	9EL 141 135-021	2.138
E13 9385	2VP 006 040-127	2.32	E17 0303	2VB 343 640-297	2.30	E17 795	2DA 007 428-001	2.202
E13 9385	2VP 006 040-301	2.33	E17 0303	2VP 343 640-021	2.31	E17 795	2DA 007 428-007	2.202
E13 9385	2VP 006 040-307	2.33	E17 0303	2VP 343 640-027	2.31	E17 801	9EL 964 289-001	2.188
E13 9385	2VP 006 040-351	2.33	E17 0303	2VP 343 640-031	2.31	E17 801	9EL 964 290-001	2.188
E13 9385	2VP 006 040-357	2.33	E17 0303	2VP 343 640-041	2.30	E17 803	2PF 006 717-011	2.138
E13 9385	2VP 006 040-397	2.32	E17 0303	2VP 343 640-047	2.30	E17 803	9EL 141 135-011	2.138
E13 9385	2VP 006 040-407	2.32	E17 0303	2VP 343 640-051	2.30	E17 804	2SA 006 717-001	2.138
E13 9385	2VP 006 040-437	2.32	E17 0303	2VP 343 640-057	2.30	E17 804	2SA 006 717-007	2.138
E13 9385	2VP 006 040-447	2.32	E17 0303	2VP 343 640-081	2.30	E17 804	9EL 141 135-001	2.138
E13 9385	2VP 006 040-477	2.32	E17 0303	2VP 343 640-087	2.30	E17 805	2XS 963 959-031	2.143
E13 9385	2VP 006 040-487	2.32	E17 0303	2VP 343 640-091	2.30	E17 805	2XS 963 959-037	2.143
E13 9385	9EL 136 819-011	2.33	E17 0303	2VP 343 640-097	2.30	E17 805	9EL 963 984-001	2.143
E13 9385	9EL 136 819-031	2.32	E17 0303	2VP 343 640-247	2.29	E17 808	2DA 964 169-001	2.100
E13 9385	9EL 136 819-041	2.34	E17 0303	2VP 343 640-267	2.29	E17 808	2DA 964 169-007	2.100
E13 9385	9EL 136 825-001	2.32	E17 0303	2VP 343 640-277	2.29	E17 808	9EL 964 526-001	2.100
E13 9385	9EL 136 825-011	2.32	E17 0303	9EL 343 142-001	2.29-2.31	E17 810	2SA 964 169-091	2.98
E13 9385	9EL 136 833-001	2.33	E17 0303	9EL 343 143-001	2.29-2.31	E17 810	2SA 964 169-097	2.98
E13 9385	9EL 136 833-011	2.32	E17 0303	9EL 343 143-011	2.30-2.31	E17 810	2SA 964 169-277	2.98
E13 9385	9EL 137 792-011	2.33	E17 0501	2SD 343 440-017	2.41	E17 811	2PF 964 295-021	2.154
E13 9385	9EL 137 792-031	2.34	E17 0501	2SD 343 440-047	2.41	E17 811	2PF 964 295-027	2.154
E13 9401	2XS 950 071-031	2.187, 2.323	E17 0501	2SK 343 440-027	2.41	E17 812	2XS 964 295-031	2.153
E13 9401	2XS 955 031-001	2.187, 2.323	E17 0501	2SK 343 440-037	2.41	E17 812	2XS 964 295-037	2.153
E13 9401	2XS 955 031-017	2.187, 2.323	E17 20050	2SD 344 685-051	2.61, 2.308	E17 814	2SB 964 169-301	2.95
E13 9401	2XS 955 232-001	2.187, 2.323	E17 2309	2ZR 006 609-081	2.195	E17 814	2SB 964 169-307	2.95
E13 9401	2XS 955 232-017	2.187	E17 2309	2ZR 006 609-087	2.195	E17 817	2PF 964 295-257	2.154
E13 9401	9EL 950 315-031	2.187, 2.323	E17 2309	2ZR 006 609-171	2.195	E17 822	2SB 343 400-317	2.108
E13 9401	9EL 950 315-061	2.187, 2.323	E17 2311	2ZR 344 169-157	2.102	E17 822	2SB 343 400-327	2.108
E13 9428	2XS 955 260-001	2.188	E17 2311	2ZR 344 169-167	2.102	E17 9101	2SB 004 460-061	2.37
E13 9428	2XS 955 260-007	2.188	E17 2311	2ZR 964 169-031	2.102	E17 9301	2SD 004 460-001	2.37
E13 9428	9EL 964 289-001	2.188	E17 2311	2ZR 964 169-037	2.102			

Type approval numbers



Type approval no.	Part no.	Page	Type approval no.	Part no.	Page	Type approval no.	Part no.	Page
E17 9701	2VP 007 907-047	2.19	E24 0032	2KA 012 271-037	2.183, 2.326	E24 5862	2PT 980 850-801	2.178
E17 9701	9EL 150 965-001	2.19	E24 0032	2KA 012 271-047	2.183, 2.326	E24 5862	2PT 980 850-851	2.178
E17 9701	9EL 150 966-001	2.19	E24 0032	2KA 012 271-057	2.183, 2.326	E24 5863	2PT 980 860-001	2.179
E17 9704	2PS 963 959-001	2.143, 2.270	E24 0032	2KA 012 271-067	2.183, 2.326	E24 5863	2PT 980 860-501	2.179
E17 9704	2PS 963 959-007	2.143	E24 0032	2KA 012 271-077	2.183, 2.326	E24 5863	2PT 980 860-557	2.179
E17 9704	2PS 963 959-011	2.143, 2.270	E24 0032	2KA 012 271-087	2.183, 2.326	E24 5863	2PT 980 860-801	2.179
E17 9704	2PS 963 959-017	2.143	E24 0032	2KA 012 271-237	2.183, 2.326	E24 5863	2PT 980 860-851	2.179
E17 9705	2PG 963 959-021	2.143	E24 0032	2KA 012 271-277	2.183, 2.326	E24 5864	2PT 980 789-051	2.174
E17 9705	2PG 963 959-027	2.143	E24 004	2PS 959 788-002	2.156	E24 5864	2PT 980 789-061	2.174
E17 9705	9EL 963 983-001	2.143	E24 0051	2PF 959 570-202	2.167, 2.263	E24 5864	2PT 980 789-251	2.174
E17 9801	2BN 344 169-097	2.101	E24 0051	2PF 959 570-207	2.167	E24 5864	2PT 980 789-261	2.174
E17 9801	2BN 344 169-107	2.101	E24 0051	2PF 959 570-212	2.167, 2.263	E24 5864	2PT 980 789-851	2.174
E17 9801	2BN 964 169-051	2.101	E24 0051	2PF 959 570-217	2.167	E24 5864	2PT 980 789-861	2.174
E17 9801	2BN 964 169-057	2.101	E24 0054	2PF 959 590-202	2.155, 2.263	E24 5864	2PT 980 789-901	2.174
E17 9801	2BN 964 169-247	2.101	E24 0054	2PF 959 590-207	2.155	E24 5864	2PT 980 789-911	2.174
E17 9801	2BN 964 169-777	2.101	E24 0054	2PF 959 590-212	2.155, 2.263	E24 5869	2BA 980 888-311	2.140
E17 9801	2BN 964 169-787	2.101	E24 0054	2PF 959 590-217	2.155	E24 5869	2BA 980 888-411	2.140
E17 9801	2NE 344 169-067	2.100	E24 0054	2PF 959 590-218	2.155	E24 5869	2PT 980 880-811	2.141
E17 9801	2NE 344 169-117	2.100	E24 0054	2PF 959 590-237	2.155	E24 5869	2PT 980 880-861	2.141
E17 9801	9EL 964 531-001	2.101	E24 0054	2PF 959 590-257	2.155	E24 5875	2PT 980 970-021	2.177
E17 9802	2BE 964 169-071	2.102	E24 0066	2BM 340 825-201	2.265	E24 5875	2PT 980 970-521	2.177
E17 9802	2BE 964 169-077	2.102	E24 0066	2BM 340 825-207	2.265	E24 5875	2PT 980 970-821	2.177
E17 9802	9EL 964 533-001	2.102	E24 0066	2BM 340 825-211	2.265	E24 5875	2PT 980 970-871	2.177
E17 9803	2SW 964 169-081	2.100	E24 0066	2BM 340 825-217	2.265	E24 5876	2NR 344 169-441	2.96, 2.315
E17 9803	2SW 964 169-087	2.100	E24 0066	2BM 340 825-301	2.265	E24 5876	2NR 344 169-461	2.96, 2.315
E17 9803	9EL 964 534-001	2.100	E24 0066	2BM 340 825-307	2.265	E24 5878	2PF 959 855-201	2.157
E17 9804	2BA 964 169-041	2.101	E24 0066	2BM 340 825-311	2.265	E24 5878	2PF 959 855-207	2.157
E17 9804	2BA 964 169-047	2.101	E24 0066	2BM 340 825-317	2.265	E24 5878	2PF 959 855-241	2.157
E17 9804	9EL 964 530-001	2.101	E24 0087	2DA 980 887-311	2.140	E24 5878	2PF 959 855-247	2.157
E17 9805	2SB 964 169-287	2.99	E24 0087	2DA 980 887-411	2.140	E24 5878	2PF 959 855-251	2.157
E17 9805	2SB 964 169-531	2.97	E24 0958	2SK 980 603-503	2.64, 2.302	E24 5878	2PF 959 855-257	2.157
E17 9805	2SB 964 169-537	2.97	E24 0958	2SK 980 615-001	2.64, 2.302	E24 5878	2XS 959 855-401	2.157
E17 9805	2SB 964 169-677	2.97	E24 25887	2VA 012 497-001	2.59	E24 5878	2XS 959 855-407	2.157
E17 9805	2SB 964 169-717	2.99	E24 25887	2VA 012 497-011	2.59	E24 5878	2XS 959 855-447	2.157
E17 9805	2TA 344 169-077	2.99	E24 25887	2VA 012 497-051	2.59	E24 5878	2XS 959 855-447	2.157
E17 9805	2TA 344 169-087	2.99	E24 25887	2VA 012 497-061	2.59	E24 5878	2XS 959 855-457	2.157
E17 9805	2TA 964 169-061	2.99	E24 25887	2VA 012 497-101	2.59	E24 5878	2XS 959 855-457	2.157
E17 9805	2TA 964 169-067	2.99	E24 25887	2VA 012 497-111	2.59	E24 5878	2XT 959 510-397	2.157
E17 9805	2TA 964 169-767	2.99	E24 25887	2VA 012 497-151	2.59	E24 5878	2XT 959 510-427	2.157
E17 9805	2TA 964 169-797	2.99	E24 25887	2VA 012 497-161	2.59	E24 5878	2XT 959 510-467	2.157
E17 9805	9EL 964 532-001	2.99	E24 5850	2BA 980 607-201	2.66, 2.304	E24 5878	2XT 959 510-657	2.157
E17 9806	2PG 964 295-011	2.154	E24 5850	2BA 980 607-701	2.66, 2.304	E24 5878	2XT 980 855-111	2.157
E17 9806	2PG 964 295-017	2.154	E24 5850	2SB 980 606-201	2.65, 2.303	E24 5878	2XT 980 855-117	2.157
E17 9807	2PS 964 295-001	2.153	E24 5850	2SB 980 606-701	2.65, 2.303	E24 5878	2XT 980 855-411	2.157
E17 9807	2PS 964 295-007	2.153	E24 5850	2VB 980 720-407	2.58, 2.305	E24 5878	2XT 980 855-417	2.157
E17 9823	2SD 964 169-401	2.95	E24 5850	2ZR 980 605-201	2.66, 2.304	E24 5879	2VP 345 900-011	2.27, 2.301
E17 9823	2SD 964 169-411	2.95	E24 5850	2ZR 980 605-701	2.66, 2.304	E24 5879	2VP 345 900-021	2.27, 2.301
E17 9823	2SD 964 169-421	2.95	E24 5852	2PT 010 458-701	2.172	E24 5879	2VP 345 900-091	2.27, 2.301
E17 9803	2SD 344 169-137	2.98	E24 5852	2PT 010 458-711	2.172	E24 5879	2VP 345 900-101	2.27, 2.301
E17 9803	2SD 344 169-147	2.98	E24 5852	2PT 010 458-721	2.172	E24 5879	2VP 345 900-131	2.27, 2.301
E17 9803	2SD 344 169-237	2.98	E24 5852	2PT 010 458-731	2.172	E24 5879	2VP 345 900-141	2.27, 2.301
E17 9803	2SD 344 169-247	2.98	E24 5852	2PT 010 458-741	2.173	E24 5879	2VP 345 900-201	2.25, 2.299
E17 9803	2SD 964 169-111	2.98	E24 5852	2PT 010 458-751	2.173	E24 5879	2VP 345 900-211	2.25, 2.299
E17 9803	2SD 964 169-117	2.98	E24 5852	2PT 010 458-761	2.173	E24 5879	2VP 345 900-221	2.25, 2.299
E17 9803	9EL 964 536-001	2.98	E24 5852	2PT 010 458-771	2.173	E24 5879	2VP 345 900-231	2.25, 2.299
E2 164	2SD 003 409-327	2.45	E24 5852	2PT 177 696-701	2.172	E24 5879	2VP 345 900-241	2.26, 2.300
E2 167	9EL 119 544-001	2.126-2.127, 2.129-2.130	E24 5852	2PT 177 696-711	2.172	E24 5879	2VP 345 900-251	2.26, 2.300
E2 32764	9EL 119 544-101	2.129	E24 5852	2PT 177 696-721	2.172	E24 5879	2VP 345 900-261	2.26, 2.300
E2 7078	2VD 008 789-011	2.20	E24 5852	2PT 177 696-731	2.173	E24 5879	2VP 345 900-271	2.26, 2.300
E2 7078	2VP 008 789-021	2.20	E24 5852	2PT 177 696-761	2.173	E24 5879	2VP 345 900-331	2.27, 2.301
E2 7078	2VP 008 789-041	2.20	E24 5852	2PT 177 696-771	2.173	E24 5879	2VP 345 900-341	2.27, 2.301
E2 7078	2VP 008 789-051	2.20	E24 5852	5DS 010 668-701	2.172-2.173	E24 5879	2VP 345 900-401	2.25, 2.299
E2 7078	2VP 008 789-071	2.20	E24 5852	5DS 010 668-711	2.172-2.173	E24 5879	2VP 345 900-411	2.25, 2.299
E2 88072	9EL 856 415-001	3.26	E24 5854	2BE 980 690-101	2.218	E24 5879	2VP 345 900-421	2.25, 2.299
E2 88072	9EL 856 416-001	3.26-3.27	E24 5854	2BE 980 690-301	2.90, 2.309	E24 5879	2VP 345 900-431	2.25, 2.299
E2 88072	9EL 856 416-011	3.27	E24 5854	2PT 980 690-601	2.175	E24 5879	2VP 345 900-441	2.26, 2.300
E2 88072	9EL 856 417-001	3.26	E24 5854	2PT 980 691-601	2.175	E24 5879	2VP 345 900-451	2.26, 2.300
E2 88072	9EL 856 418-001	3.26-3.27	E24 5855	2VP 340 960-011	2.271	E24 5879	2VP 345 900-461	2.26, 2.300
E2 88072	9EL 856 418-011	3.27	E24 5855	2VP 340 960-021	2.271	E24 5879	2VP 345 900-471	2.26, 2.300
E2 88072	9EL 856 418-017	3.27	E24 5855	2VP 340 960-111	2.271	E24 5880	2VP 345 900-011	2.27, 2.301
E2 92031	8RA 003 326-031	2.257	E24 5855	2VP 340 960-121	2.271	E24 5880	2VP 345 900-021	2.27, 2.301
E2 92031	8RA 003 326-041	2.257	E24 5855	2VP 340 960-271	2.271	E24 5880	2VP 345 900-091	2.27, 2.301
E2 92031	8RA 003 326-051	2.257	E24 5855	2VP 340 960-281	2.271	E24 5880	2VP 345 900-101	2.27, 2.301
E2 92031	8RA 003 326-931	2.257	E24 5855	2VP 340 961-011	2.272	E24 5880	2VP 345 900-131	2.27, 2.301
E24 0001	2PT 980 680-001	2.176	E24 5855	2VP 340 961-021	2.272	E24 5880	2VP 345 900-141	2.27, 2.301
E24 0001	2PT 980 680-101	2.177	E24 5855	2VP 340 961-031	2.272	E24 5880	2VP 345 900-201	2.25, 2.299
E24 0001	2PT 980 680-501	2.176	E24 5855	2VP 340 961-041	2.272	E24 5880	2VP 345 900-211	2.25, 2.299
E24 0001	2PT 980 680-601	2.177	E24 5855	2VP 340 961-111	2.272-2.273	E24 5880	2VP 345 900-221	2.25, 2.299
E24 0001	2PT 980 680-801	2.176	E24 5855	2VP 340 961-121	2.272-2.273	E24 5880	2VP 345 900-231	2.25, 2.299
E24 0001	2PT 980 680-821	2.177	E24 5855	2VP 340 961-131	2.274	E24 5880	2VP 345 900-241	2.26, 2.300
E24 0001	2PT 980 680-851	2.176	E24 5855	2VP 340 961-141	2.274	E24 5880	2VP 345 900-251	2.26, 2.300
E24 0008	1FJ 958 040-001	1.34	E24 5855	2VP 340 961-211	2.274	E24 5880	2VP 345 900-261	2.26, 2.300
E24 0008	1FJ 958 040-051	1.34	E24 5855	2VP 340 961-221	2.274	E24 5880	2VP 345 900-271	2.26, 2.300
E24 0010	2NE 980 889-501	2.141	E24 5855	2VP 340 961-411	2.275	E24 5880	2VP 345 900-331	2.27, 2.301
E24 0010	2NE 980 889-601	2.141	E24 5855	2VP 340 961-421	2.275	E24 5880	2VP 345 900-401	2.25, 2.299
E24 0016	2ZR 012 456-001	2.198	E24 5855	2VP 340 961-431	2.275	E24 5880	2VP 345 900-411	2.25, 2.299
E24 0016	2ZR 012 456-007	2.198	E24 5856	2VP 340 961-441	2.275	E24 5880	2VP 345 900-421	2.25, 2.299
E24 0016	2ZR 012 456-011	2.198	E24 5856	2VP 340 960-011	2.271	E24 5880	2VP 345 900-431	2.25, 2.299
E24 0016	2ZR 012 456-017	2.198	E24 5856	2VP 340 960-021	2.271	E24 5880	2VP 345 900-441	2.26, 2.300
E24 0016	2ZR 012 456-021	2.198	E24 5856	2VP 340 960-111	2.271	E24 5880	2VP 345 900-451	2.26, 2.300
E24 0016	2ZR 012 456-027	2.198	E24 5856	2VP 340 960-121	2.271	E24 5880	2VP 345 900-461	2.26, 2.300
E24 0016	2ZR 012 456-031	2.198	E24 5856	2VP 340 960-271	2.271	E2		



Type approval numbers

Type approval no.	Part no.	Page	Type approval no.	Part no.	Page	Type approval no.	Part no.	Page
E24 5881	2PS 345 600-177	2.145	E4 10208	2SB 959 821-601	2.103, 2.306	E4 10909	2ZR 302 252-047	2.88
E24 5881	2PS 345 600-197	2.145	E4 10208	2ZR 959 820-601	2.103, 2.306	E4 1098	1A3 996 162-607	1.72
E24 5881	2TM 345 600-307	2.145	E4 10211	2VP 340 830-101	2.280	E4 11371	2PF 340 825-001	2.263
E24 5881	2TM 345 600-311	2.145	E4 10211	2VP 340 830-111	2.280	E4 11372	1EE 996 174-211	1.80
E24 5881	2TM 345 600-317	2.145, 2.317	E4 10211	2VP 340 930-101	2.280	E4 11372	1EE 996 174-431	1.81
E24 5884	2VD 012 381-011	2.14, 2.295	E4 10211	2VP 340 930-111	2.280	E4 11372	1EE 996 174-441	1.81
E24 5884	2VD 012 381-031	2.14, 2.295	E4 10211	2VP 340 931-101	2.280	E4 11386	2VP 340 932-001	2.281
E24 5884	2VD 012 381-211	2.16, 2.297	E4 10211	2VP 340 931-111	2.280	E4 11386	2VP 340 932-011	2.281
E24 5884	2VD 012 381-251	2.16, 2.297	E4 10211	2XS 302 240-031	2.322	E4 11386	2VP 340 934-101	2.281
E24 5884	2VD 012 381-261	2.297	E4 10211	2XS 302 240-051	2.322	E4 11386	2VP 340 934-111	2.281
E24 5884	2VD 012 381-281	2.297	E4 10211	2XS 302 241-071	2.322	E4 11386	9XX 340 173-801	2.282
E24 5884	2VD 012 381-311	2.15, 2.296	E4 10211	2XS 302 241-081	2.322	E4 11391	2NE 959 011-501	2.91, 2.310
E24 5884	2VD 012 381-351	2.15, 2.296	E4 10211	2XS 340 447-001	2.321	E4 11391	2NE 959 011-507	2.91, 2.310
E24 5884	2VP 012 381-021	2.14, 2.295	E4 10211	2XS 340 447-021	2.321	E4 11391	2NE 959 011-527	2.91
E24 5884	2VP 012 381-041	2.14, 2.295	E4 10211	2XS 340 448-001	2.320	E4 11391	2ZR 959 010-501	2.91, 2.310
E24 5884	2VP 012 381-051	2.14, 2.295	E4 10211	2XS 340 448-011	2.320	E4 11391	2ZR 959 010-507	2.91, 2.310
E24 5884	2VP 012 381-061	2.14, 2.295	E4 10211	2XS 340 827-001	2.321	E4 11392	2VP 340 934-101	2.281
E24 5884	2VP 012 381-081	2.14, 2.295	E4 10211	2XS 340 827-011	2.321	E4 11392	2VP 340 934-111	2.281
E24 5884	2VP 012 381-221	2.16, 2.297	E4 10211	2XS 340 827-121	2.321	E4 11392	2VP 340 940-101	2.283
E24 5884	2VP 012 381-241	2.16, 2.297	E4 10211	2XS 340 827-131	2.321	E4 11392	2VP 340 940-111	2.283
E24 5884	2VP 012 381-321	2.15, 2.296	E4 10215	2BA 965 039-021	2.87	E4 11392	2XS 011 744-011	2.271-2.272, 2.274-2.275, 2.318
E24 5884	2VP 012 381-341	2.15, 2.296	E4 10215	2BA 965 039-027	2.87	E4 11392	2XS 011 744-021	2.271-2.272, 2.274-2.275, 2.318
E24 5884	2VP 012 381-361	2.15, 2.296	E4 10215	2BA 965 039-061	2.87	E4 11392	2XS 011 744-031	2.318
E24 5884	2VP 012 381-381	2.15, 2.296	E4 10215	2BA 965 039-067	2.87	E4 11392	2XS 011 744-041	2.318
E24 5888	2VP 345 900-341	2.27, 2.301	E4 10215	2BA 965 039-101	2.87	E4 11392	2XS 011 744-051	2.318
E24 5890	2BA 980 888-511	2.140	E4 10215	2BA 965 039-107	2.87	E4 11392	2XS 011 744-061	2.318
E24 5890	2BA 980 888-611	2.140	E4 10215	2BA 965 039-147	2.87	E4 11392	2XS 011 744-071	2.318
E24 5891	2BA 980 888-011	2.140	E4 10215	2DA 965 039-091	2.86	E4 11392	2XS 011 744-081	2.318
E24 5891	2BA 980 888-211	2.140	E4 10215	2DA 965 039-317	2.86	E4 11392	2XS 011 744-101	2.318
E24 5891	2SB 980 887-011	2.140	E4 10215	2NE 965 039-111	2.86	E4 11392	2XS 011 744-111	2.318
E24 5891	2SB 980 887-211	2.140	E4 10215	2NE 965 039-327	2.86	E4 11392	2XS 011 744-161	2.281, 2.283, 2.318
E24 5894	2SK 980 602-501	2.64, 2.302	E4 10215	2PF 965 039-071	2.86	E4 11392	2XS 011 744-171	2.281, 2.283, 2.318
E24 5894	2SK 980 613-501	2.64, 2.302	E4 10215	2PF 965 039-151	2.86	E4 11392	2XS 011 768-001	2.319
E3 3968	1FO 996 376-181	1.10	E4 10215	2PT 965 039-171	2.87	E4 11392	2XS 011 768-011	2.319
E3 6917	1FO 996 376-181	1.10	E4 10215	2SA 965 039-081	2.86	E4 11392	2XS 011 768-021	2.319
E4 0002	2PS 002 727-001	2.144	E4 10215	2SA 965 039-087	2.86	E4 11392	2XS 011 768-031	2.319
E4 0002	2PS 004 361-001	2.144	E4 10215	2SA 965 039-307	2.86	E4 11392	2XS 011 768-061	2.319
E4 0002	2PS 004 361-007	2.144	E4 10215	2SA 965 039-351	2.86	E4 11392	2XS 011 768-071	2.319
E4 0003	2PS 002 727-001	2.144	E4 10215	2SB 965 039-051	2.86	E4 11392	2XS 011 769-011	2.320
E4 0003	2PS 004 361-001	2.144	E4 10215	2SB 965 039-057	2.86	E4 11392	2XS 011 769-021	2.320
E4 0003	2PS 004 361-007	2.144	E4 10215	2SB 965 039-131	2.86	E4 11392	2XS 011 769-051	2.320
E4 0004	1BA 996 261-021	1.85	E4 10215	2ZR 965 039-041	2.87	E4 11392	2XS 011 769-061	2.320
E4 0004	1BA 996 261-197	1.85	E4 10215	2ZR 965 039-047	2.87	E4 11392	2XS 011 769-091	2.320
E4 0004	2PS 962 964-012	2.137	E4 10215	2ZR 965 039-121	2.87	E4 11392	2XS 340 447-001	2.321
E4 0004	2PS 962 964-018	2.137	E4 10215	2ZR 965 039-127	2.87	E4 11392	2XS 340 447-021	2.321
E4 0004	2PS 962 964-031	2.137	E4 10215	2ZR 965 039-337	2.87	E4 11392	2XS 340 448-001	2.320
E4 0004	2PS 962 964-037	2.137	E4 10217	2VA 341 419-077	2.44	E4 11392	2XS 340 448-011	2.320
E4 1	1A6 002 395-031	1.60	E4 10217	2VA 341 419-097	2.44	E4 11779	2VP 340 940-101	2.283
E4 1	1A6 002 395-071	1.60	E4 10217	2VA 341 419-167	2.44	E4 11779	2VP 340 940-111	2.283
E4 1	1A6 002 395-077	1.60	E4 10217	2VA 341 419-187	2.44	E4 11779	2VP 340 942-001	2.282
E4 1	1A6 002 395-387	1.60	E4 10217	2VA 341 419-087	2.44	E4 11779	2VP 340 942-011	2.282
E4 1	1A6 002 395-821	1.60	E4 10217	2VP 341 419-107	2.44	E4 11779	2VP 340 942-101	2.283
E4 10148	2VA 998 232-547	2.47	E4 10217	2VP 341 419-157	2.44	E4 11779	2VP 340 942-111	2.283
E4 10148	2VB 998 232-537	2.47	E4 10218	2VP 340 830-001	2.279	E4 11785	2SD 343 390-011	2.106
E4 10151	2BA 008 805-051	2.132	E4 10218	2VP 340 830-011	2.279	E4 11785	2SD 343 390-401	2.105
E4 10151	2BA 008 805-057	2.132	E4 10218	2VP 340 830-021	2.279	E4 11785	2SD 343 390-407	2.105
E4 10151	2BA 008 805-187	2.132	E4 10218	2VP 340 830-031	2.279	E4 11785	2SD 343 390-417	2.105
E4 10151	2BA 008 805-211	2.131	E4 10218	2VP 340 830-101	2.280	E4 11785	2SD 343 390-707	2.105
E4 10151	2BA 008 805-257	2.132	E4 10218	2VP 340 830-111	2.280	E4 12371	2NE 344 200-061	2.92, 2.314
E4 10151	2DA 008 805-011	2.132	E4 10218	2VP 340 831-001	2.278	E4 12371	2SD 344 200-001	2.91, 2.312
E4 10151	2DA 008 805-017	2.132	E4 10218	2VP 340 831-011	2.278	E4 12371	2SD 344 200-071	2.91, 2.312
E4 10151	2NE 008 805-031	2.132	E4 10218	2VP 340 888-001	2.12, 2.292	E4 12371	2SD 344 200-077	2.91
E4 10151	2NE 008 805-037	2.132	E4 10218	2VP 340 888-007	2.12	E4 12371	2SD 344 200-311	2.93, 2.312
E4 10151	2SA 008 805-001	2.132	E4 10218	2VP 340 888-011	2.12, 2.292	E4 12371	2ZR 344 200-051	2.93, 2.315
E4 10151	2SA 008 805-007	2.132	E4 10218	2VP 340 888-017	2.12	E4 12373	2BA 959 011-301	2.90, 2.309
E4 10151	2SB 008 805-021	2.132	E4 10218	2VP 340 930-001	2.279	E4 12373	2BA 959 011-307	2.90, 2.309
E4 10151	2SB 008 805-027	2.132	E4 10218	2VP 340 930-011	2.279	E4 12373	2SB 959 010-001	2.90, 2.309
E4 10151	2SB 008 805-201	2.131	E4 10218	2VP 340 930-021	2.279	E4 12373	2SB 959 010-301	2.90, 2.309
E4 10151	2SB 008 805-237	2.132	E4 10218	2VP 340 930-031	2.279	E4 12373	2SB 959 010-307	2.90, 2.309
E4 10151	2ZR 008 805-041	2.132	E4 10218	2VP 340 930-101	2.280	E4 12373	2SB 959 010-317	2.90
E4 10151	2ZR 008 805-047	2.132	E4 10218	2VP 340 930-111	2.280	E4 12390	2BA 009 001-411	2.81
E4 10151	2ZR 008 805-247	2.132	E4 10218	2VP 340 931-001	2.278	E4 12390	2BA 009 001-431	2.81
E4 10162	2VA 998 233-271	2.51	E4 10218	2VP 340 931-011	2.278	E4 12390	2BA 009 001-511	2.81
E4 10162	2VA 998 233-357	2.51	E4 10218	2VP 340 931-101	2.280	E4 12390	2BA 009 001-531	2.81
E4 10162	2VA 998 233-367	2.51	E4 10218	2VP 340 931-111	2.280	E4 12390	2PF 009 001-421	2.81
E4 10162	2VP 998 233-281	2.51	E4 10218	2VP 340 932-001	2.281	E4 12390	2PF 009 001-521	2.81
E4 10162	9EL 990 633-031	2.51	E4 10218	2VP 340 932-011	2.281	E4 12390	2SB 009 001-401	2.81
E4 10162	9EL 990 633-041	2.51	E4 10218	2VP 340 934-101	2.281	E4 12390	2SB 009 001-501	2.81
E4 10176	2SD 959 050-401	2.64, 2.302	E4 10218	2VP 340 934-111	2.281	E4 12390	2SD 010 546-127	2.82
E4 10198	1A3 996 162-071	1.57	E4 10219	2VP 340 830-021	2.279	E4 12390	2SD 010 546-137	2.82
E4 10198	1A3 996 162-321	1.57	E4 10219	2VP 340 830-031	2.279	E4 12393	2SD 343 910-001	2.52
E4 10198	1A3 996 162-381	1.57	E4 10219	2VP 340 888-001	2.12, 2.292	E4 12393	2SD 343 910-017	2.52
E4 10198	1E3 996 160-637	1.71	E4 10219	2VP 340 888-007	2.12	E4 1247	2SK 005 883-011	2.18
E4 10198	1E3 996 160-647	1.71	E4 10219	2VP 340 888-011	2.12, 2.292	E4 1247	2SK 005 883-021	2.18
E4 10198	1E3 996 160-671	1.71	E4 10219	2VP 340 888-017	2.12	E4 1247	2SL 005 883-031	2.18
E4 10198	1E3 996 160-681	1.71	E4 10219	2VP 340 930-021	2.279	E4 1247	2SL 005 883-041	2.18
E4 1								

Type approval numbers



Type approval no.	Part no.	Page	Type approval no.	Part no.	Page	Type approval no.	Part no.	Page
E4 14198	2NE 344 200-091	2,92, 2,314	E4 2899	2XS 959 855-447	2,157	E4 3880	9EL 122 772-001	2,22-2,23, 2,287
E4 14198	2NE 344 200-097	2,92	E4 2899	2XS 959 855-451	2,157	E4 3880	9GP 003 995-801	2,21-2,23, 2,36, 2,285, 2,287
E4 14198	2SD 344 200-001	2,91, 2,312	E4 2899	2XS 959 855-457	2,157	E4 3917	2NE 009 001-021	2,83
E4 14198	2SD 344 200-071	2,91, 2,312	E4 2899	2XT 959 510-397	2,157	E4 3917	2NE 009 001-027	2,83
E4 14198	2ZR 344 200-051	2,93, 2,315	E4 2899	2XT 959 510-427	2,157	E4 3917	2NE 009 001-127	2,83
E4 14198	2ZR 344 200-057	2,93	E4 2899	2XT 959 510-467	2,157	E4 3919	2NE 343 130-031	2,111
E4 14800	2PG 357 009-021	2,352	E4 2899	2XT 959 510-657	2,157	E4 3919	2NE 343 130-037	2,111
E4 14800	2PG 357 009-121	2,352	E4 2899	2XT 980 855-111	2,157	E4 3919	2NE 343 130-177	2,108
E4 14801	2TM 357 009-011	2,352	E4 2899	2XT 980 855-117	2,157	E4 3919	2NE 343 130-277	2,108
E4 14801	2TM 357 009-111	2,352	E4 2899	2XT 980 855-411	2,157	E4 396	2SK 003 567-321	2,22, 2,287
E4 14802	2PS 357 009-001	2,352	E4 2899	2XT 980 855-417	2,157	E4 396	2SK 003 567-331	2,22, 2,287
E4 14802	2PS 357 009-101	2,352	E4 2900	2VA 980 710-061	2,65, 2,303	E4 396	2SK 003 567-651	2,22, 2,287
e4 1586	2SD 959 050-401	2,64, 2,302	E4 2900	2VA 980 710-301	2,65, 2,303	E4 396	2SK 003 567-661	2,22, 2,287
E4 17063	2NR 357 029-061	2,350	E4 2901	2SD 980 602-211	2,65, 2,303	E4 396	2SL 003 567-691	2,22
E4 17063	2NR 357 029-161	2,350	E4 2901	2SD 980 613-211	2,65, 2,303	E4 396	2VD 003 567-371	2,21
E4 17064	2SD 357 029-001	2,349	E4 2906	2KA 959 640-102	2,156	E4 396	9EL 122 772-001	2,22-2,23, 2,287
E4 17064	2SD 357 029-101	2,349	E4 3	2KA 959 640-607	2,156, 2,325	E4 397	2SK 003 567-321	2,22, 2,287
E4 17064	2SW 357 029-021	2,349	E4 3	9EL 114 401-001	2,144	E4 397	2SK 003 567-331	2,22, 2,287
E4 170643	2SW 357 029-121	2,349	e4 305	9EL 135 548-001	2,18	E4 397	2SK 003 567-651	2,22, 2,287
E4 2	9EL 114 401-001	2,144	E4 3134	2SL 003 567-311	2,22, 2,287	E4 397	2SK 003 567-661	2,22, 2,287
E4 22	1AD 003 305-001	1,63	E4 3134	2VD 003 567-371	2,21	E4 397	2SL 003 567-311	2,22, 2,287
E4 23006	2ZR 996 506-501	2,197, 2,329	E4 3134	2VP 003 567-111	2,21, 2,287	E4 397	2SL 003 567-691	2,22
E4 23152	2PG 002 727-021	2,144	E4 3134	2VP 003 567-121	2,21, 2,287	E4 397	2VD 003 567-371	2,21
E4 23152	2PG 004 361-011	2,144	E4 3134	9EL 122 689-021	2,21, 2,23, 2,287	E4 397	2VP 003 567-111	2,21, 2,287
E4 23152	2PG 004 361-017	2,144	E4 3153	2PG 962 964-041	2,137	E4 397	2VP 003 567-121	2,21, 2,287
E4 23152	2PS 002 727-001	2,144	E4 3153	2PG 962 964-051	2,137	E4 397	2VP 003 567-127	2,21
E4 23152	2PS 004 361-001	2,144	E4 3153	2PG 962 964-057	2,137	E4 397	9BG 130 945-001	2,23
E4 23152	2PS 004 361-007	2,144	E4 3153	2PS 962 964-012	2,137	E4 397	9BG 130 946-001	2,23
E4 23152	2TM 004 361-021	2,144	E4 3153	2PS 962 964-018	2,137	E4 397	9EL 122 689-021	2,21, 2,23, 2,287
E4 23152	9EL 114 401-001	2,144	E4 3153	2PS 962 964-031	2,137	E4 397	9EL 122 689-051	2,23
E4 23152	9EL 114 401-031	2,144	E4 3153	2PS 962 964-037	2,137	E4 397	9EL 122 772-001	2,22-2,23, 2,287
E4 23167	2SK 005 883-011	2,18	E4 3169	2PS 008 382-001	2,164	E4 397	9EL 122 772-051	2,21-2,23, 2,36, 2,285, 2,287
E4 23167	2SK 005 883-021	2,18	E4 3169	2PS 008 382-007	2,164	E4 397	9GP 003 995-801	2,285, 2,287
E4 23167	2SL 005 883-031	2,18	E4 3169	2PS 008 382-801	2,164	E4 4026	2SK 005 883-011	2,18
E4 23167	2SL 005 883-041	2,18	E4 3169	2PS 008 382-811	2,164	E4 4026	2SK 005 883-021	2,18
e4 23167	9EL 135 548-001	2,18	E4 3169	2PS 008 382-817	2,164	E4 4026	2SL 005 883-031	2,18
E4 23215	2SK 003 567-321	2,22, 2,287	E4 3169	9EL 154 637-001	2,164	E4 4026	2SL 005 883-041	2,18
E4 23215	2SK 003 567-331	2,22, 2,287	E4 3178	2VD 008 204-051	2,10, 2,290	E4 4026	9EL 135 548-001	2,18
E4 23215	2SK 003 567-651	2,22, 2,287	E4 3178	2VD 008 204-071	2,10, 2,290	E4 4026	2SL 003 567-691	2,22
E4 23215	2SK 003 567-661	2,22, 2,287	E4 3178	2VD 008 204-131	2,10, 2,290	E4 4033	2VD 003 567-371	2,21
E4 23215	2SL 003 567-311	2,22, 2,287	E4 3178	2VD 008 204-141	2,10, 2,290	E4 4033	9EL 122 689-021	2,21, 2,23, 2,287
E4 23215	2SL 003 567-691	2,22	E4 3178	2VD 008 204-171	2,10, 2,290	E4 4033	9EL 122 689-051	2,23
E4 23215	2VD 003 567-371	2,21	E4 3178	2VD 008 204-191	2,10	E4 4033	9EL 122 772-001	2,22-2,23, 2,287
E4 23215	2VP 003 567-111	2,21, 2,287	E4 3178	2VD 008 204-211	2,09, 2,289	E4 4039	2VD 007 323-031	2,08
E4 23215	2VP 003 567-121	2,21, 2,287	E4 3178	2VD 008 204-231	2,09, 2,289	E4 4039	2VD 007 323-041	2,08
E4 23215	2VP 003 567-127	2,21	E4 3178	2VD 008 204-251	2,09, 2,289	E4 4039	2VD 007 323-131	2,08
E4 23215	9BG 130 945-001	2,23	E4 3178	2VD 008 205-011	2,12, 2,292	E4 4039	2VD 007 323-141	2,08
E4 23215	9BG 130 946-001	2,23	E4 3178	2VD 008 205-021	2,12, 2,292	E4 4039	2VP 007 323-011	2,08
E4 23215	9EL 122 689-021	2,21, 2,23, 2,287	E4 3178	2VD 008 205-041	2,12, 2,292	E4 4039	2VP 007 323-021	2,08
E4 23215	9EL 122 689-051	2,23	E4 3178	2VD 008 205-051	2,12, 2,292	E4 4039	2VP 007 323-091	2,09
E4 23215	9EL 122 772-001	2,22-2,23, 2,287	E4 3178	2VP 008 204-041	2,10, 2,290	E4 4039	2VP 007 323-101	2,09
E4 23215	9EL 122 772-051	2,23	E4 3178	2VP 008 204-061	2,10, 2,290	E4 4039	2VP 007 323-111	2,08
E4 23215	9GP 003 995-801	2,21-2,23, 2,36, 2,285, 2,287	E4 3178	2VP 008 204-161	2,10, 2,290	E4 4039	2VP 007 323-121	2,08
E4 23254	2ZR 964 169-351	2,96	E4 3178	2VP 008 204-181	2,10	E4 4039	9EL 146 887-001	2,08-2,09
E4 23254	2ZR 964 169-361	2,96	E4 3178	2VP 008 204-201	2,09, 2,289	E4 4044	2SE 998 530-061	2,56
E4 23255	2ZR 009 001-011	2,84	E4 3178	2VP 008 204-221	2,09, 2,289	E4 4044	2SE 998 530-067	2,56
E4 23255	2ZR 009 001-017	2,84	E4 3178	2VP 008 204-241	2,09, 2,289	E4 4060	2NE 357 026-031	2,354
E4 23255	2ZR 009 001-117	2,84	E4 3178	2VP 008 205-031	2,12, 2,292	E4 4060	2VD 008 204-051	2,10, 2,290
E4 23257	2ZR 343 130-041	2,112	E4 3178	9EL 152 884-001	2,12, 2,292	E4 4060	2VD 008 204-071	2,10, 2,290
E4 23257	2ZR 343 130-047	2,112	E4 3178	9EL 152 889-001	2,09-2,10, 2,289-2,290	E4 4060	2VD 008 204-091	2,11, 2,291
E4 23257	2ZR 343 130-387	2,107	E4 3179	2VD 008 204-091	2,11, 2,291	E4 4060	2VD 008 204-111	2,11, 2,291
E4 23257	2ZR 343 130-607	2,112	E4 3179	2VD 008 204-111	2,11, 2,291	E4 4060	2VD 008 204-131	2,10, 2,290
E4 23262	2ZR 996 179-701	2,200, 2,329	E4 3179	2VP 008 204-081	2,11, 2,291	E4 4060	2VD 008 204-141	2,10
E4 23271	2ZR 357 026-041	2,354	E4 3179	2VP 008 204-101	2,11, 2,291	E4 4060	2VD 008 204-171	2,10, 2,290
E4 2336	2ZR 001 240-351	2,104	E4 3179	2VP 008 204-111	2,11, 2,291	E4 4060	2VD 008 204-191	2,10
E4 2336	2ZR 001 240-377	2,104	E4 3179	9EL 152 891-001	2,11, 2,291	E4 4060	2VD 008 204-211	2,09, 2,289
E4 23474	2ZR 357 029-051	2,350	E4 3189	8RA 009 001-031	2,84	E4 4060	2VD 008 204-231	2,09, 2,289
E4 23474	2ZR 357 029-151	2,350	E4 3189	8RA 009 001-037	2,84	E4 4060	2VD 008 204-251	2,09, 2,289
E4 279	2VD 007 323-031	2,08	E4 3190	8RA 343 160-002	2,155	E4 4060	2VD 008 205-011	2,12, 2,292
E4 279	2VD 007 323-041	2,08	E4 3190	8RA 343 160-007	2,155	E4 4060	2VD 008 205-021	2,12, 2,292
E4 279	2VD 007 323-131	2,08	E4 3190	8RA 343 160-017	2,155	E4 4060	2VD 008 205-041	2,12, 2,292
E4 279	2VD 007 323-141	2,08	E4 3190	8RA 343 160-022	2,155	E4 4060	2VD 008 205-051	2,12, 2,292
E4 279	2VP 007 323-011	2,08	E4 3190	8RA 343 160-027	2,155	E4 4060	2VP 008 204-041	2,10, 2,290
E4 279	2VP 007 323-021	2,08	E4 3191	8RA 343 220-007	2,259, 2,328	E4 4060	2VP 008 204-061	2,10, 2,290
E4 279	2VP 007 323-091	2,09	E4 3191	8RA 343 220-017	2,259, 2,328	E4 4060	2VP 008 204-081	2,11, 2,291
E4 279	2VP 007 323-101	2,09	E4 3302	8RA 009 362-001	2,79-2,80	E4 4060	2VP 008 204-101	2,11, 2,291
E4 279	2VP 007 323-111	2,08	E4 3322	8RA 344 065-007	2,40	E4 4060	2VP 008 204-121	2,10, 2,290
E4 279	2VP 007 323-121	2,08	E4 377	2SK 003 567-321	2,22, 2,287	E4 4060	2VP 008 204-201	2,09, 2,289
E4 279	9EL 146 887-001	2,08-2,09	E4 377	2SK 003 567-331	2,22, 2,287	E4 4060	2VP 008 204-221	2,09, 2,289
E4 280	2VD 007 323-031	2,08	E4 377	2SK 003 567-651	2,22, 2,287	E4 4060	2VP 008 204-241	2,09, 2,289
E4 280	2VD 007 323-041	2,08	E4 377	2SK 003 567-661	2,22, 2,287	E4 4060	2VP 008 205-031	2,12, 2,292
E4 280	2VD 007 323-131	2,08	E4 377	2SL 003 567-311	2,22, 2,287	E4 4060	9EL 152 884-001	2,12, 2,292
E4 280	2VD 007 323-141	2,08	E4 377	2SL 003 567-691	2,22	E4 4060	9EL 152 889-001	2,09-2,10, 2,289-2,290
E4 280	2VP 007 323-011	2,08	E4 377	2VD 003 567-371	2,21	E4 4060	9EL 152 891-001	2,11, 2,291
E4 280	2VP 007 323-021	2,08	E4 377	2VP 0				



Type approval numbers

Type approval no.	Part no.	Page	Type approval no.	Part no.	Page	Type approval no.	Part no.	Page
E4 469	9EL 114 401-031	2.144	E4 6546	2BA 009 001-107	2.84	E4 9417	2PS 007 943-321	2.161
E4 5851	2BA 959 932-051	2.212	E4 6546	2BA 009 001-167	2.84	E4 9471	1EA 990 185-021	1.76-1.78
E4 61200	2BA 357 026-021	2.354	E4 6546	2BA 009 001-191	2.84	E4 9471	1EA 993 975-011	1.76
E4 61970	2BA 357 029-031	2.349	E4 6546	2BA 009 001-201	2.84	E4 9471	1EA 993 975-017	1.76
E4 61970	2BA 357 029-131	2.349	E4 6546	2BA 009 001-737	2.84	E4 9471	1EA 993 975-021	1.76
E4 6484	2SE 998 530-061	2.56	E4 6550	2BA 343 130-051	2.112	E4 9471	1EA 993 975-027	1.76
E4 6484	2SE 998 530-067	2.56	E4 6550	2BA 343 130-057	2.112	E4 9471	1EA 993 975-051	1.76
E4 6495	1EA 993 975-011	1.76	E4 6550	2BA 343 130-297	2.109	E4 9471	1EA 993 975-057	1.76
E4 6495	1EA 993 975-017	1.76	E4 6550	2BA 343 130-307	2.109	E4 9471	1EA 993 975-061	1.76
E4 6495	1EA 993 975-021	1.76	E4 6550	2BA 343 130-537	2.109	E4 9471	1EA 993 975-067	1.76
E4 6495	1EA 993 975-027	1.76	E4 6550	2BA 343 130-547	2.109	E4 9471	1EA 993 975-091	1.76
E4 6495	1EA 993 975-051	1.76	E4 6550	2BA 343 130-577	2.112	E4 9471	1EA 993 975-097	1.76
E4 6495	1EA 993 975-057	1.76	E4 6550	2BA 343 130-587	2.112	E4 9471	1EA 993 975-101	1.76
E4 6495	1EA 993 975-061	1.76	E4 6550	2BA 343 390-071	2.106	E4 9471	1EA 993 975-107	1.76
E4 6495	1EA 993 975-067	1.76	E4 6550	2BA 344 130-747	2.107	E4 9471	1EA 993 975-337	1.76
E4 6495	1EA 993 975-091	1.76	E4 6551	2BA 009 204-041	2.212	E4 9471	1EA 993 975-347	1.76
E4 6495	1EA 993 975-097	1.76	E4 6551	2BA 009 204-051	2.212	E4 9471	1EA 993 975-397	1.76
E4 6495	1EA 993 975-101	1.76	E4 6551	2BA 009 204-057	2.212	E4 9471	1EA 996 074-051	1.68
E4 6495	1EA 993 975-107	1.76	E4 7499	2PF 962 964-061	2.137	E4 9471	1EA 996 074-061	1.68
E4 6495	1EA 993 975-337	1.76	E4 7499	2PF 962 964-071	2.137	E4 9471	1EA 996 074-177	1.68
E4 6495	1EA 993 975-347	1.76	E4 7499	2PG 962 964-041	2.137	E4 9471	1EA 996 074-187	1.68
E4 6495	1EA 993 975-397	1.76	E4 7499	2PG 962 964-051	2.137	E4 9471	1EA 996 081-171	1.77
E4 6495	1EA 996 074-051	1.68	E4 7499	2PG 962 964-057	2.137	E4 9471	1EA 996 081-177	1.77
E4 6495	1EA 996 074-061	1.68	E4 7504	2SE 998 530-067	2.56	E4 9471	1EA 996 127-001	1.78
E4 6495	1EA 996 074-177	1.68	E4 7504	2SE 998 530-067	2.56	E4 9471	1EA 996 127-007	1.78
E4 6495	1EA 996 074-187	1.68	E4 7507	2SA 962 964-091	2.137	E4 9471	1EA 996 127-051	1.78
E4 6495	1EA 996 081-171	1.77	E4 7547	2DA 959 071-037	2.203	E4 9471	1EA 996 127-077	1.78
E4 6495	1EA 996 081-177	1.77	E4 7547	2DA 959 071-237	2.203	E4 9808	2VD 008 204-051	2.10, 2.290
E4 6495	9EL 990 186-001	1.68, 1.76-1.77	E4 7547	2DA 959 071-537	2.203	E4 9808	2VD 008 204-071	2.10, 2.290
E4 6504	9EL 857 801-001	3.26	E4 7547	2DA 959 071-737	2.203	E4 9808	2VD 008 204-131	2.10, 2.290
E4 6504	9EL 857 803-001	3.26	E4 7547	2DA 959 071-757	2.203	E4 9808	2VD 008 204-141	2.10
E4 6505	1EA 993 975-011	1.76	E4 7547	2DA 959 071-787	2.203	E4 9808	2VD 008 204-171	2.10, 2.290
E4 6505	1EA 993 975-017	1.76	E4 7574	2XA 959 560-401	2.167	E4 9808	2VD 008 204-191	2.10
E4 6505	1EA 993 975-021	1.76	E4 7574	2XA 959 560-407	2.167	E4 9808	2VD 008 204-211	2.09, 2.289
E4 6505	1EA 993 975-027	1.76	E4 7574	2XA 959 560-411	2.167	E4 9808	2VD 008 204-231	2.09, 2.289
E4 6505	1EA 993 975-051	1.76	E4 7574	2XA 959 560-417	2.167	E4 9808	2VD 008 204-251	2.09, 2.289
E4 6505	1EA 993 975-057	1.76	E4 7597	2XA 959 790-401	2.155	E4 9808	2VD 008 205-011	2.12, 2.292
E4 6505	1EA 993 975-061	1.76	E4 7597	2XA 959 790-407	2.155	E4 9808	2VD 008 205-021	2.12, 2.292
E4 6505	1EA 993 975-067	1.76	E4 7597	2XA 959 790-411	2.155	E4 9808	2VD 008 205-041	2.12, 2.292
E4 6505	1EA 993 975-091	1.76	E4 7613	2DA 009 001-051	2.83	E4 9808	2VD 008 205-051	2.12, 2.292
E4 6505	1EA 993 975-097	1.76	E4 7613	2DA 009 001-057	2.83	E4 9808	2VP 008 204-041	2.10, 2.290
E4 6505	1EA 993 975-101	1.76	E4 7613	2DA 009 001-147	2.83	E4 9808	2VP 008 204-061	2.10, 2.290
E4 6505	1EA 993 975-107	1.76	E4 7613	2PF 009 001-081	2.83	E4 9808	2VP 008 204-121	2.10, 2.290
E4 6505	1EA 993 975-337	1.76	E4 7613	2PF 009 001-177	2.83	E4 9808	2VP 008 204-161	2.10, 2.290
E4 6505	1EA 993 975-347	1.76	E4 7613	2SA 009 001-137	2.83	E4 9808	2VP 008 204-181	2.10
E4 6505	1EA 993 975-397	1.76	E4 7613	2SB 009 001-061	2.83	E4 9808	2VP 008 204-201	2.09, 2.289
E4 6505	1EA 996 081-171	1.77	E4 7613	2SB 009 001-067	2.83	E4 9808	2VP 008 204-221	2.09, 2.289
E4 6505	1EA 996 081-177	1.77	E4 7613	2SB 009 001-157	2.83	E4 9808	2VP 008 204-241	2.09, 2.289
E4 6506	9EL 856 415-001	3.26	E4 7696	2DA 343 106-001	2.205	E4 9808	2VP 008 205-031	2.12, 2.292
E4 6506	9EL 856 416-001	3.26, 3.27	E4 7696	2DA 343 106-007	2.205	E4 9808	9EL 152 884-001	2.12, 2.292
E4 6506	9EL 856 416-011	3.27	E4 7696	2DA 343 106-011	2.205	E4 9808	9EL 152 889-001	2.09-2.10, 2.289-2.290
E4 6509	2RL 006 846-001	3.04	E4 7696	2DA 343 106-017	2.205	E4 9809	2VD 008 204-091	2.11, 2.291
E4 6509	2RL 006 846-011	3.04	E4 7696	2DA 343 106-021	2.205	E4 9809	2VD 008 204-111	2.11, 2.291
E4 6509	2RL 007 337-001	3.04	E4 7696	2DA 343 106-027	2.205	E4 9809	2VP 008 204-081	2.11, 2.291
E4 6509	2RL 007 337-011	3.04	E4 7696	2DA 343 106-031	2.205	E4 9809	2VP 008 204-101	2.11, 2.291
E4 6509	2RL 007 337-021	3.05	E4 7696	2DA 343 106-037	2.205	E4 9809	9EL 152 891-001	2.11, 2.291
E4 6509	2RL 007 337-031	3.05	E4 7696	2DA 343 106-201	2.205	E4 9810	2VD 008 204-051	2.10, 2.290
E4 6509	2RL 007 337-041	3.04	E4 7696	2DA 343 106-207	2.205	E4 9810	2VD 008 204-071	2.10, 2.290
E4 6509	2RL 007 337-057	3.05	E4 7696	2DA 343 106-211	2.205	E4 9810	2VD 008 204-091	2.11, 2.291
E4 6509	9EL 859 020-001	3.04-3.05	E4 7696	2DA 343 106-217	2.205	E4 9810	2VD 008 204-111	2.11, 2.291
E4 6510	2RL 007 017-041	3.18	E4 7696	2DA 343 106-221	2.205	E4 9810	2VD 008 204-131	2.10, 2.290
E4 6510	2RL 007 017-051	3.18	E4 7696	2DA 343 106-227	2.205	E4 9810	2VD 008 204-141	2.10
E4 6510	9EL 859 658-001	3.18, 3.28	E4 7696	2DA 343 106-231	2.205	E4 9810	2VD 008 204-171	2.10, 2.290
E4 6511	2RL 007 017-061	3.18	E4 7698	2SB 343 130-027	2.111	E4 9810	2VD 008 204-191	2.10
E4 6511	2RL 007 017-071	3.18	E4 7698	2SB 343 130-757	2.111	E4 9810	2VD 008 204-211	2.09, 2.289
E4 6511	9EL 859 658-011	3.18, 3.28	E4 7698	2SB 343 130-767	2.111	E4 9810	2VD 008 204-231	2.09, 2.289
E4 6513	2RL 006 846-101	3.04	E4 7698	2SB 343 390-091	2.106	E4 9810	2VD 008 204-251	2.09, 2.289
E4 6513	2RL 006 846-111	3.04	E4 7715	2DA 343 800-001	2.204	E4 9810	2VP 008 204-041	2.10, 2.290
E4 6513	2RL 007 337-101	3.04	E4 7715	2DA 343 800-007	2.204	E4 9810	2VP 008 204-061	2.10, 2.290
E4 6513	2RL 007 337-111	3.04	E4 7715	2DA 343 800-027	2.204	E4 9810	2VP 008 204-081	2.11, 2.291
E4 6513	2RL 007 337-121	3.05	E4 7715	2DA 343 800-047	2.204	E4 9810	2VP 008 204-101	2.11, 2.291
E4 6513	9EL 859 020-101	3.04-3.05	E4 7715	2DA 343 800-057	2.204	E4 9810	2VP 008 204-121	2.11, 2.291
E4 6514	2RL 007 550-001	3.07	E4 7747	2SB 009 362-011	2.79	E4 9810	2VP 008 204-141	2.10, 2.290
E4 6514	2RL 007 550-011	3.07	E4 7747	2SB 009 362-021	2.79	E4 9810	2VP 008 204-161	2.10, 2.290
E4 6514	2RL 007 550-021	3.07	E4 7747	2SB 009 362-041	2.79	E4 9810	2VP 008 204-181	2.10
E4 6514	2RL 007 551-001	3.08	E4 7747	2SB 009 362-067	2.79	E4 9810	2VP 008 204-201	2.09, 2.289
E4 6514	2RL 007 551-011	3.08	E4 7747	2SD 010 546-127	2.82	E4 9810	2VP 008 204-221	2.09, 2.289
E4 6514	2RL 007 551-021	3.08	E4 7747	2SD 010 546-137	2.82	E4 9810	2VP 008 204-241	2.09, 2.289
E4 6514	2RL 007 552-001	3.08	E4 7748	2SB 009 362-011	2.79	E4 9810	9EL 152 889-001	2.09-2.10, 2.289-2.290
E4 6514	2RL 007 552-011	3.08	E4 7748	2SB 009 362-021	2.79	E4 9810	9EL 152 891-001	2.11, 2.291
E4 6514	2RL 007 552-021	3.08	E4 7748	2SB 009 362-041	2.79	E4 9811	2VD 008 205-011	2.12, 2.292
E4 6514	2RL 007 553-001	3.09	E4 7748	2SD 010 546-127	2.82	E4 9811	2VD 008 205-021	2.12, 2.292
E4 6514	2RL 007 553-011	3.09	E4 7748	2SD 010 546-137	2.82	E4 9811	2VD 008 205-041	2.12, 2.292
E4 6514	2RL 007 553-021	3.09	E4 7748	2SD 010 546-101	2.79	E4 9811	2VD 008 205-051	2.12, 2.292
E4 6514	9EL 860 627-001	3.07-3.08	E4 7981	2DA 357 015-101	2.362	E4 9811	2VP 008 205-031	2.12, 2.292
E4 6514	9EL 860 627-011	3.09	E4 7981	2DA 357 015-107	2.362	E4 9811	9EL 152 884-001	2.12, 2.292
E4 6516	2RL 007 900-701	3.58	E4 8018	2SB 357 026-011	2.354	E4 9823	2SD 964 169-331	2.95
E4 6542	1E3 996 160-637	1.71	E4 8114	2PG 357 010-021	2.352	E4 9836	2VA 341 419-011	2.43
E4 6542	1E3 996 160-647	1.71	E4 8114	2PG 357 010-121	2.352	E4 9836	2VA 341 419-021	2.43
E4 6542	1E3 996 160-671	1.71	E4 8115	2TM 357 010-111	2.352	E4 9836	2VA 341 419-061	2.43
E4 6542	1E3 996 160-681	1.71	E4 8115	2TM 357 010-111	2.352	E4 9836	2VA 341 419-111	2.43
E4 6542	1EB 996 167-031	1.70	E4 8595	2SB 357 029-011	2.349	E4 9836	2VA 341 419-117	2.43
E4 6542	1EB 996 167-038	1.70	E4 8595	2SB 357 029-111	2.349	E4 9836	2VA 341 419-147	2.43
E4 6542	1EB 996 167-041	1.70	E4 8638	2PG 357 011-021	2.357	E4 9836	2VP 341 419-047	2.43
E4 6542	1EB 996 167-048	1.70	E4 8639	2TM 357 011-011	2.357	E4 9836	2VP 341 419-121	2.43
E4 6542	1EB 996 167-177	1.70	E4 9110	2PS 008 138-001	2.			

Type approval numbers



Type approval no.	Part no.	Page	Type approval no.	Part no.	Page	Type approval no.	Part no.	Page
E6 0471	2XD 012 160-971	3.32	E9 6110	2VA 357 023-021	2.346	K 8652	9EL 856 418-011	3.27
E6 0471	2XD 012 160-981	3.32	E9 6110	2VB 357 023-011	2.346	K 8687	9EL 857 801-001	3.26
E6 0527	1GO 357 002-001	1.194	E9 6134	2VA 357 020-011	2.343	K 8694	9EL 857 803-001	3.26
E6 1375	2SL 007 547-061	2.35	E9 6134	2VB 357 020-001	2.343			
E6 1375	2SL 007 547-067	2.35	E9 6134	2VB 357 023-011	2.346			
E6 1375	2VD 007 547-181	2.35	E9 6135	2SD 357 024-001	2.340			
E6 1375	9EL 147 097-001	2.35	E9 6337	2BE 357 023-001	2.346			
E6 3018	2VB 007 547-171	2.35	E9 6400	1GO 357 000-001	1.194			
E6 3018	2VD 007 547-181	2.35	E9 6402	1GA 357 001-001	1.194			
E6 450	2SE 007 547-011	2.35	E9 6512	2SD 357 031-001	2.340			
E6 450	2SE 007 547-017	2.35	E9 6512	9EL 357 031-101	2.340			
E6 450	2SE 007 547-021	2.35	E9 6571	2BA 357 028-021	2.356			
E6 450	2SE 007 547-027	2.35	E9 6636	2SB 357 028-011	2.356			
E6 450	2SE 007 547-041	2.35	E9 6650	2SD 357 028-001	2.356			
E6 450	2SL 007 547-061	2.35	E9 6651	2SB 357 027-011	2.355			
E6 450	2SL 007 547-067	2.35	E9 6652	2BA 357 027-021	2.355			
E6 450	2VB 007 547-171	2.35	E9 6653	2SD 357 027-001	2.355			
E6 450	2VD 007 547-181	2.35	E9 6654	2BE 357 028-051	2.356			
E6 450	9EL 147 096-001	2.35	E9 6655	2BE 357 027-061	2.355			
E6 450	9EL 147 097-001	2.35	E9 6719	2VP 357 017-011	2.341			
E6 451	2SE 007 547-011	2.35	E9 6719	2VP 357 017-021	2.341			
E6 451	2SE 007 547-017	2.35	E9 6753	2XS 357 006-011	2.359			
E6 451	2SE 007 547-021	2.35	E9 6753	2XS 357 006-021	2.359			
E6 451	2SE 007 547-027	2.35	E9 6753	2XS 357 007-011	2.359			
E6 451	2SE 007 547-041	2.35	E9 6753	2XS 357 007-021	2.359			
E6 451	2SL 007 547-061	2.35	E9 6754	2XS 357 003-001	2.362			
E6 451	2SL 007 547-067	2.35	E9 6754	2XS 357 004-011	2.361			
E6 451	2VB 007 547-171	2.35	E9 6754	2XS 357 004-021	2.361			
E6 451	2VD 007 547-181	2.35	E9 6754	2XS 357 004-031	2.361			
E6 451	9EL 147 096-001	2.35	E9 6754	2XS 357 005-011	2.360			
E6 451	9EL 147 097-001	2.35	E9 6754	2XS 357 005-021	2.360			
E6 452	2SE 007 547-011	2.35	E9 6754	2XS 357 005-031	2.360			
E6 452	2SE 007 547-017	2.35	E9 6754	2XS 357 005-041	2.360			
E6 452	2SE 007 547-021	2.35	E9 6823	2VP 357 016-011	2.341			
E6 452	2SE 007 547-027	2.35	E9 6823	2VP 357 016-021	2.341			
E6 452	2SE 007 547-041	2.35	E9 6823	2VP 357 016-111	2.341			
E6 452	2SL 007 547-061	2.35	E9 6823	2VP 357 016-121	2.341			
E6 452	2SL 007 547-067	2.35	E9 6847	2VA 357 021-001	2.344			
E6 452	2VD 007 547-171	2.35	E9 6881	2VP 357 021-031	2.344			
E6 452	2VD 007 547-181	2.35	E9 6881	2VP 357 021-041	2.344			
E6 452	9EL 147 096-001	2.35	E9 6891	2VP 357 016-011	2.341			
E6 452	9EL 147 097-001	2.35	E9 6891	2VP 357 016-021	2.341			
E6 453	2SE 007 547-011	2.35	E9 6891	2VP 357 016-111	2.341			
E6 453	2SE 007 547-017	2.35	E9 6891	2VP 357 016-121	2.341			
E6 453	2SE 007 547-021	2.35	E9 6958	2VP 357 021-011	2.344			
E6 453	2SE 007 547-027	2.35	K 11103/1	1SO 001 430-011	1.69			
E6 453	2VB 007 547-171	2.35	K 11103/1	9ES 012 060-011	1.69			
E6 453	9EL 147 096-001	2.35	K 11580	2SA 001 647-041	2.165			
E8 71-26	2SE 997 008-001	2.55	K 12642	2BA 001 227-201	2.208			
E8 71-26	9EL 997 332-001	2.55	K 12642	2BA 001 227-211	2.208			
E8 71-27	2SE 997 008-001	2.55	K 12642	9EL 074 484-011	2.208			
E8 71-27	9EL 997 332-001	2.55	K 12642	9EL 074 484-031	2.208			
E8 71-28	2SE 997 008-001	2.55	K 12749	2BA 001 236-001	2.213			
E8 71-28	9EL 997 332-001	2.55	K 12749	9EL 085 408-001	2.213			
E8 7305	2BE 997 006-101	2.70	K 12753	2BA 001 244-001	2.210			
E8 7306	2BE 997 006-101	2.70	K 12753	9EL 085 478-001	2.210			
E9 11422	2VP 357 018-001	2.342	K 12793	2BA 001 248-001	2.208			
E9 11490	2BE 357 022-001	2.345	K 13487	8RA 003 503-001	2.259			
E9 11491	2SD 357 022-011	2.345	K 13931	2XW 002 897-041	2.252			
E9 1151	2ZR 357 028-041	2.356	K 13931	2XW 002 897-051	2.252			
E9 11523	2BA 357 025-011	2.348	K 13932	2XW 003 146-001	2.253			
E9 11523	2SB 357 025-001	2.348	K 13949	2XW 007 146-001	2.252, 2.329			
E9 11523	2ZR 357 025-021	2.348	K 13950	2XW 007 146-011	2.253, 2.330			
E9 1158	2NE 357 028-031	2.356	K 18614	2RL 007 337-057	3.05			
E9 1184	2NE 357 027-031	2.355	K 18614	9EL 859 020-001	3.04-3.05			
E9 1192	2ZR 357 027-041	2.355	K 18614	9EL 859 020-011	3.04-3.05			
E9 1248	2KA 357 013-001	2.358	K 18651	9EL 859 658-011	3.18, 3.28			
E9 1280	2PG 357 012-021	2.353	K 18652	9EL 859 658-001	3.18, 3.28			
E9 1280	2PS 357 012-001	2.353	K 18659	9EL 859 020-101	3.04-3.05			
E9 1280	2TM 357 012-011	2.353	K 21032	1S3 001 117-041	1.69			
E9 1280	9EL 357 012-101	2.353	K 21032	9ES 015 675-001	1.69			
E9 1280	9EL 357 012-111	2.353	K 21037	1S3 001 117-041	1.69			
E9 1280	9EL 357 012-121	2.353	K 21037	9ES 015 675-001	1.69			
E9 1288	2NR 357 027-051	2.355	K 21047	1S3 001 442-001	1.68			
E9 1529	5DS 357 030-001	2.340, 2.342-2.346, 2.348-2.349, 2.354-2.356	K 21090	1TA 003 570-001	1.67			
E9 1538	2SD 959 010-401	2.90, 2.309	K 21090	1TA 003 570-101	1.75			
E9 1538	2SD 959 010-407	2.90, 2.309	K 21090	1TA 122 718-001	1.67			
E9 1553	2PG 357 008-031	2.351	K 22609	2BA 001 263-001	2.213			
E9 1553	2PS 357 008-001	2.351	K 23237	2BE 003 018-011	2.73			
E9 1553	2PS 357 008-011	2.351	K 23246	2BE 001 278-011	2.219			
E9 1553	2TM 357 008-021	2.351	K 23246	2BE 001 278-021	2.219			
E9 1761	2BE 357 032-001	2.347	K 23246	9EL 087 769-001	2.219			
E9 1761	2SE 357 032-011	2.347	K 23256/1	2SB 001 673-002	2.63			
E9 1761	2SE 357 032-021	2.347	K 23256/1	2ST 001 673-011	2.63			
E9 1761	2VB 357 032-031	2.347	K 23260/1	2SB 003 018-031	2.73			
E9 1761	9EL 357 032-101	2.347	K 23260/1	2ST 003 018-061	2.73			
E9 1761	9EL 357 032-111	2.347	K 23260/1	9EL 089 114-001	2.73			
E9 1789	2KA 357 014-001	2.358	K 23267	2BA 001 259-611	2.115			
E9 1948	2VP 357 019-001	2.342	K 23267	2BA 001 259-618	2.115			
E9 1948	2VP 357 019-011	2.342	K 23267	9EL 088 150-001	2.115			
E9 1966	2SD 357 033-001	2.345	K 23269	2BE 001 259-061	2.114			
E9 1966	9EL 357 033-111	2.345	K 23269	9EL 088 538-001	2.114			
E9 5167	2VD 008 789-011	2.20	K 23270	2SB 001 259-261	2.113			
E9 5167	2VP 008 789-021	2.20	K 23270	2ST 001 259-321	2.113			
E9 5167	2VP 008 789-041	2.20	K 23318	9EL 088 525-001	2.113			
E9 5167	2VP 008 789-051	2.20	K 31420	2SB 001 301-021	2.63			
E9 5167	2VP 008 789-071	2.20	K 33256	2TF 001 259-761	2.113			
E9 5447	2VA 998 232-251	2.50	K 33265	9EL 092 435-011	2.24			
E9 5447	2VA 998 232-291	2.50	K 33265	2SD 001 305-021	2.54			
E9 5447	2VB 998 232-011	2.47	K 33375	9EL 052 476-001	2.54			
E9 5447	2VB 998 232-021	2.47	K 33375	2SD 001 306-061	2.53			
E9 5447	2VB 998 232-101	2.49	K 33375	2SE 001 306-051	2.53			
E9 5447	2VB 998 232-131	2.49	K 33375	9EL 104 571-031	2.53			
E9 5447	2VB 998 232-171	2.49	K 33375	9EL 104 571-041	2.53			
E9 5447	2VB 998 232-201	2.49	K 4106	2XS 003 168-071	2.192			
E9 5447	2VB 998 232-211	2.48	K 4106	2XS 003 168-081	2.192			
E9 5447	2VB 998 232-221	2.48	K 43322	2SE 001 679-051	2.63			
E9 5447	2VB 998 232-231	2.50	K 43322	9EL 126 294-001	2.63			
E9 5447	2VB 998 232-241	2.50	K 53397	2SD 001 679-001	2.63			
E9 5447	2VP 998 232-261	2.50	K 53397	2SE 001 679-051	2.63			
E9 5447	2VP 998 232-301	2.50	K 8649	9EL 126 294-001	2.63			
E9 5447	9EL 990 632-001	2.47-2.48	K 8650	9EL 856 415-001	3.26			
E9 5447	9EL 990 632-011							

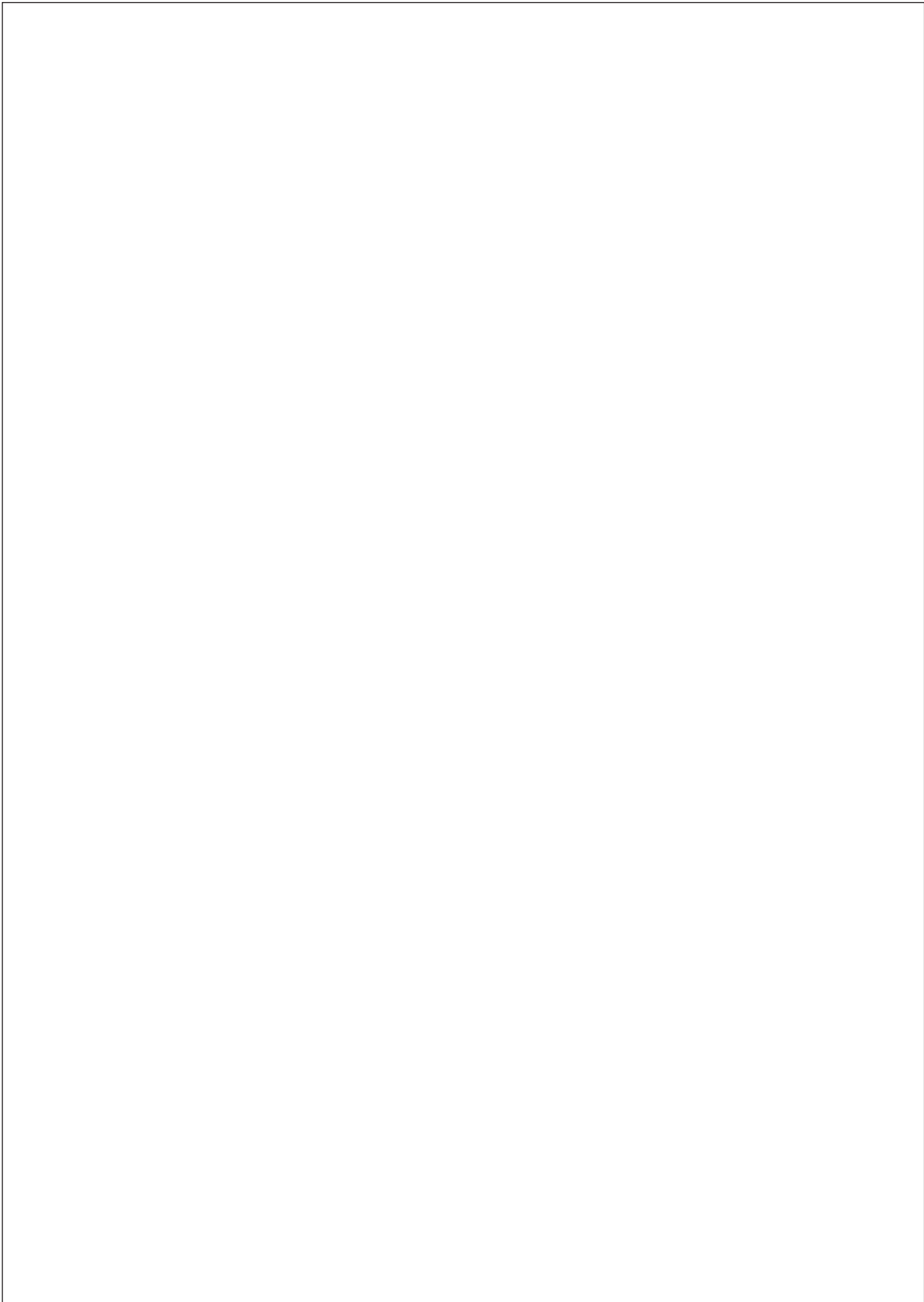

Type approval numbers



Part no.	Type approval no.	Page	Part no.	Type approval no.	Page	Part no.	Type approval no.	Page
1A3 001 120-001	E1 4414	1.59	1B3 114 179-001	E1 14470	1.59	1EA 993 975-107	E4 6495	1.76
1A3 002 850-001	E1 14578	1.58, 1.72	1B3 128 267-001	E1 34419	1.59	1EA 993 975-107	E4 6505	1.76
1A3 002 850-001	E1 24542	1.58, 1.72	1BA 996 261-021	E4 0004	1.85	1EA 993 975-107	E4 9471	1.76
1A3 002 850-031	E1 14578	1.58, 1.72-1.73	1BA 996 261-197	E4 0004	1.85	1EA 993 975-337	E4 6495	1.76
1A3 002 850-031	E1 24526	1.58, 1.72-1.73	1BL 005 380-011	E1 21690	1.62	1EA 993 975-337	E4 6505	1.76
1A3 002 850-031	E1 24542	1.58, 1.72-1.73	1BL 005 380-011	E1 7402	1.62	1EA 993 975-337	E4 9471	1.76
1A3 003 370-041	E1 14468	1.58	1BL 005 380-021	E1 21690	1.62	1EA 993 975-347	E4 6495	1.76
1A3 005 649-007	E1 14578	1.58	1BL 005 380-021	E1 7402	1.62	1EA 993 975-347	E4 6505	1.76
1A3 005 649-007	E1 24542	1.58	1BL 005 380-031	E1 21690	1.62	1EA 993 975-347	E4 9471	1.76
1A3 005 760-501	E1 44413	1.83	1BL 005 380-031	E1 7402	1.62	1EA 993 975-397	E4 6495	1.76
1A3 005 760-507	E1 44413	1.83	1BL 005 380-041	E1 21690	1.62	1EA 993 975-397	E4 6505	1.76
1A3 005 760-518	E1 44413	1.83	1BL 005 380-041	E1 7402	1.62	1EA 993 975-397	E4 9471	1.76
1A3 125 195-015	E1 14468	1.58	1BL 005 740-091	E1 7414	1.63	1EA 996 074-051	E4 6495	1.68
1A3 990 016-011	E12 20001	1.72	1BL 005 740-101	E1 7414	1.63	1EA 996 074-051	E4 9471	1.68
1A3 990 016-011	E12 2002	1.72	1BL 006 349-007	E1 7415	1.56	1EA 996 074-061	E4 6495	1.68
1A3 996 002-051	E12 1001	1.57	1BL 006 349-011	E1 7415	1.56	1EA 996 074-061	E4 9471	1.68
1A3 996 002-051	E12 1002	1.57	1BL 007 834-007	E1 550	1.54	1EA 996 074-177	E4 6495	1.68
1A3 996 002-161	E12 20001	1.72	1BL 007 834-037	E1 550	1.54	1EA 996 074-177	E4 9471	1.68
1A3 996 002-161	E12 20002	1.72	1BL 007 834-047	E1 550	1.54	1EA 996 074-187	E4 6495	1.68
1A3 996 002-181	E12 20001	1.58	1BL 007 834-132	E1 550	1.54	1EA 996 074-187	E4 9471	1.68
1A3 996 002-181	E12 20002	1.58	1BL 008 193-001	E1 917	1.41	1EA 996 081-171	E4 6495	1.77
1A3 996 002-191	E12 20001	1.72	1BL 008 193-007	E1 917	1.41	1EA 996 081-171	E4 6505	1.77
1A3 996 002-191	E12 20002	1.72	1BL 008 193-011	E1 917	1.41	1EA 996 081-171	E4 9471	1.77
1A3 996 002-211	E12 20001	1.58	1BL 008 193-017	E1 917	1.41	1EA 996 081-177	E4 6495	1.77
1A3 996 002-211	E12 20002	1.58	1BL 008 194-001	E1 917	1.42	1EA 996 081-177	E4 6505	1.77
1A3 996 002-261	E12 20001	1.57	1BL 008 194-007	E1 917	1.42	1EA 996 081-177	E4 9471	1.77
1A3 996 002-261	E12 20002	1.57	1BL 008 194-027	E1 917	1.42	1EA 996 127-001	E4 9471	1.78
1A3 996 002-531	E12 20001	1.58	1BL 009 071-001	E1 1903	1.39	1EA 996 127-007	E4 9471	1.78
1A3 996 002-531	E12 20002	1.58	1BL 009 071-007	E1 1903	1.39	1EA 996 127-051	E4 9471	1.78
1A3 996 026-011	E12 1001	1.73	1BL 009 071-047	E1 1903	1.39	1EA 996 127-077	E4 9471	1.78
1A3 996 026-011	E12 1002	1.73	1BL 009 071-067	E1 1903	1.39	1EB 996 167-031	E1 1502	1.70
1A3 996 026-021	E12 1001	1.73	1BL 009 999-001	E1 2486	1.49	1EB 996 167-031	E4 6542	1.70
1A3 996 026-021	E12 1002	1.73	1BL 009 999-041	E1 2486	1.49	1EB 996 167-031	E4 6543	1.70
1A3 996 026-121	E12 1001	1.73	1BL 010 820-001	E1 3159	1.50	1EB 996 167-038	E1 1502	1.70
1A3 996 026-121	E12 1002	1.73	1BL 010 820-001	E1 6189	1.50	1EB 996 167-038	E4 6542	1.70
1A3 996 162-071	E4 10198	1.57	1BL 010 820-801	E1 3159	1.50	1EB 996 167-038	E4 6543	1.70
1A3 996 162-321	E4 10198	1.57	1BL 010 820-801	E1 6189	1.50	1EB 996 167-041	E1 1502	1.70
1A3 996 162-381	E4 10198	1.57	1BL 010 820-811	E1 3159	1.50	1EB 996 167-041	E4 6542	1.70
1A3 996 162-607	E4 1098	1.72	1BL 010 820-811	E1 6189	1.50	1EB 996 167-041	E4 6543	1.70
1A5 003 178-231	E1 24423	1.74	1BL 012 488-001	E1 3831	1.46	1EB 996 167-048	E1 1502	1.70
1A5 003 178-401	E1 24450	1.74	1BL 012 488-021	E1 3831	1.46	1EB 996 167-048	E4 6542	1.70
1A5 003 178-411	E1 24450	1.74	1BL 139 277-031	E1 7407	1.56	1EB 996 167-048	E4 6543	1.70
1A5 003 190-001	E1 24423	1.74	1BL 139 278-031	E1 7407	1.56	1EB 996 167-177	E1 1502	1.70
1A5 118 740-001	E1 24423	1.74	1BL 158 060-021	E1 917	1.42	1EB 996 167-177	E4 6542	1.70
1A6 001 128-061	E1 14525	1.60	1BL 247 042-001	E1 2397	1.44	1EB 996 167-177	E4 6543	1.70
1A6 002 395-031	E4 1	1.60	1BL 247 042-007	E1 2397	1.44	1EB 996 167-187	E1 1502	1.70
1A6 002 395-071	E4 1	1.60	1BL 247 042-011	E1 2397	1.44	1EB 996 167-187	E4 6542	1.70
1A6 002 395-077	E4 1	1.60	1BL 247 042-017	E1 2397	1.44	1EB 996 167-187	E4 6543	1.70
1A6 002 395-387	E4 1	1.60	1BL 247 042-177	E1 2397	1.46	1EB 996 167-211	E4 11372	1.80
1A6 002 395-821	E4 1	1.60	1BL 247 042-177	E1 2398	1.46	1EE 996 174-331	E4 11372	1.81
1A7 003 099-001	E1 24417	1.75	1BL 247 042-197	E1 2397	1.46	1EE 996 174-441	E4 11372	1.81
1A7 003 099-011	E1 24417	1.75	1BL 247 042-197	E1 2398	1.46	1EE 996 374-001	E1 4079	1.82
1A7 117 596-001	E1 24417	1.75	1BL 998 570-001	E4 10894	1.40	1EE 996 374-011	E1 4079	1.82
1A7 118 750-001	E1 24417	1.75	1DL 005 600-097	E1 492	1.65	1EE 996 374-021	E1 4079	1.82
1AA 004 109-001	E1 34446	1.66	1DL 005 600-097	E1 7411	1.65	1F0 008 390-001	E1 1120	1.36
1AA 004 109-021	E1 34463	1.66	1DL 005 600-107	E1 492	1.65	1F0 008 390-301	E1 1120	1.38
1AA 004 109-031	E1 34446	1.66	1DL 005 600-107	E1 7411	1.65	1F0 008 390-317	E1 1120	1.38
1AA 004 109-041	E1 34463	1.66	1DL 007 872-017	E1 7411	1.65	1F0 008 390-801	E1 1120	1.36
1AA 004 109-201	E1 34463	1.66	1DL 007 872-027	E1 7411	1.65	1F0 008 390-821	E1 1120	1.38
1AA 126 924-035	E1 34446	1.66	1DL 007 872-037	E1 7411	1.65	1F0 010 293-001	E1 2680	1.41
1AA 127 473-015	E1 34463	1.66	1DL 007 872-047	E1 7411	1.65	1F0 011 988-021	E1 3831	1.52
1AA 143 897-011	E1 34463	1.79	1DL 007 872-077	E1 7411	1.65	1F0 011 988-031	E1 3831	1.52
1AB 001 100-001	E1 4578	1.66	1DL 007 872-087	E1 7411	1.65	1F0 011 988-121	E1 3831	1.52
1AB 003 177-001	E1 24460	1.60	1E3 996 160-637	E4 10198	1.71	1F0 011 988-131	E1 3831	1.52
1AB 003 177-001	E1 24461	1.60	1E3 996 160-637	E4 6542	1.71	1F0 012 206-001	E4 2827	1.17
1AB 003 177-071	E1 24460	1.60, 1.79	1E3 996 160-637	E4 6543	1.71	1F0 012 206-011	E4 2827	1.17
1AB 003 177-071	E1 24461	1.60, 1.79	1E3 996 160-647	E4 10198	1.71	1F0 012 206-112	E4 2827	1.17
1AB 003 177-611	E1 34450	1.61	1E3 996 160-647	E4 6542	1.71	1F0 996 376-181	E3 3968	1.10
1AB 003 177-791	E1 24460	1.60	1E3 996 160-647	E4 6543	1.71	1F0 996 376-181	E3 6917	1.10
1AB 003 177-791	E1 24461	1.60	1E3 996 160-671	E4 10198	1.71	1F1 009 094-041	E1 1901	1.14
1AB 004 231-001	E1 24460	1.79	1E3 996 160-671	E4 6542	1.71	1F1 009 094-051	E1 1901	1.14
1AB 004 231-001	E1 24461	1.79	1E3 996 160-671	E4 6543	1.71	1F1 009 094-091	E1 1902	1.14
1AB 006 213-001	E1 44439	1.102	1E3 996 160-681	E4 10198	1.71	1F1 161 825-021	E1 1901	1.14
1AB 006 213-011	E1 44439	1.102, 1.106	1E3 996 160-681	E4 6542	1.71	1F1 161 825-041	E1 1902	1.14
1AB 006 213-027	E1 44439	1.102	1E3 996 160-681	E4 6543	1.71	1F3 009 094-021	E1 1901	1.15
1AB 006 277-127	E1 24460	1.62	1E5 996 124-001	E1 14578	1.73	1F3 009 094-031	E1 1901	1.15
1AB 006 277-127	E1 24461	1.62	1E5 996 124-001	E1 32670	1.73	1F3 009 094-061	E1 1902	1.15
1AB 006 977-021	E1 44504	1.61	1EA 007 108-011	E1 34463	1.79	1F3 009 094-071	E1 1902	1.15
1AB 007 145-001	E1 44439	1.107	1EA 007 108-017	E1 34463	1.79	1F3 009 094-142	E1 2087	1.16
1AB 007 145-007	E1 44439	1.107	1EA 007 108-021	E1 34463	1.79	1F3 009 094-171	E1 1901	1.15
1AB 008 888-041	E1 1433	1.62	1EA 007 108-027	E1 34463	1.79	1F3 009 094-311	E1 2087	1.16
1AB 008 888-051	E1 1433	1.62	1EA 990 185-021	E4 9471	1.76-1.78	1F3 010 119-001	E1 1902	1.21
1AB 990 335-111	E1 1502	1.70	1EA 993 975-011	E4 6495	1.76	1F3 010 119-011	E1 1901	1.21
1AB 996 157-081	E1 1502	1.100	1EA 993 975-011	E4 6505	1.76	1F3 010 119-021	E1 1901	1.21
1AB 996 157-091	E1 1502	1.100	1EA 993 975-011	E4 9471	1.76	1F3 010 119-011	E1 1902	1.21
1AB 996 157-131	E1 1502	1.101	1EA 993 975-017	E4 6495	1.76	1F3 010 119-111	E1 1901	1.21
1AB 996 157-151	E1 1502	1.101	1EA 993 975-017	E4 6505	1.76	1F3 010 119-121	E1 1901	1.21
1AB 996 213-001	E1 44439	1.106	1EA 993 975-017	E4 9471	1.76	1F3 011 815-001	E1 3738	1.16
1AD 003 305-001	E4 22	1.63	1EA 993 975-021	E4 6495	1.76	1F3 011 815-031	E1 013738	1.16
1AD 996 018-001	E12 1009	1.102	1EA 993 975-021	E4 6505	1.76	1F3 161 825-011	E1 1901	1.15, 1.21
1AD 996 018-641	E12 20004	1.102	1EA 993 975-021	E4 9471	1.76	1F3 161 825-031	E1 1902	1.15, 1.21
1AD 996 018-651	E12 20004	1.102	1EA 993 975-027	E4 6495	1.76	1F3 161 825-071	E1 2087	1.16
1AE 003 427-011	E1 24523	1.63	1EA 993 975-027	E4 6505	1.76	1F3 161 825-081	E1 1901	1.15, 1.21
1AE 003 427-011	E1 34548	1.63	1EA 993 975-027	E4 9471	1.76	1F4 002 608-001	E1 14521	1.12
1AE 003 427-021	E1 24523	1.63, 1.79	1EA 993 975-051	E4 6495	1.76	1F4 005 750-071	E1 44405	1.12
1AE 003 427-021	E1 34548	1.63, 1.79	1EA 993 975-051	E4 6505	1.76	1F4 005 750-101	E1 44404	1.12
1AE 003 427-151	E1 24523	1.64	1EA 993 975-051	E4 9471	1.76	1F4 005 750-611	E1 44404	1.12
1AE 003 427-161	E1 24523	1						



Type approval numbers

Part no.	Type approval no.	Page	Part no.	Type approval no.	Page	Part no.	Type approval no.	Page
1F7 004 700-431	E1 34553	1.17	1FE 158 877-011	E1 44444	1.33	1NE 002 537-201	E4 914	1.32
1F7 004 700-431	E1 348	1.17	1FE 161 576-011	E1 1741	1.34	1NE 006 300-011	E1 18231	1.33
1F8 006 800-191	E1 44484	1.18	1FE 161 641-011	E1 1655	1.34	1NE 006 300-051	E1 18231	1.33
1F8 006 800-221	E1 44484	1.19	1FE 161 641-021	E1 1655	1.34	1NE 006 300-101	E1 18231	1.33
1F8 006 800-301	E1 1928	1.18	1FE 161 642-011	E1 1655	1.34	1NE 008 773-031	E1 1689	1.34
1F8 006 800-311	E1 1928	1.18	1FE 161 644-011	E1 1655	1.34	1NE 138 555-011	E1 18231	1.33
1F8 006 800-321	E1 1928	1.19	1FJ 958 040-001	E24 0008	1.34	1NL 007 186-027	E1 20	1.37
1F8 006 800-331	E1 2254	1.19	1FJ 958 040-051	E24 0008	1.34	1NL 007 186-047	E1 20	1.37
1F8 006 800-341	E1 2254	1.18	1GO 357 000-001	E9 6400	1.194	1NL 007 186-061	E1 20	1.37
1F8 006 800-351	E1 2254	1.19	1GO 357 002-001	E6 0527	1.194	1NL 007 834-017	E1 548	1.54
1F8 006 800-361	E1 2254	1.18	1GA 357 001-001	E9 6402	1.194	1NL 007 834-057	E1 548	1.54
1F8 006 800-401	E1 1753	1.18	1KO 008 191-001	E1 917	1.42	1NL 008 090-031	E1 877	1.36
1F8 007 560-011	E1 303	1.22	1KO 008 191-007	E1 917	1.42	1NL 008 090-037	E1 877	1.36
1F8 007 560-041	E1 44484	1.22	1KO 008 191-011	E1 917	1.42	1NL 008 090-117	E1 877	1.36
1F8 007 560-051	E1 44484	1.24	1KO 008 191-017	E1 917	1.42	1NL 008 090-301	E1 877	1.37
1F8 007 560-131	E1 44484	1.24	1KO 008 191-021	E1 917	1.42	1NL 008 090-317	E1 877	1.38
1F8 007 560-201	E1 1753	1.23	1KO 008 191-027	E1 917	1.42	1NL 008 090-821	E1 877	1.36
1F8 007 560-211	E1 1753	1.23	1KO 008 191-041	E1 917	1.42	1SO 001 430-011	E1 352	1.69
1F8 007 560-301	E1 1928	1.22	1KO 008 191-047	E1 917	1.42	1SO 001 430-011	K 11103/1	1.69
1F8 007 560-311	E1 1928	1.24	1KO 008 191-212	E1 917	1.42	1S3 001 117-041	K 21032	1.69
1F8 007 560-321	E1 1928	1.24	1KO 008 191-227	E1 917	1.42	1S3 001 117-041	K 21037	1.69
1F8 007 560-331	E1 2254	1.24	1KO 008 192-001	E1 917	1.43	1S3 001 442-001	K 21047	1.68
1F8 007 560-341	E1 2254	1.24	1KO 008 192-007	E1 917	1.43	1TA 003 570-001	K 21090	1.67
1F8 007 560-401	E1 3099	1.22	1KO 008 192-011	E1 917	1.43	1TA 003 570-101	K 21090	1.75
1F8 007 560-411	E1 3099	1.24	1KO 008 192-017	E1 917	1.43	1TA 122 718-001	K 21090	1.67
1F8 007 560-421	E1 3099	1.24	1KO 008 192-027	E1 917	1.43	1VB 005 444-037	E1 21690	1.61
1F8 007 560-451	E1 3047	1.24	1KO 158 059-061	E1 917	1.43	1VB 005 444-037	E1 24460	1.61
1F8 007 560-561	E1 844	1.25	1KO 158 059-071	E1 917	1.43	1VB 005 444-037	E1 24461	1.61
1F8 007 560-571	E1 844	1.25	1KO 247 043-001	E1 2397	1.45	1VB 005 444-037	E1 24504	1.61
1F8 007 560-621	E1 2255	1.25	1KO 247 043-007	E1 2397	1.45	1VB 005 444-037	E1 7197	1.61
1F8 007 560-631	E1 2255	1.25	1KO 247 043-011	E1 2397	1.45	1VB 005 444-037	E1 7402	1.61
1F8 007 560-721	E1 2255	1.25	1KO 247 043-017	E1 2397	1.45	2BA 001 221-031	E1 32611	2.210
1F8 007 560-731	E1 2255	1.25	1KO 247 043-021	E1 2397	1.45	2BA 001 221-041	E1 32611	2.210
1F8 009 797-021	E1 1928	1.20	1KO 247 043-027	E1 2397	1.45	2BA 001 227-201	K 12642	2.208
1F8 009 797-031	E1 1928	1.20	1KO 247 043-031	E1 2397	1.45	2BA 001 227-211	K 12642	2.208
1F8 009 797-101	E1 1928	1.20	1KO 247 043-037	E1 2397	1.45	2BA 001 236-001	K 12749	2.213
1F8 009 797-111	E1 1928	1.20	1KO 247 043-117	E1 2397	1.47	2BA 001 240-301	E1 22786	2.104
1F8 009 797-121	E1 2254	1.20	1KO 247 043-117	E1 2398	1.47	2BA 001 244-001	K 12753	2.210
1F8 009 797-131	E1 2254	1.20	1KO 247 043-127	E1 2397	1.47	2BA 001 248-001	K 12793	2.208
1F8 009 797-321	E1 1928	1.20	1KO 247 043-127	E1 2398	1.47	2BA 001 259-611	K 23267	2.115
1F8 009 797-331	E1 1928	1.20	1KO 247 043-137	E1 2397	1.47	2BA 001 259-618	K 23267	2.115
1F8 009 797-341	E1 1928	1.20	1KO 247 043-137	E1 2398	1.47	2BA 001 263-001	K 22609	2.213
1F8 009 797-351	E1 1928	1.20	1KO 247 043-147	E1 2397	1.47	2BA 001 277-011	E1 22796	2.210
1F8 009 797-421	E1 1928	1.20	1KO 247 043-147	E1 2398	1.47	2BA 001 277-021	E1 22796	2.210
1F8 009 797-431	E1 1928	1.20	1KO 247 043-157	E1 2397	1.47	2BA 001 416-011	E1 32617	2.211
1F8 009 797-451	E1 3047	1.20	1KO 247 043-157	E1 2398	1.47	2BA 001 416-021	E1 32617	2.211
1F8 011 002-001	E1 3161	1.26	1KO 247 043-167	E1 2397	1.47	2BA 001 423-087	E1 42657	2.89
1F8 011 002-001	E1 6190	1.26	1KO 247 043-167	E1 2398	1.47	2BA 002 324-001	E1 32623	2.210
1F8 147 077-011	E1 44484	1.18	1K2 006 147-031	E1 34447	1.56	2BA 002 324-011	E1 32621	2.210
1F8 148 009-011	E1 303	1.22	1K2 006 147-051	E1 34447	1.56	2BA 002 324-021	E1 32621	2.210
1F8 148 131-011	E1 303	1.22, 1.24	1K3 114 155-001	E1 44464	1.59	2BA 002 652-101	E1 42763	2.209
1F8 149 644-011	E1 556	1.25	1KA 996 261-091	E4 10893	1.85	2BA 002 652-107	E1 42763	2.209
1F8 157 042-011	E1 44484	1.19	1KB 003 177-061	E1 24504	1.61	2BA 002 652-111	E1 42764	2.209
1F8 158 926-011	E1 44484	1.24	1KL 007 834-027	E1 549	1.54	2BA 002 652-117	E1 42764	2.209
1F8 161 326-011	E1 1753	1.18, 1.20, 1.23	1KL 007 834-067	E1 549	1.54	2BA 002 652-121	E1 42764	2.209
1F8 162 870-011	E1 1928	1.20, 1.22, 1.24	1KL 009 486-001	E1 2198	1.39	2BA 002 652-127	E1 42764	2.209
1F8 162 871-011	E1 1928	1.20, 1.24	1KL 998 570-021	E4 10892	1.40	2BA 002 939-251	E1 42788	2.211
1F8 162 872-011	E1 1928	1.18	1KL 998 570-031	E4 10892	1.40	2BA 003 014-011	E1 32619	2.119
1F8 162 873-011	E1 1928	1.18	1NO 008 582-001	E1 1342	1.40	2BA 003 014-111	E1 32661	2.119
1F8 162 874-011	E1 1928	1.19	1NO 008 582-007	E1 1342	1.40	2BA 003 022-001	E1 32719	2.208
1F8 165 940-011	E1 303	1.19	1NO 008 582-011	E1 1342	1.40	2BA 003 022-021	E1 32719	2.208
1F8 165 941-011	E1 303	1.18	1NO 008 582-017	E1 1342	1.40	2BA 003 022-037	E1 32719	2.208
1F8 165 942-011	E1 303	1.19	1NO 008 582-037	E1 1342	1.40	2BA 003 236-021	E1 32764	2.126
1F8 165 943-011	E1 303	1.18	1NO 009 295-011	E1 1951	1.10	2BA 003 236-027	E1 32764	2.126
1F8 165 946-011	E1 2254	1.20, 1.24	1NO 009 295-021	E1 1951	1.10	2BA 003 236-321	E1 32764	2.127
1F8 165 947-011	E1 303	1.20, 1.24	1NO 009 295-031	E1 1951	1.10	2BA 003 236-541	E1 63253	2.127
1F8 165 949-011	E1 2255	1.25	1NO 009 295-037	E1 1951	1.10	2BA 003 734-001	E1 42623	2.136
1FA 007 133-021	E1 122	1.29	1NO 009 295-041	E1 1951	1.10	2BA 003 734-061	E1 42641	2.136
1FA 007 133-021	E1 488	1.29	1NO 009 295-047	E1 1951	1.10	2BA 004 119-001	E1 42680	2.134
1FA 007 891-061	E1 651	1.28	1NO 009 295-057	E1 1951	1.10	2BA 004 119-017	E1 405	2.134
1FA 007 891-811	E1 651	1.28	1NO 009 295-067	E1 1951	1.10	2BA 005 200-311	E1 42770	2.128
1FA 007 891-841	E1 651	1.28	1NO 009 295-801	E1 1951	1.10	2BA 005 603-001	E1 42748	2.133
1FA 008 283-011	E1 1210	1.27	1NO 010 294-001	E1 2681	1.41	2BA 005 603-007	E1 42748	2.133
1FA 008 283-031	E1 1210	1.27	1NO 010 294-011	E1 2681	1.41	2BA 005 603-011	E1 42749	2.133
1FA 008 283-811	E1 1210	1.27	1NO 011 988-001	E1 3831	1.51	2BA 005 603-017	E1 42749	2.133
1FA 008 283-861	E1 1210	1.27	1NO 011 988-011	E1 3831	1.51	2BA 005 603-117	E1 586	2.133
1FA 008 284-011	E1 1212	1.27	1NO 011 988-051	E1 3832	1.51	2BA 007 135-001	E1 016	2.213
1FA 008 284-031	E1 1212	1.27	1NO 011 988-061	E1 3832	1.51	2BA 007 135-011	E1 016	2.213
1FA 008 284-811	E1 1212	1.27	1N4 002 608-021	E4 915	1.12	2BA 008 221-001	E1 878	2.77
1FA 008 284-861	E1 1212	1.27	1N4 005 750-041	E1 18213	1.12	2BA 008 221-007	E1 878	2.77
1FA 010 047-011	E1 2529	1.26	1N4 005 750-601	E1 18213	1.12	2BA 008 221-041	E1 1051	2.77
1FA 010 047-801	E1 2529	1.26	1N4 005 750-801	E1 18213	1.12	2BA 008 221-047	E1 1051	2.77
1FA 149 504-011	E1 651	1.28	1N4 007 893-001	E1 645	1.11	2BA 008 221-107	E1 878	2.77
1FB 005 860-031	E1 44442	1.30	1N4 007 893-821	E1 645	1.11	2BA 008 221-147	E1 1051	2.77
1FB 005 860-061	E1 44442	1.30	1N4 135 224-011	E1 18213	1.12	2BA 008 260-001	E1 989	2.212
1FB 005 860-831	E1 44442	1.30	1N4 149 531-011	E1 645	1.11	2BA 008 260-007	E1 989	2.212
1FB 007 892-011	E1 649	1.29	1N8 006 800-001	E1 18245	1.18	2BA 008 260-017	E1 989	2.212
1FB 007 892-071	E1 649	1.29	1N8 007 560-021	E1 18245	1.24	2BA 008 805-051	E4 10151	2.132
1FB 007 892-131	E1 649	1.29	1N8 007 560-031	E1 18245	1.22	2BA 008 805-057	E4 10151	2.132
1FB 007 892-811	E1 649	1.29	1N8 148 103-011	E1 18245	1.22	2BA 008 805-187	E4 10151	2.132
1FB 007 892-841	E1 649	1.29	1NA 007 133-001	E1 122	1.29	2BA 008 805-211	E4 10151	2.131
1FB 137 006-021	E1 44442	1.30	1NA 007 133-001	E1 488	1.29	2BA 008 805-257	E4 10151	2.132
1FB 149 519-011	E1 649	1.29	1NA 007 891-041	E1 650	1.28	2BA 008 982-041	E4 10880	2.130
1FD 003 590-411	E1 44410	1.31	1NA 007 891-821	E1 650	1.28	2BA 008 982-047	E4 10880	2.130
1FD 005 700-051	E1 44410	1.31	1NA 008 283-001	E1 1209	1.27	2BA 008 982-341	E4 10880	2.130
1FD 005 700-301	E1 44410	1.31	1NA 008 283-801	E1 1209	1.27	2BA 008 982-347	E4 10880	2.130
1FD 005 700-851	E1 44410	1.31	1NA 008 284-001	E1 1211	1.27	2BA 009 001-001	E4 6546	2.84
1FD 135 198-011	E1 44410	1.31	1NA 008 284-801	E1 1211	1.27	2BA 009 001-007	E4 6546	2.84
1FE 002 537-191								

Type approval numbers



Part no.	Type approval no.	Page	Part no.	Type approval no.	Page	Part no.	Type approval no.	Page
2BA 013 236-141	E1 3661	2.124	2BM 001 313-821	E1 32779	2.215	2DB 004 431-061	E1 32764	2.129
2BA 013 236-181	E1 3662	2.123	2BM 001 318-001	E1 32639	2.215	2JA 001 357-002	E1 8728	2.220
2BA 013 236-191	E1 3662	2.123	2BM 002 652-031	E1 42781	2.209	2JB 996 012-121	E12 23003	2.120
2BA 013 236-211	E1 3661	2.121	2BM 002 652-051	E1 32785	2.209	2KA 001 378-001	E1 12958	2.180
2BA 013 236-221	E1 3661	2.121	2BM 002 847-011	E1 32692	2.214	2KA 001 378-041	E1 12958	2.180
2BA 013 236-331	E1 3661	2.124	2BM 002 847-021	E1 32692	2.214	2KA 001 378-127	E1 12958	2.180
2BA 013 236-341	E1 3661	2.124	2BM 003 563-111	E1 42621	2.214	2KA 001 386-231	E1 12820	2.186
2BA 013 236-381	E1 3662	2.123	2BM 003 647-021	E1 151	2.214	2KA 001 386-281	E1 12820	2.186
2BA 013 236-391	E1 3662	2.123	2BM 003 647-067	E1 151	2.214	2KA 001 386-301	E1 12820	2.186
2BA 302 252-027	E4 10909	2.88	2BM 004 312-051	E1 42669	2.214	2KA 001 386-497	E1 12820	2.186
2BA 343 130-051	E4 6550	2.112	2BM 004 312-061	E1 42669	2.214	2KA 001 389-101	E1 12815	2.184
2BA 343 130-057	E4 6550	2.112	2BM 004 965-801	E1 42710	2.214	2KA 001 610-001	E1 12949	2.184
2BA 343 130-297	E4 6550	2.109	2BM 006 692-011	E1 52621	2.217	2KA 001 622-001	E1 12969	2.185
2BA 343 130-307	E4 6550	2.109	2BM 006 692-017	E1 52621	2.217	2KA 003 168-021	E1 22808	2.184
2BA 343 130-537	E4 6550	2.109	2BM 006 692-021	E1 52621	2.217	2KA 003 389-001	E1 22819	2.159
2BA 343 130-547	E4 6550	2.109	2BM 006 692-027	E1 52621	2.217	2KA 003 389-011	E1 22819	2.159
2BA 343 130-577	E4 6550	2.112	2BM 008 355-001	E1 1059	2.216	2KA 003 389-061	E1 22819	2.159, 2.327
2BA 343 130-587	E4 6550	2.112	2BM 008 355-007	E1 1059	2.216	2KA 003 389-062	E1 22819	2.159
2BA 343 390-071	E4 6550	2.106	2BM 008 355-017	E1 1848	2.216	2KA 003 389-068	E1 22819	2.159
2BA 344 130-747	E4 6550	2.107	2BM 008 771-001	E1 1423	2.215	2KA 003 389-081	E1 22819	2.159
2BA 344 169-191	E17 652	2.95	2BM 008 771-007	E1 1423	2.215	2KA 003 389-211	E1 22819	2.159
2BA 344 200-037	E4 12658	2.92, 2.313	2BM 009 320-807	E4 1365	2.214	2KA 003 389-217	E1 22819	2.159
2BA 357 025-011	E9 11523	2.348	2BM 340 825-201	E24 0066	2.265	2KA 003 738-057	E1 22916	2.180
2BA 357 026-021	E4 61200	2.354	2BM 340 825-207	E24 0066	2.265	2KA 004 331-061	E1 22848	2.180
2BA 357 027-021	E9 6652	2.355	2BM 340 825-211	E24 0066	2.265	2KA 004 331-067	E1 22848	2.180
2BA 357 028-021	E9 6571	2.356	2BM 340 825-217	E24 0066	2.265	2KA 004 331-107	E1 22890	2.180
2BA 357 029-031	E4 61970	2.349	2BM 340 825-301	E24 0066	2.265	2KA 004 525-001	E1 22861	2.184
2BA 357 029-131	E4 61970	2.349	2BM 340 825-307	E24 0066	2.265	2KA 005 049-008	E1 22871	2.180
2BA 959 011-301	E4 12373	2.90, 2.309	2BM 340 825-311	E24 0066	2.265	2KA 005 049-011	E1 22871	2.180
2BA 959 011-307	E4 12373	2.90, 2.309	2BM 340 825-317	E24 0066	2.265	2KA 005 049-017	E1 22871	2.180
2BA 959 822-601	E4 10208	2.103, 2.306	2BM 964 295-041	E17 651	2.153	2KA 006 896-001	E1 22910	2.184
2BA 959 932-051	E4 5851	2.212	2BM 964 295-047	E17 651	2.153	2KA 006 896-007	E1 22910	2.184
2BA 964 169-011	E17 648	2.100	2BN 344 169-097	E17 9801	2.101	2KA 007 929-001	E1 597	2.185
2BA 964 169-017	E17 648	2.100	2BN 344 169-107	E17 9801	2.101	2KA 007 929-007	E1 597	2.185
2BA 964 169-041	E17 9804	2.101	2BN 964 169-051	E17 9801	2.101	2KA 008 224-307	E1 979	2.181
2BA 964 169-047	E17 9804	2.101	2BN 964 169-057	E17 9801	2.101	2KA 010 278-011	E1 2609	2.181, 2.325
2BA 964 169-311	E17 652	2.95	2BN 964 169-247	E17 9801	2.101	2KA 010 278-017	E1 2609	2.181
2BA 964 169-501	E17 653	2.97	2BN 964 169-777	E17 9801	2.101	2KA 010 278-021	E1 2609	2.182, 2.325
2BA 964 169-507	E17 653	2.97	2BN 964 169-787	E17 9801	2.101	2KA 010 278-031	E1 2609	2.182, 2.325
2BA 965 039-021	E4 10215	2.87	2DA 001 240-341	E1 11551	2.104	2KA 010 278-051	E1 2609	2.182, 2.325
2BA 965 039-027	E4 10215	2.87	2DA 001 423-077	E1 21434	2.89	2KA 010 278-081	E1 2609	2.182
2BA 965 039-061	E4 10215	2.87	2DA 003 014-031	E1 242	2.118	2KA 010 278-111	E1 2911	2.181
2BA 965 039-067	E4 10215	2.87	2DA 003 014-037	E1 242	2.118	2KA 010 278-121	E1 2609	2.182
2BA 965 039-101	E4 10215	2.87	2DA 003 236-031	E1 240	2.126	2KA 010 278-311	E1 2609	2.181
2BA 965 039-107	E4 10215	2.87	2DA 003 236-037	E1 240	2.126	2KA 010 278-317	E1 2609	2.181
2BA 965 039-141	E4 10215	2.87	2DA 003 236-331	E1 240	2.127	2KA 010 278-321	E1 2609	2.182
2BA 965 039-147	E4 10215	2.87	2DA 003 734-011	E1 21406	2.135	2KA 010 278-411	E1 2609	2.181
2BA 980 607-201	E24 5850	2.66, 2.304	2DA 005 200-321	E1 241	2.28	2KA 010 278-421	E1 2609	2.182
2BA 980 607-701	E24 5850	2.66, 2.304	2DA 005 603-031	E1 31422	2.133	2KA 010 278-607	E1 2609	2.181, 2.325
2BA 980 888-011	E24 5891	2.140	2DA 005 603-037	E1 31422	2.133	2KA 010 278-617	E1 2609	2.181
2BA 980 888-211	E24 5891	2.140	2DA 005 739-111	E1 65	2.202	2KA 010 278-627	E1 2609	2.181, 2.325
2BA 980 888-311	E24 5869	2.140	2DA 005 739-117	E1 65	2.202	2KA 012 271-037	E1 47294	2.183, 2.326
2BA 980 888-411	E24 5869	2.140	2DA 007 421-001	E1 198	2.202	2KA 012 271-037	E24 0032	2.183, 2.326
2BA 980 888-511	E24 5890	2.140	2DA 007 421-007	E1 198	2.202	2KA 012 271-047	E1 47294	2.183, 2.326
2BA 980 888-611	E24 5890	2.140	2DA 007 421-017	E1 199	2.202	2KA 012 271-047	E24 0032	2.183, 2.326
2BA 996 012-061	E12 6041	2.120	2DA 007 421-027	E1 199	2.202	2KA 012 271-057	E1 47294	2.183, 2.326
2BA 996 012-071	E12 6041	2.120	2DA 007 428-001	E17 795	2.202	2KA 012 271-057	E24 0032	2.183, 2.326
2BA 996 012-147	E12 6041	2.120	2DA 007 428-007	E17 795	2.202	2KA 012 271-067	E1 47294	2.183, 2.326
2BA 996 027-001	E12 6060	2.211	2DA 007 541-001	E1 343	2.202	2KA 012 271-067	E24 0032	2.183, 2.326
2BA 997 027-031	E12 6044	2.139	2DA 007 858-037	E1 1224	2.203	2KA 012 271-077	E1 47294	2.183, 2.326
2BE 001 259-061	K 23269	2.114	2DA 008 136-007	E1 799	2.204	2KA 012 271-077	E24 0032	2.183, 2.326
2BE 001 278-011	K 23246	2.219	2DA 008 136-017	E1 799	2.204	2KA 012 271-087	E1 47294	2.183, 2.326
2BE 001 278-021	K 23246	2.219	2DA 008 136-027	E1 799	2.204	2KA 012 271-087	E24 0032	2.183, 2.326
2BE 002 582-031	E1 43388	2.67	2DA 008 136-031	E1 799	2.204	2KA 012 271-237	E1 47294	2.183, 2.326
2BE 002 776-251	E1 63225	2.72	2DA 008 221-167	E1 1049	2.77	2KA 012 271-237	E24 0032	2.183, 2.326
2BE 002 776-257	E1 63225	2.72	2DA 008 805-011	E4 10151	2.132	2KA 012 271-277	E1 47294	2.183, 2.326
2BE 002 776-261	E1 63225	2.72	2DA 008 805-017	E4 10151	2.132	2KA 012 271-277	E24 0032	2.183, 2.326
2BE 002 776-267	E1 63225	2.72	2DA 009 001-051	E4 7613	2.83	2KA 340 118-001	E1 534	2.334
2BE 003 014-251	E1 42712	2.119	2DA 009 001-057	E4 7613	2.83	2KA 340 828-001	E1 597	2.327
2BE 003 014-251	E1 53209	2.119	2DA 009 001-147	E4 7613	2.83	2KA 357 013-001	E9 1248	2.358
2BE 003 014-257	E1 42712	2.119	2DA 012 596-007	E1 4128	2.206	2KA 357 014-001	E9 1789	2.358
2BE 003 014-257	E1 53209	2.119	2DA 012 596-017	E1 4128	2.206	2KA 959 640-102	E4 2906	2.156
2BE 003 018-011	K 23237	2.73	2DA 012 596-027	E1 4127	2.206	2KA 959 640-607	E4 2906	2.156, 2.325
2BE 003 182-091	E1 53270	2.71	2DA 012 596-037	E1 4127	2.206	2KA 959 640-661	E4 4068	2.325
2BE 003 182-101	E1 53270	2.71	2DA 013 236-031	E1 3661	2.121	2KA 997 011-001	E12 4004	2.183
2BE 003 184-051	E1 102	2.68	2DA 013 236-151	E1 3661	2.123	2KA 997 011-011	E12 4004	2.183
2BE 003 184-051	E1 53254	2.68	2DA 013 236-231	E1 3661	2.121	2KA 997 011-021	E12 4033	2.183
2BE 003 184-061	E1 102	2.68	2DA 013 236-351	E1 3661	2.123	2KA 997 122-001	E12 4043	2.181
2BE 003 184-061	E1 53254	2.68	2DA 343 106-001	E4 7696	2.205	2KA 998 523-001	E12 4031	2.185
2BE 003 185-031	E1 53259	2.73	2DA 343 106-007	E4 7696	2.205	2KA 998 523-007	E12 4031	2.185
2BE 003 347-001	E1 53274	2.219	2DA 343 106-011	E4 7696	2.205	2NE 001 423-011	E1 8496	2.89, 2.307
2BE 004 119-021	E1 536	2.134	2DA 343 106-017	E4 7696	2.205	2NE 002 985-001	E1 8465	2.193
2BE 010 102-001	E1 2586	2.218	2DA 343 106-021	E4 7696	2.205	2NE 002 985-001	E1 8466	2.193
2BE 010 102-011	E1 2586	2.218	2DA 343 106-027	E4 7696	2.205	2NE 003 030-151	E1 18406	2.193
2BE 010 102-101	E1 2586	2.218	2DA 343 106-031	E4 7696	2.205	2NE 003 030-167	E1 18406	2.193
2BE 343 130-001	E4 10202	2.112	2DA 343 106-037	E4 7696	2.205	2NE 003 236-001	e1 18411	2.126
2BE 343 130-007	E4 10202	2.112	2DA 343 106-201	E4 7696	2.205	2NE 003 236-008	e1 18411	2.126
2BE 343 130-081	E4 10202	2.112	2DA 343 106-2					



Type approval numbers

Part no.	Type approval no.	Page	Part no.	Type approval no.	Page	Part no.	Type approval no.	Page
2NE 344 169-117	E17 9801	2.100	2PF 996 112-031	E12 7049	2.170	2PS 006 717-067	E17 378	2.138
2NE 344 200-061	E4 12371	2.92, 2.314	2PF 997 022-011	E12 7039	2.166	2PS 006 717-071	E1 86	2.138
2NE 344 200-061	E4 12658	2.92, 2.314	2PF 997 023-011	E12 7039	2.166	2PS 006 717-071	E17 378	2.138
2NE 344 200-061	E4 14198	2.92, 2.314	2PF 997 027-011	E12 7048	2.139	2PS 006 717-077	E1 86	2.138
2NE 344 200-091	E4 12658	2.92, 2.314	2PG 002 727-021	E4 23152	2.144	2PS 006 717-077	E17 378	2.138
2NE 344 200-091	E4 14198	2.92, 2.314	2PG 002 727-021	E4 468	2.144	2PS 007 943-011	E4 9417	2.161
2NE 344 200-091	E4 14198	2.92, 2.314	2PG 002 727-021	E4 469	2.144	2PS 007 943-017	E4 9417	2.161
2NE 344 200-097	E4 14198	2.92	2PG 003 057-011	E1 21629	2.116	2PS 007 943-021	E4 9417	2.161
2NE 344 610-007	E24 5857	2.196	2PG 003 057-011	E1 31315	2.116	2PS 007 943-027	E4 9417	2.161
2NE 344 610-037	E24 5857	2.196	2PG 003 057-061	E1 21629	2.116	2PS 007 943-311	E4 9417	2.161
2NE 357 026-031	E4 4052	2.354	2PG 003 057-061	E1 31315	2.116	2PS 007 943-317	E4 9417	2.161
2NE 357 027-031	E9 1184	2.355	2PG 003 057-067	E1 21629	2.116	2PS 007 943-321	E4 9417	2.161
2NE 357 028-031	E9 1158	2.356	2PG 003 057-067	E1 31315	2.116	2PS 007 972-011	E1 508	2.161
2NE 357 029-041	E4 4143	2.350	2PG 003 748-151	E1 21682	2.142, 2.264	2PS 007 972-017	E1 508	2.161
2NE 357 029-141	E4 4143	2.350	2PG 003 748-151	E1 31410	2.142, 2.264	2PS 008 138-001	E4 9110	2.161
2NE 959 011-501	E4 11391	2.91, 2.310	2PG 004 361-011	E4 23152	2.144	2PS 008 138-011	E4 9110	2.161
2NE 959 011-507	E4 11391	2.91, 2.310	2PG 004 361-011	E4 468	2.144	2PS 008 138-111	E4 9110	2.161
2NE 959 011-527	E4 11391	2.91	2PG 004 361-011	E4 469	2.144	2PS 008 138-801	E4 9110	2.161
2NE 959 821-201	E4 10208	2.103, 2.306	2PG 004 361-017	E4 23152	2.144	2PS 008 138-811	E4 9110	2.161
2NE 964 169-021	E17 3808	2.100	2PG 004 361-017	E4 468	2.144	2PS 008 138-821	E4 9110	2.161
2NE 964 169-027	E17 3808	2.100	2PG 004 361-017	E4 469	2.144	2PS 008 382-001	E4 3169	2.164
2NE 964 169-227	E17 3808	2.100	2PG 006 717-021	E17 378	2.138	2PS 008 382-007	E4 3169	2.164
2NE 964 169-341	E17 3810	2.96	2PG 006 717-021	E17 789	2.138	2PS 008 382-801	E4 3169	2.164
2NE 964 169-521	E17 3809	2.97	2PG 006 717-027	E17 378	2.138	2PS 008 382-811	E4 3169	2.164
2NE 964 169-527	E17 3809	2.97	2PG 006 717-027	E17 789	2.138	2PS 008 382-817	E4 3169	2.164
2NE 965 039-111	E4 10215	2.86	2PG 008 434-001	E17 0001	2.169	2PS 008 616-001	E1 1410	2.163, 2.266
2NE 965 039-117	E4 10215	2.86	2PG 008 645-321	E1 1395	2.262	2PS 008 616-011	E1 1410	2.163, 2.266
2NE 965 039-327	E4 10215	2.86	2PG 008 645-321	E1 1398	2.262	2PS 008 616-017	E1 1410	2.163, 2.266
2NE 980 889-501	E24 0010	2.141	2PG 008 645-331	E1 1395	2.262	2PS 008 643-007	E1 1429	2.162, 2.267
2NE 980 889-601	E24 0010	2.141	2PG 008 645-331	E1 1398	2.262	2PS 008 643-011	E1 1429	2.162, 2.267
2NE 996 012-021	E12 38007	2.120	2PG 008 645-541	E1 1395	2.149, 2.262	2PS 008 643-017	E1 1429	2.162, 2.267
2NR 344 169-441	E17 0069	2.96, 2.315	2PG 008 645-541	E1 1398	2.149, 2.262	2PS 008 643-021	E1 1429	2.162, 2.267
2NR 344 169-441	E24 5876	2.96, 2.315	2PG 008 645-561	E1 1395	2.149	2PS 008 643-027	E1 1429	2.162, 2.267
2NR 344 169-461	E17 0069	2.96, 2.315	2PG 008 645-561	E1 1398	2.149	2PS 008 643-031	E1 1429	2.162, 2.267
2NR 344 169-461	E24 5876	2.96, 2.315	2PG 008 645-567	E1 1395	2.149	2PS 008 643-037	E1 1429	2.162, 2.267
2NR 357 027-051	E9 1288	2.355	2PG 008 645-567	E1 1398	2.149	2PS 008 643-331	E1 1429	2.162, 2.267
2NR 357 029-061	E4 17063	2.350	2PG 008 645-631	E1 1395	2.149, 2.262	2PS 008 645-001	E1 1395	2.150, 2.268
2NR 357 029-161	E4 17063	2.350	2PG 008 645-631	E1 1398	2.149, 2.262	2PS 008 645-001	E1 1396	2.150, 2.268
2PF 001 259-631	E1 21624	2.114	2PG 008 645-641	E1 1395	2.149, 2.262	2PS 008 645-007	E1 1395	2.150
2PF 001 634-101	E1 11786	2.166	2PG 008 645-641	E1 1398	2.149, 2.262	2PS 008 645-007	E1 1396	2.150
2PF 001 638-011	E1 11779	2.168	2PG 008 645-831	E1 1395	2.149, 2.262	2PS 008 645-011	E1 1395	2.150
2PF 001 647-031	E1 21693	2.165	2PG 008 645-831	E1 1398	2.149, 2.262	2PS 008 645-011	E1 1396	2.150
2PF 001 647-037	E1 21693	2.165	2PG 008 645-917	E1 1395	2.149	2PS 008 645-017	E1 1395	2.150
2PF 001 648-161	E1 11794	2.170	2PG 008 645-917	E1 1398	2.149	2PS 008 645-017	E1 1396	2.150
2PF 001 648-171	E1 11794	2.170	2PG 008 645-961	E1 1395	2.149, 2.262	2PS 008 645-187	E1 1395	2.150
2PF 001 650-001	E1 11761	2.170	2PG 008 645-961	E1 1398	2.149, 2.262	2PS 008 645-187	E1 1396	2.150
2PF 002 985-291	E1 8712	2.193	2PG 008 645-967	E1 1395	2.149	2PS 008 645-301	E1 1395	2.268
2PF 003 014-071	E1 11793	2.119	2PG 008 645-967	E1 1398	2.149	2PS 008 645-301	E1 1396	2.268
2PF 003 014-301	E1 11793	2.119	2PG 008 645-971	E1 1395	2.149, 2.262	2PS 008 645-311	E1 1395	2.268
2PF 003 057-001	E1 21626	2.116	2PG 008 645-971	E1 1398	2.149, 2.262	2PS 008 645-311	E1 1396	2.268
2PF 003 057-041	E1 21626	2.116	2PG 008 645-977	E1 1395	2.149	2PS 008 645-361	E1 1395	2.268
2PF 003 389-037	E1 21639	2.160	2PG 008 645-977	E1 1398	2.149	2PS 008 645-361	E1 1396	2.268
2PF 003 389-041	E1 11592	2.160	2PG 011 422-091	E1 1395	2.149	2PS 008 645-497	E1 1395	2.150
2PF 003 563-151	E1 584	2.169	2PG 011 422-091	E1 1398	2.149	2PS 008 645-497	E1 1396	2.150
2PF 003 563-177	E1 584	2.169	2PG 011 422-277	E1 1395	2.149	2PS 008 645-507	E1 1395	2.150
2PF 003 563-187	E1 584	2.169	2PG 011 422-277	E1 1398	2.149	2PS 008 645-507	E1 1396	2.150
2PF 003 734-031	E1 21647	2.136	2PG 340 000-121	E1 2439	2.147	2PS 008 645-601	E1 1395	2.150
2PF 004 081-001	E1 21656	2.117	2PG 344 690-307	e17 30227	2.151	2PS 008 645-601	E1 1396	2.150
2PF 004 081-007	E1 21656	2.117	2PG 345 600-401	E24 5881	2.145, 2.264	2PS 008 645-607	E1 1395	2.150
2PF 004 081-017	E1 21656	2.117	2PG 345 600-411	E24 5881	2.145, 2.264	2PS 008 645-607	E1 1396	2.150
2PF 004 081-107	E1 21656	2.117	2PG 357 008-031	E9 1553	2.351	2PS 008 645-611	E1 1395	2.150, 2.268
2PF 006 679-007	E1 21691	2.166	2PG 357 009-021	E4 14800	2.352	2PS 008 645-611	E1 1396	2.150, 2.268
2PF 006 717-011	E17 803	2.138	2PG 357 009-121	E4 14800	2.352	2PS 008 645-621	E1 1395	2.150, 2.268
2PF 007 205-007	E4 453	2.169	2PG 357 010-021	E4 8114	2.352	2PS 008 645-621	E1 1396	2.150, 2.268
2PF 007 205-017	E4 453	2.169	2PG 357 010-121	E4 8114	2.352	2PS 008 645-717	E1 1395	2.150, 2.268
2PF 008 221-011	E1 879	2.78	2PG 357 011-021	E4 8638	2.357	2PS 008 645-717	E1 1396	2.150, 2.268
2PF 008 221-017	E1 879	2.78	2PG 357 012-021	E9 1280	2.353	2PS 008 645-787	E1 1395	2.150, 2.268
2PF 008 221-177	E1 879	2.78	2PG 962 964-041	E4 3153	2.137	2PS 008 645-787	E1 1396	2.150, 2.268
2PF 008 405-051	E1 1696	2.74	2PG 962 964-041	E4 7499	2.137	2PS 008 645-797	E1 1395	2.150, 2.268
2PF 008 405-057	E1 1696	2.74	2PG 962 964-051	E4 3153	2.137	2PS 008 645-797	E1 1396	2.150, 2.268
2PF 008 405-061	E1 1696	2.74, 2.234	2PG 962 964-051	E4 7499	2.137	2PS 008 645-891	E1 1395	2.150, 2.268
2PF 008 405-067	E1 1696	2.74	2PG 962 964-057	E4 3153	2.137	2PS 008 645-891	E1 1396	2.150, 2.268
2PF 008 405-127	E1 1696	2.74	2PG 962 964-057	E4 7499	2.137	2PS 008 645-981	E1 1395	2.150
2PF 009 001-081	E4 7613	2.83	2PG 963 959-021	E17 9705	2.143	2PS 008 645-981	E1 1396	2.150
2PF 009 001-177	E4 7613	2.83	2PG 963 959-027	E17 9705	2.143	2PS 008 645-991	E1 1395	2.150, 2.268
2PF 009 001-421	E4 12390	2.81	2PG 964 295-011	E17 9806	2.154	2PS 008 645-991	E1 1396	2.150, 2.268
2PF 009 001-521	E4 12390	2.81	2PG 964 295-017	E17 9806	2.154	2PS 009 226-007	E4 10236	2.158
2PF 009 226-097	E11 3016	2.158	2PG 964 295-111	E17 0301	2.154	2PS 009 226-017	E4 10236	2.158
2PF 009 514-001	E1 2300	2.165, 2.264	2PG 964 295-117	E17 0301	2.154	2PS 009 226-021	E4 10236	2.158
2PF 009 514-011	E1 2300	2.165, 2.264	2PG 964 295-121	E17 0301	2.154	2PS 009 226-027	E4 10236	2.158
2PF 340 000-111	E1 2439	2.147	2PG 964 295-127	E17 0301	2.154	2PS 009 226-031	E4 10236	2.158
2PF 340 825-001	E4 11371	2.263	2PS 002 727-001	E4 0002	2.144	2PS 009 226-037	E4 10236	2.158
2PF 340 825-057	E4 11371	2.263	2PS 002 727-001	E4 0003	2.144	2PS 009 226-067	E4 10236	2.158
2PF 959 570-202	E24 0051	2.167, 2.263	2PS 002 727-001	E4 23152	2.144	2PS 009 226-077	E1 4011	2.158
2PF 959 570-207	E24 0051	2.167	2PS 003 057-051	E1 280	2.116	2PS 009 226-087	E1 4011	2.158
2PF 959 570-212	E24 0051	2.167, 2.263	2PS 003 057-051	E1 31315	2.116	2PS 009 226-147	E4 10236	2.158
2PF 959 570								

Type approval numbers



Part no.	Type approval no.	Page	Part no.	Type approval no.	Page	Part no.	Type approval no.	Page
2PS 345 600-051	E24 5881	2.146	2RL 007 017-051	e1 3486	3.18	2RL 008 065-011	e1 1740	3.13
2PS 345 600-057	E24 5881	2.146	2RL 007 017-051	E4 6510	3.18	2RL 008 065-101	e1 1243	3.13
2PS 345 600-061	E24 5881	2.145	2RL 007 017-061	e1 3486	3.18	2RL 008 065-101	e1 1740	3.13
2PS 345 600-071	E24 5881	2.145, 2.270	2RL 007 017-061	E4 6511	3.18	2RL 008 065-107	e1 1243	3.13
2PS 345 600-077	E24 5881	2.145	2RL 007 017-071	e1 3486	3.18	2RL 008 065-107	e1 1740	3.13
2PS 345 600-091	E24 5881	2.146	2RL 007 017-071	E4 6511	3.18	2RL 008 065-111	e1 1243	3.13
2PS 345 600-101	E24 5881	2.146	2RL 007 337-001	e1 2181	3.04	2RL 008 065-111	e1 1740	3.13
2PS 345 600-111	E24 5881	2.146	2RL 007 337-001	E4 6509	3.04	2RL 008 181-001	e1 1399	3.16
2PS 345 600-137	E24 5881	2.145	2RL 007 337-011	e1 2181	3.04	2RL 008 181-001	e1 1889	3.16
2PS 345 600-157	E24 5881	2.145	2RL 007 337-011	E4 6509	3.04	2RL 008 181-011	e1 1399	3.16
2PS 345 600-167	E24 5881	2.145	2RL 007 337-021	e1 2181	3.05	2RL 008 181-011	e1 1889	3.16
2PS 345 600-177	E24 5881	2.145	2RL 007 337-021	E4 6509	3.05	2RL 008 181-101	e1 1399	3.16
2PS 345 600-197	E24 5881	2.145	2RL 007 337-031	e1 2181	3.05	2RL 008 181-101	e1 1889	3.16
2PS 357 008-001	E9 1553	2.351	2RL 007 337-031	E4 6509	3.05	2RL 008 181-111	e1 1399	3.16
2PS 357 008-011	E9 1553	2.351	2RL 007 337-041	e1 2181	3.04	2RL 008 181-111	e1 1889	3.16
2PS 357 009-001	E4 14802	2.352	2RL 007 337-041	E4 6509	3.04	2RL 008 182-001	e1 1399	3.17
2PS 357 009-101	E4 14802	2.352	2RL 007 337-057	E4 6509	3.05	2RL 008 182-001	e1 1889	3.17
2PS 357 010-001	E4 9194	2.352	2RL 007 337-057	K 18614	3.05	2RL 008 182-011	e1 1399	3.17
2PS 357 010-101	E4 9194	2.352	2RL 007 337-101	e1 2181	3.04	2RL 008 182-011	e1 1889	3.17
2PS 357 011-001	E4 9206	2.357	2RL 007 337-101	E4 6513	3.04	2RL 008 182-101	e1 1399	3.17
2PS 357 012-001	E9 1280	2.353	2RL 007 337-111	e1 2181	3.04	2RL 008 182-101	e1 1889	3.17
2PS 959 788-002	E24 004	2.156	2RL 007 337-111	E4 6513	3.04	2RL 008 182-111	e1 1399	3.17
2PS 962 964-012	E4 0004	2.137	2RL 007 337-121	e1 2181	3.05	2RL 008 182-111	e1 1889	3.17
2PS 962 964-012	E4 3153	2.137	2RL 007 337-121	E4 6513	3.05	2RL 008 183-001	e1 1399	3.17
2PS 962 964-018	E4 0004	2.137	2RL 007 550-001	e1 2182	3.07	2RL 008 183-001	e1 1889	3.17
2PS 962 964-018	E4 3153	2.137	2RL 007 550-001	E4 6514	3.07	2RL 008 183-011	e1 1399	3.17
2PS 962 964-031	E4 0004	2.137	2RL 007 550-011	e1 2182	3.07	2RL 008 183-011	e1 1889	3.17
2PS 962 964-031	E4 3153	2.137	2RL 007 550-011	E4 6514	3.07	2RL 008 183-101	e1 1399	3.17
2PS 962 964-037	E4 0004	2.137	2RL 007 550-021	e1 2182	3.07	2RL 008 183-101	e1 1889	3.17
2PS 962 964-037	E4 3153	2.137	2RL 007 550-021	E4 6514	3.07	2RL 008 183-111	e1 1399	3.17
2PS 963 959-001	E17 9704	2.143, 2.270	2RL 007 551-001	e1 2182	3.08	2RL 008 183-111	e1 1889	3.17
2PS 963 959-007	E17 9704	2.143	2RL 007 551-001	E4 6514	3.08	2RL 008 364-021	e1 1289	3.09
2PS 963 959-011	E17 9704	2.143, 2.270	2RL 007 551-011	e1 2182	3.08	2RL 008 364-021	e1 1774	3.09
2PS 963 959-017	E17 9704	2.143	2RL 007 551-011	E4 6514	3.08	2RL 008 366-021	e1 1290	3.16
2PS 964 295-001	E17 9807	2.153	2RL 007 551-021	e1 2182	3.08	2RL 008 366-021	e1 1775	3.16
2PS 964 295-007	E17 9807	2.153	2RL 007 551-021	E4 6514	3.08	2RL 008 366-031	e1 1290	3.16
2PS 964 295-011	E17 0202	2.153	2RL 007 552-001	e1 2182	3.08	2RL 008 366-031	e1 1775	3.16
2PS 964 295-057	E17 0202	2.153	2RL 007 552-001	E4 6514	3.08	2RL 008 965-001	e1 1419	3.05
2PS 964 295-067	E17 0202	2.153	2RL 007 552-011	e1 2182	3.08	2RL 008 965-001	e1 2954	3.05
2PS 964 295-077	E17 0202	2.153	2RL 007 552-011	E4 6514	3.08	2RL 008 965-011	e1 1419	3.05
2PS 964 295-081	E17 0202	2.153	2RL 007 552-021	e1 2182	3.08	2RL 008 965-011	e1 2954	3.05
2PS 964 295-081	E17 0202	2.153	2RL 007 552-021	E4 6514	3.08	2RL 008 965-021	e1 1419	3.05
2PS 964 295-347	E17 0202	2.153	2RL 007 553-001	e1 2182	3.09	2RL 008 965-021	e1 2954	3.05
2PS 964 295-357	E17 0202	2.153	2RL 007 553-001	E4 6514	3.09	2RL 008 965-031	e1 2140	3.05
2PT 008 362-801	E1 1032	2.171	2RL 007 553-011	e1 2182	3.09	2RL 008 965-031	e1 2954	3.05
2PT 008 935-001	E1 1722	2.171	2RL 007 553-021	E4 6514	3.09	2RL 008 965-041	e1 2140	3.05
2PT 008 935-011	E1 1722	2.171	2RL 007 553-021	e1 2182	3.09	2RL 008 965-041	e1 2954	3.05
2PT 008 935-801	E1 1722	2.171	2RL 007 553-021	E4 6514	3.09	2RL 008 966-001	e1 1419	3.06
2PT 009 496-007	E1 2344	2.179	2RL 007 900-001	E1 817	3.57	2RL 008 966-001	e1 2954	3.06
2PT 009 496-801	E1 2344	2.179	2RL 007 900-121	e1 1309	3.59	2RL 008 966-021	e1 1419	3.06
2PT 009 599-111	E1 2372	2.175	2RL 007 900-121	E1 6517	3.59	2RL 008 966-021	e1 2954	3.06
2PT 010 043-011	E1 2578	2.176	2RL 007 900-151	E1 817	3.57	2RL 008 966-031	e1 2140	3.06
2PT 010 043-021	E1 2578	2.176	2RL 007 900-171	e1 817	3.59	2RL 008 966-031	e1 2954	3.06
2PT 010 043-031	E1 2578	2.176	2RL 007 900-171	e1 1309	3.57	2RL 008 967-001	e1 1419	3.06
2PT 010 043-041	E1 2578	2.176	2RL 007 900-191	E1 817	3.57	2RL 008 967-001	e1 2954	3.06
2PT 010 043-801	E1 2578	2.176	2RL 007 900-191	E1 817	3.57	2RL 008 967-011	e1 1419	3.06
2PT 010 047-201	E1 2529	2.171	2RL 007 900-201	E1 817	3.57	2RL 008 967-011	e1 2954	3.06
2PT 010 047-821	E1 2529	2.171	2RL 007 900-211	E1 817	3.57	2RL 008 967-021	e1 1419	3.06
2PT 010 458-701	E24 5852	2.172	2RL 007 900-221	e1 1309	3.59	2RL 008 967-021	e1 2954	3.06
2PT 010 458-711	E24 5852	2.172	2RL 007 900-221	E1 6517	3.59	2RL 008 967-031	e1 2140	3.06
2PT 010 458-721	E24 5852	2.172	2RL 007 900-241	e1 1309	3.59	2RL 008 967-031	e1 2954	3.06
2PT 010 458-731	E24 5852	2.172	2RL 007 900-241	E1 6517	3.59	2RL 008 967-041	e1 2140	3.06
2PT 010 458-741	E24 5852	2.173	2RL 007 900-251	E1 817	3.57	2RL 008 967-041	e1 2954	3.06
2PT 010 458-751	E24 5852	2.173	2RL 007 900-291	e1 1309	3.57	2RL 008 967-041	e1 2954	3.06
2PT 010 458-761	E24 5852	2.173	2RL 007 900-291	E1 817	3.57	2RL 008 990-021	e1 1419	3.07
2PT 010 458-771	E24 5852	2.173	2RL 007 900-291	E1 817	3.57	2RL 008 990-021	e1 2954	3.07
2PT 010 458-781	E24 5852	2.173	2RL 007 900-501	e1 1309	3.59	2RL 010 743-001	e1 2989	3.35
2PT 010 458-781	E24 5852	2.173	2RL 007 900-501	E1 817	3.56	2RL 010 743-001	e1 35947	3.35
2PT 177 696-701	E24 5852	2.172	2RL 007 900-511	e1 1309	3.56	2RL 010 743-011	e1 2989	3.35
2PT 177 696-711	E24 5852	2.172	2RL 007 900-511	E1 817	3.56	2RL 010 743-011	e1 35947	3.35
2PT 177 696-721	E24 5852	2.172	2RL 007 900-521	e1 1309	3.56	2RL 010 743-021	e1 2989	3.35
2PT 177 696-731	E24 5852	2.172	2RL 007 900-521	E1 817	3.56	2RL 010 743-021	e1 35947	3.35
2PT 177 696-761	E24 5852	2.173	2RL 007 900-601	E1 817	3.57	2RL 010 743-031	e1 2989	3.35
2PT 177 696-771	E24 5852	2.173	2RL 007 900-611	E1 817	3.57	2RL 010 743-031	e1 35947	3.35
2PT 965 039-171	E4 10215	2.87	2RL 007 900-631	e1 1309	3.59	2RL 010 743-041	e1 2989	3.35
2PT 965 039-177	E4 10215	2.87	2RL 007 900-631	E1 6517	3.59	2RL 010 743-041	e1 35947	3.35
2PT 980 680-001	E24 0001	2.176	2RL 007 900-681	e1 1309	3.59	2RL 010 743-051	e1 2989	3.35
2PT 980 680-101	E24 0001	2.177	2RL 007 900-681	E1 817	3.59	2RL 010 743-051	e1 35947	3.35
2PT 980 680-501	E24 0001	2.176	2RL 007 900-701	E4 6516	3.58	2RL 010 743-061	e1 35947	3.35
2PT 980 680-601	E24 0001	2.177	2RL 008 060-001	E1 1240	3.11	2RL 010 743-061	E12989	3.35
2PT 980 680-801	E24 0001	2.176	2RL 008 060-001	e1 1740	3.11	2RL 010 743-071	e1 2989	3.35
2PT 980 680-821	E24 0001	2.177	2RL 008 060-011	E1 1240	3.11	2RL 010 743-071	e1 35947	3.35
2PT 980 680-851	E24 0001	2.176	2RL 008 060-011	e1 1740	3.11	2RL 010 743-081	e1 2989	3.35
2PT 980 690-601	E24 5854	2.175	2RL 008 060-101	E1 1241	3.11	2RL 010 743-081	e1 35947	3.35
2PT 980 691-601	E24 5854	2.175	2RL 008 060-101	e1 1740	3.11	2RL 010 743-091	e1 2989	3.35
2PT 980 789-051	E24 5864	2.174	2RL 008 060-111	E1 1241	3.11	2RL 010 743-091	e1 35947	3.35
2PT 980 789-061	E24 5864	2.174	2RL 008 060-111	e1 1740	3.11	2RL 010 743-101	e1 2989	3.35
2PT 980 789-251	E24 5864	2.174	2RL 008 061-001	E1 1240	3.10	2RL 010 743-101	e1 35947	3.35
2PT 980 789-261	E24 5864	2.174	2RL 008 061-001	e1 1740	3.10	2RL 010 743-111	e1 2989	3.35
2PT 980 789-851	E24 5864	2.174	2RL 008 061-011	E1 1240	3.10	2RL 010 743-111	e1 35947	3.35
2PT 980 789-861	E24 5864	2.174	2RL					



Type approval numbers

Part no.	Type approval no.	Page	Part no.	Type approval no.	Page	Part no.	Type approval no.	Page
2SA 001 240-331	E1 11550	2.104	2SB 980 606-701	E24 5850	2.65, 2.303	2SD 343 390-407	E4 11785	2.105
2SA 001 259-751	E1 31438	2.113	2SB 980 887-011	E24 5891	2.140	2SD 343 390-417	E4 11785	2.105
2SA 001 259-757	E1 31438	2.113	2SB 980 887-211	E24 5891	2.140	2SD 343 390-707	E4 11785	2.105
2SA 001 634-121	E1 31416	2.166	2SD 001 305-021	K 33265	2.54	2SD 343 440-017	E17 0501	2.41
2SA 001 638-021	E1 31450	2.168	2SD 001 306-061	K 33375	2.53	2SD 343 440-047	E17 0501	2.41
2SA 001 647-041	K 11580	2.165	2SD 001 679-001	K 53397	2.63	2SD 343 910-001	e1 5109	2.52
2SA 003 014-051	E1 31418	2.118	2SD 001 680-271	E1 31482	2.28	2SD 343 910-001	E4 12393	2.52
2SA 003 057-021	E1 11584	2.116	2SD 001 680-271	E1 43322	2.28	2SD 343 910-017	E4 12393	2.52
2SA 003 236-041	E1 11591	2.126	2SD 001 680-271	E1 53335	2.28	2SD 344 100-001	E4 13136	2.60, 2.311
2SA 003 236-047	E1 11591	2.126	2SD 001 680-281	E1 31482	2.28	2SD 344 100-101	E4 13136	2.60, 2.311
2SA 003 236-048	E1 11591	2.126	2SD 001 680-281	E1 43322	2.28	2SD 344 169-137	E17 9903	2.98
2SA 003 236-341	E1 11591	2.126	2SD 001 680-281	E1 53335	2.28	2SD 344 169-147	E17 9903	2.98
2SA 003 734-121	E1 31433	2.135	2SD 001 680-391	E1 31482	2.28	2SD 344 169-237	E17 9903	2.98
2SA 004 431-071	e1 18411	2.129	2SD 001 680-391	E1 43322	2.28	2SD 344 169-247	E17 9903	2.98
2SA 004 431-071	E1 31443	2.129	2SD 001 680-391	E1 53335	2.28	2SD 344 200-001	E4 12371	2.91, 2.312
2SA 005 200-331	E1 31443	2.128	2SD 001 680-401	E1 31482	2.28	2SD 344 200-001	E4 12658	2.91, 2.312
2SA 005 603-021	E1 31423	2.133	2SD 001 680-401	E1 43322	2.28	2SD 344 200-001	E4 14198	2.91, 2.312
2SA 005 603-027	E1 31423	2.133	2SD 001 680-401	E1 53335	2.28	2SD 344 200-071	E4 12371	2.91, 2.312
2SA 006 679-027	E1 31470	2.166	2SD 001 685-211	E12 7146	2.62, 2.308	2SD 344 200-071	E4 12658	2.91, 2.312
2SA 006 717-001	E17 804	2.138	2SD 001 685-218	E12 7146	2.62	2SD 344 200-077	E4 12371	2.91
2SA 006 717-007	E17 804	2.138	2SD 001 685-231	E12 7146	2.62, 2.308	2SD 344 200-077	E4 12658	2.91
2SA 008 221-127	E1 1048	2.77	2SD 001 685-232	E12 7146	2.62	2SD 344 200-311	E4 12371	2.93, 2.312
2SA 008 405-011	E1 1197	2.74	2SD 001 685-277	E12 7146	2.62	2SD 344 200-311	E4 12658	2.93, 2.312
2SA 008 405-017	E1 1197	2.74	2SD 001 685-307	E12 7136	2.61	2SD 357 022-011	E9 11491	2.345
2SA 008 405-021	E1 1197	2.74	2SD 001 685-307	E12 7176	2.61	2SD 357 024-001	E9 6135	2.340
2SA 008 405-027	E1 1197	2.74	2SD 001 685-317	E12 7146	2.62	2SD 357 026-001	E4 13992	2.354
2SA 008 805-001	E4 10151	2.132	2SD 001 685-347	E17 0102	2.61, 2.308	2SD 357 027-001	E9 6653	2.355
2SA 008 805-007	E4 10151	2.132	2SD 001 686-101	E1 43261	2.63	2SD 357 028-001	E9 6650	2.356
2SA 009 001-137	E4 7613	2.83	2SD 001 688-141	E1 43207	2.24	2SD 357 029-001	E4 17064	2.349
2SA 013 236-041	E1 3661	2.121	2SD 001 688-171	E1 43207	2.24	2SD 357 029-011	E4 17064	2.349
2SA 013 236-161	E1 3661	2.123	2SD 001 693-011	E1 31436	2.45	2SD 357 031-001	E9 6512	2.340
2SA 013 236-241	E1 3661	2.121	2SD 001 693-011	E1 53234	2.45	2SD 357 033-001	E9 1966	2.345
2SA 013 236-361	E1 3661	2.123	2SD 001 699-061	E1 196	2.28	2SD 959 010-401	E9 1538	2.90, 2.309
2SA 961 167-011	E1 31468	2.165	2SD 001 699-061	E1 43332	2.28	2SD 959 010-407	E9 1538	2.90, 2.309
2SA 962 964-091	E4 7507	2.137	2SD 001 699-511	E1 196	2.28	2SD 959 050-401	E4 10176	2.64, 2.302
2SA 964 169-091	E17 810	2.98	2SD 001 699-511	E1 43332	2.28	2SD 959 050-401	e4 1586	2.98
2SA 964 169-097	E17 810	2.98	2SD 002 514-161	E1 213	2.55	2SD 964 169-111	E17 9903	2.98
2SA 964 169-277	E17 810	2.98	2SD 002 514-161	E1 43331	2.55	2SD 964 169-111	E17 9903	2.98
2SA 965 039-001	E4 10215	2.86	2SD 002 582-011	E1 116	2.67	2SD 964 169-331	E4 9823	2.95
2SA 965 039-081	E4 10215	2.86	2SD 002 582-017	E1 116	2.67	2SD 964 169-401	E17 9823	2.95
2SA 965 039-087	E4 10215	2.86	2SD 002 582-021	E1 116	2.67	2SD 964 169-411	E17 9823	2.95
2SA 965 039-307	E4 10215	2.86	2SD 002 582-027	E1 116	2.67	2SD 964 169-421	E17 9823	2.95
2SA 965 012-091	E12 7075	2.120	2SD 002 776-231	E1 273	2.72	2SD 980 602-211	E4 2901	2.65, 2.303
2SA 997 022-001	E12 7039	2.166	2SD 002 776-231	E1 63230	2.72	2SD 980 613-211	E4 2901	2.65, 2.303
2SA 997 023-001	E12 7039	2.166	2SD 002 776-237	E1 273	2.72	2SD 986 030-021	E12 4054	2.54
2SA 997 027-001	E12 7048	2.139	2SD 002 776-237	E1 63230	2.72	2SD 986 030-021	E12 7133	2.54
2SB 001 240-311	E1 11549	2.104	2SD 002 776-241	E1 273	2.72	2SD 997 006-021	E12 6040	2.70
2SB 001 259-261	K 23270	2.113	2SD 002 776-241	E1 63230	2.72	2SD 997 006-031	E12 6040	2.70
2SB 001 301-021	K 23318	2.63	2SD 002 776-247	E1 273	2.72	2SD 997 006-031	E12 7058	2.70
2SB 001 423-097	E1 681	2.89	2SD 002 776-247	E1 63230	2.72	2SD 997 006-031	E12 7058	2.70
2SB 001 673-002	K 23256/1	2.63	2SD 003 167-011	E1 264	2.36, 2.285	2SD 997 131-051	E12 6089	2.69
2SB 003 014-151	E1 31453	2.118	2SD 003 167-011	E1 53250	2.36, 2.285	2SD 997 131-051	E12 7114	2.69
2SB 003 018-031	K 23260/1	2.73	2SD 003 167-021	E1 264	2.36, 2.285	2SD 997 131-367	E12 6089	2.69
2SB 004 460-061	E17 9101	2.37	2SD 003 167-021	E1 53250	2.36, 2.285	2SD 997 131-367	E12 7114	2.69
2SB 005 603-137	E1 340	2.133	2SD 003 167-521	E1 53250	2.36	2SD 998 531-057	E12 6046	2.53
2SB 008 405-091	E1 1892	2.74	2SD 003 167-531	E1 264	2.36	2SD 998 531-057	E12 7064	2.53
2SB 008 405-101	E1 1892	2.74	2SD 003 167-541	E1 264	2.36	2SD 998 531-067	E12 6046	2.53
2SB 008 805-021	E4 10151	2.132	2SD 003 182-051	E1 31445	2.71	2SD 998 531-067	E12 7064	2.53
2SB 008 805-027	E4 10151	2.132	2SD 003 182-051	E1 53257	2.71	2SE 001 306-051	K 33375	2.53
2SB 008 805-201	E4 10151	2.131	2SD 003 182-057	E1 31445	2.71	2SE 001 679-051	K 43322	2.63
2SB 008 805-237	E4 10151	2.132	2SD 003 182-057	E1 53257	2.71	2SE 001 679-051	K 53397	2.63
2SB 008 982-001	E4 10880	2.130	2SD 003 182-061	E1 31445	2.71	2SE 001 680-291	E1 31482	2.28
2SB 008 982-007	E4 10880	2.130	2SD 003 182-061	E1 53257	2.71	2SE 001 680-291	E1 43322	2.28
2SB 008 982-367	E4 10880	2.130	2SD 003 182-067	E1 31445	2.71	2SE 001 680-291	E1 53335	2.28
2SB 009 001-061	E4 7613	2.83	2SD 003 182-067	E1 53257	2.71	2SE 001 680-301	E1 31482	2.28
2SB 009 001-067	E4 7613	2.83	2SD 003 184-031	E1 130	2.68	2SE 001 680-301	E1 43322	2.28
2SB 009 001-157	E4 7613	2.83	2SD 003 184-031	E1 53253	2.68	2SE 001 680-301	E1 53335	2.28
2SB 009 001-401	E4 12390	2.81	2SD 003 184-037	E1 130	2.68	2SE 001 685-201	E12 7146	2.62, 2.308
2SB 009 001-501	E4 12390	2.81	2SD 003 184-037	E1 53253	2.68	2SE 001 685-221	E12 7146	2.62, 2.308
2SB 009 362-011	E4 7747	2.79	2SD 003 184-041	E1 130	2.68	2SE 001 685-227	E12 7146	2.62
2SB 009 362-011	E4 7748	2.79	2SD 003 184-041	E1 53253	2.68	2SE 001 686-142	E1 43261	2.63
2SB 009 362-021	E4 7747	2.79	2SD 003 184-047	E1 130	2.68	2SE 001 688-151	E1 43207	2.24
2SB 009 362-021	E4 7748	2.79	2SD 003 184-047	E1 53253	2.68	2SE 001 688-161	E1 43207	2.24
2SB 009 362-041	E4 7747	2.79	2SD 003 409-327	E1 53288	2.45	2SE 001 699-071	E1 196	2.28
2SB 009 362-041	E4 7748	2.79	2SD 003 409-327	E2 164	2.45	2SE 001 699-071	E1 43332	2.28
2SB 009 362-067	E4 7747	2.79	2SD 004 431-011	E1 243	2.129	2SE 002 514-171	E1 43331	2.55
2SB 009 362-067	E4 7748	2.79	2SD 004 431-011	E1 32764	2.129	2SE 002 514-171	E1 43370	2.55
2SB 013 236-071	E1 3662	2.121	2SD 004 460-001	E17 9301	2.37	2SE 002 578-701	E1 9401	2.55
2SB 013 236-171	E1 3662	2.123	2SD 004 460-011	E17 9301	2.37	2SE 002 578-707	E1 43370	2.55
2SB 013 236-271	E1 3662	2.121	2SD 004 460-017	E17 9301	2.37	2SE 002 578-707	E17 9401	2.55
2SB 013 236-371	E1 3661	2.123	2SD 004 623-028	E17 630	2.54	2SE 002 582-071	E1 116	2.67
2SB 302 252-057	E4 10909	2.88	2SD 004 623-028	E17 763	2.54	2SE 002 582-071	E1 53345	2.67
2SB 343 130-027	E4 7698	2.111	2SD 006 040-031	E13 9385	2.33	2SE 002 776-211	E1 273	2.72
2SB 343 130-757	E4 7698	2.111	2SD 006 040-037	E13 9385	2.33	2SE 002 776-217	E1 63230	2.72
2SB 343 130-767	E4 7698	2.111	2SD 006 040-041	E13 9385	2.34	2SE 002 776-221	E1 273	2.72
2SB 343 390-091	E4 7698	2.106	2SD 006 040-131	E13 9385	2.34	2SE 002 776-221	E1 63230	2.72
2SB 343 400-317	E17 822	2.108	2SD 006 040-137	E13 9385	2.34	2SE 003 167-031	E1 264	2.36, 2.285
2SB 343 400-327	E17 822	2.108	2SD 006 040-141	E13 9385	2.34	2SE 003 167-041	E1 264	2.36, 2.285
2SB 344 200-027	E4 12658	2.92, 2.312	2SD 006 040-147	E13 9385	2.3			

Type approval numbers



Part no.	Type approval no.	Page	Part no.	Type approval no.	Page	Part no.	Type approval no.	Page
2SE 006 040-011	E13 9385	2.33	2SL 007 547-067	E6 451	2.35	2VA 997 113-001	E12 3021	2.46
2SE 007 547-011	E6 450	2.35	2SL 007 547-067	E6 452	2.35	2VA 997 113-001	E12 6077	2.46
2SE 007 547-011	E6 451	2.35	2ST 001 259-321	K 23270	2.113	2VA 997 113-001	E12 7103	2.46
2SE 007 547-011	E6 452	2.35	2ST 001 673-011	K 23256/1	2.63	2VA 998 232-251	E9 5447	2.50
2SE 007 547-011	E6 453	2.35	2ST 003 014-141	E1 31453	2.118	2VA 998 232-291	E9 5447	2.50
2SE 007 547-017	E6 450	2.35	2ST 003 014-141	E1 53210	2.118	2VA 998 232-547	E4 10148	2.47
2SE 007 547-017	E6 451	2.35	2ST 003 018-061	K 23260/1	2.73	2VA 998 233-271	E4 10162	2.51
2SE 007 547-017	E6 452	2.35	2SW 003 014-131	E1 31452	2.118	2VA 998 233-357	E4 10162	2.51
2SE 007 547-017	E6 453	2.35	2SW 003 014-131	E1 53211	2.118	2VA 998 233-367	E4 10162	2.51
2SE 007 547-021	E6 450	2.35	2SW 003 185-041	E1 53256	2.73	2VA 998 531-031	E12 3024	2.52
2SE 007 547-021	E6 451	2.35	2SW 003 185-047	E1 53256	2.73	2VA 998 531-031	E12 6081	2.52
2SE 007 547-021	E6 452	2.35	2SW 357 029-021	E4 17064	2.349	2VA 998 531-031	E12 7111	2.52
2SE 007 547-021	E6 453	2.35	2SW 357 029-121	E4 170643	2.349	2VB 004 887-011	E1 53384	2.19, 2.288
2SE 007 547-027	E6 450	2.35	2SW 964 169-081	E17 9803	2.100	2VB 006 040-051	E13 9385	2.32
2SE 007 547-027	E6 451	2.35	2SW 964 169-087	E17 9803	2.100	2VB 006 040-051	E13 9531	2.32
2SE 007 547-027	E6 452	2.35	2SY 003 014-121	E1 31452	2.118	2VB 007 547-171	E6 3018	2.35
2SE 007 547-027	E6 453	2.35	2SY 003 014-121	E1 53211	2.118	2VB 007 547-171	E6 450	2.35
2SE 007 547-041	E6 450	2.35	2TA 344 169-077	E17 9805	2.99	2VB 007 547-171	E6 451	2.35
2SE 007 547-041	E6 451	2.35	2TA 344 169-087	E17 9805	2.99	2VB 007 547-171	E6 452	2.35
2SE 007 547-041	E6 452	2.35	2TA 964 169-061	E17 9805	2.99	2VB 007 547-171	E6 453	2.35
2SE 357 032-011	E9 1761	2.347	2TA 964 169-067	E17 9805	2.99	2VB 341 032-111	E17 0005	2.46
2SE 357 032-021	E9 1761	2.347	2TA 964 169-767	E17 9805	2.99	2VB 341 032-111	E17 418	2.46
2SE 996 030-011	E12 4054	2.54	2TA 964 169-797	E17 9805	2.99	2VB 341 032-117	E17 0005	2.46
2SE 996 030-011	E12 7133	2.54	2TF 001 259-791	K 31420	2.113	2VB 341 032-117	E17 418	2.46
2SE 997 006-011	E12 6040	2.70	2TJ 001 633-211	E1 11553	2.168	2VB 341 032-121	E17 0005	2.46
2SE 997 006-011	E12 7058	2.70	2TJ 001 633-211	E1 11554	2.168	2VB 341 032-121	E17 418	2.46
2SE 997 008-001	E8 71-26	2.55	2TJ 001 633-211	E1 11786	2.168	2VB 341 032-127	E17 0005	2.46
2SE 997 008-001	E8 71-27	2.55	2TJ 001 633-211	E1 31416	2.168	2VB 341 032-127	E17 418	2.46
2SE 997 008-001	E8 71-28	2.55	2TM 003 057-031	E1 11583	2.116	2VB 341 032-141	E17 0005	2.46
2SE 997 088-001	E12 16066	2.24	2TM 003 057-031	E1 31315	2.116	2VB 341 032-141	E17 418	2.46
2SE 997 088-001	E12 27092	2.24	2TM 003 748-011	E1 31410	2.142, 2.317	2VB 341 032-547	E17 0005	2.46
2SE 997 088-001	E12 4035	2.24	2TM 004 361-021	E4 23152	2.144	2VB 341 032-547	E17 418	2.46
2SE 997 111-011	E12 4038	2.53	2TM 004 361-021	E4 466	2.144	2VB 343 640-011	E17 0303	2.31
2SE 997 111-011	E12 6072	2.53	2TM 004 361-021	E4 467	2.144	2VB 343 640-127	E17 0303	2.30
2SE 997 111-011	E12 7098	2.53	2TM 006 717-047	E17 378	2.138	2VB 343 640-297	E17 0303	2.30
2SE 997 111-021	E12 4038	2.53	2TM 006 717-047	E17 787	2.138	2VB 357 020-001	E9 6134	2.343
2SE 997 111-021	E12 6072	2.53	2TM 008 645-351	E1 1395	2.316	2VB 357 023-011	E9 6110	2.346
2SE 997 111-021	E12 7098	2.53	2TM 008 645-351	E1 1398	2.316	2VB 357 023-011	E9 6134	2.346
2SE 998 530-061	E4 4044	2.56	2TM 008 645-651	E1 1395	2.148, 2.316	2VB 357 032-031	E9 1761	2.347
2SE 998 530-061	E4 6484	2.56	2TM 008 645-651	E1 1398	2.148, 2.316	2VB 980 720-407	E24 5860	2.58, 2.305
2SE 998 530-061	E4 7504	2.56	2TM 008 645-661	E1 1395	2.148, 2.316	2VB 980 720-407	E24 5850	2.58, 2.305
2SE 998 530-067	E4 4044	2.56	2TM 008 645-661	E1 1398	2.148, 2.316	2VB 980 720-501	E24 5860	2.58, 2.305
2SE 998 530-067	E4 6484	2.56	2TM 008 645-941	E1 1395	2.148, 2.316	2VB 980 720-507	E24 5860	2.58, 2.305
2SE 998 530-067	E4 7504	2.56	2TM 008 645-941	E1 1398	2.148, 2.316	2VB 988 232-011	E9 5447	2.47
2SK 003 567-321	E4 23215	2.22, 2.287	2TM 008 645-947	E1 1395	2.148	2VB 988 232-021	E9 5447	2.47
2SK 003 567-321	E4 377	2.22, 2.287	2TM 008 645-947	E1 1398	2.148	2VB 988 232-101	E9 5447	2.49
2SK 003 567-321	E4 3880	2.22, 2.287	2TM 008 645-951	E1 1395	2.148, 2.316	2VB 988 232-131	E9 5447	2.49
2SK 003 567-321	E4 396	2.22, 2.287	2TM 008 645-951	E1 1398	2.148, 2.316	2VB 988 232-171	E9 5447	2.49
2SK 003 567-321	E4 397	2.22, 2.287	2TM 008 645-957	E1 1395	2.148	2VB 988 232-201	E9 5447	2.49
2SK 003 567-321	E4 23215	2.22, 2.287	2TM 008 645-957	E1 1398	2.148	2VB 988 232-211	E9 5447	2.48
2SK 003 567-321	E4 377	2.22, 2.287	2TM 344 690-357	e17 30227	2.151	2VB 988 232-221	E9 5447	2.48
2SK 003 567-321	E4 3880	2.22, 2.287	2TM 345 600-307	E24 5881	2.145	2VB 988 232-231	E9 5447	2.50
2SK 003 567-321	E4 396	2.22, 2.287	2TM 345 600-311	E24 5881	2.145	2VB 988 232-241	E9 5447	2.50
2SK 003 567-321	E4 397	2.22, 2.287	2TM 345 600-317	E24 5881	2.145, 2.317	2VB 988 232-537	E4 10148	2.47
2SK 003 567-651	E4 23215	2.22, 2.287	2TM 357 008-021	E9 1553	2.351	2VD 003 567-371	E4 23215	2.21
2SK 003 567-651	E4 377	2.22, 2.287	2TM 357 009-011	E4 14801	2.352	2VD 003 567-371	E4 3134	2.21
2SK 003 567-651	E4 3880	2.22, 2.287	2TM 357 009-111	E4 14801	2.352	2VD 003 567-371	E4 377	2.21
2SK 003 567-651	E4 396	2.22, 2.287	2TM 357 010-011	E4 8115	2.352	2VD 003 567-371	E4 3880	2.21
2SK 003 567-651	E4 397	2.22, 2.287	2TM 357 010-111	E4 8115	2.352	2VD 003 567-371	E4 396	2.21
2SK 003 567-661	E4 23215	2.22, 2.287	2TM 357 011-011	E4 8639	2.357	2VD 003 567-371	E4 397	2.21
2SK 003 567-661	E4 377	2.22, 2.287	2TM 357 012-011	E9 1280	2.353	2VD 003 567-371	E4 4033	2.21
2SK 003 567-661	E4 3880	2.22, 2.287	2TM 964 295-091	E17 0302	2.153	2VD 005 300-551	E1 31432	2.18, 2.293
2SK 003 567-661	E4 396	2.22, 2.287	2TM 964 295-097	E17 0302	2.153	2VD 005 300-551	E1 63217	2.18, 2.293
2SK 003 567-661	E4 397	2.22, 2.287	2TM 964 295-101	E17 0302	2.153	2VD 005 300-581	E1 31432	2.18, 2.293
2SK 004 460-031	E17 9303	2.37	2TM 964 295-107	E17 0302	2.153	2VD 005 300-581	E1 63217	2.18, 2.293
2SK 004 460-037	E17 9303	2.37	2VA 004 887-031	E1 53384	2.19, 2.288	2VD 007 323-031	E4 279	2.08
2SK 004 460-041	E17 9303	2.37	2VA 006 040-071	E13 9385	2.32	2VD 007 323-031	E4 280	2.08
2SK 005 883-011	E4 1247	2.18	2VA 006 040-071	E13 9531	2.32	2VD 007 323-031	E4 4039	2.08
2SK 005 883-011	E4 1305	2.18	2VA 006 040-077	E13 9385	2.32	2VD 007 323-041	E4 279	2.08
2SK 005 883-011	E4 23167	2.18	2VA 006 040-077	E13 9531	2.32	2VD 007 323-041	E4 280	2.08
2SK 005 883-011	E4 3848	2.18	2VA 006 040-291	E13 9385	2.33	2VD 007 323-041	E4 4039	2.08
2SK 005 883-011	E4 4026	2.18	2VA 006 040-291	E13 9531	2.33	2VD 007 323-131	E4 279	2.08
2SK 005 883-021	E4 1247	2.18	2VA 006 356-101	E1 02350	2.52	2VD 007 323-131	E4 280	2.08
2SK 005 883-021	E4 1305	2.18	2VA 007 356-101	E1 63255	2.52	2VD 007 323-131	E4 4039	2.08
2SK 005 883-021	E4 23167	2.18	2VA 007 502-011	E17 9604	2.42	2VD 007 323-141	E4 279	2.08
2SK 005 883-021	E4 3848	2.18	2VA 007 502-017	E17 9604	2.42	2VD 007 323-141	E4 280	2.08
2SK 005 883-021	E4 4026	2.18	2VA 007 502-021	E17 9604	2.42	2VD 007 323-141	E4 4039	2.08
2SK 340 101-001	E1 71	2.285	2VA 007 502-061	E17 9604	2.42	2VD 007 500-091	E1 31432	2.17, 2.286
2SK 340 101-011	E1 71	2.285	2VA 007 502-111	E17 9604	2.42	2VD 007 500-091	E1 63217	2.17, 2.286
2SK 340 101-021	E1 71	2.285	2VA 007 502-117	E17 9604	2.42	2VD 007 500-111	E1 31432	2.17, 2.286
2SK 340 101-031	E1 71	2.285	2VA 011 900-001	E1 6919	2.57	2VD 007 500-111	E1 63217	2.17, 2.286
2SK 343 440-027	E17 0501	2.41	2VA 011 900-011	E1 6919	2.57	2VD 007 500-201	E1 31432	2.17, 2.286
2SK 343 440-037	E17 0501	2.41	2VA 011 900-021	E1 6919	2.57	2VD 007 500-201	E1 63217	2.17, 2.286
2SK 980 602-501	E24 5894	2.64, 2.302	2VA 011 900-031	E1 6919	2.57	2VD 007 500-221	E1 31432	2.17, 2.286
2SK 980 603-503	E24 0958	2.64, 2.302	2VA 012 497-001	E24 25887	2.59	2VD 007 500-221	E1 63217	2.17, 2.286
2SK 980 613-501	E24 5894	2.64, 2.302	2VA 012 497-011	E24 25887	2.59	2VD 007 500-411	E1 31432	2.17, 2.286
2SK 980 615-001	E24 0958	2.64, 2.302	2VA 012 497-051	E24 25887	2.59	2VD 007 500-411	E1 63217	2.17, 2.286
2SL 003 567-311	E4 23215	2.22, 2.287	2VA 012 497-061	E24 25887	2.59	2VD 007 547-181	E6 1375	2.35
2SL 003 567-311	E4 3134	2.22, 2.287	2VA 012 497-101	E24 25887	2.59	2VD 007 547-181	E6 3018	2.35
2SL 003 567-311	E4 377	2.22, 2.287	2VA 012 497-111	E24 25887	2.59	2VD 007 547-181	E6 450	2.35
2SL 003 567-311	E4 3880	2.22, 2.287	2VA 012 497-151	E24 25887	2.59	2VD 007 547-181	E6 451	2.35
2SL 003 567-311	E4 397	2.22, 2.287	2VA 012 497-161	E24 25887	2.59	2VD 007 547-181	E6 452	2.35
2SL 003 567-311	E4 421	2.22, 2.287	2VA 341 419-011	E4 9836	2.43	2VD 008 204-051	E4 3178	2.10, 2.290
2SL 003 567-691	E4 23215	2.22	2VA 341 419-021	E4 9836	2.43	2VD 008 204-051	E4 4060	2.10, 2.290
2SL 003 567-691	E4 377	2.22	2VA 341 419-061	E4 9836	2.43	2VD 008 204-051	E4 9808	2.10, 2.290



Type approval numbers

Part no.	Type approval no.	Page	Part no.	Type approval no.	Page	Part no.	Type approval no.	Page
2VD 008 204-141	E4 9810	2.10	2VP 007 500-421	E1 63217	2.17, 2.286	2VP 340 888-011	E4 10219	2.12, 2.292
2VD 008 204-171	E4 3178	2.10, 2.290	2VP 007 502-031	E17 9604	2.42	2VP 340 888-017	E4 10218	2.12
2VD 008 204-171	E4 4060	2.10, 2.290	2VP 007 502-041	E17 9604	2.42	2VP 340 888-017	E4 10219	2.12
2VD 008 204-171	E4 9808	2.10, 2.290	2VP 007 502-121	E17 9604	2.42	2VP 340 930-001	E4 10218	2.279
2VD 008 204-171	E4 9810	2.10, 2.290	2VP 007 502-127	E17 9604	2.42	2VP 340 930-011	E4 10218	2.279
2VD 008 204-191	E4 3178	2.10	2VP 007 907-031	E17 9701	2.19	2VP 340 930-021	E4 10218	2.279
2VD 008 204-191	E4 4060	2.10	2VP 007 907-037	E17 9701	2.19	2VP 340 930-021	E4 10219	2.279
2VD 008 204-191	E4 9808	2.10	2VP 007 907-041	E17 9701	2.19	2VP 340 930-031	E4 10218	2.279
2VD 008 204-191	E4 9810	2.10	2VP 007 907-047	E17 9701	2.19	2VP 340 930-031	E4 10219	2.279
2VD 008 204-211	E4 3178	2.09, 2.289	2VP 008 204-041	E4 3178	2.10, 2.290	2VP 340 930-101	E4 10211	2.280
2VD 008 204-211	E4 4060	2.09, 2.289	2VP 008 204-041	E4 4060	2.10, 2.290	2VP 340 930-101	E4 10218	2.280
2VD 008 204-211	E4 9808	2.09, 2.289	2VP 008 204-041	E4 9808	2.10, 2.290	2VP 340 930-111	E4 10211	2.280
2VD 008 204-211	E4 9810	2.09, 2.289	2VP 008 204-041	E4 9810	2.10, 2.290	2VP 340 930-111	E4 10218	2.280
2VD 008 204-231	E4 3178	2.09, 2.289	2VP 008 204-061	E4 3178	2.10, 2.290	2VP 340 931-001	E4 10218	2.278
2VD 008 204-231	E4 4060	2.09, 2.289	2VP 008 204-061	E4 4060	2.10, 2.290	2VP 340 931-011	E4 10218	2.278
2VD 008 204-231	E4 9808	2.09, 2.289	2VP 008 204-061	E4 9808	2.10, 2.290	2VP 340 931-101	E4 10211	2.280
2VD 008 204-231	E4 9810	2.09, 2.289	2VP 008 204-061	E4 9810	2.10, 2.290	2VP 340 931-101	E4 10218	2.280
2VD 008 204-251	E4 3178	2.09, 2.289	2VP 008 204-081	E4 3179	2.11, 2.291	2VP 340 931-111	E4 10211	2.280
2VD 008 204-251	E4 4060	2.09, 2.289	2VP 008 204-081	E4 4060	2.11, 2.291	2VP 340 931-111	E4 10218	2.280
2VD 008 204-251	E4 9808	2.09, 2.289	2VP 008 204-081	E4 9809	2.11, 2.291	2VP 340 932-001	E4 10218	2.281
2VD 008 204-251	E4 9810	2.09, 2.289	2VP 008 204-081	E4 9810	2.11, 2.291	2VP 340 932-001	E4 11386	2.281
2VD 008 205-011	E4 3178	2.12, 2.292	2VP 008 204-101	E4 3179	2.11, 2.291	2VP 340 932-011	E4 10218	2.281
2VD 008 205-011	E4 4060	2.12, 2.292	2VP 008 204-101	E4 4060	2.11, 2.291	2VP 340 932-011	E4 11386	2.281
2VD 008 205-011	E4 9808	2.12, 2.292	2VP 008 204-101	E4 9809	2.11, 2.291	2VP 340 934-101	E4 10218	2.281
2VD 008 205-011	E4 9811	2.12, 2.292	2VP 008 204-101	E4 9810	2.11, 2.291	2VP 340 934-101	E4 11386	2.281
2VD 008 205-021	E4 3178	2.12, 2.292	2VP 008 204-121	E4 3178	2.10, 2.290	2VP 340 934-101	E4 11392	2.281
2VD 008 205-021	E4 4060	2.12, 2.292	2VP 008 204-121	E4 4060	2.10, 2.290	2VP 340 934-111	E4 10218	2.281
2VD 008 205-021	E4 9808	2.12, 2.292	2VP 008 204-121	E4 9808	2.10, 2.290	2VP 340 934-111	E4 11386	2.281
2VD 008 205-021	E4 9811	2.12, 2.292	2VP 008 204-121	E4 9810	2.10, 2.290	2VP 340 934-111	E4 11392	2.281
2VD 008 205-041	E4 3178	2.12, 2.292	2VP 008 204-161	E4 3178	2.10, 2.290	2VP 340 940-101	E4 11392	2.283
2VD 008 205-041	E4 4060	2.12, 2.292	2VP 008 204-161	E4 9808	2.10, 2.290	2VP 340 940-101	E4 11779	2.283
2VD 008 205-041	E4 9808	2.12, 2.292	2VP 008 204-161	E4 9810	2.10, 2.290	2VP 340 940-111	E4 11392	2.283
2VD 008 205-041	E4 9811	2.12, 2.292	2VP 008 204-181	E4 3178	2.10	2VP 340 940-111	E4 11779	2.283
2VD 008 205-051	E4 3178	2.12, 2.292	2VP 008 204-181	E4 9808	2.10	2VP 340 942-001	E4 11779	2.282
2VD 008 205-051	E4 4060	2.12, 2.292	2VP 008 204-181	E4 9810	2.10	2VP 340 942-011	E4 11779	2.282
2VD 008 205-051	E4 9808	2.12, 2.292	2VP 008 204-201	E4 3178	2.09, 2.289	2VP 340 942-101	E4 11779	2.283
2VD 008 205-051	E4 9811	2.12, 2.292	2VP 008 204-201	E4 4060	2.09, 2.289	2VP 340 950-011	E1 2376	2.284
2VD 008 789-011	E2 7078	2.20	2VP 008 204-201	E4 9808	2.09, 2.289	2VP 340 950-021	E1 2376	2.284
2VD 008 789-011	E9 5167	2.20	2VP 008 204-201	E4 9810	2.09, 2.289	2VP 340 950-031	E1 2376	2.284
2VD 011 511-031	E1 3443	2.13, 2.294	2VP 008 204-221	E4 3178	2.09, 2.289	2VP 340 950-041	E1 2376	2.284
2VD 011 511-231	E1 3443	2.13, 2.294	2VP 008 204-221	E4 4060	2.09, 2.289	2VP 340 950-051	E1 2376	2.284
2VD 012 381-011	E24 5884	2.14, 2.295	2VP 008 204-221	E4 9808	2.09, 2.289	2VP 340 960-011	E24 5855	2.271
2VD 012 381-031	E24 5884	2.14, 2.295	2VP 008 204-221	E4 9810	2.09, 2.289	2VP 340 960-011	E24 5855	2.271
2VD 012 381-211	E24 5884	2.16, 2.297	2VP 008 204-241	E4 3178	2.09, 2.289	2VP 340 960-021	E24 5855	2.271
2VD 012 381-251	E24 5884	2.16, 2.297	2VP 008 204-241	E4 4060	2.09, 2.289	2VP 340 960-021	E24 5855	2.271
2VD 012 381-261	E24 5884	2.297	2VP 008 204-241	E4 9808	2.09, 2.289	2VP 340 960-111	E24 5855	2.271
2VD 012 381-281	E24 5884	2.297	2VP 008 204-241	E4 9810	2.09, 2.289	2VP 340 960-111	E24 5855	2.271
2VD 012 381-311	E24 5884	2.15, 2.296	2VP 008 205-031	E4 3178	2.12, 2.292	2VP 340 960-111	E24 5855	2.271
2VD 012 381-351	E24 5884	2.15, 2.296	2VP 008 205-031	E4 4060	2.12, 2.292	2VP 340 960-121	E24 5855	2.271
2VP 003 567-111	E4 23215	2.21, 2.287	2VP 008 205-031	E4 9808	2.12, 2.292	2VP 340 960-121	E24 5855	2.271
2VP 003 567-111	E4 3134	2.21, 2.287	2VP 008 205-031	E4 9811	2.12, 2.292	2VP 340 960-271	E24 5855	2.271
2VP 003 567-111	E4 377	2.21, 2.287	2VP 008 789-021	E2 7078	2.20	2VP 340 960-271	E24 5855	2.271
2VP 003 567-111	E4 3880	2.21, 2.287	2VP 008 789-021	E9 5167	2.20	2VP 340 960-281	E24 5855	2.271
2VP 003 567-111	E4 397	2.21, 2.287	2VP 008 789-041	E2 7078	2.20	2VP 340 960-281	E24 5855	2.271
2VP 003 567-111	E4 421	2.21, 2.287	2VP 008 789-041	E9 5167	2.20	2VP 340 961-011	E24 5855	2.272
2VP 003 567-121	E4 23215	2.21, 2.287	2VP 008 789-051	E2 7078	2.20	2VP 340 961-011	E24 5855	2.272
2VP 003 567-121	E4 3134	2.21, 2.287	2VP 008 789-051	E9 5167	2.20	2VP 340 961-021	E24 5855	2.272
2VP 003 567-121	E4 377	2.21, 2.287	2VP 008 789-071	E2 7078	2.20	2VP 340 961-021	E24 5855	2.272
2VP 003 567-121	E4 3880	2.21, 2.287	2VP 008 789-071	E9 5167	2.20	2VP 340 961-031	E24 5855	2.272
2VP 003 567-121	E4 397	2.21, 2.287	2VP 011 511-041	E1 3443	2.13, 2.294	2VP 340 961-031	E24 5855	2.272
2VP 003 567-121	E4 421	2.21, 2.287	2VP 011 511-081	E1 3443	2.13, 2.294	2VP 340 961-041	E24 5855	2.272
2VP 003 567-127	E4 23215	2.21	2VP 011 511-241	E1 3443	2.13, 2.294	2VP 340 961-041	E24 5855	2.272
2VP 003 567-127	E4 3134	2.21	2VP 012 381-021	E24 5884	2.14, 2.295	2VP 340 961-111	E24 5855	2.272-2.273
2VP 003 567-127	E4 377	2.21	2VP 012 381-041	E24 5884	2.14, 2.295	2VP 340 961-111	E24 5855	2.272-2.273
2VP 003 567-127	E4 3880	2.21	2VP 012 381-041	E24 5884	2.14, 2.295	2VP 340 961-121	E24 5855	2.272-2.273
2VP 003 567-127	E4 397	2.21	2VP 012 381-051	E24 5884	2.14, 2.295	2VP 340 961-121	E24 5855	2.272-2.273
2VP 003 567-127	E4 421	2.21	2VP 012 381-061	E24 5884	2.14, 2.295	2VP 340 961-131	E24 5855	2.274
2VP 004 887-021	E1 53384	2.19, 2.288	2VP 012 381-081	E24 5884	2.14, 2.295	2VP 340 961-131	E24 5855	2.274
2VP 006 040-111	E13 9385	2.32	2VP 012 381-221	E24 5884	2.16, 2.297	2VP 340 961-141	E24 5855	2.274
2VP 006 040-111	E13 9531	2.32	2VP 012 381-241	E24 5884	2.16, 2.297	2VP 340 961-141	E24 5855	2.274
2VP 006 040-117	E13 9385	2.32	2VP 012 381-321	E24 5884	2.15, 2.296	2VP 340 961-211	E24 5855	2.274
2VP 006 040-117	E13 9531	2.32	2VP 012 381-341	E24 5884	2.15, 2.296	2VP 340 961-211	E24 5855	2.274
2VP 006 040-121	E13 9385	2.32	2VP 012 381-361	E24 5884	2.15, 2.296	2VP 340 961-221	E24 5855	2.274
2VP 006 040-121	E13 9531	2.32	2VP 012 381-381	E24 5884	2.15, 2.296	2VP 340 961-221	E24 5855	2.274
2VP 006 040-127	E13 9385	2.32	2VP 340 400-121	E1 864	2.298	2VP 340 961-411	E24 5855	2.275
2VP 006 040-127	E13 9531	2.32	2VP 340 400-131	E1 864	2.298	2VP 340 961-411	E24 5855	2.275
2VP 006 040-301	E13 9385	2.33	2VP 340 400-141	E1 864	2.298	2VP 340 961-421	E24 5855	2.275
2VP 006 040-301	E13 9531	2.33	2VP 340 400-147	E1 864	2.298	2VP 340 961-431	E24 5855	2.275
2VP 006 040-307	E13 9385	2.33	2VP 340 400-151	E1 864	2.298	2VP 340 961-431	E24 5855	2.275
2VP 006 040-307	E13 9531	2.33	2VP 340 400-157	E1 864	2.298	2VP 340 961-441	E24 5855	2.275
2VP 006 040-351	E13 9385	2.33	2VP 340 400-451	E1 864	2.298	2VP 340 961-441	E24 5855	2.275
2VP 006 040-351	E13 9531	2.33	2VP 340 400-471	E1 864	2.298	2VP 341 032-537	E17 0005	2.46
2VP 006 040-357	E13 9385	2.33	2VP 340 450-021	E1 1072	2.277	2VP 341 032-537	E17 418	2.46
2VP 006 040-357	E13 9531	2.33	2VP 340 450-031	e4 280	2.277	2VP 341 419-047	E4 9836	2.43
2VP 006 040-397	E13 9							

Type approval numbers



Part no.	Type approval no.	Page	Part no.	Type approval no.	Page	Part no.	Type approval no.	Page
2VP 345 900-021	E24 5879	2,27, 2,301	2XD 009 052-021	E1 2141	3,15	2XS 008 479-097	E1 1201	2,191
2VP 345 900-021	E24 5880	2,27, 2,301	2XD 009 052-021	e1 3486	3,15	2XS 008 479-107	E1 1201	2,191
2VP 345 900-091	E17 0071	2,27, 2,301	2XD 009 052-031	E1 2141	3,15	2XS 008 479-117	E1 1201	2,191
2VP 345 900-091	E24 5879	2,27, 2,301	2XD 009 052-031	e1 3486	3,15	2XS 009 226-107	E11 3017	2,158
2VP 345 900-091	E24 5880	2,27, 2,301	2XD 009 053-001	E1 1765	3,14	2XS 011 744-011	E4 11392	2,271-2,272, 2,274-2,275, 2,318
2VP 345 900-101	E17 0071	2,27, 2,301	2XD 009 053-001	e1 3486	3,14			2,271-2,272, 2,274-2,275, 2,318
2VP 345 900-101	E24 5879	2,27, 2,301	2XD 009 053-021	E1 2141	3,14	2XS 011 744-021	E4 11392	2,271-2,272, 2,274-2,275, 2,318
2VP 345 900-101	E24 5880	2,27, 2,301	2XD 009 053-021	e1 3486	3,14			2,271-2,272, 2,274-2,275, 2,318
2VP 345 900-131	E17 0071	2,27, 2,301	2XD 009 054-001	E1 1765	3,15	2XS 011 744-031	E4 11392	2,318
2VP 345 900-131	E24 5879	2,27, 2,301	2XD 009 054-001	e1 3486	3,15	2XS 011 744-041	E4 11392	2,318
2VP 345 900-131	E24 5880	2,27, 2,301	2XD 009 475-001	E1 2113	3,34	2XS 011 744-051	E4 11392	2,318
2VP 345 900-141	E17 0071	2,27, 2,301	2XD 009 475-001	e1 3686	3,34	2XS 011 744-061	E4 11392	2,318
2VP 345 900-141	E24 5879	2,27, 2,301	2XD 009 475-011	E1 2113	3,34	2XS 011 744-071	E4 11392	2,318
2VP 345 900-141	E24 5880	2,27, 2,301	2XD 009 475-011	e1 3686	3,34	2XS 011 744-081	E4 11392	2,318
2VP 345 900-201	E17 0071	2,25, 2,299	2XD 009 475-021	E1 2113	3,34	2XS 011 744-101	E4 11392	2,318
2VP 345 900-201	E24 5879	2,25, 2,299	2XD 009 475-021	e1 3686	3,34	2XS 011 744-111	E4 11392	2,318
2VP 345 900-201	E24 5880	2,25, 2,299	2XD 009 475-031	E1 2113	3,34	2XS 011 744-161	E4 11392	2,281, 2,283, 2,318
2VP 345 900-211	E17 0071	2,25, 2,299	2XD 009 475-031	e1 3686	3,34	2XS 011 744-171	E4 11392	2,281, 2,283, 2,318
2VP 345 900-211	E24 5879	2,25, 2,299	2XD 010 311-001	E1 2738	3,21	2XS 011 768-001	E4 11392	2,319
2VP 345 900-211	E24 5880	2,25, 2,299	2XD 010 311-001	e1 35517	3,21	2XS 011 768-011	E4 11392	2,319
2VP 345 900-221	E17 0071	2,25, 2,299	2XD 010 311-011	E1 2738	3,21	2XS 011 768-021	E4 11392	2,319
2VP 345 900-221	E24 5879	2,25, 2,299	2XD 010 311-011	e1 35517	3,21	2XS 011 768-031	E4 11392	2,319
2VP 345 900-221	E24 5880	2,25, 2,299	2XD 010 311-021	E1 2738	3,21	2XS 011 768-061	E4 11392	2,319
2VP 345 900-231	E17 0071	2,25, 2,299	2XD 010 311-021	e1 35517	3,21	2XS 011 768-071	E4 11392	2,319
2VP 345 900-231	E24 5879	2,25, 2,299	2XD 010 312-801	E1 2796	3,30	2XS 011 768-087	E4 11392	2,319
2VP 345 900-231	E24 5880	2,25, 2,299	2XD 010 312-811	E1 2796	3,30	2XS 011 769-011	E4 11392	2,320
2VP 345 900-241	E17 0071	2,26, 2,300	2XD 011 557-001	E1 3468	3,22	2XS 011 769-021	E4 11392	2,320
2VP 345 900-241	E24 5879	2,26, 2,300	2XD 011 557-011	E1 3468	3,22	2XS 011 769-051	E4 11392	2,320
2VP 345 900-241	E24 5880	2,26, 2,300	2XD 011 557-021	E1 3468	3,22	2XS 011 769-061	E4 11392	2,320
2VP 345 900-251	E17 0071	2,26, 2,300	2XD 011 557-101	E1 3468	3,22	2XS 011 769-091	E4 11392	2,320
2VP 345 900-251	E24 5879	2,26, 2,300	2XD 011 557-111	E1 3468	3,22	2XS 011 769-101	E4 11392	2,320
2VP 345 900-251	E24 5880	2,26, 2,300	2XD 011 557-121	E1 3468	3,22	2XS 205 020-001	E11 3011	2,190
2VP 345 900-261	E17 0071	2,26, 2,300	2XD 011 557-501	E1 3468	3,22	2XS 205 020-007	E11 3011	2,190
2VP 345 900-261	E24 5879	2,26, 2,300	2XD 012 160-801	E6 0471	3,31	2XS 205 020-011	E11 3011	2,190
2VP 345 900-261	E24 5880	2,26, 2,300	2XD 012 160-811	E6 0471	3,31	2XS 205 020-017	E11 3011	2,190
2VP 345 900-271	E17 0071	2,26, 2,300	2XD 012 160-821	E6 0471	3,31	2XS 205 020-021	E11 3011	2,190
2VP 345 900-271	E24 5879	2,26, 2,300	2XD 012 160-831	E6 0471	3,31	2XS 205 020-027	E11 3011	2,190
2VP 345 900-271	E24 5880	2,26, 2,300	2XD 012 160-841	E6 0471	3,31	2XS 205 020-031	E11 3011	2,190
2VP 345 900-331	E17 0071	2,27, 2,301	2XD 012 160-851	E6 0471	3,31	2XS 205 020-037	E11 3011	2,190
2VP 345 900-331	E24 5879	2,27, 2,301	2XD 012 160-861	E6 0471	3,31	2XS 205 020-041	E11 3011	2,190
2VP 345 900-331	E24 5880	2,27, 2,301	2XD 012 160-871	E6 0471	3,31	2XS 205 020-047	E11 3011	2,190
2VP 345 900-341	E17 0071	2,27, 2,301	2XD 012 160-881	E6 0471	3,31	2XS 205 020-051	E11 3011	2,190
2VP 345 900-341	E24 5879	2,27, 2,301	2XD 012 160-901	E6 0471	3,32	2XS 205 020-057	E11 3011	2,190
2VP 345 900-341	E24 5888	2,27, 2,301	2XD 012 160-911	E6 0471	3,32	2XS 205 020-121	E11 3011	2,190
2VP 345 900-401	E17 0071	2,25, 2,299	2XD 012 160-951	E6 0471	3,32	2XS 205 020-127	E11 3011	2,190
2VP 345 900-401	E24 5879	2,25, 2,299	2XD 012 160-961	E6 0471	3,32	2XS 205 020-131	E11 3011	2,190
2VP 345 900-401	E24 5880	2,25, 2,299	2XD 012 160-971	E6 0471	3,32	2XS 205 020-137	E11 3011	2,190
2VP 345 900-411	E17 0071	2,25, 2,299	2XD 012 160-981	E6 0471	3,32	2XS 205 020-151	E11 3011	2,190
2VP 345 900-411	E24 5879	2,25, 2,299	2XD 012 480-001	E1 3109	3,23	2XS 205 020-157	E11 3011	2,190
2VP 345 900-411	E24 5880	2,25, 2,299	2XD 012 480-001	E1 3503	3,23	2XS 205 020-171	E11 3011	2,190
2VP 345 900-421	E17 0071	2,25, 2,299	2XD 012 480-011	E1 3109	3,23	2XS 205 020-177	E11 3011	2,190
2VP 345 900-421	E24 5879	2,25, 2,299	2XD 012 480-011	E1 3503	3,23	2XS 302 240-031	E4 10211	2,322
2VP 345 900-421	E24 5880	2,25, 2,299	2XD 012 480-101	E1 3109	3,23	2XS 302 240-051	E4 10211	2,322
2VP 345 900-431	E17 0071	2,25, 2,299	2XD 012 480-101	E1 3503	3,23	2XS 302 241-071	E4 10211	2,322
2VP 345 900-431	E24 5879	2,25, 2,299	2XD 012 480-111	E1 3109	3,23	2XS 302 241-081	E4 10211	2,322
2VP 345 900-431	E24 5880	2,25, 2,299	2XD 012 480-111	E1 3503	3,23	2XS 340 447-001	E4 10211	2,321
2VP 345 900-441	E17 0071	2,26, 2,300	2XD 012 480-201	E1 3109	3,23	2XS 340 447-001	E4 11392	2,321
2VP 345 900-441	E24 5879	2,26, 2,300	2XD 012 480-201	E1 3503	3,23	2XS 340 447-021	E4 10211	2,321
2VP 345 900-441	E24 5880	2,26, 2,300	2XD 012 480-211	E1 3109	3,23	2XS 340 447-021	E4 11392	2,321
2VP 345 900-451	E17 0071	2,26, 2,300	2XD 012 480-211	E1 3503	3,23	2XS 340 448-001	E4 10211	2,320
2VP 345 900-451	E24 5879	2,26, 2,300	2XD 012 480-301	E1 3109	3,23	2XS 340 448-001	E4 11392	2,320
2VP 345 900-451	E24 5880	2,26, 2,300	2XD 012 480-301	E1 3503	3,23	2XS 340 448-011	E4 10211	2,320
2VP 345 900-461	E17 0071	2,26, 2,300	2XD 012 480-311	E1 3109	3,23	2XS 340 448-011	E4 11392	2,320
2VP 345 900-461	E24 5879	2,26, 2,300	2XD 012 480-311	E1 3503	3,23	2XS 340 827-001	E4 10211	2,321
2VP 345 900-461	E24 5880	2,26, 2,300	2XD 861 423-011	e1 1169	3,29	2XS 340 827-011	E4 10211	2,321
2VP 345 900-471	E17 0071	2,26, 2,300	2XD 861 423-011	E1 1981	3,29	2XS 340 827-121	E4 10211	2,321
2VP 345 900-471	E24 5879	2,26, 2,300	2XD 861 423-021	e1 1169	3,29	2XS 340 827-131	E4 10211	2,321
2VP 345 900-471	E24 5880	2,26, 2,300	2XD 861 423-021	E1 1981	3,29	2XS 357 003-001	E9 6754	2,362
2VP 357 016-011	E9 6823	2,341	2XL 004 762-001	E17 346	2,56	2XS 357 004-011	E9 6754	2,361
2VP 357 016-011	E9 6891	2,341	2XL 004 762-001	E17 408	2,56	2XS 357 004-021	E9 6754	2,361
2VP 357 016-021	E9 6823	2,341	2XL 004 762-001	E17 630	2,56	2XS 357 004-031	E9 6754	2,361
2VP 357 016-021	E9 6891	2,341	2XL 004 762-001	E17 763	2,56	2XS 357 005-011	E9 6754	2,360
2VP 357 016-111	E9 6823	2,341	2XS 003 168-071	K 4106	2,192	2XS 357 005-021	E9 6754	2,360
2VP 357 016-111	E9 6891	2,341	2XS 003 168-081	K 4106	2,192	2XS 357 005-031	E9 6754	2,360
2VP 357 016-121	E9 6823	2,341	2XS 003 738-037	E1 21670	2,187	2XS 357 005-041	E9 6754	2,360
2VP 357 016-121	E9 6891	2,341	2XS 005 020-001	E1 31407	2,189, 2,324	2XS 357 006-011	E9 6753	2,359
2VP 357 017-011	E9 6719	2,341	2XS 005 020-002	E1 31407	2,189	2XS 357 006-021	E9 6753	2,359
2VP 357 017-021	E9 6719	2,341	2XS 005 020-003	E1 31407	2,189	2XS 357 007-011	E9 6753	2,359
2VP 357 018-001	E9 11422	2,342	2XS 005 020-011	E1 31407	2,189, 2,324	2XS 357 007-021	E9 6753	2,359
2VP 357 019-001	E9 1948	2,342	2XS 005 020-017	E1 31407	2,189	2XS 950 071-031	E13 9401	2,187, 2,323
2VP 357 019-011	E9 1948	2,342	2XS 005 020-021	E1 31407	2,189, 2,324	2XS 955 031-001	E13 9401	2,187, 2,323
2VP 357 021-011	E9 6958	2,344	2XS 005 020-041	E1 31407	2,189, 2,324	2XS 955 031-017	E13 9401	2,187, 2,323
2VP 357 021-031	E9 6881	2,344	2XS 005 020-047	E1 31407	2,189	2XS 955 232-001	E13 9401	2,187, 2,323
2VP 357 021-041	E9 6881	2,344	2XS 005 020-057	E1 31407	2,189	2XS 955 232-017	E13 9401	2,187
2VP 998 232-261	E9 5447	2,50	2XS 005 020-067	E1 31407	2,189	2XS 955 260-001	E13 9428	2,188



Type approval numbers

Part no.	Type approval no.	Page	Part no.	Type approval no.	Page	Part no.	Type approval no.	Page
2XT 980 855-411	E4 2899	2.157	2ZR 996 376-091	E1 36917	2.197	9EL 110 536-001	E1 32619	2.119
2XT 980 855-417	E4 2878	2.157	2ZR 996 506-501	E4 23006	2.197, 2.329	9EL 110 536-011	E1 32661	2.119
2XT 980 855-417	E4 2899	2.157	2ZR 997 506-391	E12 23005	2.197	9EL 110 540-001	E1 31418	2.118
2XW 002 897-041	K 13931	2.252	2ZR 997 506-691	E12 23007	2.197, 2.329	9EL 110 542-001	E1 11793	2.119
2XW 002 897-051	K 13931	2.252	5DS 009 552-001	e1 4906	2.07, 2.330	9EL 110 544-001	E1 8703	2.119
2XW 003 146-001	K 13932	2.253	5DS 010 668-701	E24 5852	2.172-2.173	9EL 110 736-001	E1 32617	2.211
2XW 007 146-001	K 13949	2.252, 2.329	5DS 010 668-711	E24 5852	2.172-2.173	9EL 110 737-001	E1 32617	2.211
2XW 007 146-011	K 13950	2.253, 2.330	5DS 357 030-001	E9 1529	2.340, 2.342-2.346, 2.348-2.349, 2.354-2.356	9EL 111 647-001	E1 31482	2.28
2ZR 001 193-011	E1 8709	2.201				9EL 111 647-001	E1 43222	2.28
2ZR 001 240-351	E4 2336	2.104				9EL 111 647-001	E1 53335	2.28
2ZR 001 240-377	E4 2336	2.104	8GH 007 643-121	E13 2J6	4.12	9EL 112 741-001	E1 116	2.67
2ZR 001 421-101	E1 8750	2.115	8GH 008 358-241	E1 29K	4.07	9EL 112 741-001	E1 53345	2.67
2ZR 001 423-001	E1 8704	2.89, 2.307	8GP 002 067-241	E1 2LR	4.11, 4.13	9EL 112 743-001	E1 116	2.67
2ZR 002 694-001	E1 8708	2.201	8RA 002 014-231	E24 0030	2.255	9EL 112 743-001	E1 53345	2.67
2ZR 002 985-081	E1 8712	2.193	8RA 002 014-232	E24 0030	2.255	9EL 112 744-001	E1 43388	2.67
2ZR 002 985-261	E1 8712	2.193	8RA 002 014-241	E24 0030	2.255	9EL 113 324-001	E12 7146	2.62, 2.308
2ZR 003 014-091	E1 8703	2.119	8RA 002 014-242	E24 0030	2.255	9EL 113 639-021	E1 32670	1.79
2ZR 003 030-171	E1 8726	2.193	8RA 002 014-251	E24 0030	2.255	9EL 113 928-001	E1 8708	2.201
2ZR 003 236-051	E1 8728	2.126, 2.239	8RA 002 014-252	E24 0030	2.255	9EL 114 401-001	E4 2	2.144
2ZR 003 236-057	E1 8728	2.126	8RA 002 014-257	E24 0030	2.255	9EL 114 401-001	E4 23152	2.144
2ZR 003 236-311	E1 8728	2.127	8RA 002 014-327	E24 0030	2.255	9EL 114 401-001	E4 3	2.144
2ZR 003 315-041	E1 8732	2.194	8RA 002 014-872	E24 0030	2.255	9EL 114 401-031	E4 23152	2.144
2ZR 003 734-041	E1 8731	2.135	8RA 002 015-031	E1 31291	2.256	9EL 114 401-031	E4 468	2.144
2ZR 004 432-001	E1 8728	2.130	8RA 002 016-101	E1 31290	2.256	9EL 114 401-031	E4 469	2.144
2ZR 004 542-001	E1 8743	2.200	8RA 002 016-111	E1 31290	2.256	9EL 114 401-041	E4 23152	2.144
2ZR 005 200-301	E1 8772	2.128	8RA 002 016-121	E17 339	2.256	9EL 114 401-041	E4 466	2.144
2ZR 005 603-061	E1 8770	2.133	8RA 002 020-001	E17 346	2.56, 2.259, 2.328	9EL 114 401-041	E4 467	2.144
2ZR 005 603-067	E1 8770	2.133	8RA 002 020-002	E17 346	2.259	9EL 115 003-001	E1 31452	2.118
2ZR 005 700-191	E1 2185	2.200	8RA 002 020-031	E17 346	2.259	9EL 115 003-001	E1 53211	2.118
2ZR 005 860-151	E1 2186	2.200	8RA 002 020-051	E17 346	2.259	9EL 115 003-011	E1 31452	2.118
2ZR 006 609-081	E17 2309	2.195	8RA 002 023-001	E17 02379	2.258	9EL 115 003-011	E1 53211	2.118
2ZR 006 609-087	E17 2309	2.195	8RA 002 023-011	E17 02379	2.258	9EL 115 003-021	E1 31453	2.118
2ZR 006 609-171	E17 2309	2.195	8RA 002 023-021	E17 02379	2.258	9EL 115 003-021	E1 53210	2.118
2ZR 008 221-051	E1 1052	2.78	8RA 003 326-001	E1 21395	2.257	9EL 115 003-035	E1 31453	2.118
2ZR 008 221-057	E1 1052	2.78	8RA 003 326-002	E1 21395	2.257	9EL 115 003-055	E1 42712	2.119
2ZR 008 221-157	E1 1052	2.78	8RA 003 326-011	E1 21395	2.18, 2.257, 2.293	9EL 115 830-001	E1 32692	2.214
2ZR 008 805-041	E4 10151	2.132	8RA 003 326-011	E1 21395	2.257	9EL 116 844-001	E1 116	2.67
2ZR 008 805-047	E4 10151	2.132	8RA 003 326-021	E1 21395	2.257	9EL 116 844-001	E1 53345	2.67
2ZR 008 805-247	E4 10151	2.132	8RA 003 326-031	E2 92031	2.257	9EL 116 907-001	E1 32719	2.208
2ZR 009 001-011	E4 23255	2.84	8RA 003 326-041	E2 92031	2.257	9EL 117 330-001	E1 21626	2.116
2ZR 009 001-017	E4 23255	2.84	8RA 003 326-047	E2 92031	2.257	9EL 117 330-011	E1 11584	2.116
2ZR 012 456-001	E24 0016	2.198	8RA 003 326-051	E2 92031	2.257	9EL 117 334-001	E1 21629	2.116
2ZR 012 456-007	E24 0016	2.198	8RA 003 326-931	E2 92031	2.257	9EL 117 334-001	E1 31315	2.116
2ZR 012 456-011	E24 0016	2.198	8RA 003 503-001	K 13487	2.259	9EL 117 334-021	E1 280	2.116
2ZR 012 456-017	E24 0016	2.198	8RA 003 660-007	E1 31242	2.258	9EL 117 334-021	E1 31315	2.116
2ZR 012 456-021	E24 0016	2.198	8RA 003 734-101	E1 31298	2.136, 2.258	9EL 118 613-001	E1 31445	2.71
2ZR 012 456-027	E24 0016	2.198	8RA 004 412-001	E17 338	2.256	9EL 118 613-001	E1 53257	2.71
2ZR 012 456-031	E24 0016	2.198	8RA 004 412-011	E17 338	2.256	9EL 118 614-011	E1 31445	2.71
2ZR 012 456-037	E24 0016	2.198	8RA 004 412-021	E17 338	2.256	9EL 118 614-011	E1 53257	2.71
2ZR 012 456-201	E24 0017	2.198	8RA 008 405-001	E1 1196	2.74	9EL 118 614-021	E1 53270	2.71
2ZR 012 456-207	E24 0017	2.198	8RA 008 405-007	E1 1196	2.74	9EL 118 633-001	E1 53256	2.73
2ZR 012 456-211	E24 0017	2.198	8RA 009 001-031	E4 3189	2.84	9EL 118 697-001	E1 130	2.68
2ZR 012 456-217	E24 0017	2.198	8RA 009 001-037	E4 3189	2.84	9EL 118 697-001	E1 53253	2.68
2ZR 012 456-221	E24 0017	2.198	8RA 009 226-117	E11 20668	2.158	9EL 118 700-001	E1 130	2.68
2ZR 012 456-227	E24 0017	2.198	8RA 009 226-127	E11 20668	2.158	9EL 118 700-001	E1 53253	2.68
2ZR 012 456-231	E24 0016	2.198	8RA 009 226-137	E11 20668	2.158	9EL 118 701-001	E1 130	2.68
2ZR 012 456-237	E24 0016	2.198	8RA 009 362-001	E4 3302	2.79-2.80	9EL 118 701-001	E1 53253	2.68
2ZR 013 236-051	E1 3663	2.122	8RA 123 251-005	E1 130	2.68	9EL 118 703-001	E1 102	2.68
2ZR 013 236-061	E1 3663	2.122	8RA 123 251-005	E1 52253	2.68	9EL 118 703-001	E1 53254	2.68
2ZR 013 236-111	E1 3663	2.124	8RA 123 251-005	E1 53253	2.68	9EL 118 705-001	E1 102	2.68
2ZR 013 236-121	E1 3663	2.124	8RA 342 014-157	E17 402	2.256	9EL 118 705-001	E1 53254	2.68
2ZR 013 236-251	E1 3663	2.122	8RA 343 160-002	E4 3190	2.155	9EL 119 397-001	E1 53259	2.73
2ZR 013 236-261	E1 3663	2.122	8RA 343 160-007	E4 3190	2.155	9EL 119 544-001	e1 18411	2.126-2.127, 2.129-2.130
2ZR 013 236-311	E1 3663	2.124	8RA 343 160-017	E4 3190	2.155			
2ZR 013 236-321	E1 3663	2.124	8RA 343 160-022	E4 3190	2.155			
2ZR 302 252-047	E4 10909	2.88	8RA 343 160-027	E4 3190	2.155			
2ZR 343 130-041	E4 23257	2.112	8RA 343 220-007	E4 3191	2.259, 2.328	9EL 119 544-001	E2 167	2.126-2.127, 2.129-2.130
2ZR 343 130-047	E4 23257	2.112	8RA 343 220-017	E4 3191	2.259, 2.328			
2ZR 343 130-387	E4 23257	2.107	8RA 344 065-007	E4 3322	2.40	9EL 119 544-021	E1 22859	2.126-2.127, 2.129
2ZR 343 130-607	E4 23257	2.112	8RA 344 610-017	E24 5857	2.196	9EL 119 544-021	E1 243	2.126-2.127, 2.129
2ZR 344 169-157	E17 2311	2.102	8RB 004 713-001	E17 353	2.257	9EL 119 544-021	E1 32764	2.126-2.127, 2.129
2ZR 344 169-167	E17 2311	2.102	8RL 002 009-021	E1 21340	2.258	9EL 119 544-031	E1 240	2.126-2.127, 2.129
2ZR 344 200-051	E4 12371	2.93, 2.315	8WS 008 549-001	E1 0130	1.54-1.55	9EL 119 544-101	E1 22859	2.129
2ZR 344 200-051	E4 12658	2.93, 2.315	8WS 008 549-501	E1 0130	1.54-1.55	9EL 119 544-101	E2 32764	2.129
2ZR 344 200-051	E4 14198	2.93, 2.315	8WT 008 549-101	E1 0130	1.55	9EL 119 544-111	E1 8728	2.126-2.127, 2.130, 2.239
2ZR 344 200-057	E4 14198	2.93	8WT 008 549-201	E1 0130	1.55			
2ZR 357 025-021	E9 11523	2.348	8WT 008 549-601	E1 0130	1.55	9EL 119 614-031	E1 213	2.55
2ZR 357 026-041	E4 23271	2.354	8WT 008 549-701	E1 0130	1.55	9EL 119 614-031	E1 43331	2.55
2ZR 357 027-041	E9 1192	2.355	9BG 130 945-001	E4 23215	2.23	9EL 119 977-001	E1 8486	2.194
2ZR 357 028-041	E9 1151	2.356	9BG 130 945-001	E4 377	2.23	9EL 120 201-001	E1 11591	2.126-2.127
2ZR 357 029-051	E4 23474	2.350	9BG 130 945-001	E4 3880	2.23	9EL 120 224-001	E1 53274	2.219
2ZR 357 029-151	E4 23474	2.350	9BG 130 945-001	E4 397	2.23	9EL 121 431-001	E1 130	2.68
2ZR 959 010-501	E4 11391	2.91, 2.310	9BG 130 945-001	E4 421	2.23	9EL 121 431-001	E1 53253	2.68
2ZR 959 010-507	E4 11391	2.91, 2.310	9BG 130 946-001	E4 23215	2.23	9EL 122 689-021	E4 23215	2.21, 2.23, 2.287
2ZR 959 820-601	E4 10208	2.103, 2.306	9BG 130 946-001	E4 377	2.23	9EL 122 689-021	E4 3134	2.21, 2.23, 2.287
2ZR 964 169-031	E17 2311	2.102	9BG 130 946-001	E4 3880	2.23	9EL 122 689-021	E4 377	2.21, 2.23, 2.287
2ZR 964 169-037	E17 2311	2.102	9BG 130 946-001	E4 397	2.23	9EL 122 689-021	E4 3880	2.21, 2.23, 2.287
2ZR 964 169-107	E17 2311	2.102	9BG 130 946-001	E4 421	2.23	9EL 122 689-021	E4 397	

Type approval numbers



Part no.	Type approval no.	Page	Part no.	Type approval no.	Page	Part no.	Type approval no.	Page
9EL 132 215-001	E1 31407	2.189, 2.324	9EL 154 637-001	E4 3169	2.164	9GP 003 995-801	E4 421	2.21-2.23, 2.36,
9EL 132 215-011	E1 31407	2.189, 2.324	9EL 340 201-001	E1 71	2.285	9XX 340 173-801	E4 11386	2.285, 2.287
9EL 132 403-001	E1 11553	2.166, 2.168	9EL 340 203-001	E1 864	2.298			2.282
9EL 132 403-001	E1 11554	2.166, 2.168	9EL 340 203-011	E1 864	2.298			
9EL 132 403-001	E1 11786	2.166, 2.168	9EL 340 208-001	E1 1072	2.276-2.277			
9EL 132 403-001	E1 31416	2.166, 2.168	9EL 343 142-001	E17 0303	2.29-2.31			
9EL 132 404-001	E1 11553	2.166, 2.168	9EL 343 143-001	E17 0303	2.29-2.31			
9EL 132 404-001	E1 11786	2.166, 2.168	9EL 343 143-011	E17 0303	2.30-2.31			
9EL 132 404-001	E1 31416	2.166, 2.168	9EL 357 012-101	E9 1280	2.353			
9EL 134 296-041	E1 280	2.17-2.18, 2.286,	9EL 357 012-111	E9 1280	2.353			
		2.293	9EL 357 012-121	E9 1280	2.353			
9EL 134 296-041	E1 31432	2.17-2.18, 2.286,	9EL 357 031-101	E9 6512	2.340			
		2.293	9EL 357 032-101	E9 1761	2.347			
9EL 134 296-041	E1 63217	2.17-2.18, 2.286,	9EL 357 032-111	E9 1761	2.347			
		2.293	9EL 357 033-111	E9 1966	2.345			
9EL 134 296-051	E1 280	2.17-2.18, 2.286,	9EL 856 415-001	E2 88072	3.26			
		2.293	9EL 856 415-001	E4 6506	3.26			
9EL 134 296-051	E1 31432	2.17-2.18, 2.286,	9EL 856 415-001	K 8649	3.26			
		2.293	9EL 856 416-001	E2 88072	3.26-3.27			
9EL 134 296-051	E1 63217	2.17-2.18, 2.286,	9EL 856 416-001	E4 6506	3.26-3.27			
		2.293	9EL 856 416-001	K 8651	3.26-3.27			
9EL 134 301-001	E1 280	2.17-2.18, 2.286,	9EL 856 416-011	E2 88072	3.27			
		2.293	9EL 856 416-011	E4 6506	3.27			
9EL 134 301-001	E1 31432	2.17-2.18, 2.286,	9EL 856 417-001	E2 88072	3.26			
		2.293	9EL 856 417-001	K 8650	3.26			
9EL 134 301-001	E1 63217	2.17-2.18, 2.286,	9EL 856 418-001	E2 88072	3.26-3.27			
		2.293	9EL 856 418-001	K 8652	3.26-3.27			
9EL 134 301-011	E1 280	2.17-2.18, 2.286,	9EL 856 418-011	E2 88072	3.27			
		2.293	9EL 856 418-011	K 8652	3.27			
9EL 134 301-011	E1 31432	2.17-2.18, 2.286,	9EL 857 801-001	E4 6504	3.26			
		2.293	9EL 857 801-001	K 8687	3.26			
9EL 134 301-011	E1 63217	2.17-2.18, 2.286,	9EL 857 803-001	E4 6504	3.26			
		2.293	9EL 857 803-001	K 8694	3.26			
9EL 134 658-001	E1 42763	2.209	9EL 859 020-001	E4 6509	3.04-3.05			
9EL 134 659-001	E1 42764	2.209	9EL 859 020-001	K 18614	3.04-3.05			
9EL 134 660-001	E1 42764	2.209	9EL 859 020-101	E4 6513	3.04-3.05			
9EL 134 739-001	E1 273	2.72	9EL 859 020-101	K 18614	3.04-3.05			
9EL 134 739-001	E1 63230	2.72	9EL 859 020-101	K 18659	3.04-3.05			
9EL 134 740-001	E1 273	2.72	9EL 859 658-001	E4 6510	3.18, 3.28			
9EL 134 740-001	E1 63230	2.72	9EL 859 658-001	K 18652	3.18, 3.28			
9EL 134 741-021	E1 63225	2.72	9EL 859 658-011	E4 6511	3.18, 3.28			
9EL 134 742-021	E1 63225	2.72	9EL 859 658-011	K 18651	3.18, 3.28			
9EL 135 060-001	E1 31433	2.135	9EL 860 627-001	E4 6514	3.07-3.08			
9EL 135 266-001	E1 31438	2.13	9EL 860 627-011	E4 6514	3.09			
9EL 135 548-001	e4 1247	2.18	9EL 862 140-001	E1 1240	3.10-3.11			
9EL 135 548-001	e4 23167	2.18	9EL 862 140-021	E1 1240	3.16-3.17			
9EL 135 548-001	e4 305	2.18	9EL 862 140-031	E1 1399	3.16-3.17			
9EL 135 548-001	E4 3848	2.18	9EL 862 141-001	E1 1241	3.10-3.12			
9EL 135 548-001	E4 4026	2.18	9EL 862 171-001	E1 1242	3.13			
9EL 136 819-011	E13 9385	2.33	9EL 862 172-001	E1 1243	3.13			
9EL 136 819-031	E13 9385	2.32	9EL 950 315-031	E13 9401	2.187, 2.323			
9EL 136 819-031	E13 9531	2.32	9EL 950 315-061	E13 9401	2.187, 2.323			
9EL 136 819-041	E13 9385	2.34	9EL 963 983-001	E17 9705	2.143			
9EL 136 825-001	E13 9385	2.32	9EL 963 984-001	E17 805	2.143			
9EL 136 825-001	E13 9531	2.32	9EL 964 289-001	E13 9428	2.188			
9EL 136 825-011	E13 9385	2.32	9EL 964 289-001	E17 801	2.188			
9EL 136 825-011	E13 9531	2.32	9EL 964 290-001	E17 801	2.188			
9EL 136 833-001	E13 9385	2.33	9EL 964 526-001	E17 808	2.100			
9EL 136 833-011	E13 9385	2.32	9EL 964 527-001	E17 648	2.100			
9EL 136 833-011	E13 9531	2.32	9EL 964 529-001	E17 2311	2.102			
9EL 137 241-001	E1 31446	2.165	9EL 964 530-001	E17 9804	2.101			
9EL 137 307-001	E1 273	2.72	9EL 964 531-001	E17 9801	2.101			
9EL 137 307-001	E1 63230	2.72	9EL 964 532-001	E17 9805	2.99			
9EL 137 308-001	E1 273	2.72	9EL 964 533-001	E17 9802	2.102			
9EL 137 308-001	E1 63230	2.72	9EL 964 534-001	E17 9803	2.100			
9EL 137 792-011	E13 9385	2.33	9EL 964 536-001	E17 9903	2.98			
9EL 137 792-031	E13 9385	2.34	9EL 990 034-041	E12 6041	2.120			
9EL 141 135-001	E17 804	2.138	9EL 990 142-001	E12 4054	2.54			
9EL 141 135-011	E17 803	2.138	9EL 990 142-001	E12 7133	2.54			
9EL 141 135-021	E17 378	2.138	9EL 990 186-001	E4 6495	1.68, 1.76-1.77			
9EL 141 135-021	E17 789	2.138	9EL 990 267-001	E12 7122	1.73			
9EL 141 135-031	E1 86	2.138	9EL 990 354-011	E4 6542	1.70-1.71			
9EL 141 135-031	E17 378	2.138	9EL 990 354-021	E4 6542	1.70-1.71			
9EL 141 612-001	E17 3806	2.195	9EL 990 354-031	E4 6543	1.70-1.71			
9EL 146 491-001	E1 43370	2.55	9EL 990 354-041	E4 6543	1.70-1.71			
9EL 146 491-001	E17 9401	2.55	9EL 990 632-001	E9 5447	2.47-2.48			
9EL 146 838-001	E1 801	2.08, 2.17, 2.188,	9EL 990 632-011	E9 5447	2.49-2.50			
		2.276-2.277, 2.286	9EL 990 633-031	E4 10162	2.51			
9EL 146 887-001	E4 279	2.08-2.09	9EL 990 633-041	E4 10162	2.51			
9EL 146 887-001	E4 280	2.08-2.09	9EL 997 310-001	E12 3024	2.52			
9EL 146 887-001	E4 4039	2.08-2.09	9EL 997 310-001	E12 6081	2.52			
9EL 147 096-001	E6 450	2.35	9EL 997 310-001	E12 7111	2.52			
9EL 147 096-001	E6 451	2.35	9EL 997 332-001	E8 71-26	2.55			
9EL 147 096-001	E6 452	2.35	9EL 997 332-001	E8 71-27	2.55			
9EL 147 096-001	E6 453	2.35	9EL 997 332-001	E8 71-28	2.55			
9EL 147 097-001	E6 1375	2.35	9EL 997 387-001	E12 7048	2.139			
9EL 147 097-001	E6 450	2.35	9EL 997 451-001	E12 4038	2.53			
9EL 147 097-001	E6 451	2.35	9EL 997 451-001	E12 6072	2.53			
9EL 147 097-001	E6 452	2.35	9EL 997 451-001	E12 7098	2.53			
9EL 147 747-001	E1 264	2.36, 2.285	9EL 997 452-001	E12 4038	2.53			
9EL 147 747-007	E1 264	2.36	9EL 997 452-001	E12 6072	2.53			
9EL 147 910-001	E1 291	2.142, 2.269	9EL 997 452-001	E12 7098	2.53			
9EL 147 910-001	E1 31410	2.142, 2.269	9EL 997 453-001	E12 3021	2.46			
9EL 147 992-001	E1 02350	2.52	9EL 997 453-001	E12 6077	2.46			
9EL 147 992-001	E1 63255	2.52	9EL 997 453-001	E12 7103	2.46			
9EL 148 274-001	E1 21682	2.142, 2.264	9EL 997 459-001	E12 6085	2.69			
9EL 148 274-001	E1 31410	2.142, 2.264	9EL 997 459-001	E12 7113	2.69			
9EL 150 965-001	E17 9701	2.19	9EL 997 469-001	E12 6089	2.69			
9EL 150 966-001	E17 9701	2.19	9EL 997 469-001	E12 7114	2.69			
9EL 152 884-001	E4 3178	2.12, 2.292	9EM 128 229-011	E1 22786	2.104			
9EL 152 884-001	E4 4060	2.12, 2.292	9ES 012 060-011	K 11103/1	1.69			
9EL 152 884-001	E4 9808	2.12, 2.292	9ES 015 675-001	K 21032	1.69			
9EL 152 884-001	E4 9811	2.12, 2.292	9ES 015 675-001	K 21037	1.69			
9EL 152 889-001	E4 3178	2.09-2.10,	9ES 106 588-001	E1 8704	2.89, 2.307			
		2.289-2.290	9ES 120 743-001	E1 24496	1.67			
9EL 152 889-001	E4 4060	2.09-2.10,	9ES 120 743-001	E1 24540	1.67			
		2.289-2.290	9GP 003 995-801	E4 23215	2.21-2.23, 2.36,			
9EL 152 889-001	E4 9808	2.09-2.10,			2.285, 2.287			
		2.289-2.290	9GP 003 995-801	E4 377	2.21-2.23, 2.36,			
9EL 152 889-001	E4 9810	2.09-2.10,			2.285, 2.287			
		2.289-2.290	9GP 003 995-801	E4 3880	2.21-2.23, 2.36,			
9EL 152 891-001	E4 3179							





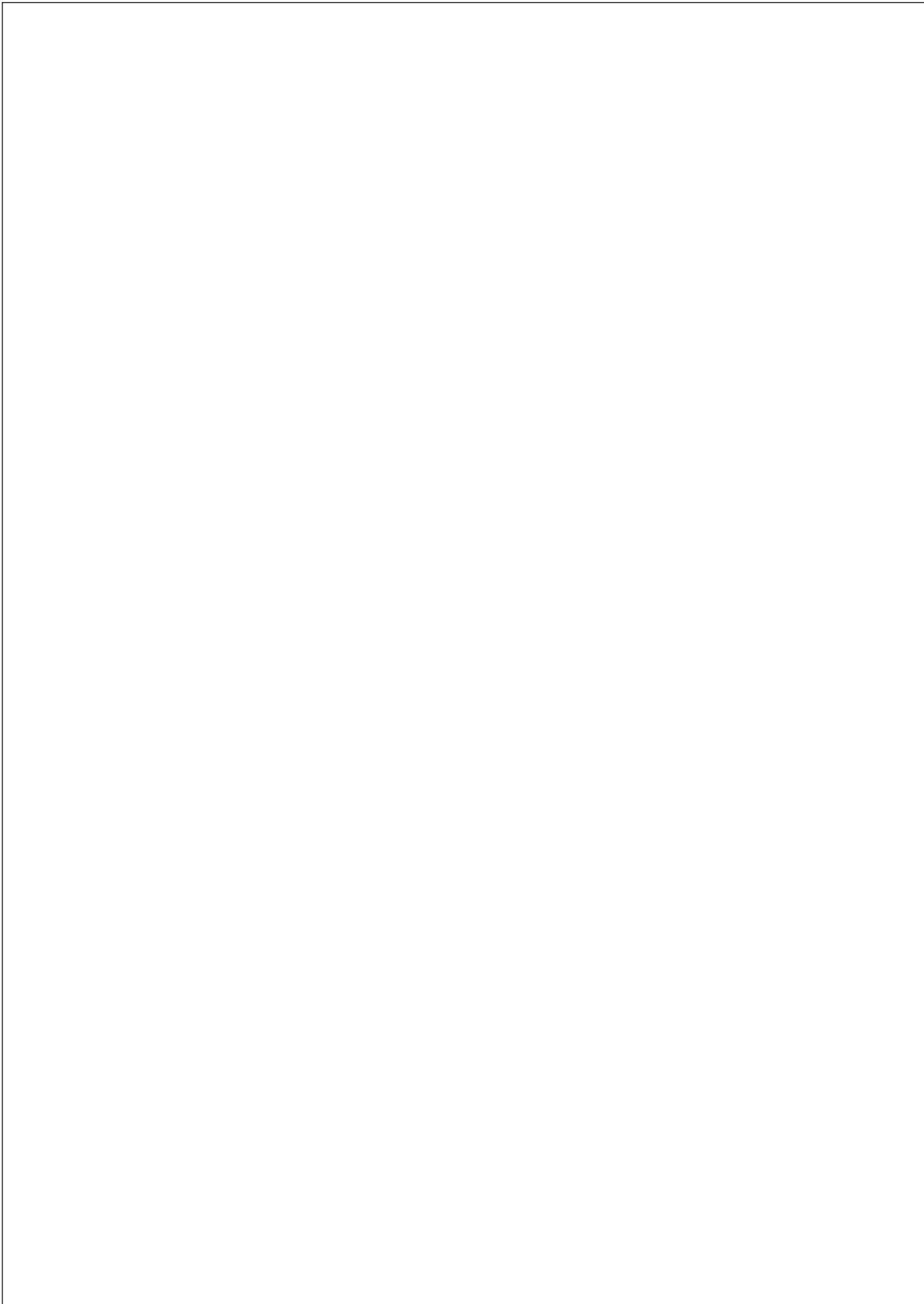

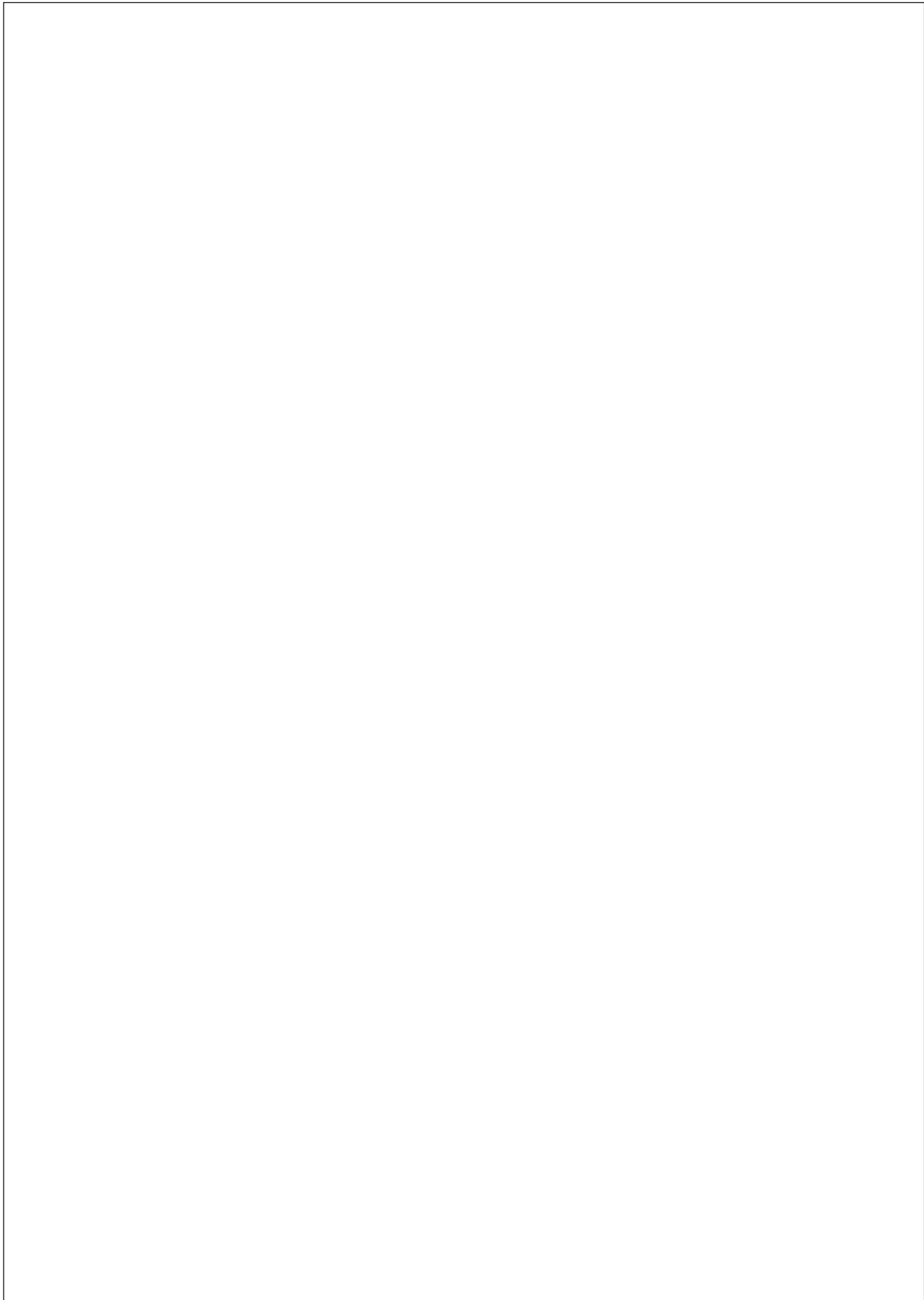

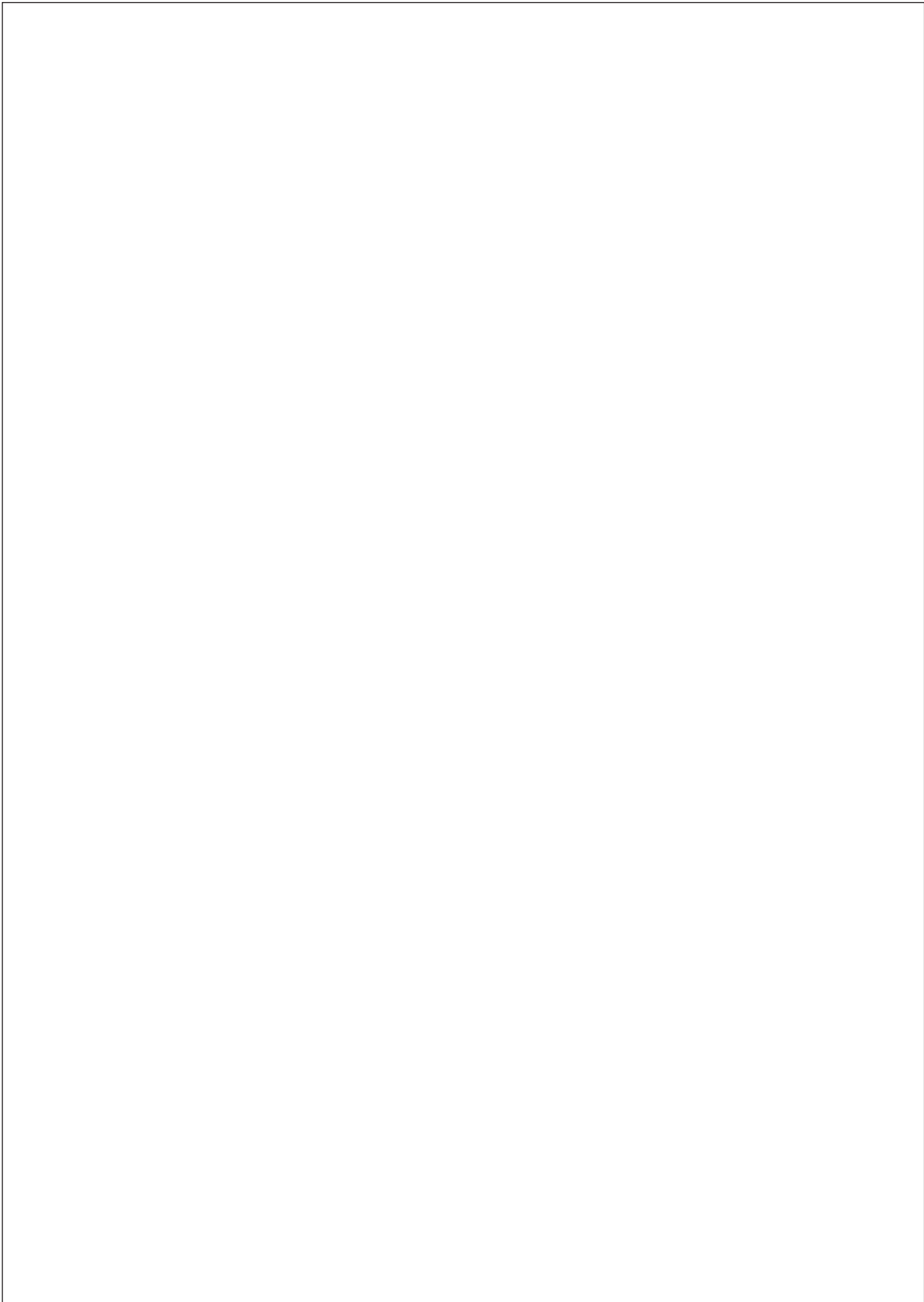







ONLINE PORTAL HELLA TECH WORLD



24/7



FREE



UP-TO-DATE



SUCCESSFUL WITH EXPERTISE

We can make your workshop future-proof. In the HELLA TECH WORLD you will find all of our expansive technological knowledge in the key areas of lighting, electrics, electronics, thermal management, brakes and vehicle diagnostics – free of charge, prepared in an interactive

manner, available around the clock and always up-to-date. Register today and begin acquiring the knowledge that will give you a genuine advantage – greater competence and greater success!



www.hella.com/techworld



HELLA KGaA Hueck & Co.

Rixbecker Straße 75
59552 Lippstadt, Germany
Tel.: +49 2941 38-0
Fax: +49 2941 38-7133
Internet: www.hella.com

HELLA Automotive South Africa (Pty) Ltd

P O Box 603
Uitenhage
SOUTH AFRICA
6230
Tel.: +27 (0) 41-996-5700
Fax.: +27 (0) 41-996-5720
<http://www.hella.co.za>

HELLA, Inc.

201 Kelly Drive
P.O. Box 2665
Peachtree City, GA 30269
Toll Free: 1-877-224-3552
Fax: 1-800-631-7575
www.hellausa.com

© HELLA KGaA Hueck & Co., Lippstadt
9Z2 999 137-267 POL/02.16/0.4
Subject to technical and price modifications
Printed in the UK